

**GLASS PASSIVATED SUPER FAST RECTIFIER**

**VOLTAGE RANGE 50 to 600 Volts CURRENT 3.0 Amperes**

**FEATURES**

- \* High reliability
- \* Low leakage
- \* Low forward voltage
- \* High current capability
- \* Super fast switching speed
- \* High surge capability
- \* Good for switching mode circuit

**MECHANICAL DATA**

- \* Case: Molded plastic
- \* Epoxy: Device has UL flammability classification 94V-O
- \* Lead: MIL-STD-202E method 208C guaranteed
- \* Mounting position: Any
- \* Weight: 1.18 g rms

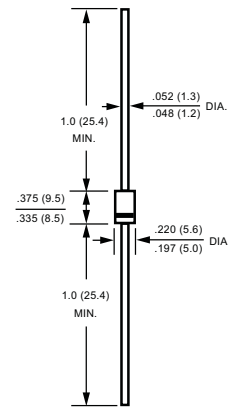

**MAXIMUM RATINGS AND ELECTRICAL CHARACTERISTICS**

Ratings at 25 °C ambient temperature unless otherwise specified.  
resistive or inductive load.

MAXIMUM RATINGS (@ TA=25 °C unless otherwise noted)

RATINGS	SYMBOL	SF31	SF32	SF33	SF34	SF35	SF36	SF37	UNITS
Maximum Recurrent Peak Reverse Voltage	V <sub>RRM</sub>	50	100	150	200	300	400	600	Volts
Maximum RMS Voltage	V <sub>RMS</sub>	35	70	105	140	210	280	420	Volts
Maximum DC Blocking Voltage	V <sub>DC</sub>	50	100	150	200	300	400	600	Volts
Maximum Average Forward Rectified Current at T <sub>A</sub> = 55°C	I <sub>O</sub>	3.0							Amps
Peak Forward Surge Current 8.3 ms single half sine-wave superimposed on rated load (JEDEC method)	I <sub>FSM</sub>	125							Amps
Current Squared Time	I <sup>2</sup> <sub>t</sub>	64.8							A <sup>2</sup> /Sec
Typical Thermal Resistance (Note 3)	R <sub>θJA</sub>	20							°CW
	R <sub>θJL</sub>	8.0							
Typical Junction Capacitance (Note 2)	C <sub>J</sub>	50				30			pF
Operating and Storage Temperature Range	T <sub>J</sub> , T <sub>STG</sub>	-55 to + 150							°C

ELECTRICAL CHARACTERISTICS (@TA=25 °C unless otherwise noted)

CHARACTERISTICS	SYMBOL	SF31	SF32	SF33	SF34	SF35	SF36	SF37	UNITS
Maximum Instantaneous Forward Voltage at 3.0A DC	V <sub>F</sub>	0.95				1.25		1.50	Volts
Maximum DC Reverse Current at Rated DC Blocking Voltage	I <sub>R</sub>	@T <sub>A</sub> = 25°C							uAmps
		@T <sub>A</sub> = 100°C							
Maximum Reverse Recovery Time (Note 1)	t <sub>rr</sub>	35						50	nSec

- NOTES : 1. Test Conditions: I<sub>F</sub> = 0.5A, I<sub>R</sub> = -1.0A, I<sub>RR</sub> = -0.25A  
 2. Measured at 1 MHz and applied reverse voltage of 4.0 volts.  
 3. Typical Thermal Resistance : At 9.5mm lead lengths,PCB mounted.  
 4. "Fully ROHS compliant", "100% Sn plating (Pb-free)"

## RATING AND CHARACTERISTICS CURVES ( SF31 THRU SF37 )

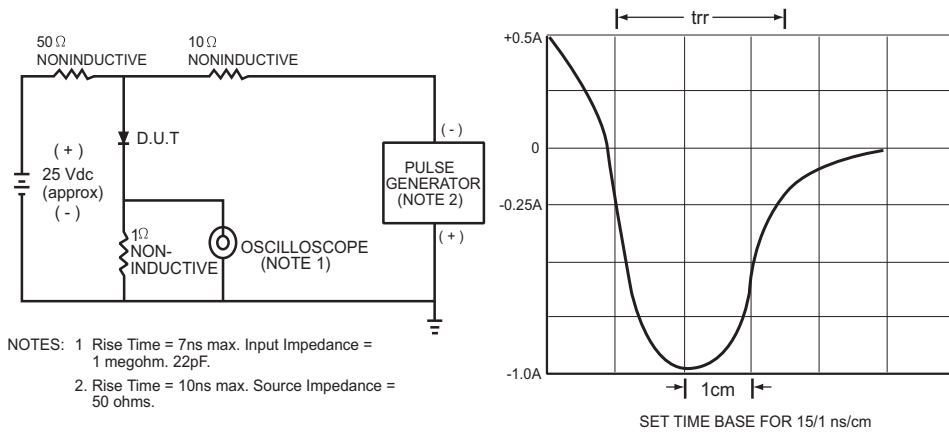

FIG.1 TEST CIRCUIT DIAGRAM AND REVERSE RECOVERY TIME CHARACTERISTIC

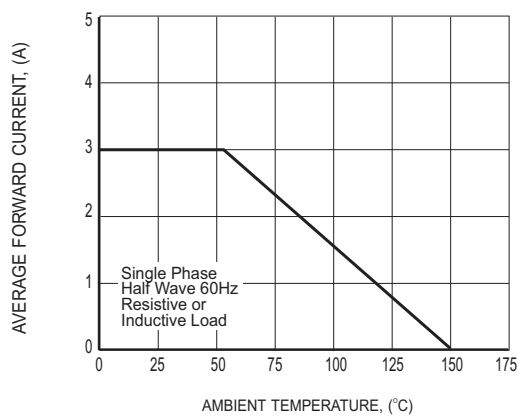

FIG.2 TYPICAL FORWARD CURRENT DERATING CURVE

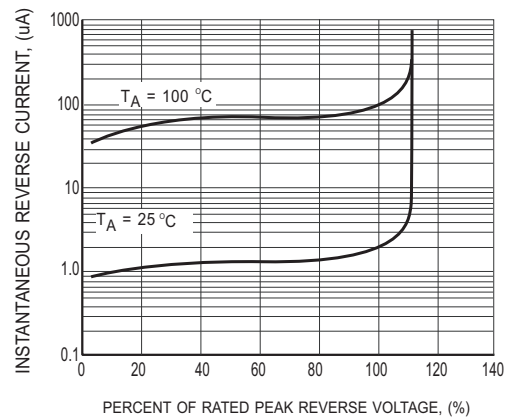

FIG.3 TYPICAL REVERSE CHARACTERISTICS

## RATING AND CHARACTERISTICS CURVES ( SF31 THRU SF37 )

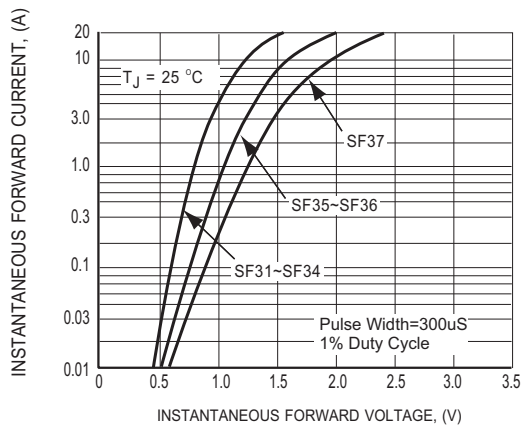

FIG.4 TYPICAL INSTANTANEOUS FORWARD CHARACTERISTICS

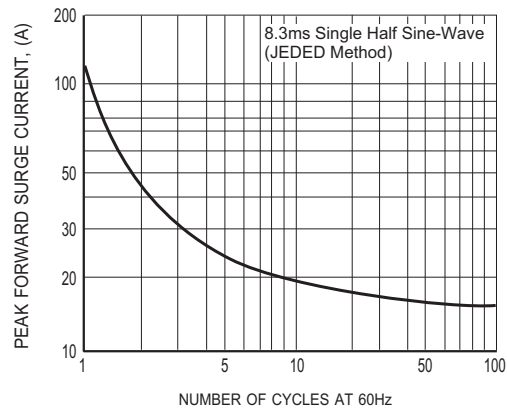

FIG.5 MAXIMUM NON-REPETITIVE FORWARD SURGE CURRENT

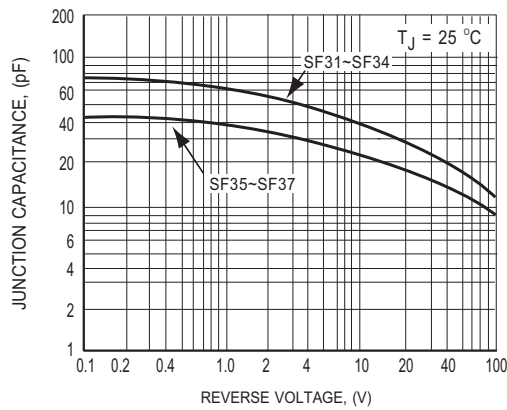
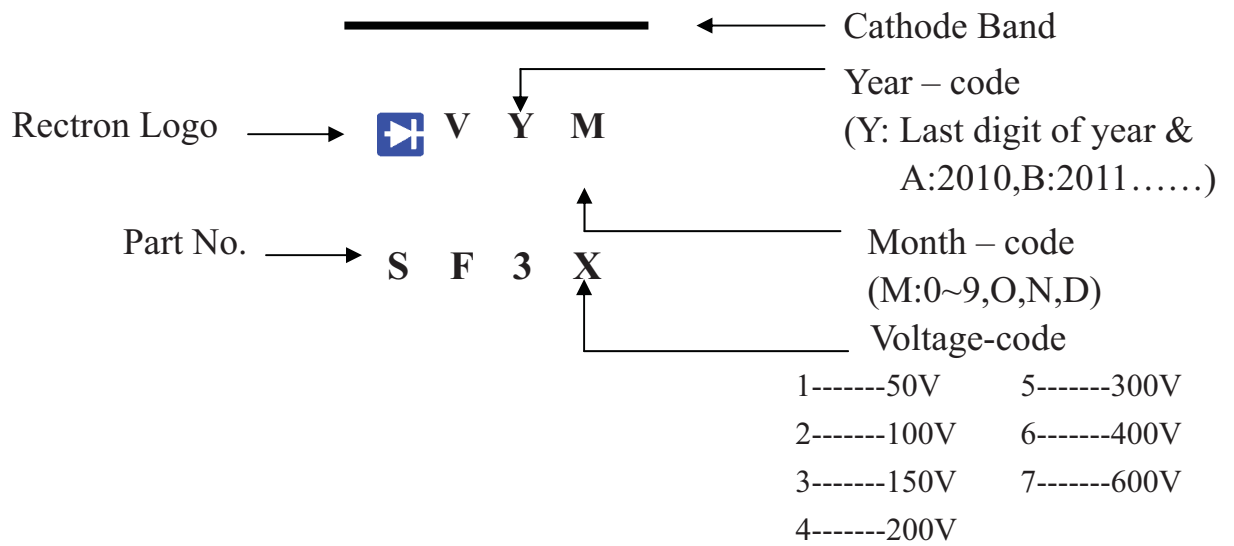

FIG.6 TYPICAL JUNCTION CAPACITANCE

## Marking Description



## PACKAGING OF DIODE AND BRIDGE RECTIFIERS

### BULK PACK

PACKAGE	PACKING CODE	EA PER BOX	INNER BOX SIZE (mm)	CARTON SIZE (mm)	EA PER CARTON	GROSS WEIGHT(Kg)
DO-201	-B	500	300*73*40	347*320*271	12,000	15.9

### REEL PACK

PACKAGE	PACKING CODE	EA PER REEL	EA PER INNER BOX	COMPONENT SPACE (mm)	TAPE SPACE (mm)	REEL DIA (mm)	CARTON SIZE (mm)	EA PER CARTON	GROSS WEIGHT(Kg)
DO-201	-T	1,200	1,200	5.0	52	330	355*350*335	4,800	9.10

### AMMO PACK

PACKAGE	PACKING CODE	REEL ( EA )	COMPONENT SPACE(mm)	TAPE SPACE (mm)	BOX SIZE (mm)	CARTON SIZE(mm)	CARTON ( EA )	GROSS WEIGHT (Kg)
DO-201	-F	600	9.5	52	255*73*100	400*268*225	6,000	9.9