

**GLASS PASSIVATED SUPER FAST RECTIFIER**

**VOLTAGE RANGE 50 to 600 Volts CURRENT 3.0 Amperes**

**FEATURES**

- \* High reliability
- \* Low leakage
- \* Low forward voltage
- \* High current capability
- \* Super fast switching speed
- \* High surge capability
- \* Good for switching mode circuit

**MECHANICAL DATA**

- \* Case: Molded plastic
- \* Epoxy: Device has UL flammability classification 94V-0
- \* Lead: MIL-STD-202E method 208C guaranteed
- \* Mounting position: Any
- \* Weight: 1.18 g rms

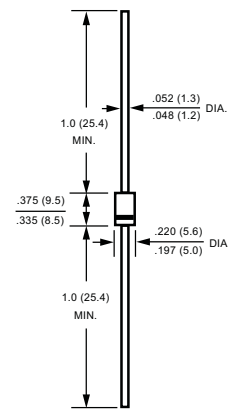

**MAXIMUM RATINGS AND ELECTRICAL CHARACTERISTICS**

Ratings at 25 °C ambient temperature unless otherwise specified.  
resistive or inductive load.

MAXIMUM RATINGS (@ TA=25 °C unless otherwise noted)

| RATINGS   | SYMBOL                            | SF31         | SF32 | SF33 | SF34 | SF35 | SF36 | SF37 | UNITS               |
|---|-----------------------------------|--------------|------|------|------|------|------|------|---------------------|
| Maximum Recurrent Peak Reverse Voltage  | V <sub>RRM</sub>                  | 50           | 100  | 150  | 200  | 300  | 400  | 600  | Volts               |
| Maximum RMS Voltage   | V <sub>RMS</sub>                  | 35           | 70   | 105  | 140  | 210  | 280  | 420  | Volts               |
| Maximum DC Blocking Voltage   | V <sub>DC</sub>                   | 50           | 100  | 150  | 200  | 300  | 400  | 600  | Volts               |
| Maximum Average Forward Rectified Current at T <sub>A</sub> = 55°C                                | I <sub>O</sub>                    | 3.0          |      |      |      |      |      |      | Amps                |
| Peak Forward Surge Current 8.3 ms single half sine-wave superimposed on rated load (JEDEC method) | I <sub>FSM</sub>                  | 125          |      |      |      |      |      |      | Amps                |
| Current Squared Time  | I <sup>2</sup> <sub>t</sub>       | 64.8         |      |      |      |      |      |      | A <sup>2</sup> /Sec |
| Typical Thermal Resistance (Note 3)   | R <sub>θJA</sub>                  | 20           |      |      |      |      |      |      | °CW                 |
|   | R <sub>θJL</sub>                  | 8.0          |      |      |      |      |      |      |                     |
| Typical Junction Capacitance (Note 2)   | C <sub>J</sub>                    | 50           |      |      |      | 30   |      |      | pF                  |
| Operating and Storage Temperature Range   | T <sub>J</sub> , T <sub>STG</sub> | -55 to + 150 |      |      |      |      |      |      | °C                  |

ELECTRICAL CHARACTERISTICS (@TA=25 °C unless otherwise noted)

| CHARACTERISTICS   | SYMBOL          | SF31                    | SF32 | SF33 | SF34 | SF35 | SF36 | SF37 | UNITS |
|---|-----------------|-------------------------|------|------|------|------|------|------|-------|
| Maximum Instantaneous Forward Voltage at 3.0A DC        | V <sub>F</sub>  | 0.95                    |      |      |      | 1.25 |      | 1.50 | Volts |
| Maximum DC Reverse Current at Rated DC Blocking Voltage | I <sub>R</sub>  | @T <sub>A</sub> = 25°C  |      |      |      |      |      |      | uAmps |
|   |                 | @T <sub>A</sub> = 100°C |      |      |      |      |      |      |       |
| Maximum Reverse Recovery Time (Note 1)                  | t <sub>rr</sub> | 35                      |      |      |      |      |      | 50   | nSec  |

- NOTES : 1. Test Conditions: I<sub>F</sub> = 0.5A, I<sub>R</sub> = -1.0A, I<sub>RR</sub> = -0.25A  
 2. Measured at 1 MHz and applied reverse voltage of 4.0 volts.  
 3. Typical Thermal Resistance : At 9.5mm lead lengths,PCB mounted.  
 4. "Fully ROHS compliant", "100% Sn plating (Pb-free)"

## RATING AND CHARACTERISTICS CURVES ( SF31 THRU SF37 )

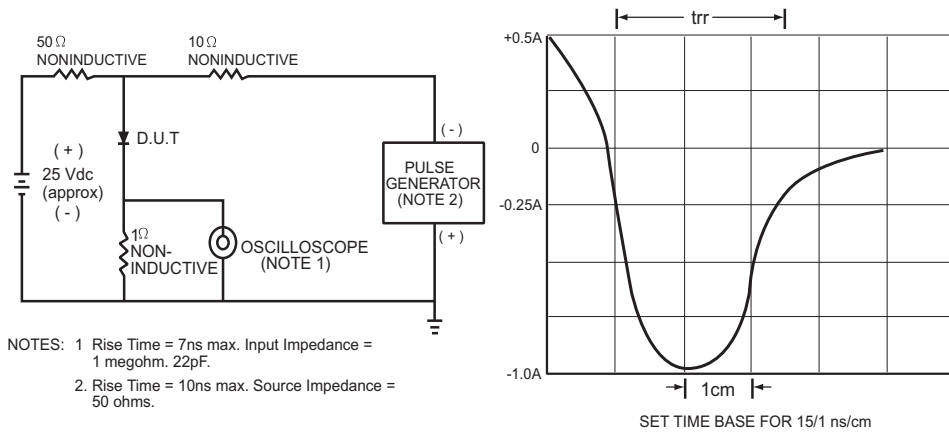

FIG.1 TEST CIRCUIT DIAGRAM AND REVERSE RECOVERY TIME CHARACTERISTIC

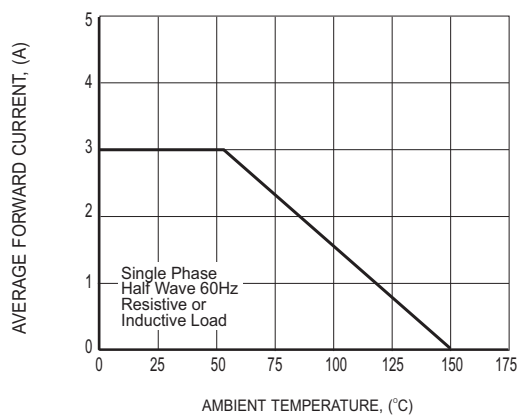

FIG.2 TYPICAL FORWARD CURRENT DERATING CURVE

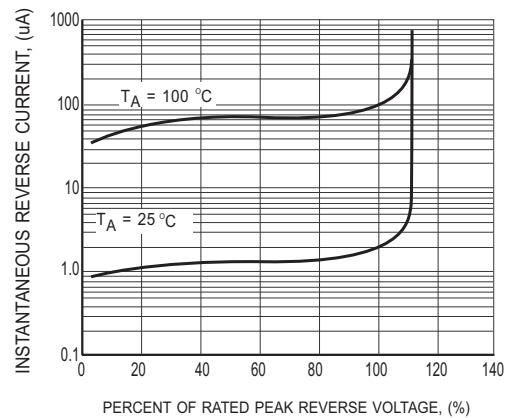

FIG.3 TYPICAL REVERSE CHARACTERISTICS

## RATING AND CHARACTERISTICS CURVES ( SF31 THRU SF37 )

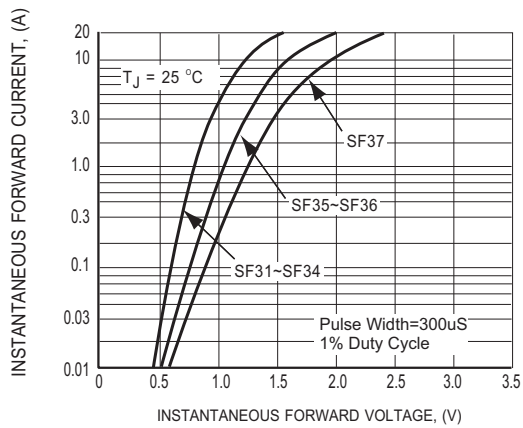

FIG.4 TYPICAL INSTANTANEOUS FORWARD CHARACTERISTICS

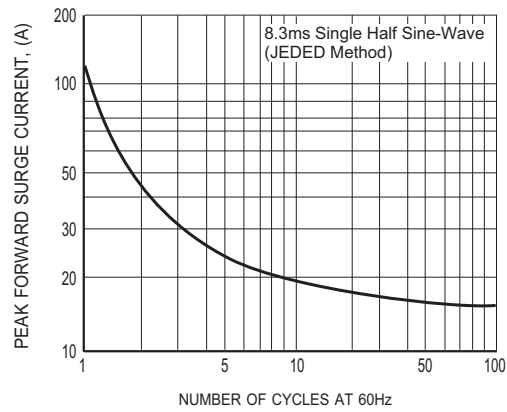

FIG.5 MAXIMUM NON-REPETITIVE FORWARD SURGE CURRENT

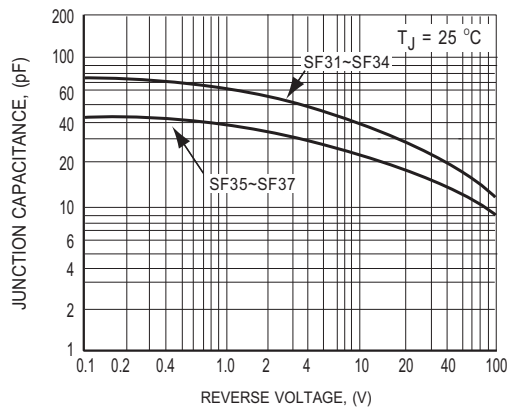
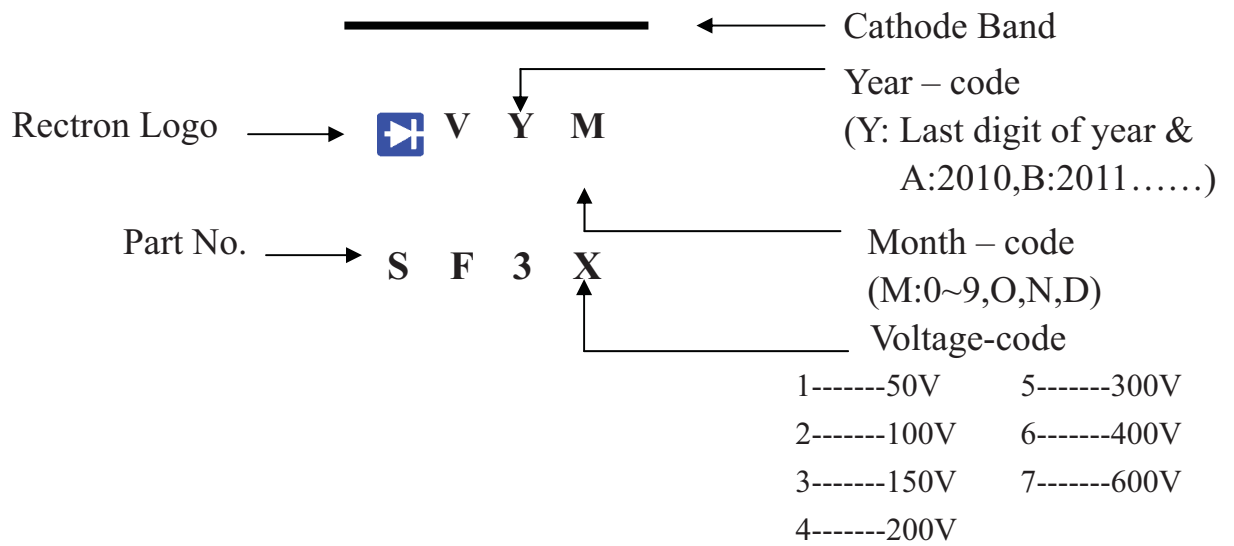

FIG.6 TYPICAL JUNCTION CAPACITANCE

## Marking Description



## PACKAGING OF DIODE AND BRIDGE RECTIFIERS

### BULK PACK

| PACKAGE | PACKING CODE | EA PER BOX | INNER BOX SIZE (mm) | CARTON SIZE (mm) | EA PER CARTON | GROSS WEIGHT(Kg) |
|---------|--------------|------------|---------------------|------------------|---------------|------------------|
| DO-201  | -B           | 500        | 300*73*40           | 347*320*271      | 12,000        | 15.9             |

### REEL PACK

| PACKAGE | PACKING CODE | EA PER REEL | EA PER INNER BOX | COMPONENT SPACE (mm) | TAPE SPACE (mm) | REEL DIA (mm) | CARTON SIZE (mm) | EA PER CARTON | GROSS WEIGHT(Kg) |
|---------|--------------|-------------|------------------|----------------------|-----------------|---------------|------------------|---------------|------------------|
| DO-201  | -T           | 1,200       | 1,200            | 5.0                  | 52              | 330           | 355*350*335      | 4,800         | 9.10             |

### AMMO PACK

| PACKAGE | PACKING CODE | REEL ( EA ) | COMPONENT SPACE(mm) | TAPE SPACE (mm) | BOX SIZE (mm) | CARTON SIZE(mm) | CARTON ( EA ) | GROSS WEIGHT (Kg) |
|---------|--------------|-------------|---------------------|-----------------|---------------|-----------------|---------------|-------------------|
| DO-201  | -F           | 600         | 9.5                 | 52              | 255*73*100    | 400*268*225     | 6,000         | 9.9               |