

**GLASS PASSIVATED SUPER FAST RECTIFIER**

**VOLTAGE RANGE 50 to 600 Volts CURRENT 8.0 Amperes**

**FEATURES**

- \* Low switching noise
- \* Low forward voltage drop
- \* Low thermal resistance
- \* High current capability
- \* Super fast switching speed
- \* High reliability
- \* Good for switching mode circuit

**MECHANICAL DATA**

- \* Case: D-PAK molded plastic
- \* Epoxy: Device has UL flammability classification 94V-0
- \* Lead: MIL-STD-202E method 208C guaranteed
- \* Mounting position: Any

**MAXIMUM RATINGS AND ELECTRICAL CHARACTERISTICS**

Ratings at 25 °C ambient temperature unless otherwise specified.  
Single phase, half wave, 60 Hz, resistive or inductive load.  
For capacitive load, derate current by 20%.

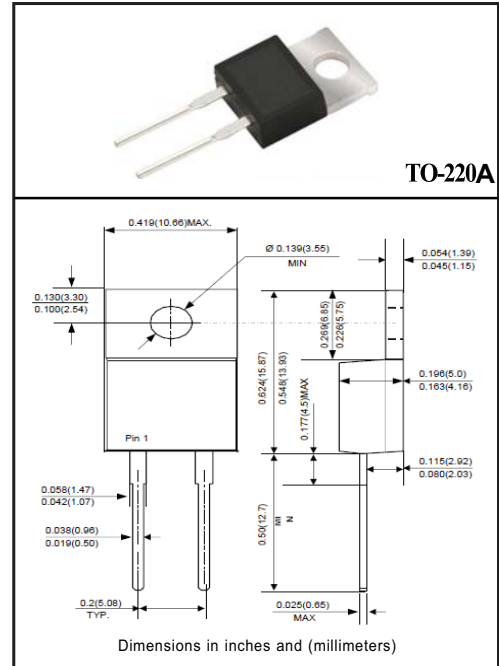

**MAXIMUM RATINGS (@ TA=25 °C unless otherwise noted)**

RATINGS	SYMBOL	SF81	SF82	SF83	SF84	SF85	SF86	SF87	UNITS
Maximum Recurrent Peak Reverse Voltage	V <sub>RRM</sub>	50	100	150	200	300	400	600	Volts
Maximum RMS Voltage	V <sub>RMS</sub>	35	70	105	140	210	280	420	Volts
Maximum DC Blocking Voltage	V <sub>DC</sub>	50	100	150	200	300	400	600	Volts
Maximum Average Forward Rectified Current at T <sub>C</sub> = 100°C	I <sub>O</sub>	8.0							Amps
Peak Forward Surge Current 8.3 ms single half sine-wave superimposed on rated load (JEDEC method)	I <sub>FSM</sub>	150							Amps
Typical Current Squarad Time	I <sup>2</sup> t	93.37							A <sup>2</sup> /Sec
Typical Thermal Resistance (Note 1)	R <sub>θJC</sub>	3							°C/W
	R <sub>θJA</sub>	20							
Typical Junction Capacitance (Note 2)	C <sub>J</sub>	150							pF
Operating and Storage Temperature Range	T <sub>J</sub> , T <sub>STG</sub>	-55 to + 150							°C

**ELECTRICAL CHARACTERISTICS (@TA=25 °C unless otherwise noted)**

CHARACTERISTICS	SYMBOL	SF81	SF82	SF83	SF84	SF85	SF86	SF87	UNITS
Maximum Instantaneous Forward Voltage at 8.0A DC	V <sub>F</sub>	1.0				1.35		1.70	Volts
Maximum DC Reverse Current at Rated DC Blocking Voltage	I <sub>R</sub>	@T <sub>A</sub> = 25°C							uAmps
		@T <sub>A</sub> = 100°C							
Maximum Reverse Recovery Time (Note 3)	t <sub>rr</sub>	35				50		nSec	

- NOTES : 1. Thermal Resistance : Heat-sink case mounted or if PCB mounted.  
2. Measured at 1 MHz and applied reverse voltage of 4.0 volts.  
3. Test conditions: I<sub>F</sub> = 0.5A, I<sub>R</sub> = -0.1A, I<sub>RR</sub> = -0.25A.  
4. "Fully ROHS compliant", "100% Sn plating (Pb-free)".  
5. Suffix "R" for Reverse Polarity.  
6. Suffix "I" for ITO-220A Pkg.

## RATING AND CHARACTERISTICS CURVES ( SF81 THRU SF87 )

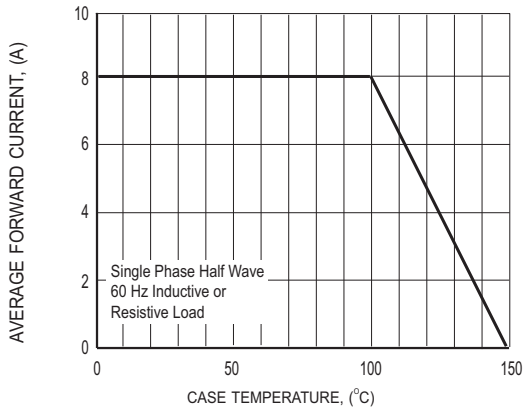

**FIG.1 TYPICAL FORWARD CURRENT DERATING CURVE**

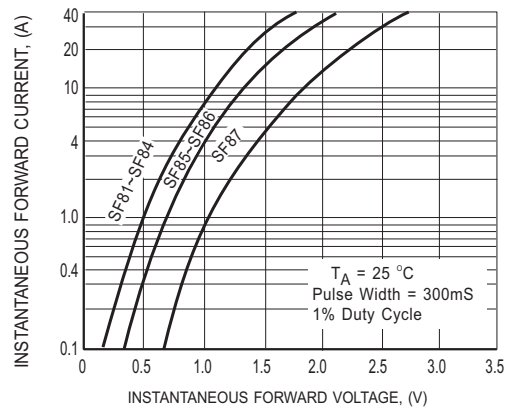

**FIG.2 TYPICAL INSTANTANEOUS FORWARD CHARACTERISTICS**

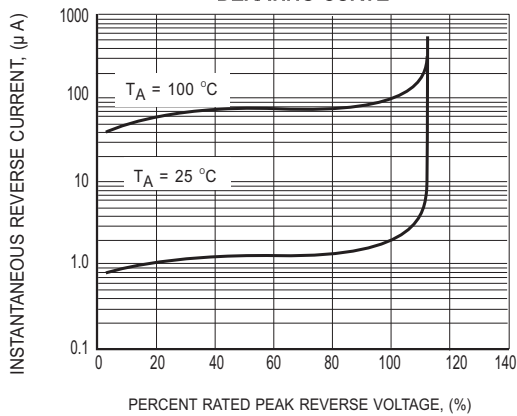

**FIG.3 TYPICAL REVERSE CHARACTERISTICS**

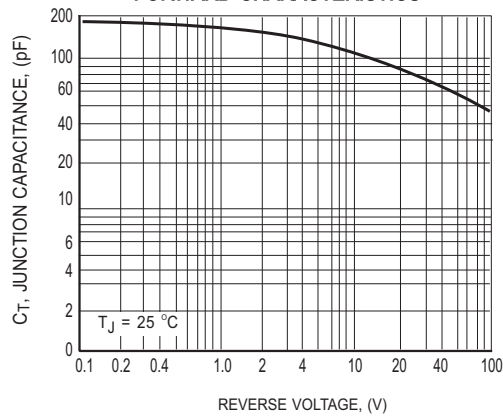

**FIG.4 TYPICAL JUNCTION CAPACITANCE**

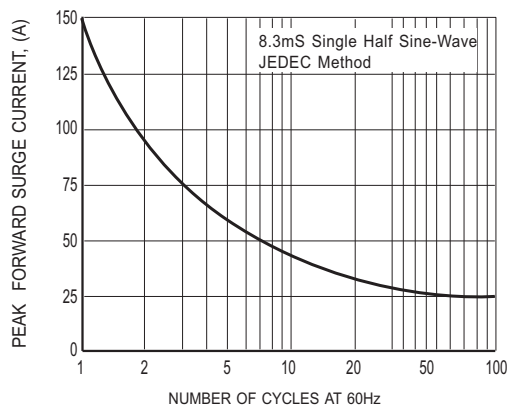
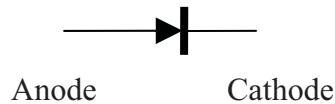

**FIG.5 MAXIMUM NON-REPETITIVE FORWARD SURGE CURRENT**



## Attachment information about SF8X

### 1. Internal Circuit



### 2. Marking on the body

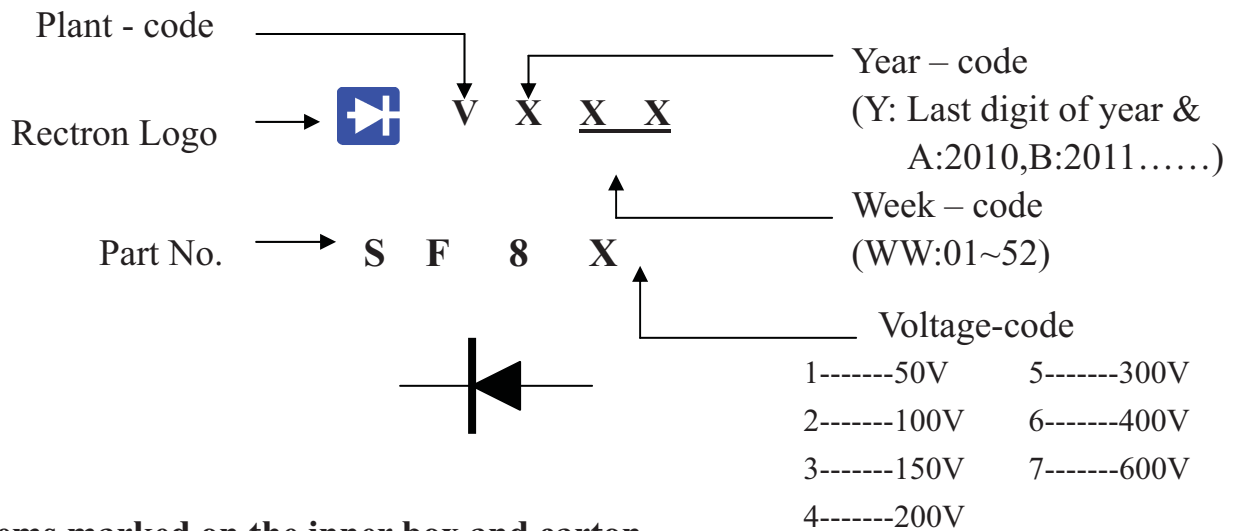

### 3. Items marked on the inner box and carton

#### 3.1 On the box (for -C)

CUSTOMER  
 TYPE  
 LOT NO.  
 QUANTITY  
 Q.A.  
 DATE

#### 3.2 On the carton

CUSTOMER  
 TYPE  
 QUANTITY  
 LOT NO.  
 REMARK

# PACKAGING OF DIODE AND BRIDGE RECTIFIERS

## TUBE PACK

PACKAGE	PACKING CODE	EA PER BOX	INNER BOX SIZE (mm)	CARTON SIZE (mm)	EA PER CARTON	WEIGHT(Kg)
(I)TO-220/TO-220A	-C	1,000	555*150*40	580*230*175	5,000	15.0