

SFT-20 LED Chipset in SMT and Starboard Configurations

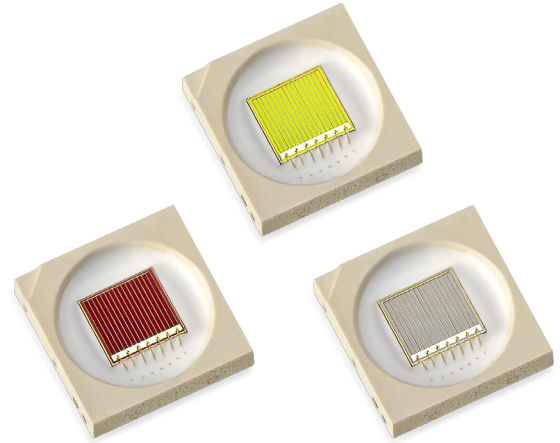

Table of Contents

Technology Overview2

Understanding SMT Test Specifications.....2

Ordering / Bin Kits.....3-5

Standard Test Condition6

Optical & Electrical Characteristics7

Absolute Maximums8

Parametric Graphs 9-12

Thermal Resistance 13

Mechanical Dimensions13-15

Solder Profile 16

Packing and Shipping Specifications 17-18

History of Changes 19

Features:

- Matched R/CG/B chipset with 2.0mm² emitting area designed for high current density 0.2 / 0.3" Pico projection applications
- Thermally efficient Surface Mount (SMT) Package: $R_{th_{J-B}} = 1.0^{\circ}C/W$
- Available either in "Standard" (SMT) or Pre-Mounted "Starboard" Configurations.
- Available "Starboard" Packaging Configuration allows ease of evaluation and/or immediate system integration.
- 100% surface emission for high collection efficiency and low optical losses
- Wide color gamut with the most optimal dominant wavelengths: Red-Amber 613nm, Converted Green (filtered spectrum) 555nm, and Blue 455nm
- Single emitting area per color allows for efficiency of collection with simplified optics
- Environmentally friendly: RoHS and REACH compliant
- Characterized correlation available for Projection applications.

Applications

- Specifically engineered for stand alone, embedded, or battery-assisted projection display applications.
- Entertainment / Stage Lighting
- Medical / Life Science
- Industrial
- Emergency Lighting / Beacons / Obstruction Lighting.
- High Brightness General Lighting

Technology Overview

Luminus Devices' SFT series of illuminators is an innovative light source created for applications requiring high current density in a small area. With its thermally efficient package, the SFT-20 chipset allows the end-product to deliver all the benefits of small, high performing solid state light sources.

In Projection Display applications, The SFT series is environmentally friendly (Mercury-free), enables instant start and re-start with no wait time, high reliability, and long life requiring no end-user or field replacement. Response time is extremely fast to enable frame-by-frame color control in compatible systems.

Innovative Packaging Technology

Thermal management is critical in high power LED applications. With its low thermal resistance the SFT-20 can be driven at higher current densities while maintaining a low junction temperature. This results in brighter solutions and longer lifetimes.

Reliability

The SFT-20 has passed a rigorous suite of environmental and mechanical stress tests, including mechanical shock, vibration, temperature cycling and humidity. It is fully qualified for use in high power / small form factor / high current display applications.

With very low failure rates and median lifetimes that typically exceed 60,000 hours, Luminus SFT-Series of LEDs are ready for even the most demanding applications. (Please refer to Luminus' Reliability application note for more information.)

Environmental Benefits

Luminus LEDs help reduce power consumption and the amount of hazardous waste entering the environment. All LED products manufactured by Luminus are RoHS and REACH compliant and contain no lead or mercury.

Understanding SMT Test Specifications

Every Luminus LED is tested to ensure that it meets the high quality standards expected from Luminus' products.

Testing of SMT LEDs

The Luminus SFT series of products are measured in such a way that allows high volume / fast paced production while providing an accurate measurement that correlates with real world operating conditions.

Luminus makes available correlation curves (page 8) that allows the designer to predict with a high-level of accuracy the performance that is to be expected in a typical "Display" application.

Ordering Information (SMT Configuration)^{1,2}

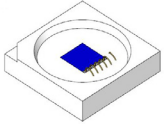
Ordering Part Number	Color	Min Flux Bin	Description	Configuration
SFT-20-RA-F35-MPA	Red Amber	1A	Red-Amber LED consisting of a 2.0 mm ² die mounted on a small 3.5 x 3.5mm high-performance package with directional indicator.	
SFT-20-CG-F35-MPB	Converted Green	2B	Converted Green consisting of a 2.0 mm ² die die mounted on a small 3.5 x 3.5mm high-performance package. Includes directional indicator.	
SFT-20-CG-F35-MPC		2C		
SFT-20-B-F35-EPB	Blue	4B	Blue LED consisting of a 2.0 mm ² die mounted on a small 3.5 x 3.5mm high-performance package with directional indicator.	
SFT-20-B-F35-EPC		4C		

Ordering Information (Starboard Configuration)^{1,2,3}

Ordering Part Number	Color	Min Flux Bin	Description	Configuration
SFT-20-RA-R35-MPA	Red Amber	1A	Red-Amber LED consisting of a 2.0 mm ² die in a small 3.5 x 3.5mm package mounted on a thermally efficient and pedestal, common cathode designed starboard.	
SFT-20-CG-R35-MPB	Converted Green	2B	Converted Green LED consisting of a 2.0 mm ² die with Green Phosphor Platelet in a small 3.5 x 3.5mm package mounted on a thermally efficient and pedestal, common cathode designed starboard.	
SFT-20-CG-R35-MPC		2C		
SFT-20-B-R35-EPB	Blue	4B	Blue LED consisting of a 2.0 mm ² die in a small 3.5 x 3.5mm package mounted on a thermally efficient and pedestal, common cathode designed starboard.	
SFT-20-B-R35-EPC		4C		

Note 1: Ordering part numbers represent bin kits (group of bins that are shippable for a given ordering part number)

Note 2: Bin Kits are defined by a group of flux or power bins. Only one flux / power bin will be shipped in each individual pack or reel. Each shipment will contain reels of different allowed bins for a specific orderable part number (See page 5). Individual Flux or Power bins are not orderable.

Note 3: Starboard Configuration are available for sample quantity only. For additional quantity, contact Luminus representative.

Ordering Part Number Nomenclature

SFT — nn — XXXX — XXX — XYZ

Product Family	Chip Area	Color	Package Configuration	Bin Kit ¹
SFT: Surfacemount Flat-Top Windowless	20: 2.0 mm ²	RA = Red - Amber CG= Converted Green B= Blue	F35: 3.5mm x 3.5mm See Mechanical Drawing section R35: SFT-20 mounted on Starboard Starboard only in sample quantity	See page 5 for bin kit definition

Note 1: A Bin Kit represents a group of individual flux or power bins that are shippable for a given ordering part number. Individual flux bins are not orderable.
 EXAMPLES: SFT-20-CG-F35-MPC is comprised of Converted Green Flux Bins 2C through 2F.
 Not all bins are populated by Luminus.

PACKAGE CONFIGURATIONS

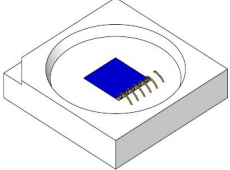
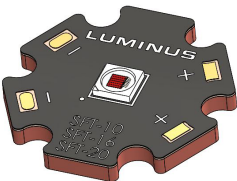
Package Configuration ¹	Type	Picture	Description
F35	SMT		Standard configuration. A 2.0 mm ² die mounted on a small 3.5 x 3.5mm high-performance package with directional indicator.
R35	STARBOARD		Pre-Mounted Configuration. The standard SFT-20 SMT Package pre-mounted on a Luminus thermally efficient and pedestal, common cathode designed copper 19.9 x 19.9mm starboard. See page 15. Starboard only in sample quantity. Contact Luminus representative for additional requirements. Starboard requires electrical isolation in most system designs. Starboard backside is connected to LED cathode.

Note 1:

The packaging configuration must be specified within the orderable part number. If not specified, or invalid, the order may be rejected or default to the "F35" (Standard) configuration.

Ordering Part Number Nomenclature

SFT — **nn** — **XXXX** — **XXX** — **XYZ**

Product Family	Chip Area	Color	Package Configuration	Bin Kit ¹
SFT: Surfacemount Flat-Top Windowless	20: 2.0 mm ²	RA = Red - Amber CG= Converted Green B= Blue	F35: 3.5mm x 3.5mm See Mechanical Drawing section R35: SFT-20 mounted on Starboard Starboard only in sample quantity	See page 5 for bin kit definition

Note 1: A Bin Kit represents a group of individual flux or power bins that are shippable for a given ordering part number. Individual flux bins are not orderable.
EXAMPLES: SFT-20-CG-F35-MPC is comprised of Converted Green Flux Bins 2C through 2F.
Not all bins are populated by Luminus.

SFT-20 Bin Kit¹ and Flux Bin^{3,4} Definitions

Note: The below table outlines what bins are allowed to be shipped under a particular orderable part number.

Red -Amber Flux Bins	Bin 1Z	Bin 1A	Bin 1B	Bin 1C	Bin 1D	Bin 1E	Bin 1F	Bin 1G	Bin 1H	
Red -Amber Bin Flux Range (lm)	160 - 180	180 - 200	200 - 220	220 - 240	240 - 260	260 - 285	285 - 310	310 - 340	340 - 370	
SFT-20-RA-F35-MPA		<input checked="" type="checkbox"/>	<input checked="" type="checkbox"/>	<input checked="" type="checkbox"/>	<input checked="" type="checkbox"/>	<input checked="" type="checkbox"/>				
Conv Green Flux Bins		Bin 2A	Bin 2B	Bin 2C	Bin 2D	Bin 2E	Bin 2F	Bin 2G	Bin 2H	
Conv Green Bin Flux Range (lm)		400 - 430	430 - 480	480 - 520	520 - 570	570 - 610	610 - 650	650 - 700	700 - 760	
SFT-20-CG-F35-MPB			<input checked="" type="checkbox"/>	<input checked="" type="checkbox"/>	<input checked="" type="checkbox"/>	<input checked="" type="checkbox"/>				
SFT-20-CG-F35-MPC				<input checked="" type="checkbox"/>	<input checked="" type="checkbox"/>	<input checked="" type="checkbox"/>	<input checked="" type="checkbox"/>			
Blue Power Bins		Bin 4A	Bin 4B	Bin 4C	Bin 4D	Bin 4E	Bin 4F	Bin 4G	Bin 4H	
Blue Optical Power Range (Radiometric Watts)		1.30 - 1.40	1.40 - 1.55	1.55 - 1.70	1.70 - 1.90	1.90 - 2.10	2.10 - 2.30	2.30 - 2.50	2.50 - 2.75	
SFT-20-B-F35-EPB			<input checked="" type="checkbox"/>	<input checked="" type="checkbox"/>	<input checked="" type="checkbox"/>	<input checked="" type="checkbox"/>				
SFT-20-B-F35-EPC				<input checked="" type="checkbox"/>	<input checked="" type="checkbox"/>	<input checked="" type="checkbox"/>	<input checked="" type="checkbox"/>			

Wavelength Dominant Bin² Definitions

Color	Bin	Minimum WLD (nm)	Maximum WLD (nm)
Red-Amber	R1	609	615
Red-Amber	R2	615	621
Blue	B1	449	455
Blue	B2	455	460

Note 1: Bin Kits are defined by a group of flux or power bins. Only one flux / power bin will be shipped in each individual pack or reel. Each shipment will contain packs (or reels) of different allowed bins for a specific orderable part number. Individual Flux or Power bins are not orderable.

Note 2: Wavelength bins are not orderable. Wavelength bins are displayed in product label.

Note 3: SFT-20 LEDs are tested according to the process outlined on page 6. Devices are sorted and packaged in reels by flux bin. Not all flux bins are currently populated.

Note 4: Luminus maintains a test measurement accuracy for LED flux and power of +/- 6%.

STANDARD TEST CONDITION

All performance metrics of the SFT-Series of LED's are characterized from a single current "PULSE"^{1,2,3}

The typical pulse duration is 20ms, and the applied current is 1.4A.

Rise and Fall times of the signal are negligible.

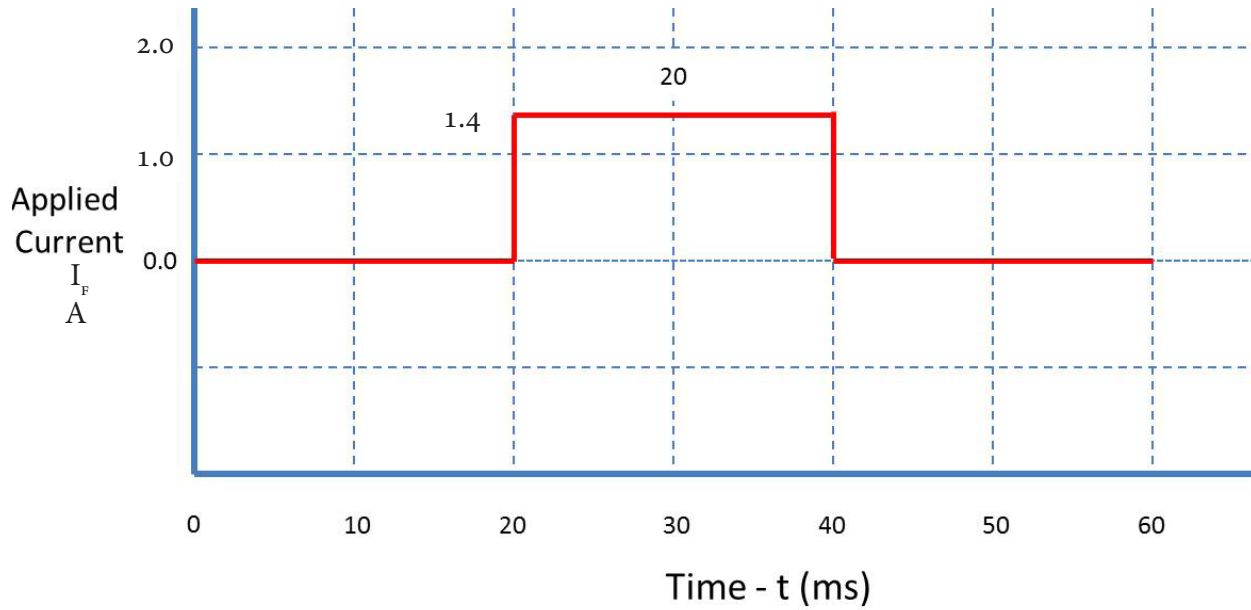

Note 1: Environmental temperature is assumed to be Ambient. (25C typ)

Note 2: Due to the brief nature of this test, T_j (Juncton Temperature) is assumed to be ambient or approx 25C.

Note 3: Luminus maintains a tolerance of +/- 6% on all flux or radiometric power measurements

Optical & Electrical Characteristics

General Characteristics		Symbol	Red -Amber	Converted Green	Blue	Unit
Emitting Area			2.0	2.0	2.0	mm ²
Emitting Area Dimensions			1.30 x 1.55	1.31 x 1.55	1.30 x 1.55	mm x mm
Performance at Standard Test Conditions (See definition on p5)						
Peak Luminous Flux ^{1,6}	typ	Φ_v	240	520	80	lm
Peak Radiometric Flux ^{1,6}	typ	Φ_r	0.80	1.0	1.7	W
Dominant Wavelength	min	λ_{dmin}	609	545	449	nm
	typ	λ_d	613	555	455	
	max	λ_{dmax}	621	565	461	
FWHM- Spectral bandwidth at 50% of Φ_v	typ		16	98	19	nm
Chromaticity Coordinates ^{4,5}	typ	x	0.66	0.33	0.14	CIE x
	typ	y	0.32	0.56	0.04	CIE y
Forward Voltage	min	V_{Fmin}	2.2	2.5	2.5	V
	typ	V_F	2.5	3.0	3.0	
	max	V_{Fmax}	3.0	3.6	3.6	
Correlated Performance in Typical Display Application (5.0A @ 40C Heatsink Temp @ Specified Duty Cycle) [Reference Only].						
Reference Drive Current	typ	I_F	5.0	5.0	5.0	A
Reference Duty Cycle	typ		25	50	25	%
Luminous Flux ^{1,6}	typ	Φ_v	600	1350	200	lm
Radiometric Flux ^{1,6}	typ	Φ_r	2.2	2.8	4.2	W
Dominant Wavelength	typ	λ_d	613	555	453	nm
FWHM -Spectral bandwidth at 50% of Φ_v	typ		15	99	19	
Chromaticity Coordinates ⁴	typ	x	0.66	0.32	0.14	CIE x
			0.33	0.55	0.04	CIE y
Forward Voltage	typ	V_F	3.6	3.5	3.4	V

Note 1: Luminus maintains a tolerance of +/- 6% on flux measurements

Note 2: Duty Cycle used to specify device ratings under Pulsed operation. SFT-Series of LEDs can operate at duty cycles ranging from 1% to 100%. At higher duty cycles, drive current should be adjusted to maintain the junction temperature at desired levels to meet the application lifetime requirements.

Note 3: In pulsed operation, rise time from 10 to 90% of forward current should be larger than 0.5 microseconds.

Note 4: CIE 1931 chromaticity diagram coordinates, normalized to X+Y+Z=1.

Note 5: For Reference only.

Note 6: For Reference only, actual received performance will depend on customer's ordering part number.

Optical & Electrical Characteristics

Absolute Maximum Ratings

	Symbol	Red - Amber	Converted Green	Blue	Unit
Absolute Minimum Current (CW or Pulsed) ¹		400	400	400	mA
Absolute Maximum Current (CW) ²		5.0	6.0	6.0	A
Absolute Maximum Current (Pulsed) ^{2,3} (Frequency > 240 Hz, duty cycle <70%)		6.0	8.0	8.0	A
Absolute Maximum Surge Current ^{2,3} (Frequency > 240 Hz, duty cycle =10%, t= 1ms)		8.0	8.0	8.0	A
Absolute Maximum Junction Temperature ⁴	T_{jmax}	110	150	150	°C
Storage Temperature Range		-40 / +100	-40 / +100	-40 / +100	°C

Note 1: Product performance and lifetime data is specified at recommended forward drive currents. Sustained operation at or near absolute minimum currents may result in a reduction of device performance and device lifetime compared to recommended forward drive currents.

Note 2: Sustained operation at or above maximum currents is not recommended and will result in a reduction of device lifetime.
Device lifetimes will depend on junction temperature. (See Reliability Application Note, APN-001444 for product lifetimes as function of junction temperature.)
Please refer to lifetime de-rating curves (available from Luminus) for further information.

Note 3: In pulsed operation, rise time from 10 to 90% of forward current should be larger than 0.5 microseconds.

Note 4: Sustained operation at Absolute Maximum Operating Junction Temperature (T_{jmax}) will result in reduced device life time.

Normalized Luminous Flux (Blue: Radiometric Power)

vs. Forward Current ($T_{hs} = 25^{\circ}\text{C}$, $I_f = \text{Pulse}$)

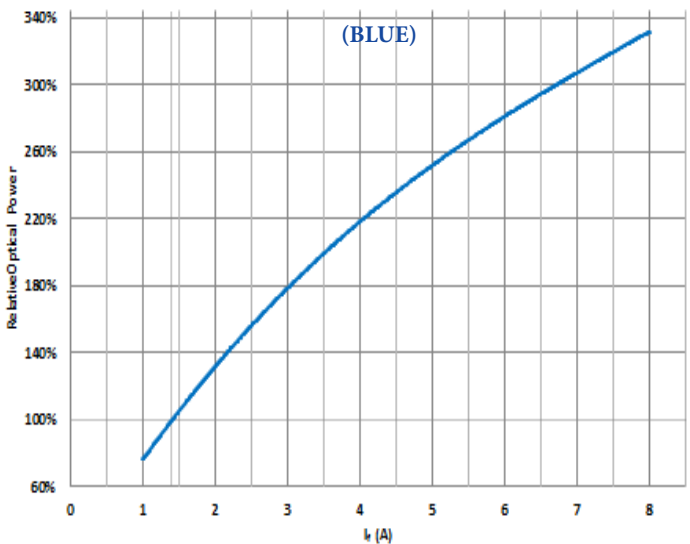
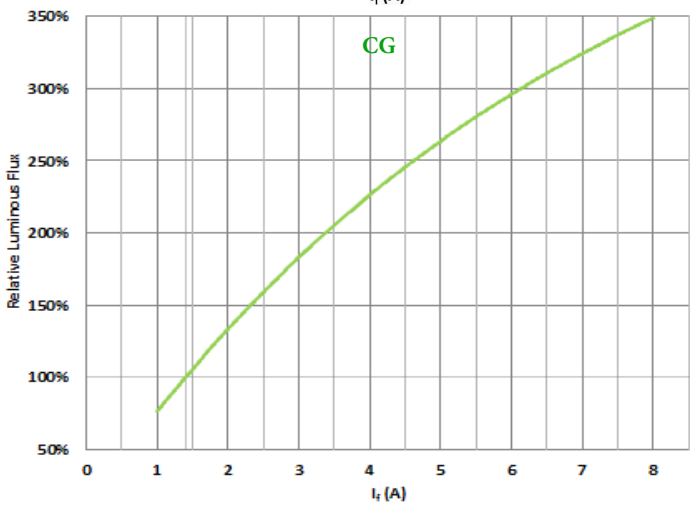
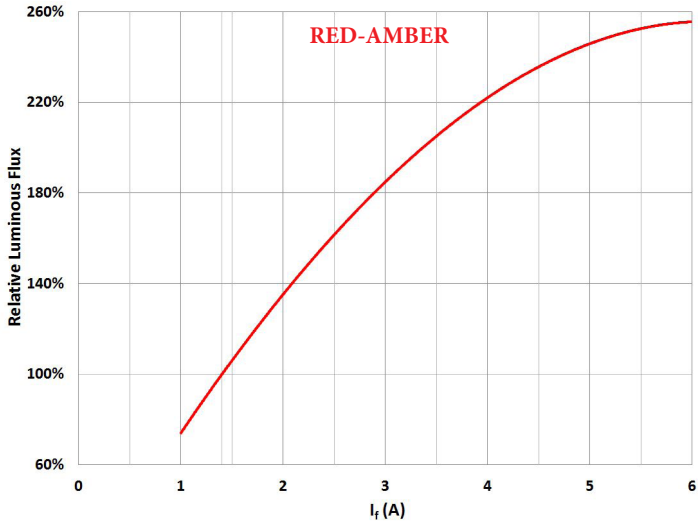

vs. T_j ($I_f = 1.4\text{A Pulse}$)

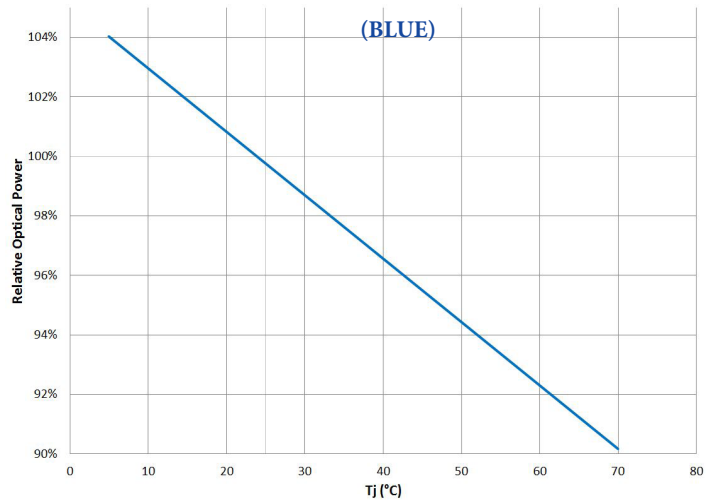
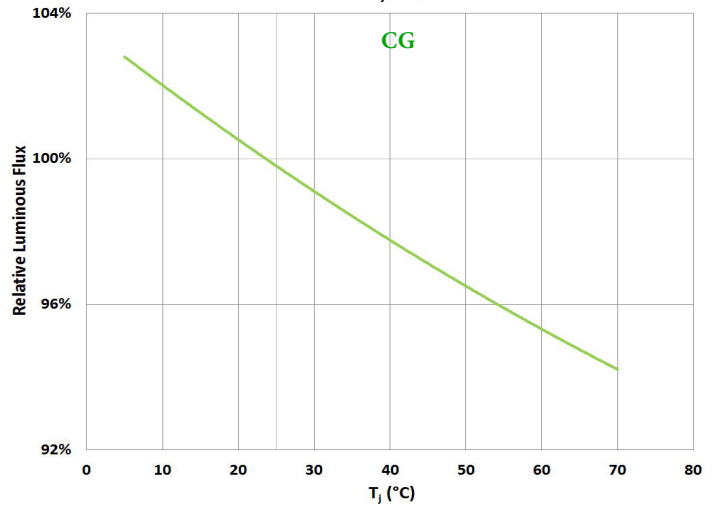
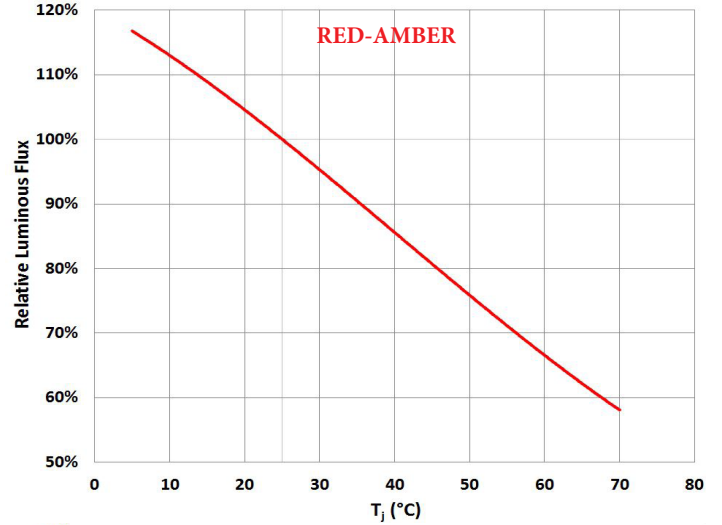

Relative Forward Voltage (V_f) variation

vs. Forward Current ($T_{hs} = 25^\circ\text{C}$, $I_f = \text{Pulse}$)

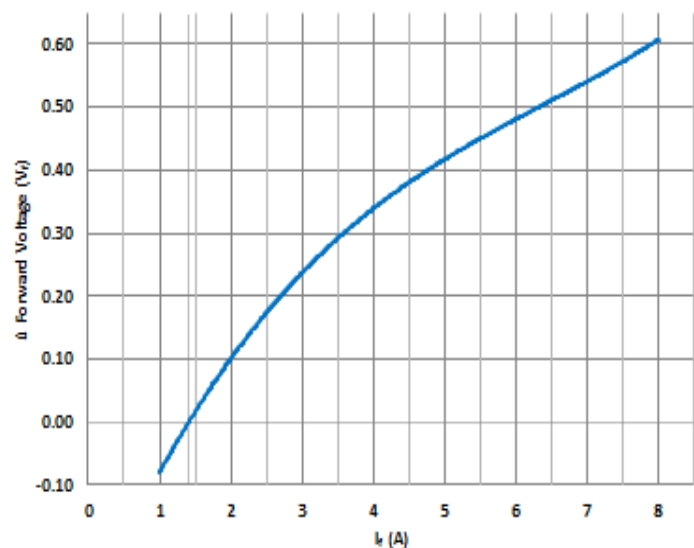
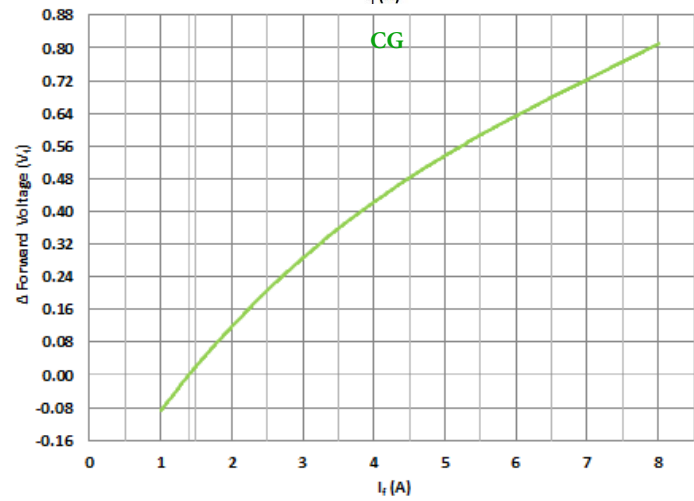
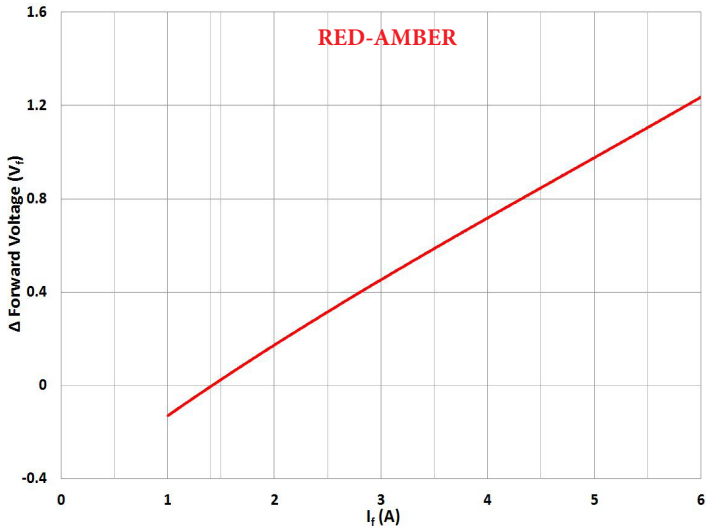

vs. T_j ($I_f = 1.4\text{A Pulse}$)

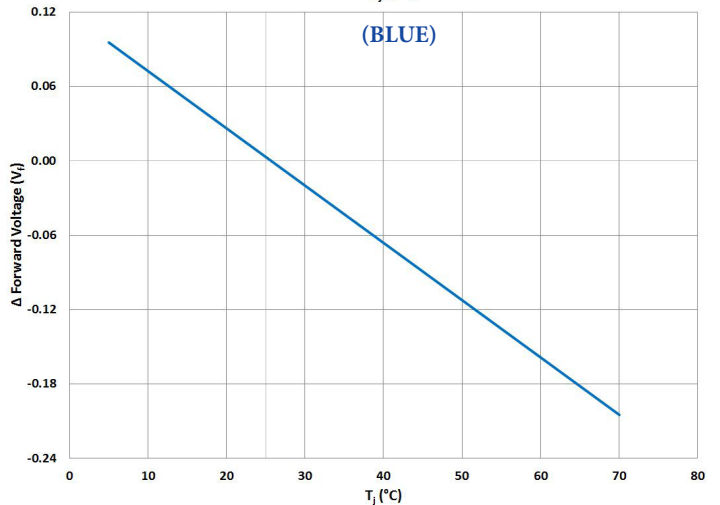
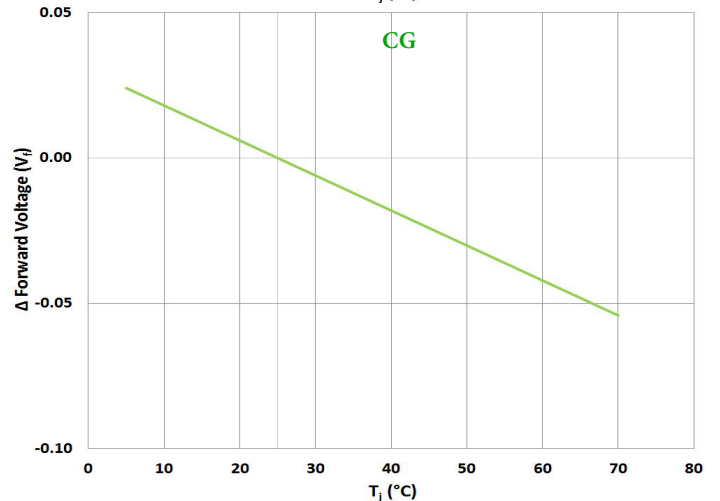
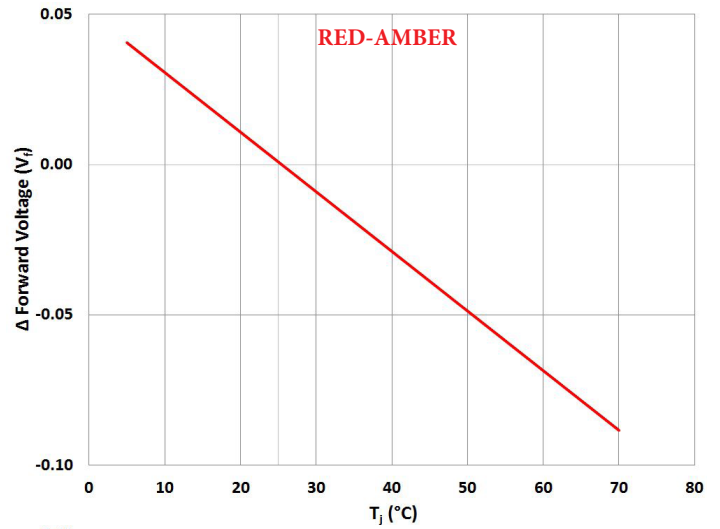

Relative Dominant Wavelength variation

vs. Forward Current ($T_{hs} = 25^{\circ}\text{C}$, $I_f = \text{Pulse}$)

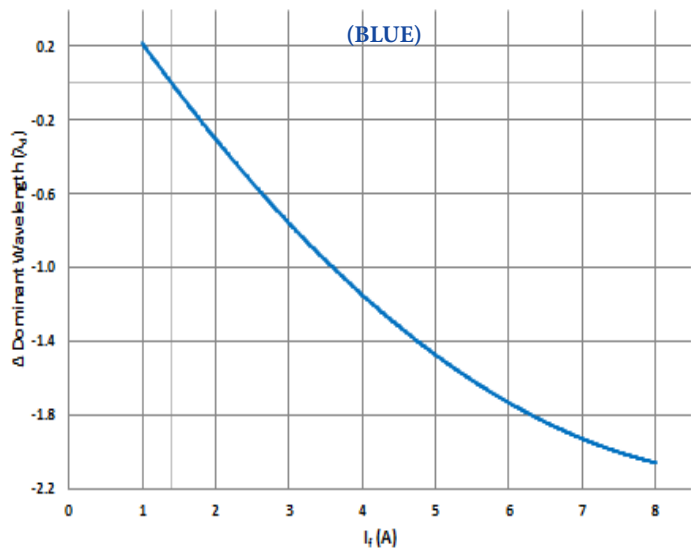
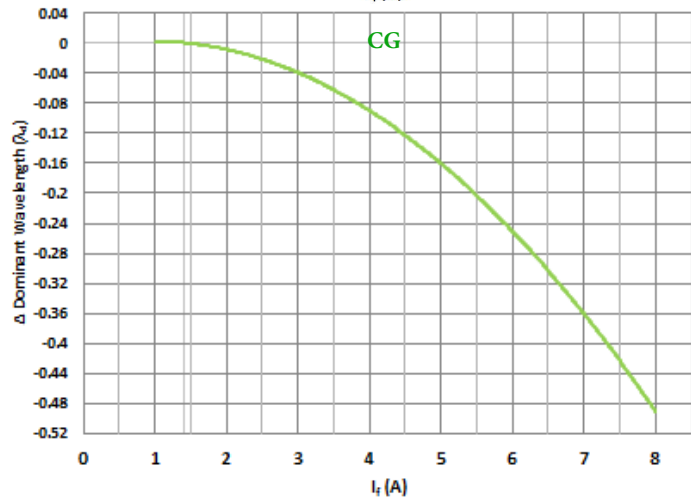
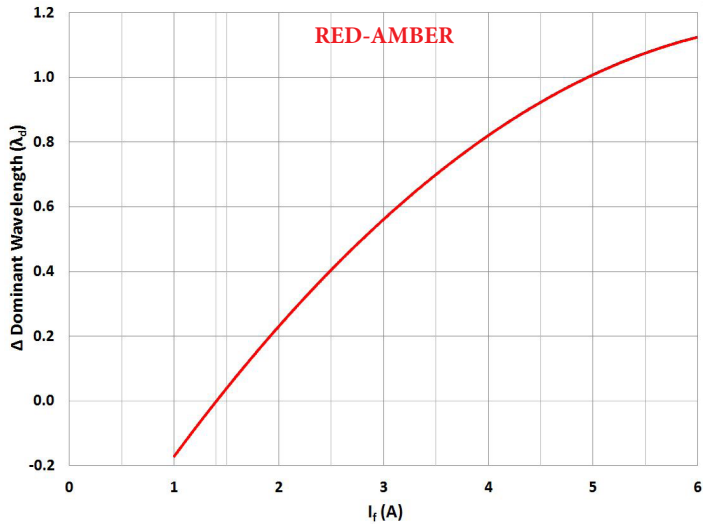

vs. T_j ($I_f = 1.4\text{A Pulse}$)

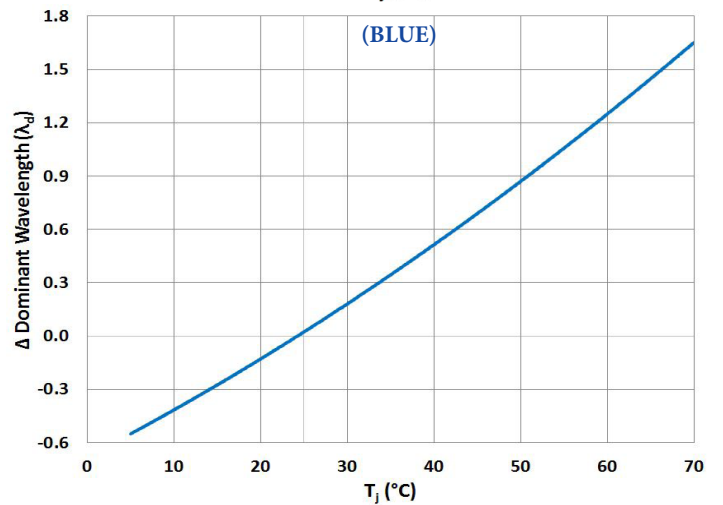
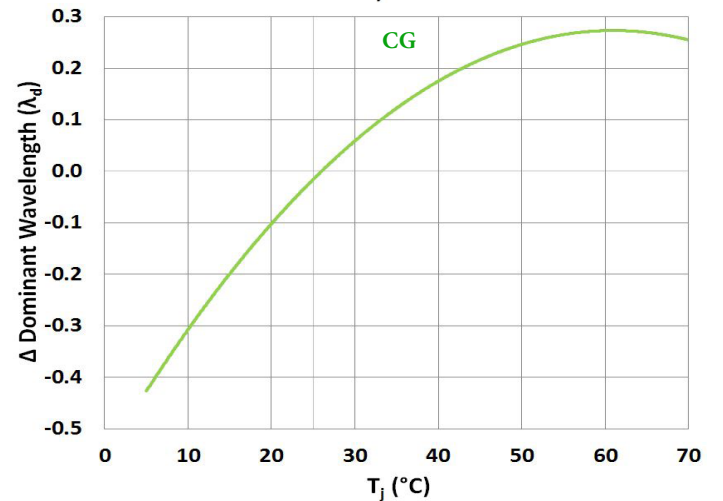
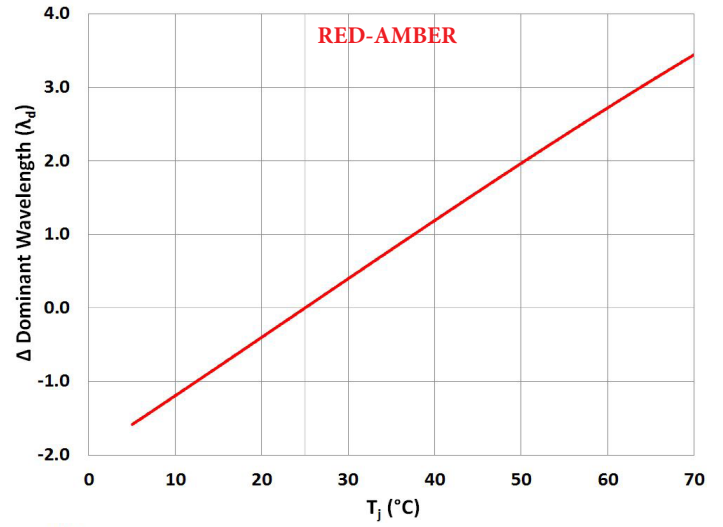

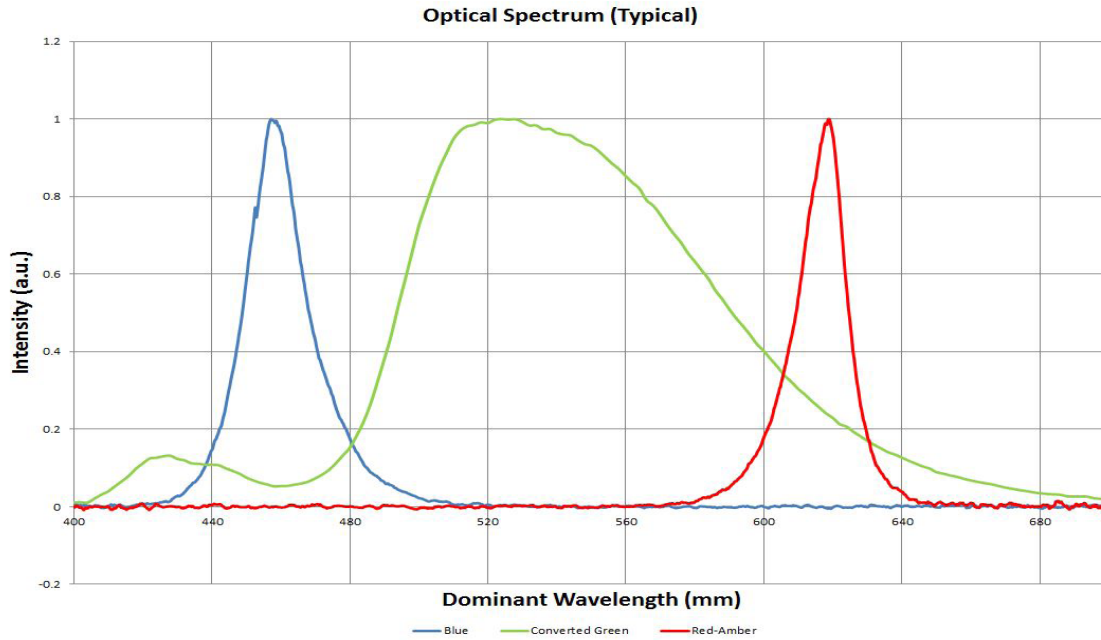
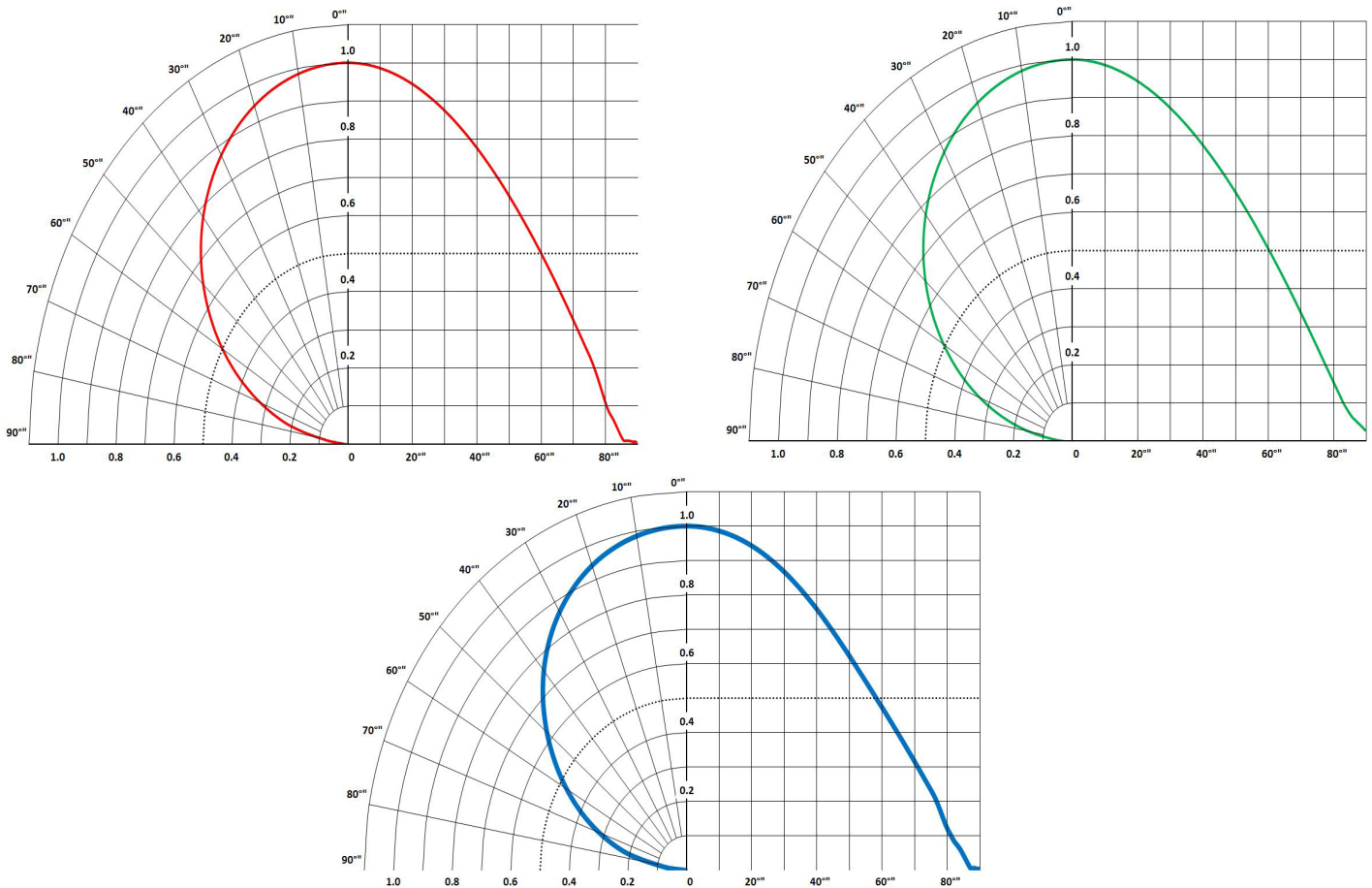
SFT-Series Optical Spectrum (Typical)¹

Angular Intensity Distribution (Typical)¹

Note 1: Data is recorded using standard test conditions and tolerances as described on page 6.

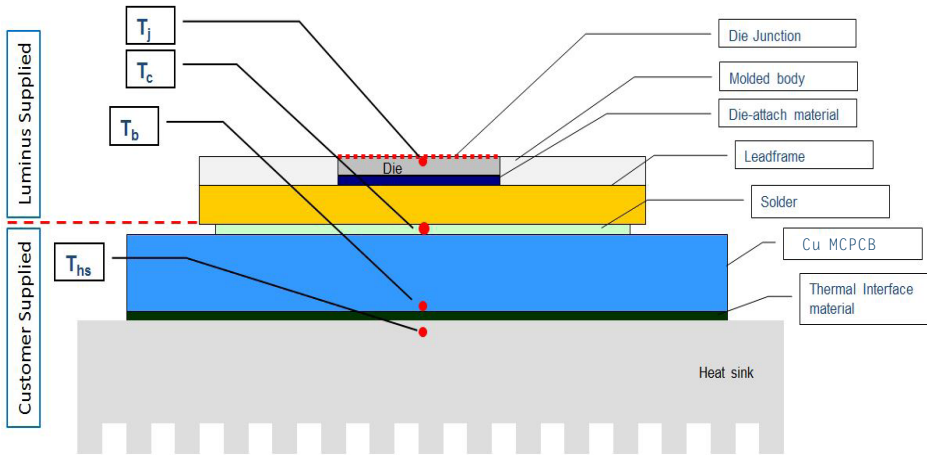
Thermal Resistance



Typical Thermal Resistance

$R_{th_{J-B}}^{1,2}$	1.7° C/W
$R_{th_{J-C}}^{1,2}$	1.0° C/W

See Note 3.

- Note 1: Thermal resistance values are based on FEA model results correlated to measured $R_{th_{J-HS}}$ data.
- Note 2: Final thermal characteristics will be dependent on overall customer system thermal design.
- Note 3: For optimal results, Luminus recommends customer PCB Design in accordance with suggested provided by the Luminus application note, "Design Guidelines for SFT Chipset Assembly".

Electrical Pinout / Solder Pad Layout

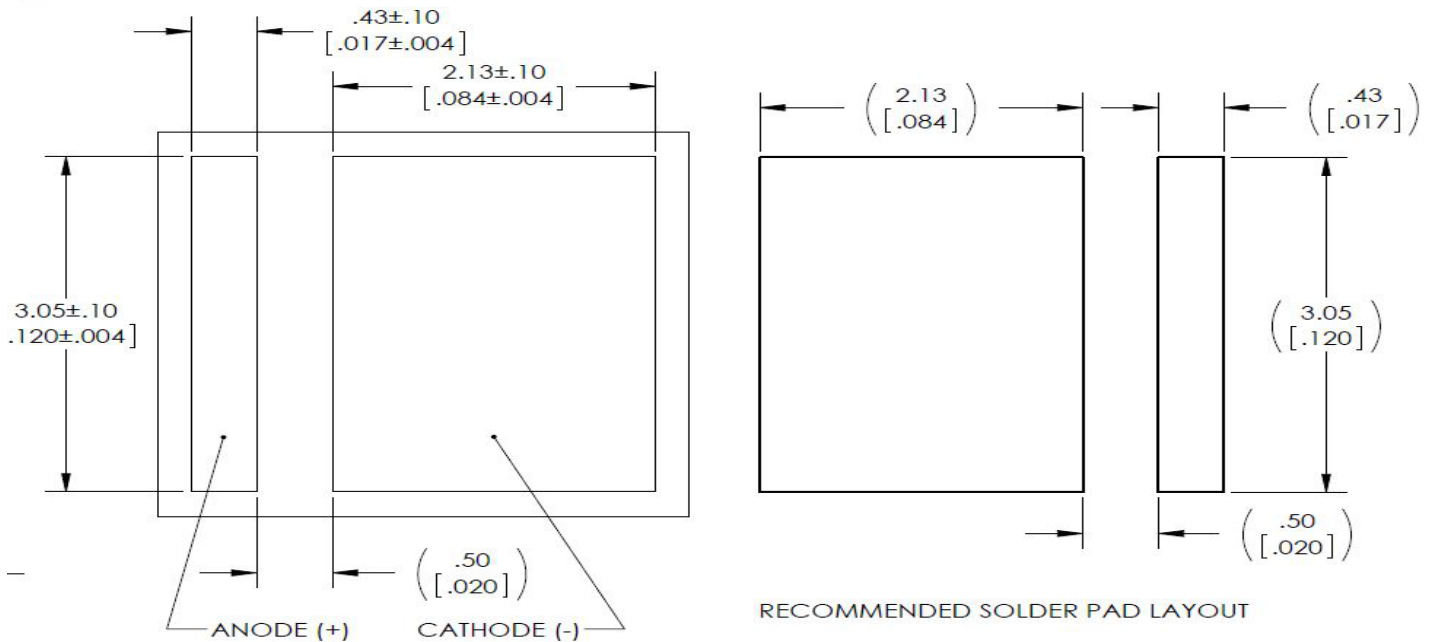

- Note: Layout is common to all colors.
For Detail recommended solder profiles, see page 16

Optimal LED performance is dependent on a proper system design. Please review the Luminus application note, "Design Guidelines for SFT Chipset Assembly". Contact Luminus for more detail.

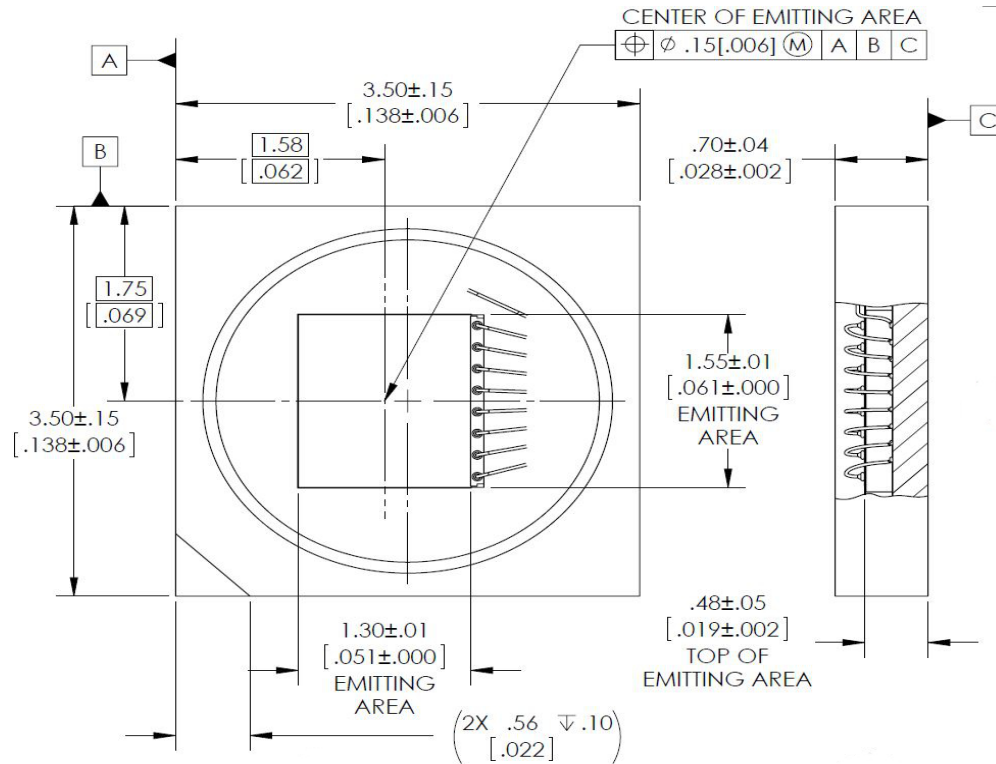
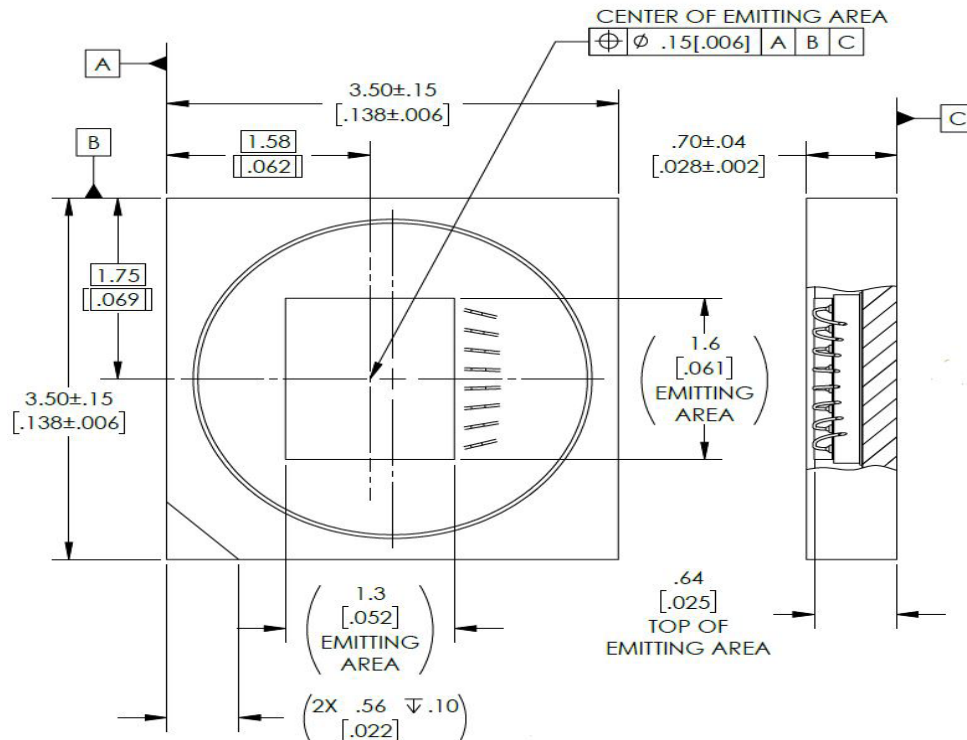
Mechanical Dimensions - SFT-20 [Red / Blue] in "F35" Package Configuration

Mechanical Dimensions - SFT-20 [Converted Green] in "F35" Package Configuration

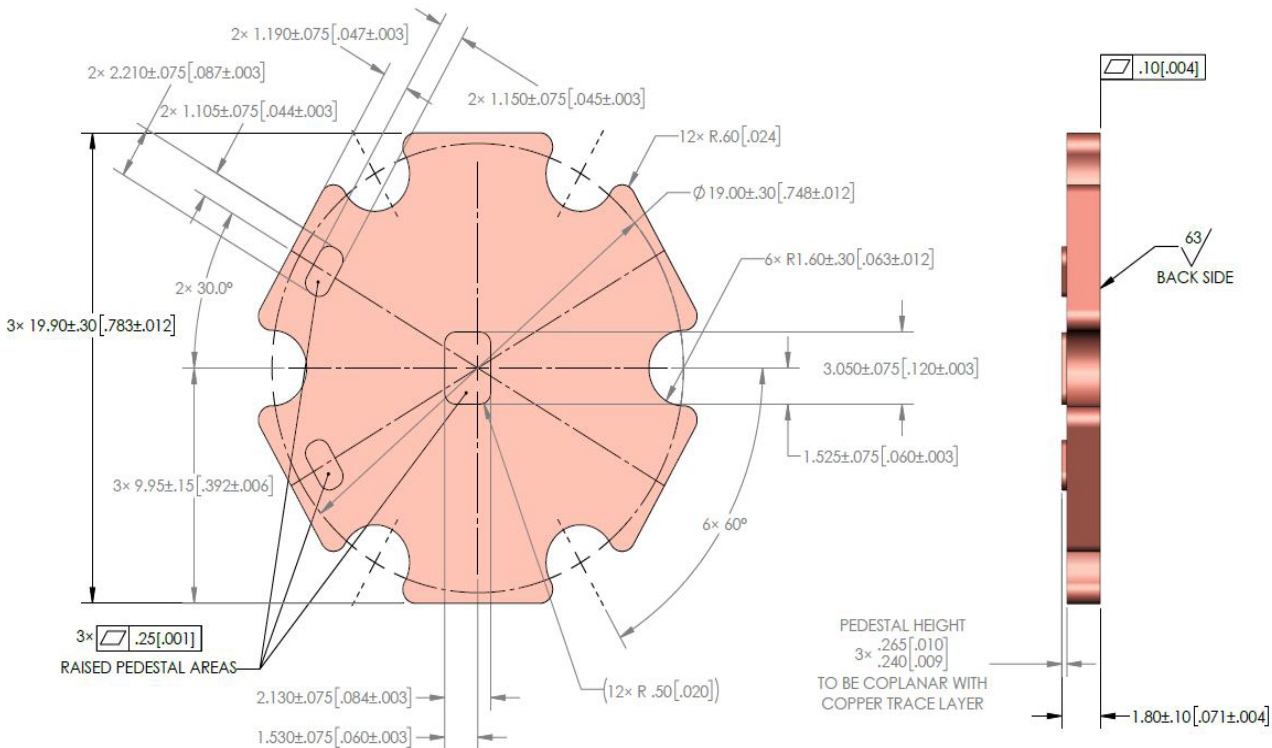
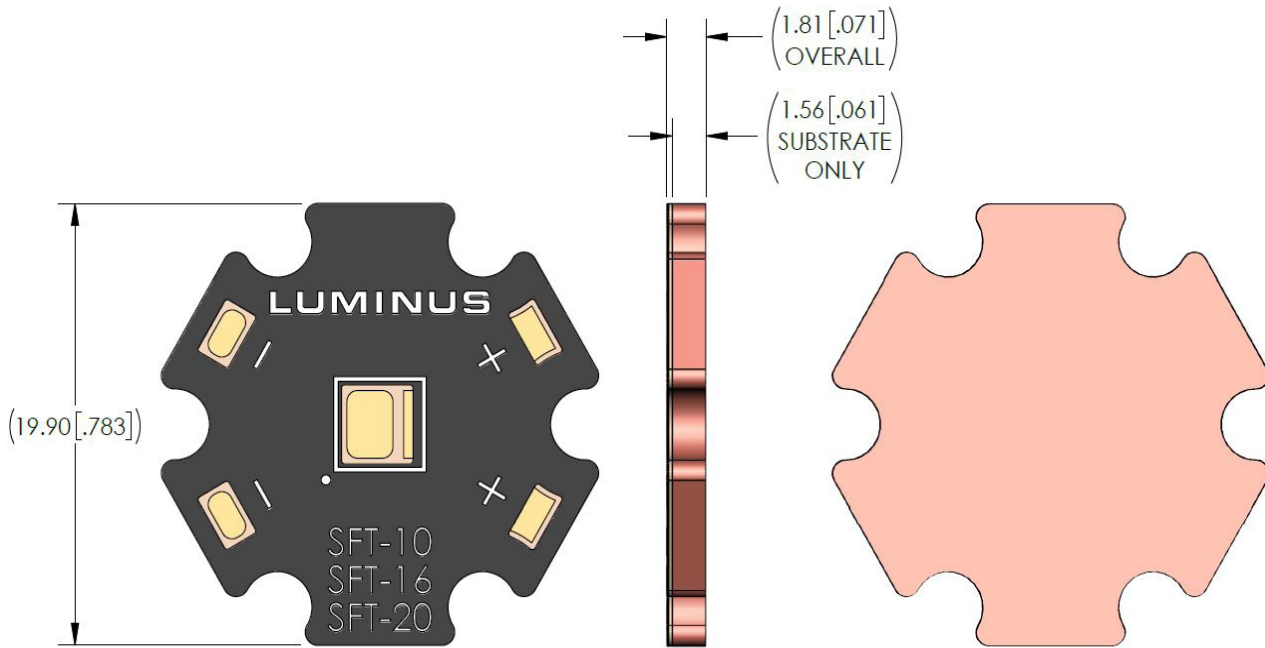
Notes: CONVERTED GREEN differs from RED/BLUE in only the emitting platelet is slightly larger and slightly higher than the underlying die.
 REFERTO DWG -002790/002792 for Full Dimensions.

Mechanical Dimensions - "Starboard" Package Configuration

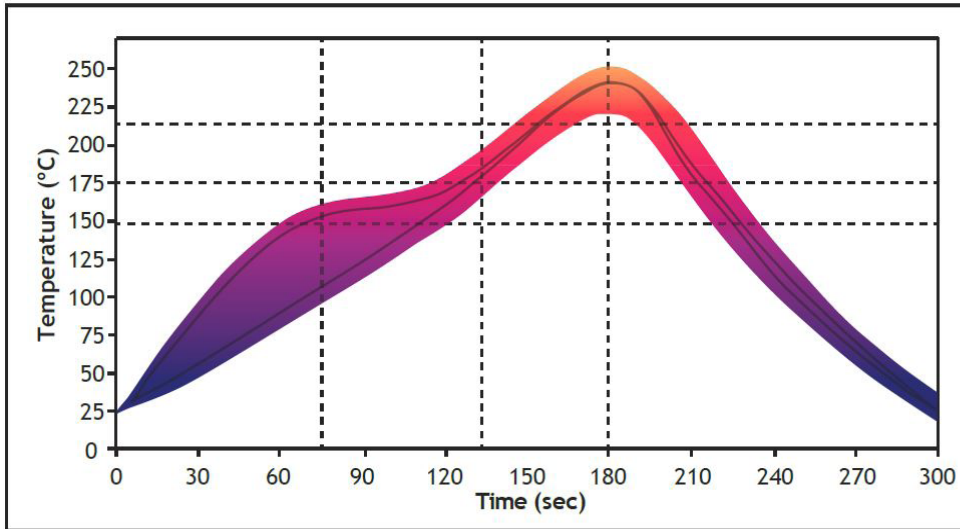
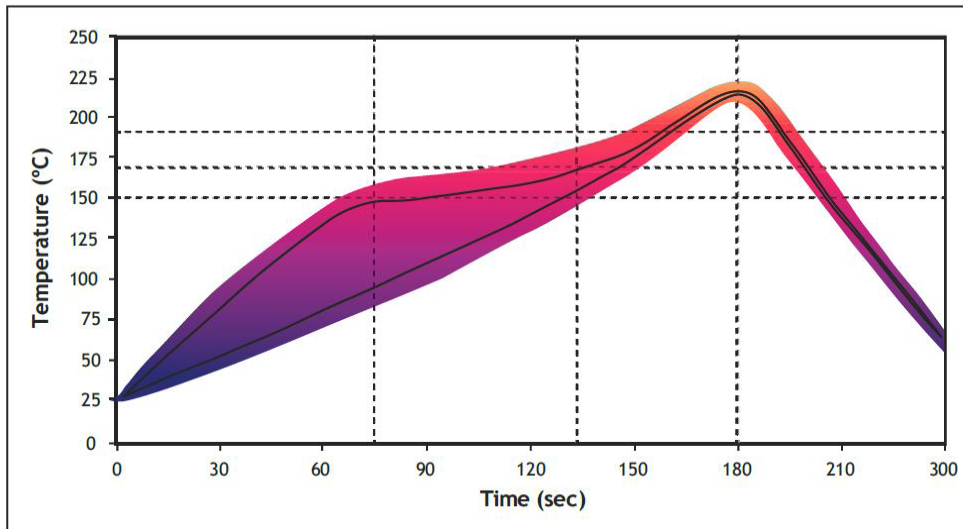
Notes:
 Dimensions shown are of bare Starboard. For full detail, please see DWG 400845 available from your local Luminus representative or web site.
 This Starboard is not electrically isolated. It is active and connected to the LED cathode.
 Starboard requires electrical isolation in most customer designs. Please see application note APN

SOLDER PROFILE INFORMATION

SAC305 Solder Profile Graph

Sn63 & Sn62 Solder Profile Graph

SAC 305 and Sn63 & Sn62 Solder Profile			
Feature	SAC 305	Sn63 & Sn62	Unit
Ramp Up Rate Ambient to Preheat (min)	1.15	1	Degrees Celsius Per Second (°C/s)
Preheat Temperature	175	150	Degrees Celsius (°C)
Profile Length (Preheat to Peak)	165-210	165-210	Seconds (s)
Ramp Up Rate Preheat to Peak (min)	1.5	0.84	Degrees Celsius Per Second (°C/s)
Liquid Temperature	217	183	Degrees Celsius (°C)
Peak Temperature	235	225	Degrees Celsius (°C)
Time Above Liquid Temperature	30-60	30-60	Seconds (s)
Time Within 5C of Peak	20	10	Seconds (s)
Cool down Rate	<4	<4	Degrees Celsius Per Second (°C/s)
Cool Down Duration	30-60	30-60	Seconds (s)
25 C to peak Temperature	180	180	Seconds (s)

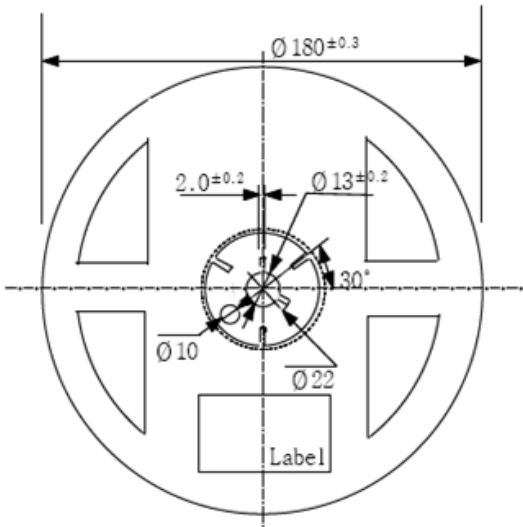
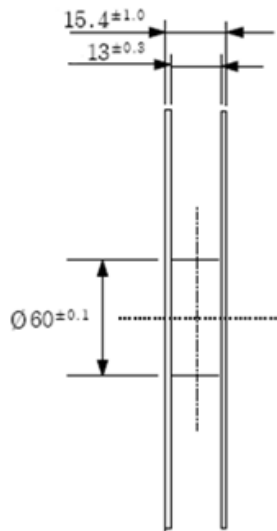
SHIPPING / PACKAGING INFORMATION

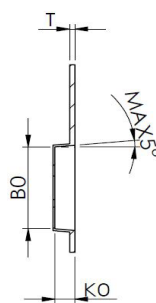
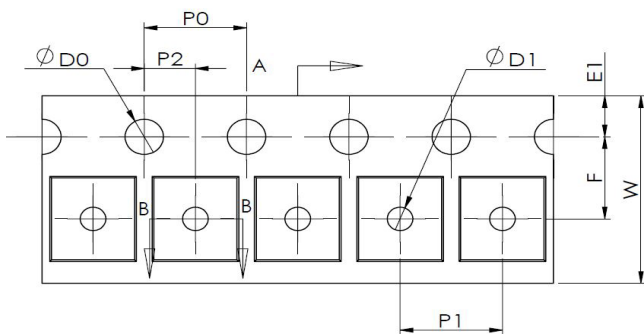
ITEM	REEL	Box	
		PACKING SPEC	BOX DIMENSION
PACKAGING	250 PCS / REEL	5 REELS PER BOX = 1250 PCS PER BOX	225 X 245 X 65MM

REEL DIAGRAM

TAPE DIMENSIONING DIAGRAM AND TABLE

BOX DIAGRAM

DIMENSION	SPEC (MM)
A0	3.80 +/- 0.10
B0	4.00 +/- 0.10
K0	1.20 +/- 0.10
P0	4.00 +/- 0.10
P1	8.00 +/- 0.10
P2	2.00 +/- 0.05
T	0.30 +/- 0.05
E1	1.75 +/- 0.10
F	5.50 +/- 0.05
D0	1.55 +/- 0.05
D1	1.55 +/- 0.05
W	12.00 +/- 0.01

REEL PACKAGING



Desiccant (bag)

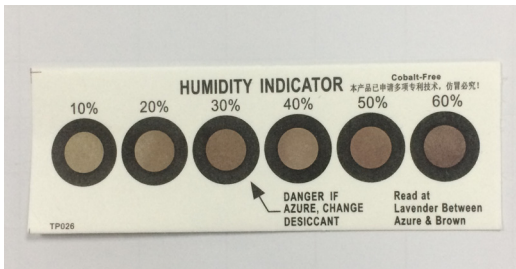
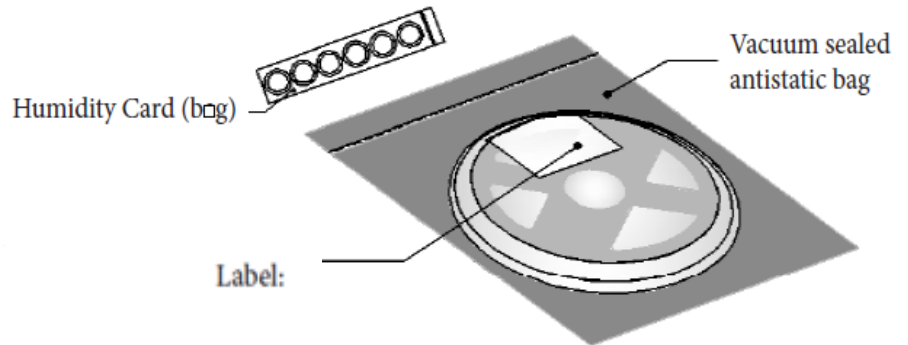

HUMIDITY CARD

THE HUMIDITY INDICATOR IS INCLUDED WITHIN EACH ANTI-STATIC BAG. IF HUMIDITY INDICATOR IS TRIGGERED REPLACE DESICCANT AND/OR PRE-BAKE PRIOR TO SYSTEM ASSEMBLY.

LDI RECOMMENDS ALL SFT-SERIES LED ARE STORED "SEALED" UNTIL TIME OF USE. SEE APPLICATION NOTE.



LABEL



CPN: SFT-20-B-F35

MPN: 113146

QTY: 250

BIN INFO		MFG INFO	
Flux:	4A	Rev:	01
Voltage:	V1	Lot#:	TOR-1607034
Color:	B	RoHS Compliant	

Label Fields:

- **CPN:** Customer orderable Part Number (as defined on P3)
- **MPN:** Manufacturer Part Number (Internal Luminus use)
- **QTY:** Quantity of Devices
- **Bin/Flux:** Flux Bin
- **Bin/Voltage:** Vf Bin (Internal Luminus use)
- **Bin/Color:** Color or Wavelength
- **MFG INFO:** Luminus Internal Use