

Safety Light Curtains

Type 2 SG2 Series (Basic & Extended Models)

Hand Protection



Presence Protection



- Integrated light curtain for Hand Protection or Presence Control
- Operating distance up to 19m
- Controlled heights from 150 to 1800mm
- Compact 32 x 37mm profile
- Sturdy profile and rotating brackets
- Test/Restart, Auto/Manual Restart, EDM, Anti-interference
- User interface with display
- Alignment function

The SG2 Type 2 series offers two models, the SG2 basic and the SG2 extended. Available functions include Test/Restart, EDM and Anti-interference. With very fast response times, the SG2 series can be installed right next to a hazardous area improving productivity. The rotating mounting brackets make installation and the alignment of the emitting and receiving units easy, even at long distances and in applications that use mirrors.

Type 4 SG4 Series

Finger Protection



Hand Protection



- Integrated light curtain for Finger Protection or Hand Protection
- Operating distance up to 6m for Finger Protection series & 19m for Hand Protection series
- Controlled heights from 150 to 1800mm
- Compact 32 x 37mm profile
- Sturdy profile and rotating brackets
- Test/Restart, Auto/Manual Restart, EDM
- User interface with display
- Alignment function

With mounting brackets that rotate, no connection necessary between emitter and receiver, and configuration that can be accomplished without external control units or supplementary cables, the SG4 Type 4 light curtains are one of the best available on the market today. In addition, the light curtains can be aligned using the 7 segment display on either the emitter or receiver.



Applications

The SG safety light curtain family provides solutions for automation where access to hazardous areas must be controlled. In particular, safety curtains can be used to stop machine movement in the following industries.

- Automated manufacturing

SG2 Series

Milling Machine



Situation: Protect operator hand's from injury from moving parts.

Solution: The machine's movement stops immediately even if only one of the safety light curtain beams is interrupted.

Machine Restart Prevention



Situation: Avoid accidental machine restart when an operator is performing maintenance.

Solution: A safety light curtain can stop a machine when the operator enters a hazardous area. A manual restart is then necessary to restart the production cycle. Horizontal light curtains are positioned and actually connected to the restart of the main light curtain in the areas where the operator may not be visible when doing maintenance.

Robotic Manufacturing

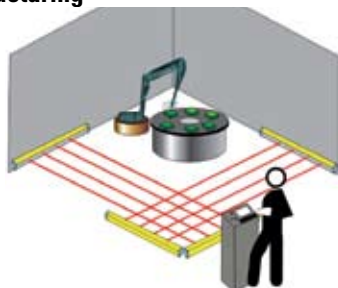

Situation: Protect operator from being hit or crushed by a robotic arm's movement.

Solution: The robot stops when the operator enters a hazardous area and interrupts the optic grid, usually placed on the floor.

SG4 Series

Operating Point Protection on a Drilling Machine



Situation: An operator positions a part before machining and removes it when done and must be protected from injury while working.

Solution: When the operator's hand interrupts the light beam, the SG4 series of safety light curtains stop the machine's movement because the light curtain can be installed directly on the machine near the hazard.

Paper Cutting Machines

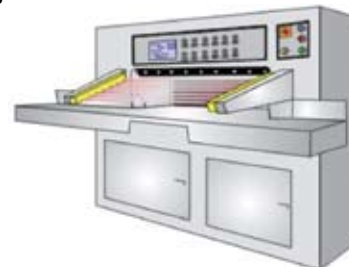

Situation: These machines typically cut paper to a specific size for newspapers or special applications and the operator needs to be protected against injury from the cutter blades.

Solution: Installed directly on the machine near the hazardous area, the SG4 series of safety light curtains stop the machine when the operator's hand interrupts the light beam.





Machine Press



Situation: Protect operator from either being pinned between the top and bottom portions of a machine press, or struck by the machined part while it is moving.

Solution: If even one beam of the SG4 series safety light curtain is interrupted by an operator's hand or finger, while the press is moving, the mobile tool bar will stop.

Specifications

	SG2 - Hand Series		SG2 - Presence Control Series		SG4 - Finger Series		SG4 - Hand Series		
	Type 2 Safety Category				Type 4 Safety Category				
									
Electrical	Power supply (Vdd)	24V DC ± 20%				24V DC ± 20%			
	Consumption (TX):	2.5W max				2.5W max			
	Consumption (RX):	3.5W max (without load)				4W max (without load)			
	OSSD outputs:	2 PNP (push-pull)				2 PNP (push-pull)			
	Short-circuit protection:	1.4A max				1.4A max			
	Output current:	0.5A max on each output				0.5A max on each output			
	Output voltage – ON status:	Vdd-1V min				Vdd-1 V			
	Output voltage – OFF status:	0.2V max				0.2V max			
	Leakage current:	< 1mA				< 1mA			
	Capacitive load:	2.2 uF @ 24V DC max*				2.2 uF @ 24V DC*			
	Controlled height:	150 - 1800mm		300 - 1800mm		150 - 1800mm			
	Auxiliary functions:	Test/Reset, Auto/Manual Restart (extended), EDM (extended)				Test/Reset, Auto/Manual Restart, EDM			
Electrical protection:	Class I / Class III				Class I / Class III				
Connections:	M12: Emitter 4 pole, Receiver 5 pole (basic), 8 pole (extended)				M12: Emitter 4-pole, Receiver 8-pole				
Cable length (for powering)	50m. max *				50m. max *				
Optical	Light emission:	Infrared LED (950nm)				Infrared LED (950nm)			
	Resolution:	30mm		50mm / 90mm		14mm		30 mm	
	Operating distance:	0.2m-19m (basic) or selectable 0.2m-9m / 0.2-19m (extended)				0.2 - 6m		0.2 - 19m	
	Aperture angle (EAA):	±5°				±2.5°			
	Ambient light rejection:	IEC 61496-2				IEC 61496-2			
Mechanical & Environmental	Operating temperature:	0 - 55°C				0 - 55°C			
	Storage temperature:	-25 to +70°C				-25 to +70°C			
	Temperature class:	T6				T6			
	Humidity:	15 - 95% (no condensation)				15 - 95% (no condensation)			
	Mechanical protection:	IP65 (EN 60529)				IP65 (EN 60529)			
	Vibrations:	0.35mm amplitude, 10 - 55 Hz frequency 20 sweep per axis, 1 octave/min (EN 60068-2-6)				0.35mm amplitude, 10 - 55 Hz frequency 20 sweep per axis, 1 octave/min (EN 60068-2-6)			
	Shock resistance:	16ms (10g) 1.000 shock per axis, (EN 60068-2-29)				16ms (10g) 1.000 shock per axis, (EN 60068-2-29)			
	Housing material:	Painted aluminium (yellow RAL 1003)				Painted aluminium (yellow RAL 1003)			
Protective shield material:	PMMA				PMMA				

*If a longer cable is needed, please verify that the capacitive load specifications are followed.

Control Heights

Height
150mm*
300mm
450mm
600mm
750mm
900mm
1050mm
1200mm
1350mm
1500mm
1650mm
1800mm

Number of Controlled Beams











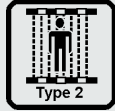

Height	SG2 Hand	SG2 Presence		SG4 Finger	SG4 Hand
		50mm	90mm		
150	8	–	–	16	8
300	16	9	5	32	16
450	24	13	7	48	24
600	32	17	9	64	32
750	40	21	11	80	40
900	48	25	13	96	48
1050	56	29	15	112	56
1200	64	33	17	128	64
1350	72	37	19	144	72
1500	80	41	21	160	80
1650	88	45	23	176	88
1800	96	49	25	192	96

* Not applicable to SG2 Presence Control series.

Response Time (ms)

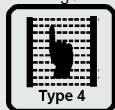
Height	SG2 Hand	SG2 Presence		SG4 Finger	SG4 Hand
		50mm	90mm		
150	8	–	–	11	9
300	9	9	9	15	11
450	11	10	10	18	13
600	12	11	11	22	14
750	14	12	12	25	16
900	15	14	13	29	18
1050	17	15	14	33	19
1200	18	16	15	36	21
1350	20	17	16	40	23
1500	21	18	17	43	25
1650	23	19	18	47	26
1800	24	20	19	50	28

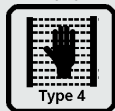
Part Numbers

Item	Safety Category	Protection Type	Resolution	Included Functions	Part Number
	Type 2	Hand  Type 2		Basic Model - Test/Reset	SG2-30-□-00-X
		Presence  Type 2		Extended Model - Test/Reset, Auto/Manual Restart, EDM	SG2-30-□-00-E-C
				Basic Model - Test/Reset	SG2-50-□-00-X
				Extended Model - Test/Reset, Auto/Manual Restart, EDM	SG2-50-□-00-E-C
				Basic Model - Test/Reset	SG2-90-□-00-X
			Extended Model - Test/Reset, Auto/Manual Restart, EDM	SG2-90-□-00-E-C	
	Type 4	Finger  Type 4		Test/Reset, Auto/Manual Restart, EDM	SG4-14-□-00-E
		Hand  Type 4		Test/Reset, Auto/Manual Restart, EDM	SG4-30-□-00-E





Controlled Height Code	
Controlled Height	Code
150mm*	015*
300mm	030
450mm	045
600mm	060
750mm	075
900mm	090
1050mm	105
1200mm	120
1350mm	135
1500mm	150
1650mm	165
1800mm	180

* Not applicable to SG2 Presence Control series.

In place of □ enter the Controlled Height code. See table on the right.

Accessories

M12 Unshielded Axial Connector Cable, UL 2464

Item	# of Poles	Used For	Cable Length	Part Number	
	4		SG4 & SG2 Emitters	3m	CS-A1-02-U-03
				5m	CS-A1-02-U-05
				10m	CS-A1-02-U-10
				15m	CS-A1-02-U-15
				25m	CS-A1-02-U-25
	5		SG2 Basic Model Receivers	3m	CS-A1-03-U-03
				5m	CS-A1-03-U-05
				10m	CS-A1-03-U-10
				15m	CS-A1-03-U-15
	8		SG4 & SG2 Extended Model Receivers	3m	CS-A1-06-U-03
				5m	CS-A1-06-U-05
				10m	CS-A1-06-U-10
15m				CS-A1-06-U-15	
25m	CS-A1-06-U-25				

Mounting Brackets

Item	Description	Part Number
	Angled mounting brackets (4 pc kit)	ST-KSTD
	Anti-vibration supports (4 pc kit)	ST-K4AV
	Anti-vibration supports (6 pc kit)	ST-K6AV
	Top-Bottom rotating mounting brackets (4 pc kit)	ST-K4ROT

Laser Pointer

Item	Description	Part Number
	Laser pointer used to aide in aligning safety light curtains.	SG-LP

Dimensions (mm)

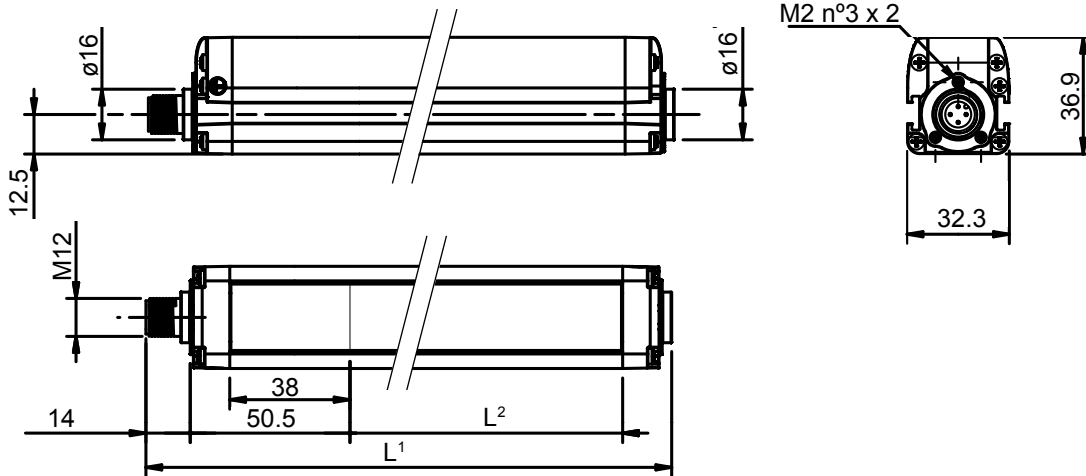

Dimension Table

Model	L ¹	L ²
150*	233.3	153.3
300	383.2	303.2
450	533.2	453.3
600	683.2	603.2
750	833.2	753.3
900	983.2	903.2
1050	1133.2	1053.2
1200	1283.3	1203.3
1350	1433.2	1353.2
1500	1583.3	1503.3
1650	1733.3	1653.3
1800	1883.3	1803.3

* Not applicable to SG2 Presence Control series.

Connections

SG2 Basic Models

M12 5-Pole Connector

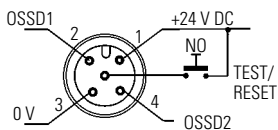

Pin	Cable Color	Function
1	brown	+24V DC
2	white	OSSD1
3	blue	0V
4	black	OSSD2
5	gray	TEST/RESET

M12 4-Pole Connector

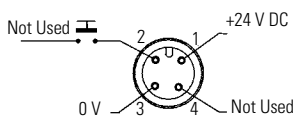

Pin	Cable Color	Function
1	brown	+24V DC
2	white	Not Used
3	blue	0V
4	black	Not Used

SG2 Extended Models / SG4 Models

M12 8-Pole Connector

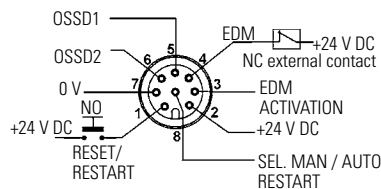

Pin	Cable Color	Function
1	white	RESET*
2	brown	+24 V DC
3	green	EDM Activation
4	yellow	EDM
5	gray	OSSD1
6	pink	OSSD2
7	blue	0 V
8	red	SEL MAN / AUTO RESTART

*Automatic RESTART - RESET function
Manual RESTART - RESET/RESTART function

M12 4-Pole Connector

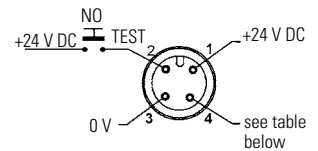

Pin	Cable Color	Function
1	brown	+24V DC
2	white	TEST
3	blue	0 V
4	black	SG2: SEL operating distance SG4: Not Used

Indicators & Settings

SG4 and SG2 light curtains are equipped with an Alignment system that shows alignment status on a visual display, making configuration quick and easy. Alignment level and any change in environment conditions (presence of dust, light disturbance, etc.) are monitored during normal operating mode. The display also gives diagnostic messages to ensure accurate and correct functioning.

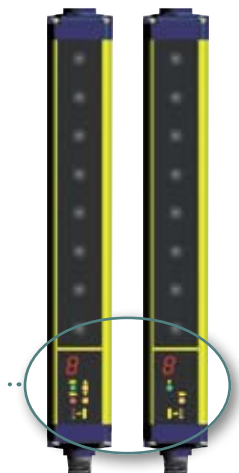
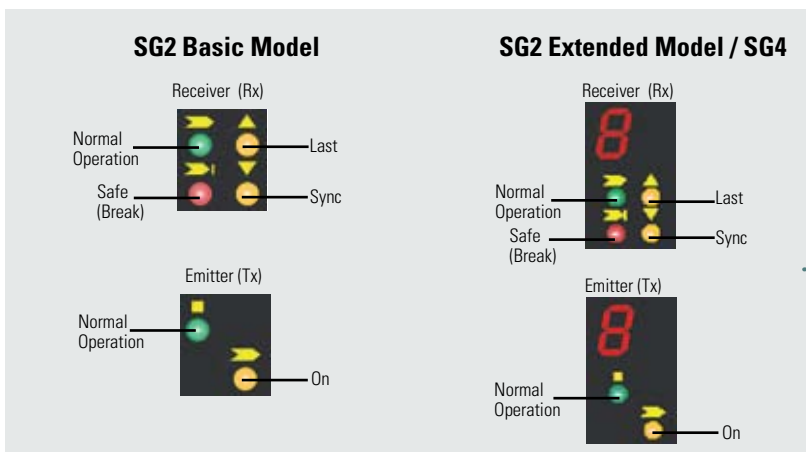

Mounting Brackets Dimensions (mm)

Rotating Mounting Bracket ¹ (ST-K4ROT)

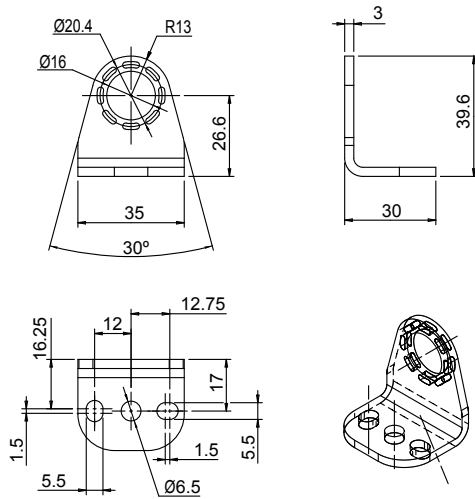

1. Supplied with the SG2 extended models only.

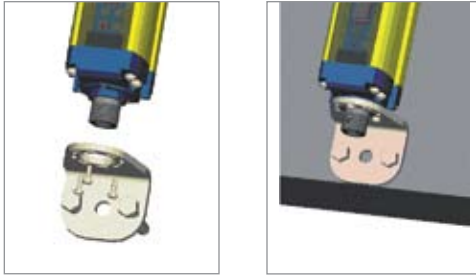

Angled Mounting Bracket ² (ST-KSTD)

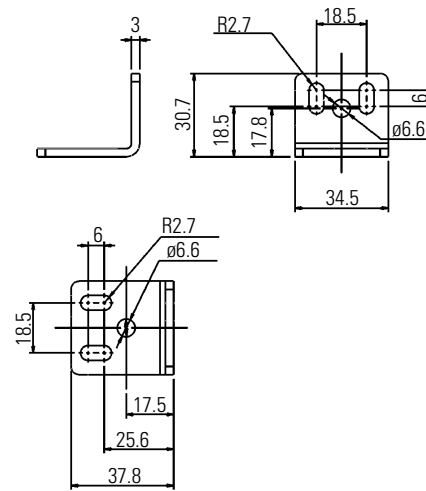

2. Supplied with SG2 standard models and all SG4 models.

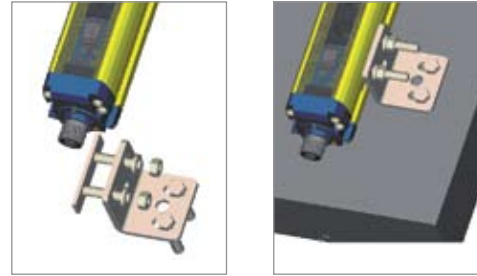

Anti-vibration Support Brackets (ST-K4AV/ST-K6AV)



Mounting Bracket with Light Curtain (mm)

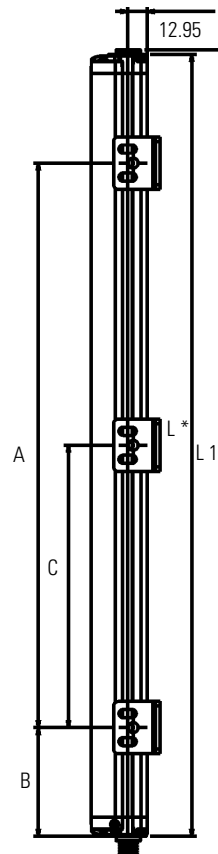

Mounting Bracket Dimension Table (mm)

Height	L	A	B	C
150*	216.3	108	54	-
300	366.2	216	75	-
450	516.3	316	100	-
600	666.2	366	150	-
750	816.3	466	175	-
900	966.2	566	200	-
1050	1116.2	666	225	-
1200	1266.3	966	150	483
1350	1416.2	1066	175	533
1500	1566.3	1166	200	583
1650	1716.3	1266	225	633
1800	1866.3	1366	250	683

* Not applicable to SG2 Presence Control series.