

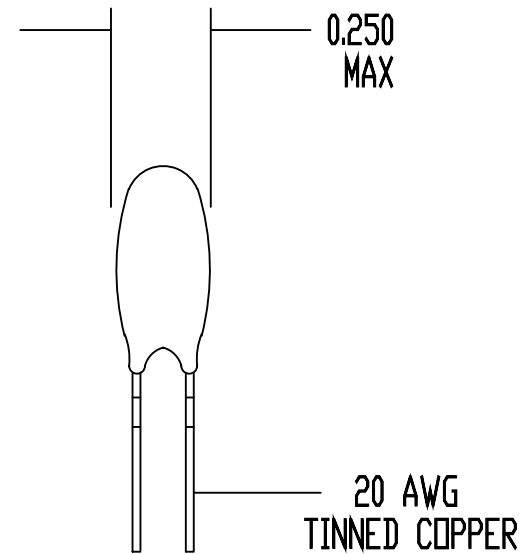

REV	DATE	ECD#
A	03/31/95	1342

DRAWING NOT TO SCALE
ALL DIMENSIONS IN INCHES

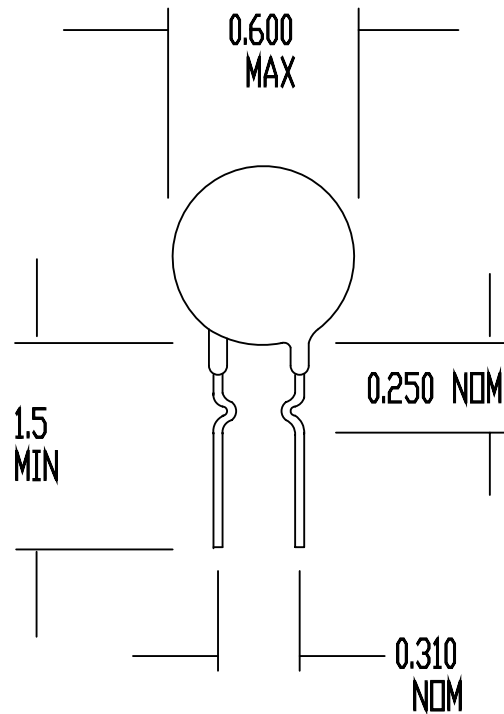

SPECIFICATIONS:

RESISTANCE AT 25 DEG C = 2.5 OHMS +/- 15%
 MAX CONTINUOUS CURRENT (I_{max}) = 9 AMPS
 RESISTANCE AT I_{max} = 0.04 OHMS NOMINAL
 MAX VOLTAGE RATING = 265 VAC (RMS)
 MAX SURGE RATING = 27 JOULES
 ENCAPSULATION = SILICONE RESIN
 MARKING = OPTIONAL
 LEADS = RODAN P/N STL-209-42

DRAWN BY D. NGUYEN		 Circuit Protection Thermistors
DATE 09/25/90	ORIG. F. TISED	
REV A	APP	SURGE-GARD INRUSH CURRENT LIMITER
SHEET 1 OF 1		SG305