

Datasheet SHT3x-ARP

Humidity and Temperature Sensor IC

- Fully calibrated, linearized, and temperature compensated analog output
- Wide supply voltage range, from 2.4 V to 5.5 V
- 10% to 90% ratiometric analog voltage output
- Typical accuracy of $\pm 2\%RH$ and $\pm 0.3^{\circ}C$
- Parallel measurement of temperature and humidity at separate pins
- Tiny 8-Pin DFN package



Product Summary

SHT3x-ARP is the next generation of Sensirion's temperature and humidity sensors. It builds on a new CMOSens® sensor chip that is at the heart of Sensirion's new humidity and temperature platform. The SHT3x-ARP has increased intelligence, reliability and improved accuracy specifications. Its functionality includes enhanced signal processing, temperature and humidity

can be read out at different pins. The DFN package has a footprint of 2.5 x 2.5 mm² while keeping a height of 0.9 mm. This allows for integration of the SHT3x-ARP into a great variety of applications. Additionally, the wide supply voltage range of 2.4 V to 5.5 V guarantees compatibility with diverse assembly situations. All in all, the SHT3x-ARP incorporates 15 years of knowledge of Sensirion, the leader in the humidity sensor industry.

Benefits of Sensirion's CMOSens® Technology

- High reliability and long-term stability
- Industry-proven technology with a track record of more than 15 years
- Designed for mass production
- High process capability
- High signal-to-noise ratio

Content

| | | |
|---|----------------------------------|----|
| 1 | Sensor Performance..... | 2 |
| 2 | Specifications | 5 |
| 3 | Pin Assignment | 7 |
| 4 | Operation and Communication..... | 8 |
| 5 | Packaging..... | 10 |
| 6 | Shipping Package | 12 |
| 7 | Quality | 12 |
| 8 | Ordering Information..... | 13 |
| 9 | Further Information..... | 13 |

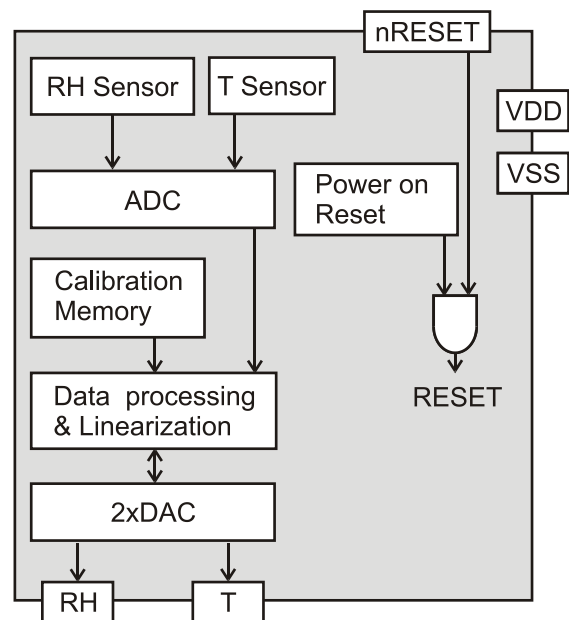

Figure 1 Functional block diagram of the SHT3x-ARP. The sensor signals for humidity and temperature are factory calibrated, linearized and compensated for temperature and supply voltage dependencies.

1 Sensor Performance

Humidity Sensor Specification

| Parameter | Conditions | Value | Units |
|---------------------------------------|------------------------|-----------------|--------|
| SHT30 Accuracy tolerance ¹ | Typ. | ±3 | %RH |
| | Max. | Figure 2 | - |
| SHT31 Accuracy tolerance ¹ | Typ. | ±2 | %RH |
| | Max. | Figure 3 | - |
| Repeatability ² | | 0.1 | %RH |
| Resolution | Typ. | 0.01 | %RH |
| Integrated Non-Linearity ³ | Typ. | 0.2 | %RH |
| Hysteresis | at 25°C | ±0.8 | %RH |
| Specified range ⁴ | extended ⁵ | 0 to 100 | %RH |
| Response time ⁶ | $\tau_{63\%}$ | 8 | s |
| Long-term drift | Typ. ⁷ | <0.25 | %RH/yr |
| Sensitivity | V _{DD} =2.4 V | 19.2 | mV/%RH |
| | V _{DD} =3.3V | 26.4 | mV/%RH |
| | V _{DD} =5.0V | 40.0 | mV/%RH |
| | V _{DD} =5.5V | 44.0 | mV/%RH |

Table 1 Humidity sensor specification

Temperature Sensor Specification

| Parameter | Condition | Value | Units |
|---------------------------------------|------------------------|------------|-------|
| SHT30 Accuracy tolerance ¹ | Typ., 0°C to 65°C | ±0.3 | °C |
| SHT31 Accuracy tolerance ¹ | Typ., 0°C to 90°C | ±0.3 | °C |
| Repeatability ² | | 0.06 | °C |
| Resolution | Typ. | 0.01 | °C |
| Specified Range | - | -40 to 125 | °C |
| Response time ⁸ | $\tau_{63\%}$ | >2 | s |
| Long Term Drift | Max. | <0.03 | °C/yr |
| Sensitivity | V _{DD} =2.4 V | 11.0 | mV/°C |
| | V _{DD} =3.3V | 15.1 | mV/°C |
| | V _{DD} =5.0V | 22.9 | mV/°C |
| | V _{DD} =5.5V | 25.1 | mV/°C |

Table 2 Temperature sensor specification

¹ For definition of typical and maximum accuracy tolerance, please refer to the document "Sensirion Humidity Sensor Specification Statement".

² The stated repeatability is 3 times the standard deviation (3σ) of multiple consecutive measurements at constant ambient conditions. It is a measure for the noise on the physical sensor output. It is measured with analog circuit and integrated over 1 second.

³ Maximum deviation from the ideal shape (linear curve)

⁴ Specified range refers to the range for which the humidity or temperature sensor specification is guaranteed.

⁵ For details about recommended humidity and temperature operating range, please refer to section 1.1.

⁶ Time for achieving 63% of a humidity step function, valid at 25°C and 1m/s airflow. Humidity response time in the application depends on the design-in of the sensor.

⁷ Typical value for operation in normal RH/T operating range, see section 1.1. Maximum value is < 0.5 %RH/yr. Value may be higher in environments with vaporized solvents, out-gassing tapes, adhesives, packaging materials, etc. For more details please refer to Handling Instructions.

⁸ Temperature response times strongly depends on the design-in of the sensor in the final application. Minimal response time can be achieved when the thermalized sensor at T1 is placed on a well conducting surface with temperature T2.

Humidity Sensor Performance Graphs

SHT30

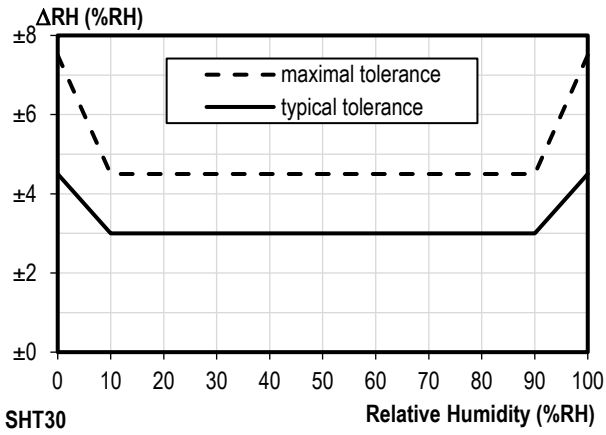

Figure 2 Tolerance of RH at 25°C for SHT30

SHT31

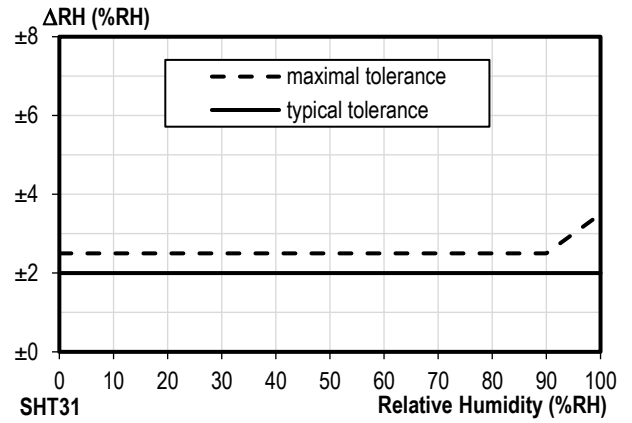

Figure 3 Tolerance of RH at 25°C for SHT31

SHT30

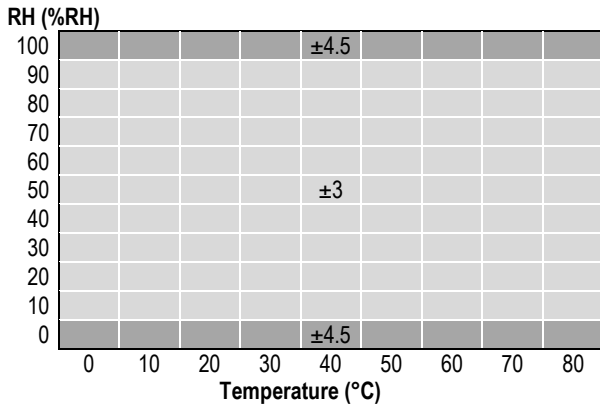

Figure 4 Typical tolerance of RH over T for SHT30

SHT31

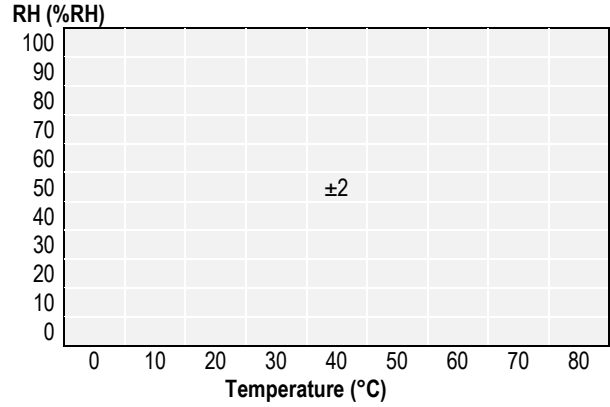

Figure 5 Typical tolerance of RH over T for SHT31

Temperature Sensor Performance Graphs

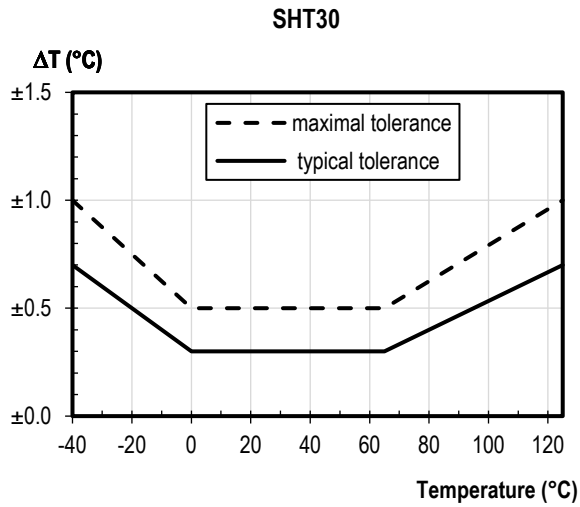

Figure 6 Temperature accuracy of the SHT30 sensor at VDD = 4.5V...5.5V.

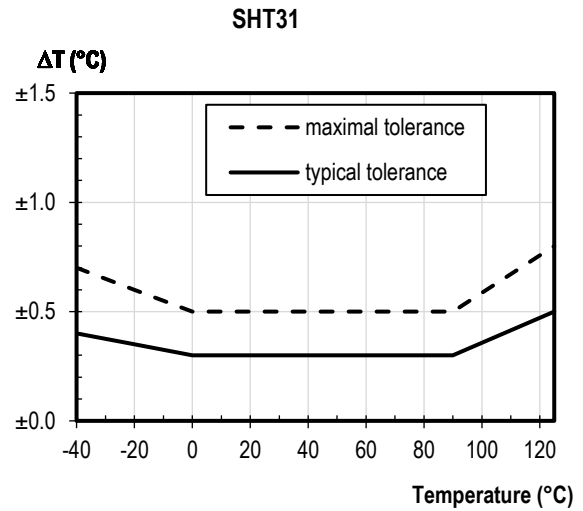

Figure 7 Temperature accuracy of the SHT31 sensor at VDD = 4.5V...5.5V.

1.1 Recommended Operating Condition

The sensor shows best performance when operated within recommended normal temperature and humidity range of 5 – 60 °C and 20 – 80 %RH, respectively. Long term exposure to conditions outside normal range, especially at high humidity, may temporarily offset the RH signal (e.g. +3%RH after 60h at >80%RH). After returning into the normal temperature and humidity range the sensor will slowly come back to calibration state by itself. Prolonged exposure to extreme conditions may accelerate ageing. To ensure stable operation of the humidity sensor, the conditions described in the document “SHTxx_STSxx Assembly of SMD Packages”, section “Storage and Handling Instructions” regarding exposure to volatile organic compounds have to be met. Please note as well that this does apply not only to transportation and manufacturing, but also to operation of the SHT3x-ARP.

2 Specifications

2.1 Electrical Specifications

| Parameter | Symbol | Condition | Min | Typ. | Max | Units | Comments |
|--|---------------|--------------------|-----|-------|-----|------------|--|
| Supply voltage | V_{DD} | | 2.4 | 3.3 | 5.5 | V | |
| Power-up/down level | V_{POR} | | 1.8 | 2.3 | 2.4 | V | |
| Slew rate change of the supply voltage | $V_{DD,slew}$ | | - | - | 20 | V/ms | Voltage changes on the VDD line between $V_{DD,min}$ and $V_{DD,max}$ should be slower than the maximum slew rate; faster slew rates may lead to reset |
| Supply current | I_{DD} | Average at T=25°C | - | 220 | 300 | μA | At resistive load 1M Ω |
| | | Average at T=125°C | - | 270 | - | μA | |
| Resistive load to VSS | R_L | | 50 | >1000 | - | k Ω | |
| Capacitive load | C_L | | 1 | 3.9 | 5 | nF | Capacitance that can be driven by the sensor on the signal lines. The typical value is recommended for improved EMC robustness. |

Table 3 Electrical specifications, typical values are valid for T=25°C, min. & max. values for T=-40°C ... 125°C.

2.2 Timing Specification for the Sensor System

| Parameter | Symbol | Conditions | Min. | Typ. | Max. | Units | Comments |
|-----------------------------|---------------|---|------|------|------|-------|--|
| Power-up time | t_{PU} | After hard reset, $V_{DD} \geq V_{POR}$ | - | - | 17 | ms | Time between V_{DD} reaching V_{POR} and first measurement signal available |
| Analog output settling time | AO_{settle} | For a step of $V_{DD}/2$ | - | 0.3 | | ms | Time needed for adapting to a changing supply voltage and measurement value. Value depends on output load. Typical value is for a load of 1nF. |
| Duration of reset pulse | t_{RESETN} | | 1 | - | - | us | See section 3.3 |

Table 4 System Timing Specification, valid from -40 °C to 125 °C and 2.4 V to 5.5 V.

2.3 Absolute Minimum and Maximum Ratings

Stress levels beyond those listed in Table 5 may cause permanent damage to the device or affect the reliability of the sensor. These are stress ratings only and functional operation of the device at these conditions is not guaranteed. Ratings are only tested each at a time.

| Parameter | Rating | Units |
|--|----------------------|--------------------|
| Supply voltage V_{DD} | -0.3 to 6 | V |
| Max Voltage on pins (pin 1 (RH); pin 2 (R); pin 3 (R); pin 4(T); pin 6 (nRESET)) | -0.3 to $V_{DD}+0.3$ | V |
| Input current on any pin | ± 100 | mA |
| Operating temperature range | -40 to 125 | $^{\circ}\text{C}$ |
| Storage temperature range | -40 to 150 | $^{\circ}\text{C}$ |
| ESD HBM (human body model) ⁹ | 4 | kV |
| ESD CDM (charge device model) ¹⁰ | 750 | V |

Table 5 Minimum and maximum ratings; values may only be applied for short time periods.

⁹ According to ANSI/ESDA/JEDEC JS-001-2014; AEC-Q100-002

¹⁰ According to ANSI/ESD S5.3.1-2009; AEC-Q100-011.

3 Pin Assignment

The SHT3x-ARP comes in a tiny 8-pin DFN package – see Table 6.

| Pin | Name | Comments |
|-----|--------|--|
| 1 | RH | Analog voltage out; output |
| 2 | R | No electrical function; recommended to connect to VSS |
| 3 | R | No electrical function; recommended to connect to VSS |
| 4 | T | Analog voltage out; output |
| 5 | VDD | Supply voltage; input |
| 6 | nRESET | Reset pin active low; input; if not used it is recommended to be left floating; can be connected to VDD with a series resistor of $R \geq 2 \text{ k}\Omega$ |
| 7 | R | No electrical function; to be connected to VSS |
| 8 | VSS | Ground |

Table 6 SHT3x-ARP pin assignment (transparent top view). Dashed lines are only visible if viewed from below. The die pad is internally connected to VSS.

3.1 Power Pins (VDD, VSS)

The electrical specifications of the SHT3x-ARP are shown in Table 3. The power supply pins must be decoupled with a 100 nF capacitor that shall be placed as close to the sensor as possible – see Figure 8 for a typical application circuit.

3.2 Temperature and Humidity Pin

The physical output of temperature and humidity can be read out at separated pins, as shown in Table 6. Data is supplied as ratiometric voltage output. The specification of the analog voltage signal and its conversion to physical values is explained in Section 4.

3.3 nRESET Pin

The nReset pin may be used to generate a reset of the sensor. A minimum pulse duration of 1 μs is required to reliably trigger a reset of the sensor. If not used it is recommended to leave the pin floating or to connect it to VDD with a series resistor of $R \geq 2 \text{ k}\Omega$. In addition, the nRESET pin is internally connected to VDD with a pull up resistor of $R = 50 \text{ k}\Omega$ (typ.).

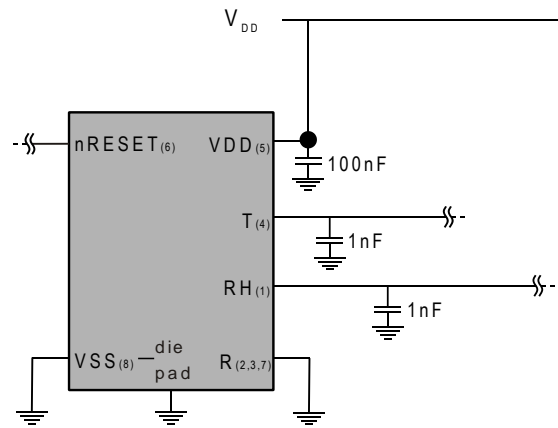

Figure 8 Typical application circuit. Please note that the positioning of the pins does not reflect the position on the real sensor. This is shown in Table 6.

3.4 Die Pad (center pad)

The die pad or center pad is visible from below and located in the center of the package. It is electrically connected to VSS. Hence electrical considerations do not impose constraints on the wiring of the die pad. However, due to mechanical reasons it is recommended to solder the center pad to the PCB. For more information on design-in, please refer to the document “SHTxx_STSxx Design Guide”.

4 Operation and Communication

4.1 Start-up of the sensor

The sensor starts up after reaching the power-up threshold voltage V_{POR} specified in Table 3. After reaching this threshold voltage the sensor needs the time t_{PU} until the first measurement signal is available as voltage output on the respective output pins. During that time the temperature and humidity pins have an undefined state.

4.2 Conversion of the Signal Output

The physical values as measured by the sensor are mapped to a ratiometric voltage output (V_T , V_{RH} as 10 to 90% of V_{DD}). Prior to conversion into a voltage signal, the physical values are linearized and compensated for temperature and supply voltage effects by the sensor. Additionally, the voltage output is calibrated for each sensor. Hence the relationship between temperature and humidity and the voltage output is the same for each sensor, within the limits given by the accuracy (Table 1 and Table 2).

This allows to describe the relationship between physical values (RH and T) and the voltage output for temperature and humidity (V_T , V_{RH}) through a generic linear formula given by equations (1), (2) and (3); its graphical representation can be found in Figure 9 & Figure 10.

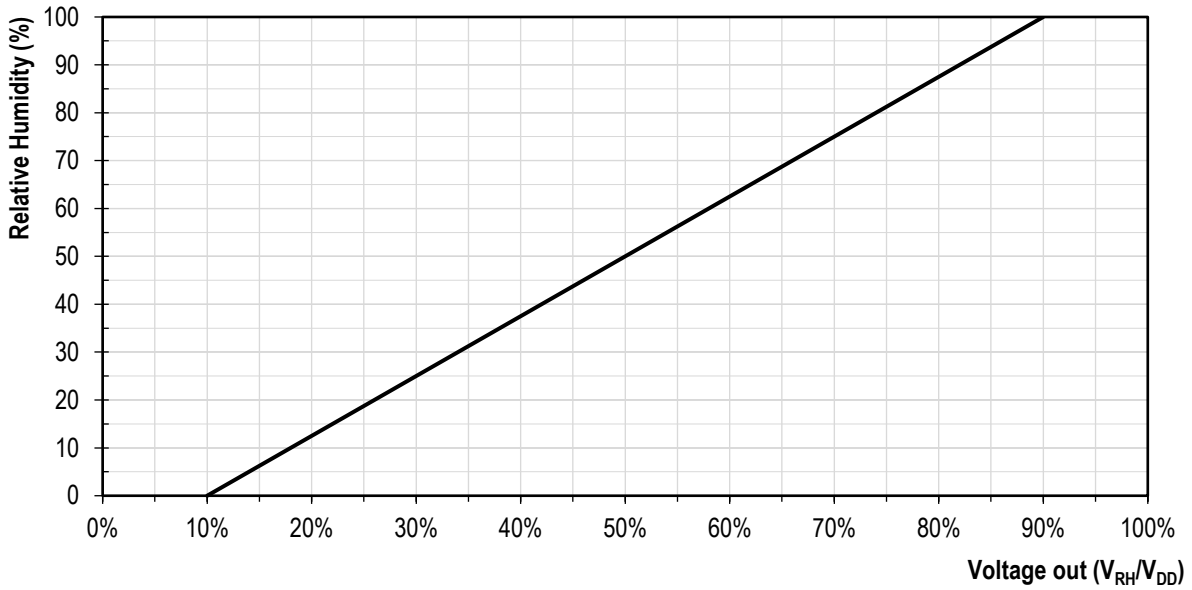

Figure 9 Relationship between the ratiometric analog voltage output and the measured relative humidity.

$$RH = -12.5 + 125 \cdot \frac{V_{RH}}{V_{DD}} = -\frac{10}{0.8} + \frac{100}{0.8} \cdot \frac{V_{RH}}{V_{DD}} \quad (1)$$

Equation (1) describes the conversion formula for the RH signal.

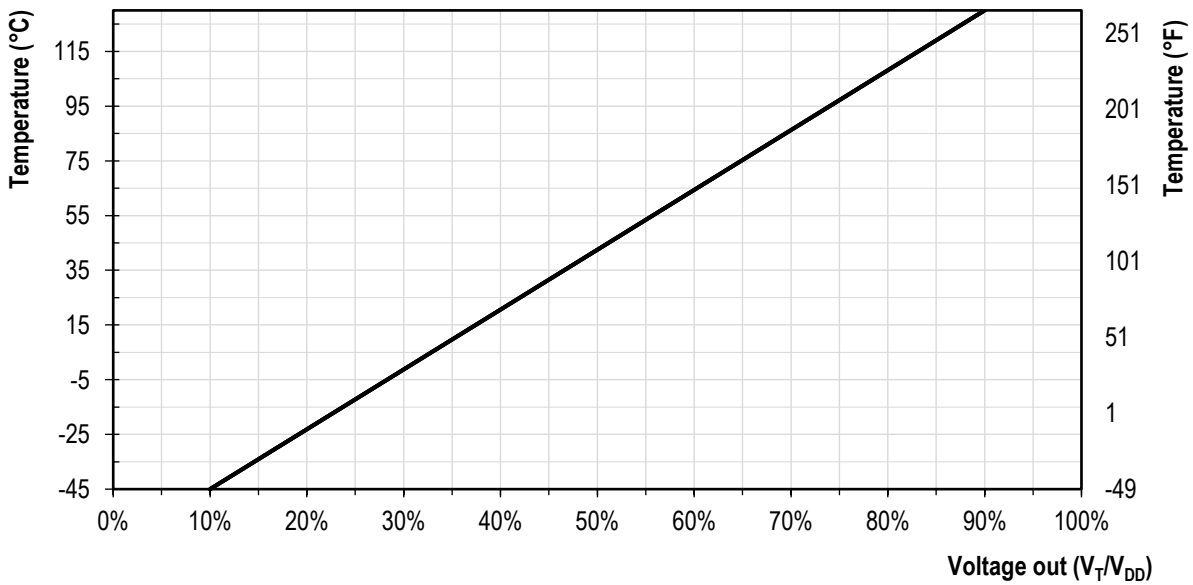

Figure 10 Relationship between the ratiometric analog voltage output and the measured temperature

$$T [^{\circ}C] = -66.875 + 218.75 \cdot \frac{V_T}{V_{DD}} = -45 - \frac{17.5}{0.8} + \frac{175}{0.8} \cdot \frac{V_T}{V_{DD}} \quad (2)$$

$$T [^{\circ}F] = -88.375 + 393.75 \cdot \frac{V_T}{V_{DD}} = -49 - \frac{31.5}{0.8} + \frac{315}{0.8} \cdot \frac{V_T}{V_{DD}} \quad (3)$$

Equations (2) and (3) describe the conversion formulae for the temperature signal in °C and °F.

5 Packaging

SHT3x-ARP sensors are provided in an open-cavity DFN package. DFN stands for dual flat no leads. The humidity sensor opening is centered on the top side of the package.

The sensor chip is made of silicon and is mounted to a lead frame. The latter is made of Cu plated with Ni/Pd/Au. Chip and lead frame are overmolded by an epoxy-based mold compound leaving the central die pad and I/O pins exposed for mechanical and electrical connection. Please note that the side walls of the sensor are diced and therefore these diced lead frame surfaces are not covered with the respective plating.

The package (except for the humidity sensor opening) follows JEDEC publication 95, design registration 4.20, small scale plastic quad and dual inline, square and rectangular, No-LEAD packages (with optional thermal enhancements) small scale (QFN/SON), Issue D.01, September 2009.

5.1 Traceability

All SHT3x-ARP sensors are laser marked for easy identification and traceability. The marking on the sensor top side consists of a pin-1 indicator and two lines of text.

The top line consists of the pin-1 indicator which is located in the top left corner and the product name. The small letter x stands for the accuracy class.

The bottom line consists of 6 letters. The first two digits XY (=AR) describe the output mode. The third letter (A) represents the manufacturing year (4 = 2014, 5 = 2015, etc). The last three digits (BCD) represent an alphanumeric tracking code. That code can be decoded by Sensirion only and allows for tracking on batch level through production, calibration and testing – and will be provided upon justified request.

If viewed from below pin 1 is indicated by triangular shaped cut in the otherwise rectangular die pad. The dimensions of the triangular cut are shown in Figure 12 through the labels T1 & T2.

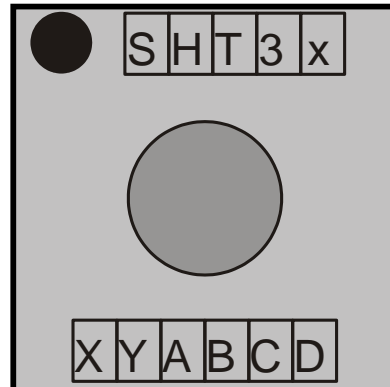

Figure 11 Top View of the SHT3x-ARP illustrating the laser marking.

5.2 Package Outline

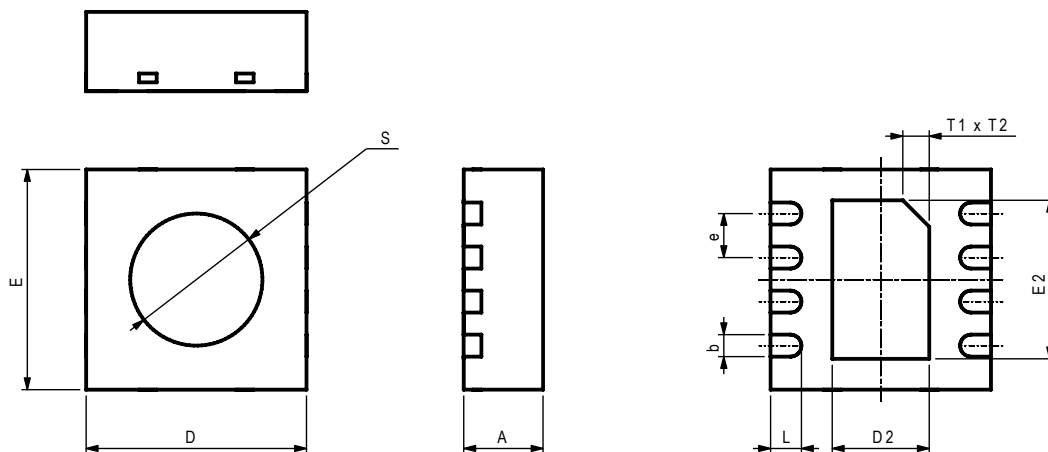

Figure 12 Dimensional drawing of SHT3x-ARP sensor package.

| Parameter | Symbol | Min | Nom. | Max | Units | Comments |
|--------------------|--------|------|---------|------|-------|---|
| Package height | A | 0.8 | 0.9 | 1 | mm | |
| Leadframe height | A3 | - | 0.2 | - | mm | Not shown in the drawing |
| Pad width | b | 0.2 | 0.25 | 0.3 | mm | |
| Package width | D | 2.4 | 2.5 | 2.6 | mm | |
| Center pad length | D2 | 1 | 1.1 | 1.2 | mm | |
| Package length | E | 2.4 | 2.5 | 2.6 | mm | |
| Center pad width | E2 | 1.7 | 1.8 | 1.9 | mm | |
| Pad pitch | e | - | 0.5 | - | mm | |
| Pad length | L | 0.25 | 0.35 | 0.45 | mm | |
| Max cavity | S | - | - | 1.5 | mm | Only as guidance. This value includes all tolerances, including displacement tolerances. Typically the opening will be smaller. |
| Center pad marking | T1xT2 | | 0.3x45° | | mm | indicates the position of pin 1 |

Table 7 Package outline

5.3 Land Pattern

Figure 13 shows the land pattern. The land pattern is understood to be the open metal areas on the PCB, onto which the DFN pads are soldered.

The solder mask is understood to be the insulating layer on top of the PCB covering the copper traces. It is recommended to design the solder mask as a Non-Solder Mask Defined (NSMD) type. For NSMD pads, the solder mask opening should provide a 60 µm to 75 µm design clearance between any copper pad and solder mask. As the pad pitch is only 0.5 mm we recommend to have one solder mask opening for all 4 I/O pads on one side.

For solder paste printing it is recommended to use a laser-cut, stainless steel stencil with electro-polished trapezoidal walls and with 0.1 or 0.125 mm stencil thickness. The length of the stencil apertures for the I/O pads should be the same as the PCB pads. However, the position of the stencil apertures should have an offset of 0.1 mm away from the center of the package. The die pad aperture should cover about 70 – 90 % of the die pad area –thus it should have a size of about 0.9 mm x 1.6 mm.

For information on the soldering process and further recommendation on the assembly process please consult the Application Note SHTxx_STsxx_Assembly_of_SMD_Packages, which can be found on the Sensirion webpage.

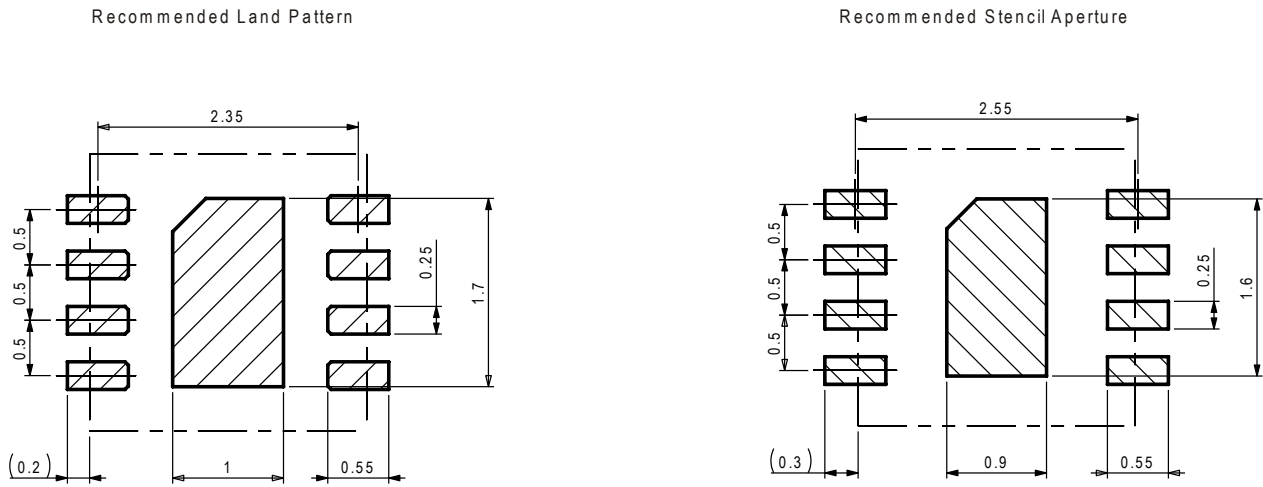

Figure 13 Recommended metal land pattern (left) and stencil apertures (right) for the SHT3x-ARP. The dashed lines represent the outer dimension of the DFN package. The PCB pads (left) and stencil apertures (right) are indicated through the shaded areas.

6 Shipping Package

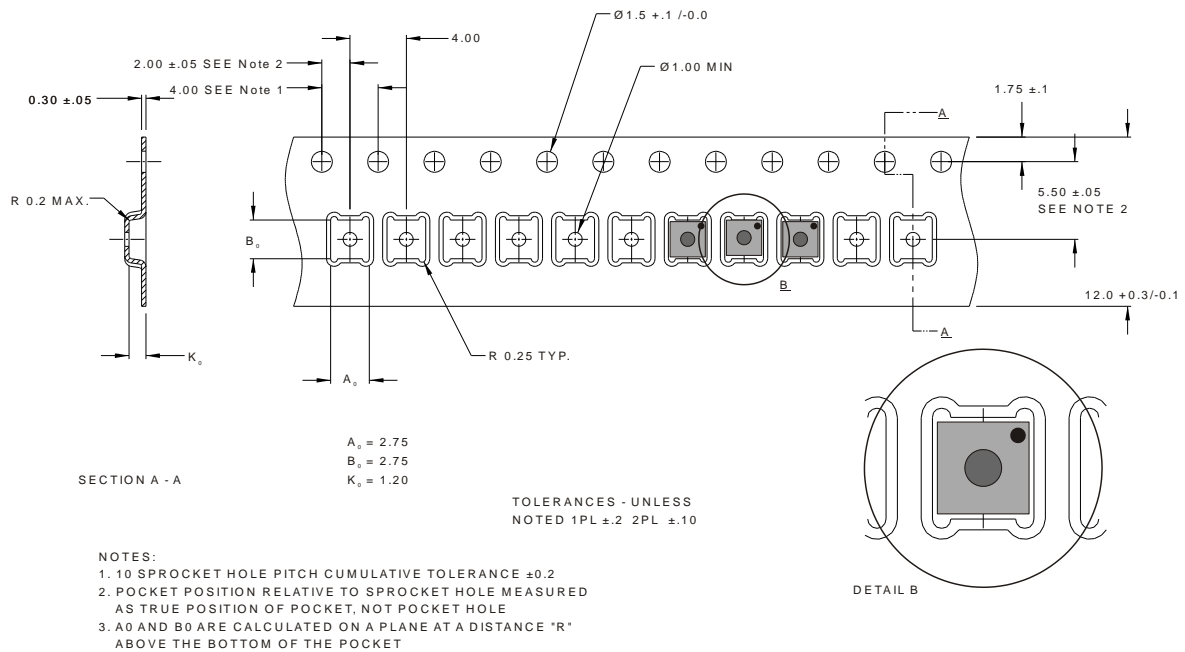

Figure 14 Technical drawing of the packaging tape with sensor orientation in tape. Header tape is to the right and trailer tape to the left on this drawing. Dimensions are given in millimeters.

7 Quality

Qualification of the SHT3x-ARP is performed based on the AEC Q 100 qualification test method.

7.1 Material Contents

The device is fully RoHS and WEEE compliant, e.g. free of Pb, Cd, and Hg.

8 Ordering Information

The SHT3x-ARP can be ordered in tape and reel packaging with different sizes, see Table 8. The reels are sealed into antistatic ESD bags. The document “SHT3x shipping package” that shows the details about the shipping package is available upon request.

| Name | Quantity | Order Number |
|------------------|----------|--------------|
| SHT30-ARP-B2.5kS | 2500 | 1-101381-01 |
| SHT30-ARP-B10kS | 10000 | 1-101175-01 |
| SHT31-ARP-B2.5kS | 2500 | 1-101385-01 |
| SHT31-ARP-B10kS | 10000 | 1-101178-01 |

Table 8 SHT3x-ARP ordering options.

9 Further Information

For more in-depth information on the SHT3x-ARP and its application please consult the following documents:

| Document Name | Description | Source |
|---|---|---|
| SHT3x Shipping Package | Information on Tape, Reel and shipping bags (technical drawing and dimensions) | Available upon request |
| SHTxx_STSxx Assembly of SMD Packages | Assembly Guide (Soldering Instruction,) | Available for download at the Sensirion humidity sensors download center: www.sensirion.com/humidity-download |
| SHTxx_STSxx Design Guide | Design guidelines for designing SHTxx/STSxx sensors into applications | Available for download at the Sensirion humidity sensors download center: www.sensirion.com/humidity-download |
| SHTxx Handling Instructions | Guidelines for proper handling of SHTxx humidity sensors (Reconditioning Procedure) | Available for download at the Sensirion humidity sensors download center: www.sensirion.com/humidity-download |
| Sensirion Humidity Sensor Specification Statement | Definition of sensor specifications. | Available for download at the Sensirion humidity sensors download center: www.sensirion.com/humidity-download |

Table 9 Documents containing further information relevant for the SHT3x-ARP.

Revision History

| Date | Version | Page(s) | Changes |
|----------------|---------|----------|---|
| October 2015 | 1 | | Initial release |
| January 2016 | 2 | 12 | Update ordering information |
| September 2018 | 3 | multiple | <p>Typo & formatting correction</p> <p>2 Added sensitivity at VDD=5.0V in Table 1</p> <p>2 Added sensitivity at VDD=5.0V and refined resolution in Table 2</p> <p>4 Limitation of T accuracies to VDD=4.5V...5.5V and refined max. accuracies in Figure 6</p> <p>4 Limitation of T accuracies to VDD=4.5V...5.5V and refined max and typ. accuracies in Figure 7</p> <p>5 Table 3: Updated V_{POR}, R_L and C_L values; replaced "Output current" with "Resistive load to VSS"; more detailed specification of supply current; refined table caption;</p> <p>5 Updated duration of reset pulse in Table 4</p> <p>5 Introduced "Ratings are only tested each at a time" in section 2.3.</p> <p>6 Updated Footnotes 9 and 10</p> <p>7 Updated nRESET description in Table 6</p> <p>7 Updated nRESET description in section 3.3</p> <p>8 Updated capacitor values and connect. in typ. application circuit in Figure 8</p> <p>11 Updated min. & max. values of pad length in Table 7</p> |