

## SHT4xl-Analog

### 4<sup>th</sup> Generation, High-Accuracy, 5V Relative Humidity and Temperature Analog Sensor Platform



#### Features

- Relative humidity accuracy  $\pm 2.5\%$  RH
- Temperature accuracy  $\pm 0.3\text{ }^{\circ}\text{C}$
- Supply voltage: 4.5...5.5 V
- Average current: 520  $\mu\text{A}$
- Analog voltage output 10-90%VDD
- Multiple out output characteristics available
- NIST traceable
- Operating range: 0...100 %RH, -40...125  $^{\circ}\text{C}$
- Fully functional in condensing environment
- Variable power heater
- Mature technology from global market leader
- Protection options available

#### General Description

Sensors from the SHT4xl-Analog sensor family, currently represented by the SHT40I-Analog, deliver an analog voltage output with several available output characteristics. An optional periodic variable power heater allows for operation in highly demanding environments, such as constant high humidity and condensing atmospheres. The four-pin dual-flat-no-leads package is suitable for surface mount technology (SMT) processing.

#### Device Overview

Products	Details
SHT40I-HD1B	base RH&T accur., standard ratiometric output characteristic, available in distribution.
SHT40I-ID1B	base RH&T accur., application specific output characteristics, only available at Sensirion.
SHT40I-JD1B	
SHT40I-KD1B	
SHT40I-LD1B	
SHT40I-xD1B	x: Placeholder for a family of products with base RH&T accur. and customer specific output characteristic

Full product list on page 18

#### Functional Block Diagram

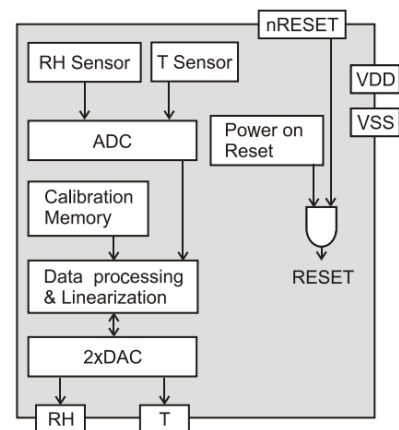

# Contents

Features .....	1
General Description .....	1
Device Overview .....	1
Functional Block Diagram .....	1
1 Humidity and Temperature Sensor Specifications .....	3
1.1 Relative Humidity .....	3
1.2 Temperature .....	4
1.3 Recommended Operating Conditions .....	4
2 Electrical Specifications .....	5
2.1 Electrical Characteristics .....	5
2.2 Timings .....	5
2.3 Absolute Maximum Ratings .....	6
3 Sensor Operation .....	6
3.1 Startup .....	6
3.2 Conversion of the Signal Output .....	6
3.3 Standard Output Characteristic Option: SHT40I-HD1B .....	7
3.4 Output Characteristic Option 2: SHT40I-ID1B .....	8
3.5 Output Characteristic Option 3: SHT40I-JD1B .....	9
3.6 Output Characteristic Option 4: SHT40I-KD1B .....	10
3.7 Output Characteristic Option 4: SHT40I-LD1B .....	11
3.8 Heater Operation for Anti-Creep Functionality in Highly Demanding Environments .....	13
4 Physical Specification .....	14
4.1 Package Description .....	14
4.2 Package Outline .....	14
4.3 Land Pattern .....	15
4.4 Pin Assignment & Laser Marking .....	15
4.5 Thermal Information .....	16
5 Quality and Material Contents .....	16
6 Tape and Reel Packaging .....	17
7 Product Nomenclature .....	18
8 Ordering Information .....	19
9 Bibliography .....	19
10 Revision History .....	19

# 1 Humidity and Temperature Sensor Specifications

Every SHT40I-Analog is individually tested, calibrated, and identifiable. For the calibration, Sensirion uses transfer standards, which are subject to a scheduled calibration procedure. The calibration of the reference, used for the calibration of the transfer standards, is NIST traceable through an ISO/IEC 17025 accredited laboratory.

## 1.1 Relative Humidity

Parameter	Conditions	Value	Units
SHT40I RH accuracy <sup>1</sup>	typ.	±2.5	%RH
	max.	see <b>Figure 1</b>	-
Repeatability <sup>2</sup>	typ.	0.5	%RH
Resolution <sup>3</sup>	-	0.01	%RH
Hysteresis	At 25°C	±0.8	%RH
Specified range <sup>4</sup>	extended <sup>5</sup>	0 to 100	%RH
Response time <sup>6</sup>	$t_{63\%}$	4	s
Long-term drift <sup>7</sup>	typ.	<0.2	%RH/y
Sensitivity (RH range: 0...100%)	VDD=5.0 V	40	mV/%RH

**Table 1:** General relative humidity sensor specifications.

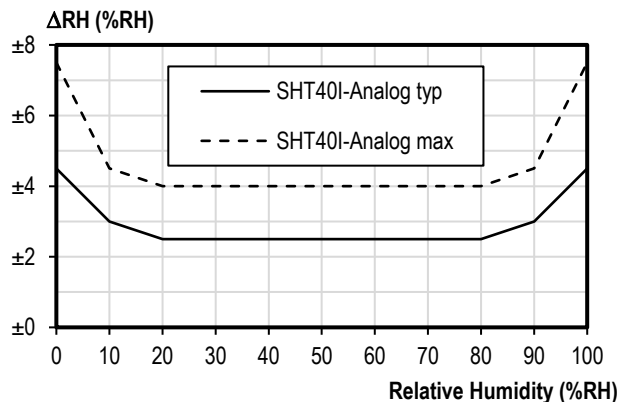

**Figure 1:** SHT40I-Analog typical and maximal relative humidity accuracy at 25 °C.

<sup>1</sup> For definition of typ. and max. accuracy, please refer to the document “Sensirion Humidity Sensor Specification Statement”.

<sup>2</sup> The stated repeatability is 3 times the standard deviation (3σ) of multiple consecutive measurement values at constant conditions and is a measure for the noise on the physical sensor output.

<sup>3</sup> Resolution of A/D converter.

<sup>4</sup> Specified range refers to the range for which the humidity or temperature sensor specification is guaranteed.

<sup>5</sup> For details about recommended humidity and temperature operating range, please refer to section 1.3.

<sup>6</sup> Time for achieving 63% of a humidity step function, measured at 25°C and 1 m/s airflow. Humidity response time in the application depends on the design-in of the sensor.

<sup>7</sup> Typical value for operation in normal RH/T operating range. Value may be higher in environments with vaporized solvents, out-gassing tapes, adhesives, packaging materials, etc. For more details please refer to Handling Instructions.

**1.2 Temperature**

Parameter	Conditions	Value	Units
SHT40I T Accuracy <sup>1</sup>	typ.	±0.3	°C
	max.	see <b>Figure 2</b>	-
Repeatability <sup>2</sup>	typ.	0.1	°C
Resolution <sup>3</sup>	-	0.01	°C
Specified range <sup>4</sup>	-	-40 to +125	°C
Response time <sup>8</sup>	$t_{63\%}$	2	s
Long-term drift	typ.	<0.03	°C/y
Sensitivity	VDD=5.0 V	23	mV/°C

**Table 2:** General temperature sensor specifications.

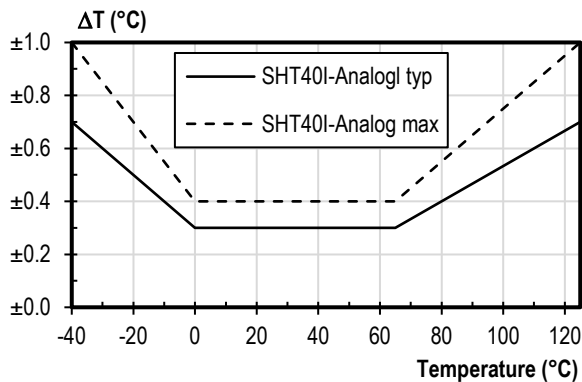

**Figure 2:** SHT40I analog (output characteristics H,I,J, K, *vide infra*) typical and maximal temperature accuracy, where model SHT40I-ID1B is only specified between -20°C and +80°C.

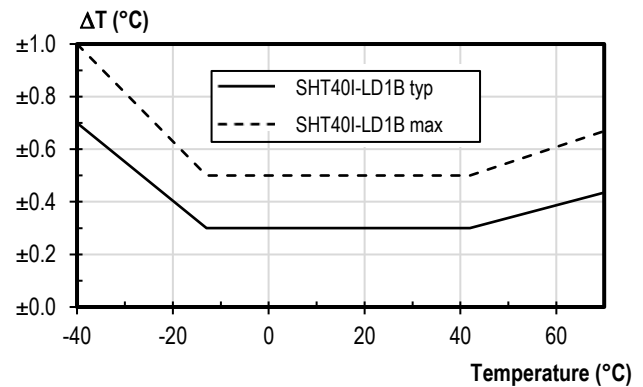

**Figure 3:** SHT40I-LD1B typical and maximal temperature accuracy.

**1.3 Recommended Operating Conditions**

The sensor shows best performance when operated within the recommended normal temperature and humidity range of 5 °C ... 60 °C and 20 %RH ... 80 %RH, respectively. Long term exposure to conditions outside recommended normal range, especially at high relative humidity, may temporarily offset the RH signal (e.g. +3 %RH after 60 h at > 80 %RH). After returning into the recommended normal temperature and humidity range the sensor will recover to within specifications by itself. Prolonged exposure to extreme conditions may accelerate ageing.

To ensure stable operation of the humidity sensor, the conditions described in the Sensirion Handling Instructions [1] regarding exposure to volatile organic compounds have to be met. Please note as well that this does apply not only to transportation and manufacturing, but also to operation of the SHT40I.

<sup>8</sup> Temperature response time depends on heat conductivity of sensor substrate and design-in of sensor in application.

## 2 Electrical Specifications

Valid for all electrical specifications: Typical values correspond to  $V_{DD} = 5\text{ V}$  and  $T = 25\text{ °C}$ . Min. and max. values are valid in the full temperature range  $-40\text{ °C} \dots 125\text{ °C}$ , at declared  $V_{DD}$  levels and are based on characterization.

### 2.1 Electrical Characteristics

Parameter	Symbol	Conditions	Min	Typ.	Max	Units	Comments
Supply voltage	$V_{DD}$		4.5	5	5.5	V	-
Power-up/down level	$V_{POR}$	Static power supply	0.75	0.9	1.0	V	<b>Above:</b> Communication possible, but measurement value not guaranteed to be in specs (compare supply voltage). <b>Below:</b> System resets completely
Slew rate change of the supply voltage	$V_{DD, \text{slew}}$		-	-	20	V/ms	Voltage changes on the VDD line between VDD, min and VDD, max should be slower than the maximum slew rate; faster slew rates may lead to reset
Supply current		Measurement	-	520	850	$\mu\text{A}$	At resistive load 1 MOhm
Resistive load to VSS			1	-	-	kOhm	
Capacitive load			-	-	100	nF	

**Table 3:** Electrical specifications.

### 2.2 Timings

Parameter	Symbol	Conditions	Min.	Typ.	Max.	Units	Comments
Power-up time	$t_{PU}$	After hard reset, $V_{DD} \geq V_{POR}$	-	7	15	ms	Time between $V_{DD}$ reaching $V_{POR}$ and sensor entering idle state
Analog out settling time				200		ms	Dependent on band width of the reference path; Value for default setting of BW=0 (10Hz)
Measurement interval	$t_{MeasInt}$	Heater disabled.		0.5		s	With enabled heater refer to <b>Table 9</b> .

**Table 4** System timing specifications.

### 2.3 Absolute Maximum Ratings

Stress levels beyond those listed in Table 5 may cause permanent damage or affect the reliability of the device. These are stress ratings only and functional operation of the device at these conditions is not guaranteed. Ratings are only tested each at a time.

Parameter	Rating
Max. voltage on any pin	$V_{SS} - 0.3 \text{ V} \dots V_{DD} + 0.3 \text{ V}$
VDD	6 V
Operating temperature range	-40 °C ... 125 °C
Storage temperature range <sup>9</sup>	-40 °C ... 150 °C
ESD HBM	2 kV
ESD CDM	750 V
Latch up, JESD78 Class II, 125°C	+/-100 mA

**Table 5:** Absolute maximum ratings.

## 3 Sensor Operation

### 3.1 Startup

The sensor automatically starts up after reaching the power-up threshold voltage VPOR specified in Table 3. After reaching this threshold voltage the sensor needs the time tPU until the first measurement signal is available as voltage output on the respective output pins. During that time the temperature and humidity pins have an undefined state.

After sensor startup, the standard measurement interval is 0.5 s (see also **Table 4** and **Table 9**).

### 3.2 Conversion of the Signal Output

The physical values as measured by the sensor are mapped to a voltage output (VT, VRH as maximum 10 to 90% of VDD).

Prior to conversion into a voltage signal, the physical values are linearized and compensated for temperature and supply voltage effects by the sensor. Additionally, the voltage output is calibrated for each sensor. Hence the relationship between temperature and humidity and the voltage output is the same for each sensor with respect to the output characteristic type, within the limits given by the accuracy (Table 1 and Table 2).

This allows to describe the relationship between physical values (RH and T) and the voltage output for temperature and humidity (VT, VRH) through generic formulae given in sections 3.3 to 3.6.

Please note that some of the RH conversion formulae allow values outside of the range of 0 %RH ... 100 %RH. Relative humidity values which are smaller than 0 %RH and larger than 100 %RH are non-physical, however these “uncropped” values might be found beneficial in some cases (e.g. when the distribution of the sensors at the measurement boundaries are of interest). For all users who do not want to engage in evaluation of these non-physical values, cropping of the RH signal to the range of 0 %RH ... 100 %RH is advised.

For selecting the different output characteristics, please refer to sections 7 and 8, as well as **Table 6**.

<sup>9</sup> The recommended storage temperature range is 10-50°C. Please consult the document “SHTxx Handling Instructions” for more information.

SHT3x-Analog	SHT40I-Analog
SHT3x-ARP	SHT40I-HD1B
SHT3x-T1RP	SHT40I-ID1B
SHT3x-RARP	SHT40I-JD1B
SHT3x-R1RP	SHT40I-KD1B
SHT3x-T2RP	SHT40I-LD1B

**Table 6:** Naming of available SHT3x analog and corresponding SHT40I analog output characteristics.

**3.3 Standard Output Characteristic Option: SHT40I-HD1B**

(1) 
$$RH = \left(-12.5 + 125 \cdot \frac{V_{RH}}{V_{DD}}\right) \%RH = -\frac{10}{0.8} + \frac{100}{0.8} \cdot \frac{V_{RH}}{V_{DD}} \%RH$$

(2) 
$$T = \left(-66.875 + 218.75 \cdot \frac{V_T}{V_{DD}}\right) ^\circ C = -45 - \frac{17.5}{0.8} + \frac{175}{0.8} \cdot \frac{V_T}{V_{DD}} ^\circ C$$
 See Figure 4

(3) 
$$T = \left(-88.375 + 393.75 \cdot \frac{V_T}{V_{DD}}\right) ^\circ C = -49 - \frac{31.5}{0.8} + \frac{315}{0.8} \cdot \frac{V_T}{V_{DD}} ^\circ F$$

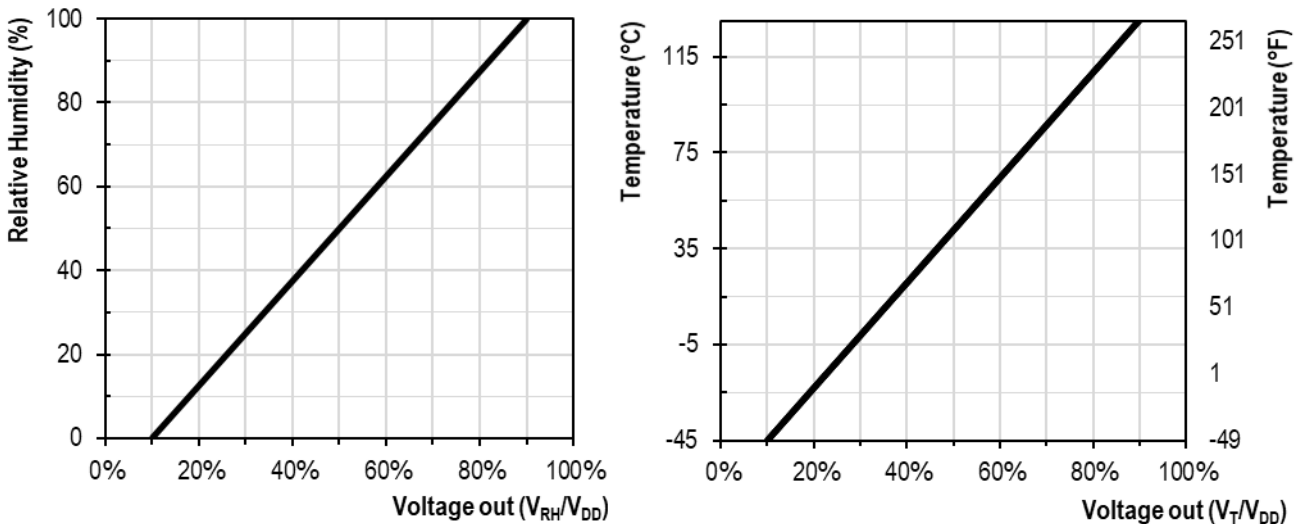

**Figure 4:** Relationship between the analog voltage output and the measured relative humidity and temperature corresponding to equations 1, 2, and 3 for the SHT40I-HD1B.

**3.4 Output Characteristic Option 2: SHT40I-ID1B**

$$(4) \quad RH = -\frac{19.7}{0.54} + \frac{100}{0.54} \cdot \frac{V_{RH}}{V_{DD}} \%RH$$

$T$ (°C)	$V_T/V_{DD}$ (%)	$T$ (°C)	$V_T/V_{DD}$ (%)	$T$ (°C)	$V_T/V_{DD}$ (%)	$T$ (°C)	$V_T/V_{DD}$ (%)
-20	89.81	5	68.24	30	39.76	55	19.55
-19.5	89.51	5.5	67.68	30.5	39.21	55.5	19.29
-19	89.2	6	67.13	31	38.65	56	19.03
-18.5	88.89	6.5	66.58	31.5	38.13	56.5	18.77
-18	88.58	7	66.02	32	37.67	57	18.51
-17.5	88.28	7.5	65.47	32.5	37.22	57.5	18.25
-17	87.97	8	64.91	33	36.76	58	18
-16.5	87.66	8.5	64.36	33.5	36.3	58.5	17.74
-16	87.36	9	63.8	34	35.84	59	17.48
-15.5	87.05	9.5	63.24	34.5	35.38	59.5	17.22
-15	86.74	10	62.65	35	34.93	60	16.96
-14.5	86.44	10.5	62.06	35.5	34.47	60.5	16.7
-14	86.13	11	61.47	36	34.01	61	16.44
-13.5	85.82	11.5	60.89	36.5	33.55	61.5	16.18
-13	85.52	12	60.3	37	33.09	62	15.93
-12.5	85.19	12.5	59.71	37.5	32.64	62.5	15.67
-12	84.75	13	59.12	38	32.18	63	15.41
-11.5	84.31	13.5	58.53	38.5	31.72	63.5	15.15
-11	83.87	14	57.94	39	31.26	64	14.89
-10.5	83.43	14.5	57.36	39.5	30.8	64.5	14.65
-10	82.98	15	56.77	40	30.35	65	14.47
-9.5	82.54	15.5	56.18	40.5	29.89	65.5	14.28
-9	82.1	16	55.59	41	29.43	66	14.1
-8.5	81.66	16.5	55	41.5	28.97	66.5	13.91
-8	81.22	17	54.42	42	28.51	67	13.73
-7.5	80.77	17.5	53.83	42.5	28.09	67.5	13.54
-7	80.33	18	53.24	43	27.74	68	13.35
-6.5	79.89	18.5	52.65	43.5	27.38	68.5	13.17
-6	79.45	19	52.06	44	27.03	69	12.98
-5.5	79.01	19.5	51.47	44.5	26.67	69.5	12.8
-5	78.56	20	50.89	45	26.32	70	12.61
-4.5	78.12	20.5	50.31	45.5	25.97	70.5	12.43
-4	77.68	21	49.75	46	25.61	71	12.24
-3.5	77.24	21.5	49.2	46.5	25.26	71.5	12.06
-3	76.8	22	48.64	47	24.9	72	11.87
-2.5	76.35	22.5	48.09	47.5	24.55	72.5	11.69
-2	75.91	23	47.53	48	24.19	73	11.5
-1.5	75.45	23.5	46.98	48.5	23.84	73.5	11.31
-1	74.89	24	46.42	49	23.48	74	11.13
-0.5	74.34	24.5	45.87	49.5	23.13	74.5	10.94
0	73.78	25	45.31	50	22.77	75	10.76
0.5	73.23	25.5	44.76	50.5	22.42	75.5	10.6
1	72.67	26	44.2	51	22.07	76	10.53
1.5	72.12	26.5	43.65	51.5	21.71	76.5	10.47
2	71.57	27	43.09	52	21.36	77	10.4
2.5	71.01	27.5	42.54	52.5	21	77.5	10.33
3	70.46	28	41.98	53	20.65	78	10.27
3.5	69.9	28.5	41.43	53.5	20.32	78.5	10.2
4	69.35	29	40.87	54	20.07	79	10.13
4.5	68.79	29.5	40.32	54.5	19.81	79.5	10.07

See Figure 5.

N.B.: The RH conversion formula (4) allows values outside of the range of 0 %RH ... 100 %RH. Relative humidity values which are smaller than 0 %RH and larger than 100 %RH are non-physical, however these “uncropped” values might be found beneficial in some cases (e.g. when the distribution of the sensors at the measurement boundaries are of interest). For all users who do not want to engage in evaluation of these non-physical values, cropping of the RH signal to the range of 0 %RH ... 100 %RH is advised.



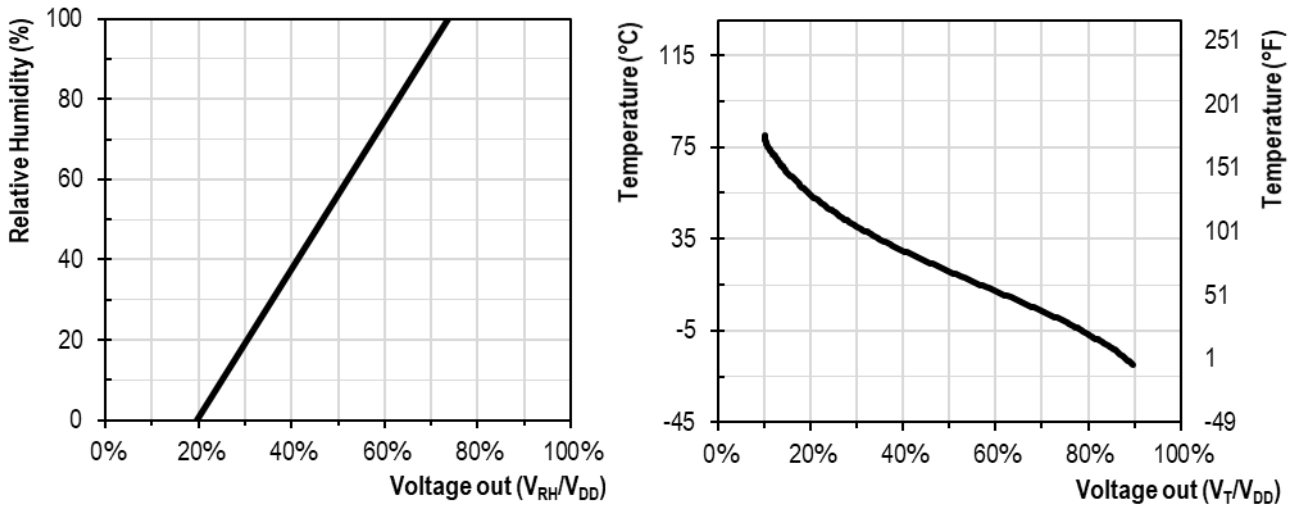

**Figure 5:** Relationship between the analog voltage output and the measured relative humidity and temperature corresponding to equations 4 and tabulated values in ( 5 ) for the SHT40I-ID1B.

**3.5 Output Characteristic Option 3: SHT40I-JD1B**

( 6 ) 
$$RH = -\frac{19.7}{0.54} + \frac{100}{0.54} \cdot \frac{V_{RH}}{V_{DD}} \%RH$$

( 7 ) 
$$T = \left( -66.875 + 218.75 \cdot \frac{V_T}{V_{DD}} \right) ^\circ C = -45 - \frac{17.5}{0.8} + \frac{175}{0.8} \cdot \frac{V_T}{V_{DD}} ^\circ C$$
 See **Figure 6**.

( 8 ) 
$$T = \left( -88.375 + 393.75 \cdot \frac{V_T}{V_{DD}} \right) ^\circ C = -49 - \frac{31.5}{0.8} + \frac{315}{0.8} \cdot \frac{V_T}{V_{DD}} ^\circ F$$

N.B.: The RH conversion formula (6) allows values outside of the range of 0 %RH ... 100 %RH. Relative humidity values which are smaller than 0 %RH and larger than 100 %RH are non-physical, however these “uncropped” values might be found beneficial in some cases (e.g. when the distribution of the sensors at the measurement boundaries are of interest). For all users who do not want to engage in evaluation of these non-physical values, cropping of the RH signal to the range of 0 %RH ... 100 %RH is advised.

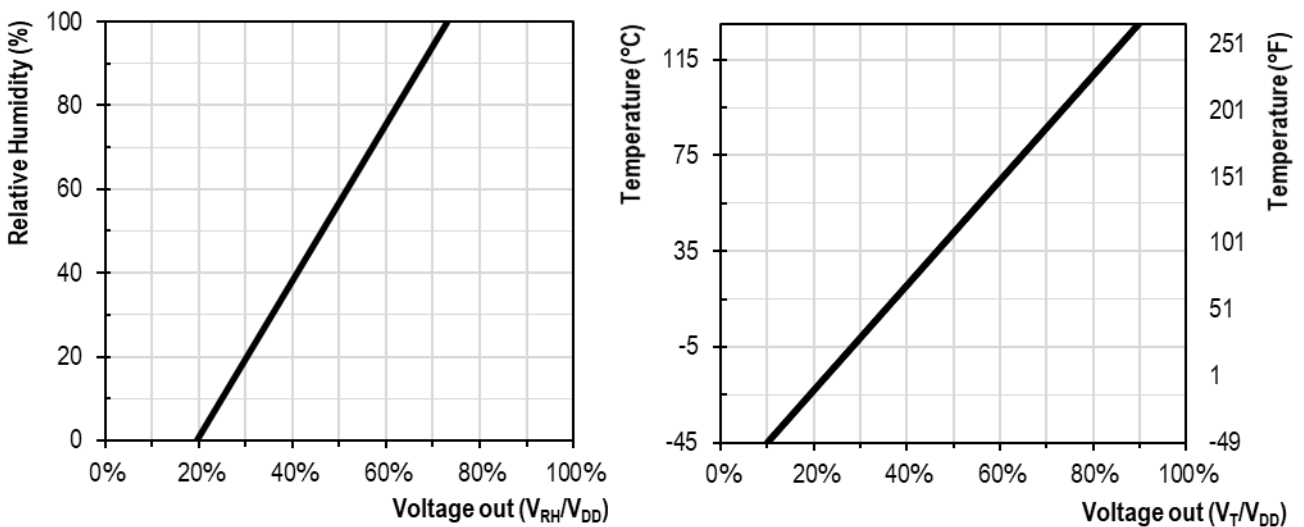

**Figure 6:** Relationship between the analog voltage output and the measured relative humidity and temperature corresponding to equations 6, 7, and 8 for the SHT40I-JD1B.

**3.6 Output Characteristic Option 4: SHT40I-KD1B**

( 9 ) 
$$RH = -\frac{16.44}{0.6489} + \frac{100}{0.6489} \cdot \frac{V_{RH}}{V_{DD}} \%RH$$

See **Figure 7**.

N.B.: The RH conversion formula (9) allows values outside of the range of 0 %RH ... 100 %RH. Relative humidity values which are smaller than 0 %RH and larger than 100 %RH are non-physical, however these “uncropped” values might be found beneficial in some cases (e.g. when the distribution of the sensors at the measurement boundaries are of interest). For all users who do not want to engage in evaluation of these non-physical values, cropping of the RH signal to the range of 0 %RH ... 100 %RH is advised.

The T output is left floating in this configuration and does not deliver an output signal.

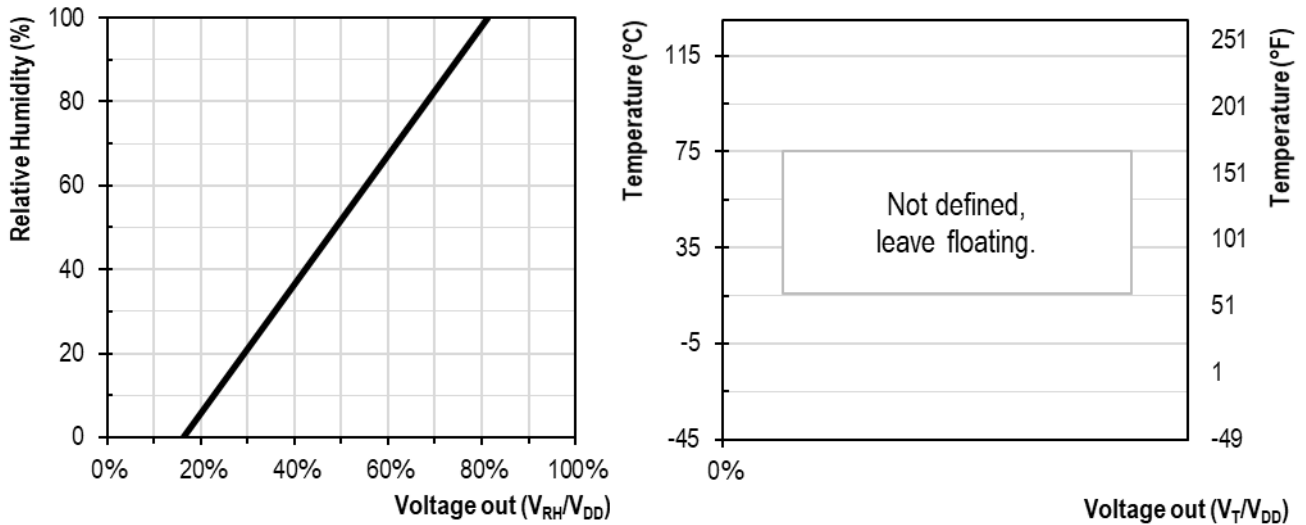

**Figure 7:** Relationship between the analog voltage output and the measured relative humidity corresponding to equation 9 for the SHT40I-KD1B.

**3.7 Output Characteristic Option 4: SHT40I-LD1B**

<i>RH</i> (%)	$V_{RH}/V_{DD}$ (%)	<i>RH</i> (%)	$V_{RH}/V_{DD}$ (%)
0	0.197	51	0.472
1	0.202	52	0.478
2	0.208	53	0.483
3	0.213	54	0.489
4	0.219	55	0.494
5	0.224	56	0.499
6	0.229	57	0.505
7	0.235	58	0.51
8	0.24	59	0.516
9	0.246	60	0.521
10	0.251	61	0.526
11	0.256	62	0.532
12	0.262	63	0.537
13	0.267	64	0.543
14	0.273	65	0.548
15	0.278	66	0.553
16	0.283	67	0.559
17	0.289	68	0.564
18	0.294	69	0.57
19	0.3	70	0.575
20	0.305	71	0.58
21	0.31	72	0.586
22	0.316	73	0.591
23	0.321	74	0.597
24	0.327	75	0.602
25	0.332	76	0.607
26	0.337	77	0.613
27	0.343	78	0.618
28	0.348	79	0.624
29	0.354	80	0.629
30	0.359	81	0.634
31	0.364	82	0.64
32	0.37	83	0.645
33	0.375	84	0.651
34	0.381	85	0.656
35	0.386	86	0.661
36	0.391	87	0.667
37	0.397	88	0.672
38	0.402	89	0.678
39	0.408	90	0.683
40	0.413	91	0.688
41	0.418	92	0.694
42	0.424	93	0.699
43	0.429	94	0.705
44	0.435	95	0.71
45	0.44	96	0.715
46	0.445	97	0.721
47	0.451	98	0.726
48	0.456	99	0.732
49	0.462	100	0.737
50	0.467		

**Table 7:** Look-up table for conversion from normalized output voltage to relative humidity (%) for the SHT40I-LD1B.

$T$ (°C)	$V_T/V_{DD}$ (%)	$T$ (°C)	$V_T/V_{DD}$ (%)	$T$ (°C)	$V_T/V_{DD}$ (%)
-40	0.126	10	0.475	60	0.869
-39	0.131	11	0.484	61	0.874
-38	0.136	12	0.494	62	0.879
-37	0.141	13	0.503	63	0.883
-36	0.145	14	0.513	64	0.888
-35	0.15	15	0.523	65	0.893
-34	0.155	16	0.532	66	0.898
-33	0.16	17	0.542	67	0.903
-32	0.165	18	0.551	60	0.869
-31	0.17	19	0.561	61	0.874
-30	0.174	20	0.57	62	0.879
-29	0.179	21	0.58	63	0.883
-28	0.184	22	0.59	64	0.888
-27	0.189	23	0.599	65	0.893
-26	0.194	24	0.609	66	0.898
-25	0.199	25	0.618	67	0.903
-24	0.203	26	0.628	60	0.869
-23	0.208	27	0.637	61	0.874
-22	0.213	28	0.647	62	0.879
-21	0.218	29	0.657	63	0.883
-20	0.223	30	0.666	64	0.888
-19	0.228	31	0.676	65	0.893
-18	0.232	32	0.685		
-17	0.237	33	0.695		
-16	0.242	34	0.704		
-15	0.247	35	0.714		
-14	0.252	36	0.723		
-13	0.257	37	0.733		
-12	0.264	38	0.743		
-11	0.274	39	0.752		
-10	0.283	40	0.762		
-9	0.293	41	0.771		
-8	0.303	42	0.781		
-7	0.312	43	0.787		
-6	0.322	44	0.792		
-5	0.331	45	0.797		
-4	0.341	46	0.802		
-3	0.35	47	0.806		
-2	0.36	48	0.811		
-1	0.369	49	0.816		
0	0.379	50	0.821		
1	0.389	51	0.826		
2	0.398	52	0.83		
3	0.408	53	0.835		
4	0.417	54	0.84		
5	0.427	55	0.845		
6	0.436	56	0.85		
7	0.446	57	0.855		
8	0.456	58	0.859		
9	0.465	59	0.864		

**Table 8:** Loo-up table for conversion from normalized output voltage to temperature (°C) for the SHT40I-LD1B.

**3.8 Heater Operation for Anti-Creep Functionality in Highly Demanding Environments**

Operation of any humidity sensor in high humidity or condensing environments for extended periods of time and/or at high temperature, increases the risk for gradual incorporation of excess water into the sensor element, which in turn leads to overestimated humidity, commonly denoted as sensor creep. Sensirion’s SHT4x generation is already the most creep-resistant sensor on the market, due to extensive research and material optimization. However, creep can never be fully suppressed due to physico-chemical material limitations of all known polymers. In order to circumvent this issue, the SHT4x generation features a powerful integrated on-chip heater, that allows for creep reduction by removing excess water, when necessary.

While the digital models of the SHT4x family feature user-selectable heating modes, the analog version comprises an optional factory-set periodical heater, keeping the sensor element in mint state during all, no matter how demanding, operation modes. The periodic heating-measurement cycle proceeds according to the following steps:

1. The heater is enabled with pre-defined power (up to 200 mW) and timer (up to 2 s) according to **Table 9**. The timers for the measurement interval ( $t_{MeasInt}$ ) and the heater-on duration ( $t_{Heat}$ ) are started.
2. After the heater is turned off, the sensor remains in idle mode for  $t_{MeasInt} - t_{Heat}$ . When defining the timing specifications, customers must ensure to not select combinations where  $t_{MeasInt} < t_{Heat}$ , which would result in impaired measurements.
3. After  $t_{MeasInt}$  is reached, a humidity and temperature measurement is started and the cycle starts from the beginning.

The heater configuration is a factory setting and can be ordered with the following parameters:

Parameter	Selectable Values
Heater Power	0 (=off), 100, 150, 200 mW
Heater-on Duration ( $t_{Heat}$ )	0.1, 0.5, 1, 2 s $\pm$ 15%
Measurement Interval ( $t_{MeasInt}$ ), if heater is enabled, otherwise: 0.5s)	0.5, 15, 30, 45, 60, 75, 90 s $\pm$ 15%

**Table 9:** Available heater parameters.

**Possible Heater Use Cases**

There will be dedicated Sensirion application notes elaborating on various use cases of the heater. In general, the applications of the on-chip heater comprise:

1. Removal of condensed / spray water on the sensor surface. Although condensed water is not a reliability / quality problem to the sensor, it might make the sensor non-responsive to RH changes in the air as long as there is liquid water on the surface.
2. Creep-free operation in high humid environments. Periodic heating pulses allow for creep-free high-humidity measurements for extended times.

## 4 Physical Specification

### 4.1 Package Description

SHT40I is provided in an open-cavity dual flat no lead (DFN) package. The humidity sensor opening is centered on the top side of the package. The sensor chip is made of silicon, hosted on a copper lead frame and overmolded by an epoxy-based mold compound. Exposed bottom side of the leadframe with the metallic contacts is Ni/Pd/Au coated, side walls are bare copper. Moisture sensitivity level (MSL) of 1 according to IPC/JEDEC J-STD-020 is achieved. It is recommended to process the sensors within one year after date of delivery.

### 4.2 Package Outline

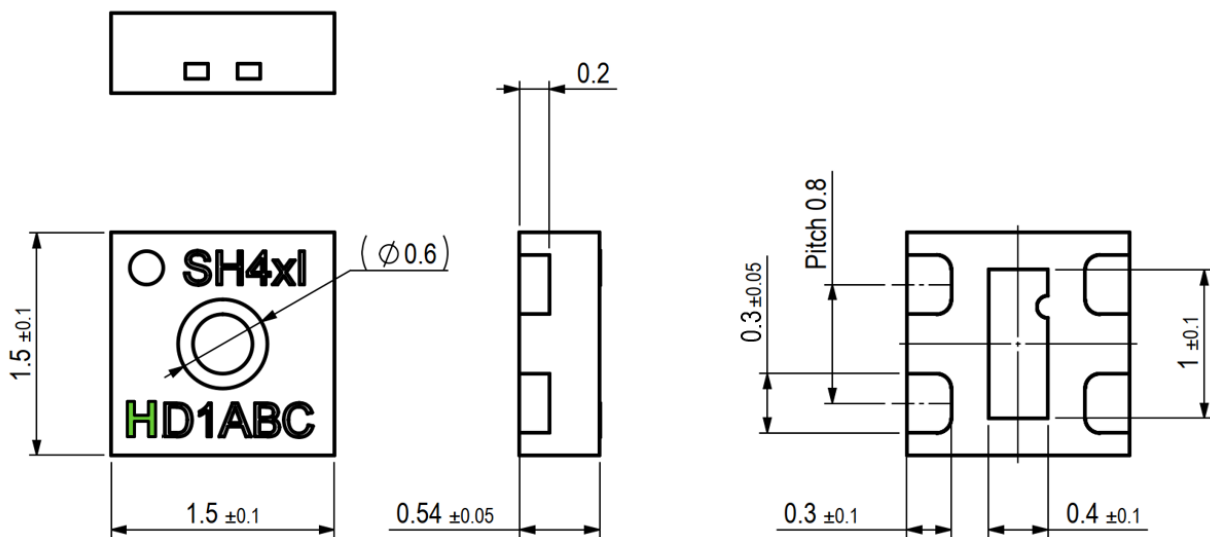
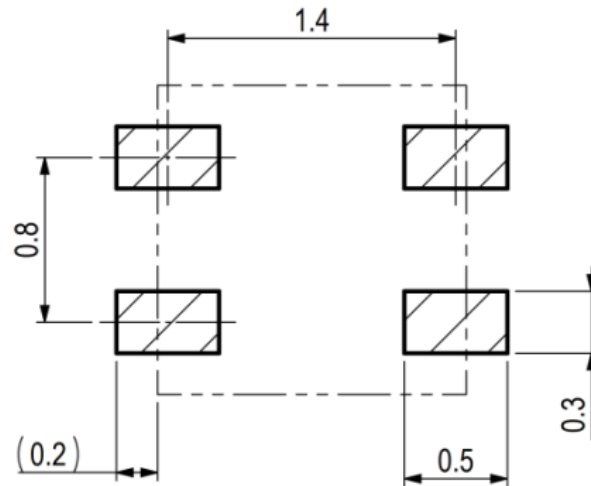

**Figure 8:** Dimensional drawing of SHT40I analog including package tolerances (units mm), where the H (here highlighted in green for better identification) serves as indicator for the standard analog interface. Other letters alphabetically after the letter H, indicate other versions of the analog interface, as detailed in **Table 11** and described in section 4.4.

**4.3 Land Pattern**

The land pattern is recommended to be designed according to the used PCB and soldering process together with the physical outer dimensions of the sensor. For reference, the land pattern used with Sensirion’s PCBs and soldering processes is given in **Figure 9**.

Soldering of the central die pad is optional. Sensirion recommends to not solder the central die pad because the sensor can reach higher temperatures upon heater activation.



**Figure 9:** Recommended land pattern (in mm). Details can vary and depend on used PCBs and solder processes. There shall be no copper under the sensor other than at the pin pads.

**4.4 Pin Assignment & Laser Marking**

Pin	Name	Comments
1	AOUT-RH	Analog Out RH
2	AOUT-T	Analog Out T
3	VDD	Supply voltage
4	VSS	Ground

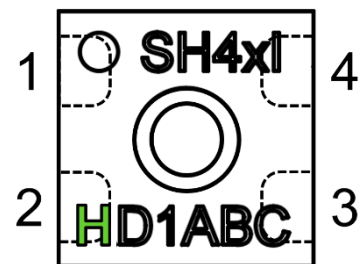

**Figure 10:** Pin assignment (transparent top view). Dashed lines are only visible if sensor is viewed from below. The die pad is not directly connected to any pin. The laser marking consists of two lines, indicated in **Figure 8** and **Figure 10**. In the first line a filled circle serves as pin-1 indicator and is followed by “SH4”. The fourth character will indicate the accuracy class of this product (here “x” serves as place holder). Lastly, “I” indicates the industrial grade. In the second line, the first three characters specify the product characteristics according to positions 7, 8 and 9 of **Table 11**. The second three characters serve as internal batch tracking code.

**4.5 Thermal Information**

Symbol	Description	Heater off, die pad soldered (K/W)	Heater on, die pad soldered (K/W)	Heater off, die pad not soldered (K/W)	Heater on, die pad not soldered (K/W)
$R_{\theta JA}$	Junction-to-ambient thermal resistance	246	308	<b>297</b>	<b>357</b>
$R_{\theta JC}$	Junction-to-case thermal resistance	189	255	<b>191</b>	<b>257</b>
$R_{\theta JB}$	Junction-to-board thermal resistance	159	225	<b>193</b>	<b>258</b>
$\Psi_{JB}$	Junction-to-board characterization param.	159	223	<b>191</b>	<b>254</b>
$\Psi_{JT}$	Junction-to-top characterization param.	38	105	<b>44</b>	<b>112</b>

**Table 10:** Typical values for thermal metrics. In the “heater on” columns a heater power of 200 mW was assumed. Soldering of the die pad is not recommended, therefore the two right hand side columns are bold. Values are based on simulation.

**5 Quality and Material Contents**

Qualification of SHT40I is performed based on the JEDEC JESD47 qualification test method. Qualification pending. The device is fully RoHS and WEEE compliant, e.g. free of Pb, Cd, and Hg. For general remarks of best practice in processing humidity sensor please refer to the handling instructions [1].



## 6 Tape and Reel Packaging

All specifications for the tape and reel packaging can be found in **Figure 11**. Reel diameters are 13 inch and 8 inch, for the 10k and the 2.5k packaging sizes, respectively.

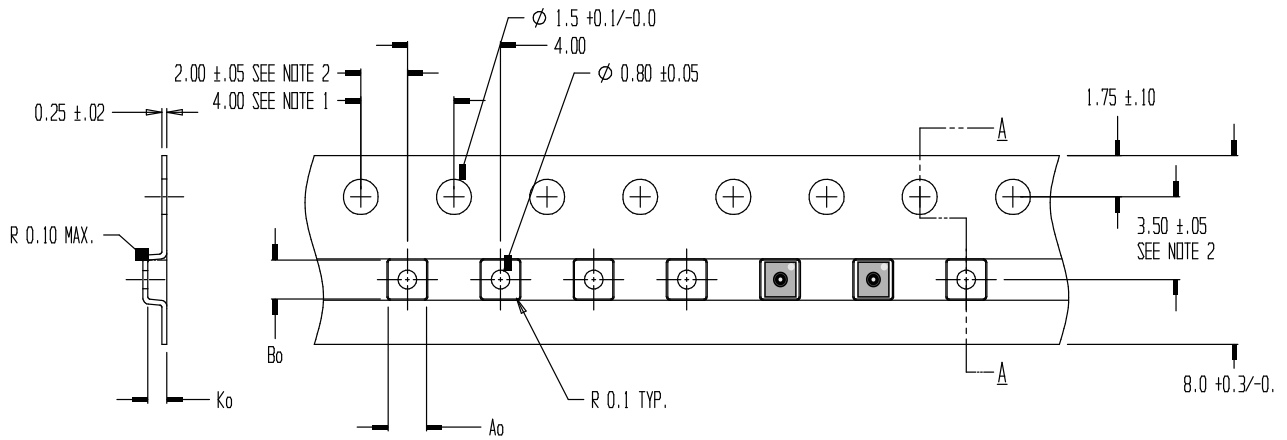

NOTES:

1. 10 SPROCKET HOLE PITCH CUMULATIVE TOLERANCE  $\pm 0.2$
2. POCKET POSITION RELATIVE TO SPROCKET HOLE MEASURED AS TRUE POSITION OF POCKET, NOT POCKET HOLE
3.  $A_0$  AND  $B_0$  ARE CALCULATED ON A PLANE AT A DISTANCE "R" ABOVE THE BOTTOM OF THE POCKET.

$A_0 = 1.65 \pm 0.05$   
 $B_0 = 1.65 \pm 0.05$   
 $K_0 = 0.81 \pm 0.05$

TOLERANCES - UNLESS NOTED 1PL  $\pm 0.2$  2PL  $\pm 0.10$

**Figure 11:** Tape and reel specifications including sensor orientation in pocket (see indication of two sensors on the right side of the tape).

**7 Product Nomenclature**

position	value(s)	explanation
1	S	Sensirion
2	H	Humidity Signal
3	T	Temperature Signal
4	4	Fourth product generation
5	0	Base accuracy
6	I	Industrial version
7	-	delimiter
8	H I J K L ...	Standard ARP analog output characteristic Previously T1RP analog output characteristic Previously RARP analog output characteristic Previously R1RP analog output characteristic Previously T2RP analog output characteristic ...
9	D	DFN package
10	1	reserved
11	B P F	Blank package With removable protective cover for conformal coating (not available yet) With PTFE filter membrane (not available yet)
12	-	delimiter
13	R	Tape on reel packaging
14	2 3	Packaging article contains 2'500 pieces Packaging article contains 10'000 pieces

**Table 11:** SHT4xl product nomenclature.

## 8 Ordering Information

Material Description	Material Number	Details	Quantity (pcs)
SHT40I-HD1B-R2	3.000.636	base RH&T accuracy, standard ARP analog output characteristic	2'500
SHT40I-HD1B-R3	Upon request	base RH&T accuracy, standard ARP analog output characteristic	10'000
SHT40I-ID1B-R2	3.000.731	base RH&T accuracy, previously T1RP analog output characteristic	2'500
SHT40I-ID1B-R3	Upon request	base RH&T accuracy, previously T1RP analog output characteristic	10'000
SHT40I-JD1B-R2	3.000.732	base RH&T accuracy, previously RARP analog output characteristic	2'500
SHT40I-JD1B-R3	3.000.821	base RH&T accuracy, previously RARP analog output characteristic	10'000
SHT40I-KD1B-R2	3.000.733	base RH&T accuracy, previously R1RP analog output characteristic	2'500
SHT40I-KD1B-R3	3.000.822	base RH&T accuracy, previously R1RP analog output characteristic	10'000
SHT40I-LD1B-R2	3.000.694	base RH&T accuracy, previously T2RP analog output characteristic	2'500
SHT40I-LD1B-R2	Upon request	base RH&T accuracy, previously T2RP analog output characteristic	10'000

**Table 12.** SHT40I analog ordering options.

Sensor evaluation kits are only available for SHT40I-HD1B. Please note that the Sensirion Sensor Bridge only allows read-out of the RH parameter, since it only features one analog pin.

## 9 Bibliography

[1] Sensirion, "Handling Instructions for Humidity Sensors," 2020. [Online]. Available: [www.sensirion.com](http://www.sensirion.com).

## 10 Revision History

Date	Version	Page(s)	Changes
September 2021	0.1	all	First <b>preliminary</b> version
December 2021	0.2	1, 6, 7, 8, 9, 10 5 3, 4 12, 13 13 15, 16	Added multiple output characteristics Adapted electrical specifications and timings Added accuracy plots Updated package outline and land pattern Added pin assignment information Extended product nomenclature and ordering information
September 2022	1	all	Updated accuracy plots, article numbers, and wording changes.
November 2022	2	6	Corrected typo in ESD HBM