

UG324: Non-Isolated Buck Evaluation Board for the Si3404

The Si3404 non-isolated Buck evaluation board is a reference design for a power supply in a Power over Ethernet (PoE) Powered Device (PD) application.

This Si3404-Buck EVB provides a simple and low-cost solution with different output voltages and power levels.

The Si3404-Buck-5V EVB board is shown below. The Si3404 IC integrates an IEEE 802.03af compatible PoE interface as well as a current control-based dc/dc converter.

The Si3404 PD integrates a detection circuit, classification circuit, dc/dc switch, hotswap switch, TVS overvoltage protection, dynamic soft-start circuit, cycle-by-cycle current limit, thermal shutdown, and inrush current protection.

The switching frequency is set to 220 kHz by installing R10 = 88.7 kΩ.

KEY FEATURES

- IEEE 802.03af compliant
- Very small application PCB surface
- High efficiency
- High integration
- Low-profile 4 x 4 mm 20-pin QFN
- Integrated thermal shutdown protection
- Low BOM cost
- Integrated transient overvoltage protection

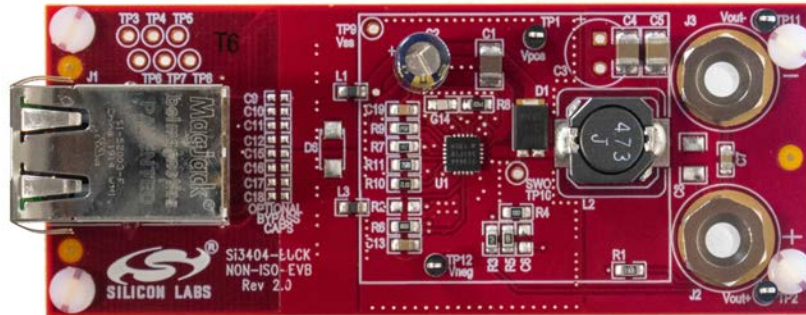

Parameter	Condition	Si3404-BUCK-3.3V	Si3404-BUCK-5V	Si3404-BUCK-12V	Si3404-BUCK-24V
PSE Input Voltage Range	Connector J1	37 V to 57 V			
PoE Type/Class	IEEE 802.3af	Type 1/Class 2		Type 1/Class 3	
Output Voltage/Current	Connectors J2–J3	3.3 V / 2.1 A	5 V / 1.4 A	12 V / 1.25 A	24 V / 0.625 A
Efficiency, End-to-End	$V_{IN} = 50$ V, Schottky bridge	71.2 %	77.7 %	85.9 %	89.3 %
Efficiency, End-to-End	$V_{IN} = 50$ V, Silicon bridge	70.8 %	77.1 %	85.3 %	88.6 %
Switching Frequency	R_{FREQ} (R10) = 88.7 kΩ	220 kHz			
Conducted EMI	EN55032, average detector	Passed			
Conducted EMI	EN55032, peak detector	Passed			
Radiated EMI	EN55032 Class B	Passed			

Table of Contents

1. Selector Guide	4
2. Powering Up the Si3404-Buck Board	5
3. Si3404-Buck EVB: 3.3 V, Class 2 Configuration	6
3.1 Si3404-Buck EVB Schematic: 3.3 V, Class 2, 7 W	6
3.2 End-to-End EVB Efficiency	7
3.3 Thermal Measurements	8
3.4 SIFOS PoE Compatibility Test Results	9
3.5 Adjustable EVB Current Limit	9
3.6 Feedback Loop Phase and Gain Measurement Results (Bode Plots)	10
3.7 Load Step Transient Measurement Results	11
3.8 Output Voltage Ripple	11
3.9 Soft-Start Protection	12
3.10 Output Short Protection	13
3.11 Pulse Skipping at No-Load Condition	14
3.12 Discontinuous (DCM) and Continuous (CCM) Current Modes	14
3.13 Radiated Emissions Measurement Results	15
3.14 Conducted Emissions Measurement Results	16
3.15 Bill of Materials	17
4. Si3404-Buck EVB: 5 V, Class 2 Configuration	19
4.1 Si3404-Buck EVB Schematic: 5V, Class 2, 7 W	19
4.2 End-to-End EVB Efficiency	20
4.3 Thermal Measurements	21
4.4 SIFOS PoE Compatibility Test Results	22
4.5 Adjustable EVB Current Limit	22
4.6 Feedback Loop Phase and Gain Measurement Results (Bode Plots)	23
4.7 Load Step Transient Measurement Results	24
4.8 Output Voltage Ripple	24
4.9 Soft-Start Protection	25
4.10 Output Short Protection	26
4.11 Pulse Skipping at No-Load Condition	27
4.12 Discontinuous (DCM) and Continuous (CCM) Current Modes	27
4.13 Radiated Emissions Measurement Results	28
4.14 Conducted Emissions Measurement Results	29
4.15 Bill of Materials	30
5. Si3404-Buck EVB: 12 V, Class 3 Configuration	32

5.1	Si3404-Buck EVB Schematic: 12 V Class 3, 15.4 W32
5.2	End-to-End EVB Efficiency33
5.3	Thermal Measurements34
5.4	SIFOS PoE Compatibility Test Results35
5.5	Adjustable EVB Current Limit35
5.6	Feedback Loop Phase and Gain Measurement Results (Bode Plots).36
5.7	Load Step Transient Measurement Results37
5.8	Output Voltage Ripple37
5.9	Soft-Start Protection38
5.10	Output Short Protection39
5.11	Pulse Skipping at No-Load Condition40
5.12	Discontinuous (DCM) and Continuous (CCM) Current Modes40
5.13	Radiated Emissions Measurement Results41
5.14	Conducted Emissions Measurement Results42
5.15	Bill of Materials43
6.	Si3404-Buck EVB: 24 V, Class 3 Configuration	45
6.1	Si3404-Buck EVB Schematic: 24V, Class 3, 15.4W45
6.2	End-to-End EVB Efficiency46
6.3	Thermal Measurements47
6.4	SIFOS PoE Compatibility Test Results48
6.5	Adjustable EVB Current Limit48
6.6	Feedback Loop Phase and Gain Measurement Results (Bode Plots).49
6.7	Load Step Transient Measurement Results50
6.8	Output Voltage Ripple51
6.9	Soft-Start Protection52
6.10	Output Short Protection53
6.11	Pulse Skipping at No-Load Condition54
6.12	Discontinuous (DCM) and Continuous (CCM) Current Modes55
6.13	Radiated Emissions Measurement Results56
6.14	Conducted Emissions Measurement Results57
6.15	Bill of Materials58
7.	Tunable Switching Frequency	60
8.	Board Layout	61
9.	Appendix—Si3404 Buck Design and Layout Checklist	63

1. Selector Guide

The minimum possible output voltage of this evaluation board is 3.3 V, the maximum possible output voltage is 24 V.

This user guide presents 4 different output voltages: 3.3 V, 5 V, 12 V and 24 V.

The efficiency and maximum power of the EVB highly depends on the output voltage. Higher output voltage configurations tend to have higher efficiency and output power capabilities, meanwhile, lower output voltage configurations have lower efficiency and output power.

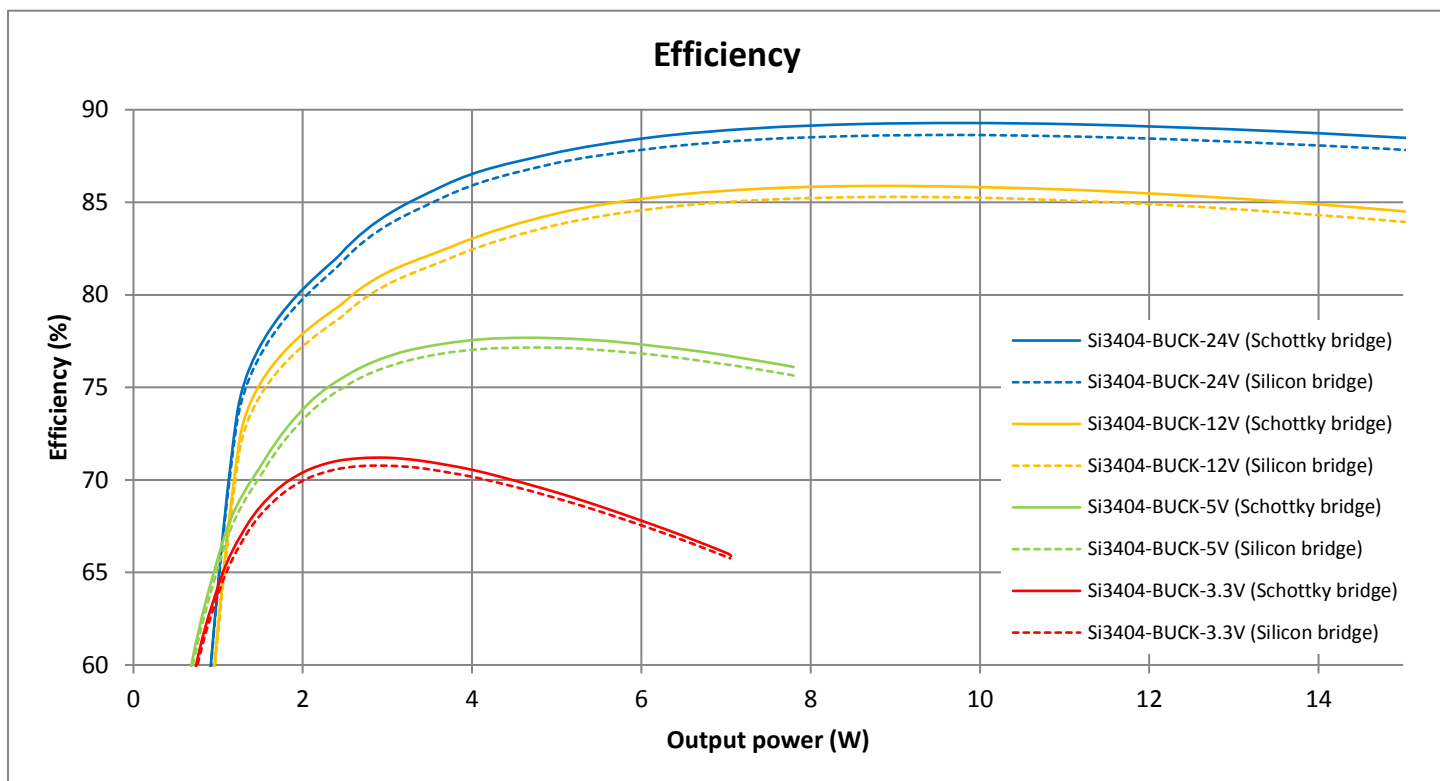

Figure 1.1. Si3404-Buck Non-Isolated EVB End-to-End Efficiency of Different Configurations: 50 V Input

Note: The chart shows the end-to-end EVB efficiency, where voltage drop on the diode bridge is included and LEDs are removed.

The standard Si3404-Buck EVB is shown on the cover page. This document includes complete schematics and measurement data for the following four different output voltages:

- Si3404-Buck-3.3V-7W – Class 2
- Si3404-Buck-5.0V-7W – Class 2
- Si3404-Buck-12V-15.4W – Class 3
- Si3404-Buck-24V-15.4W – Class 3

The parts in red on the schematics represent the BOM differences between the four designs.

The boards are shipped with silicon type diode bridges installed. If higher efficiency is needed, those S1B diodes can be replaced with Schottky type, for example SS2150 parts. See Figure 1.1 for overall conversion efficiency results.

When Schottky bridge is used, to compensate the reverse leakage of the Schottky type diode bridges at high temperature, the recommended detection resistor should be adjusted to the values listed in the following table:

Table 1.1. Recommended Detection Resistor Values

External Diode Bridge	R_{DET}
Silicon Type	24.3 k Ω
Schottky Type	24.9 k Ω

2. Powering Up the Si3404-Buck Board

Ethernet data and power are applied to the board through the RJ45 connector (J1). The board itself has no Ethernet data transmission functionality, but, as a convenience, the Ethernet transformer secondary-side data is brought out to test points.

The design can be used in Gigabit (10/100/1000) systems as well by using PoE RJ45 Magjack, such as type L8BE-1G1T-BFH from Bel Fuse.

Power may be applied in the following ways:

- Using any IEEE 802.3-2015-compliant, PoE-capable PSE or
- Using a laboratory power supply unit (PSU):
 - Connecting a dc source between blue/white-blue and brown/white-brown of the Ethernet cable (either polarity), (End-span) as shown below:

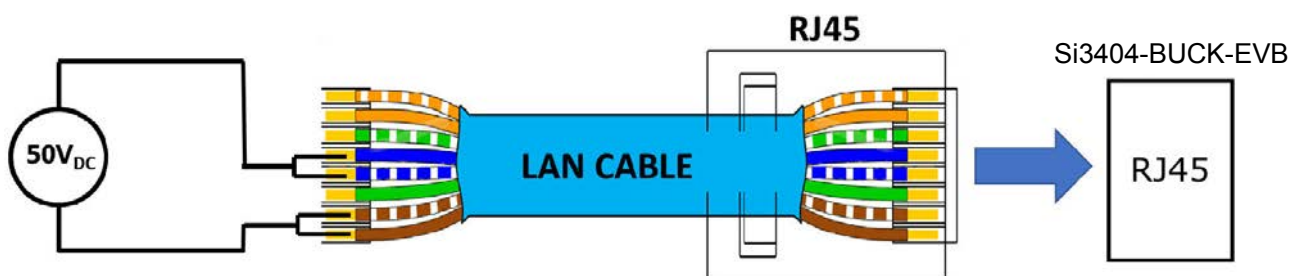

Figure 2.1. Endspan Connection using Laboratory Power Supply

- Connecting a dc source between green/white-green and orange/white-orange of the Ethernet cable (either polarity), (Mid-span) as shown below:

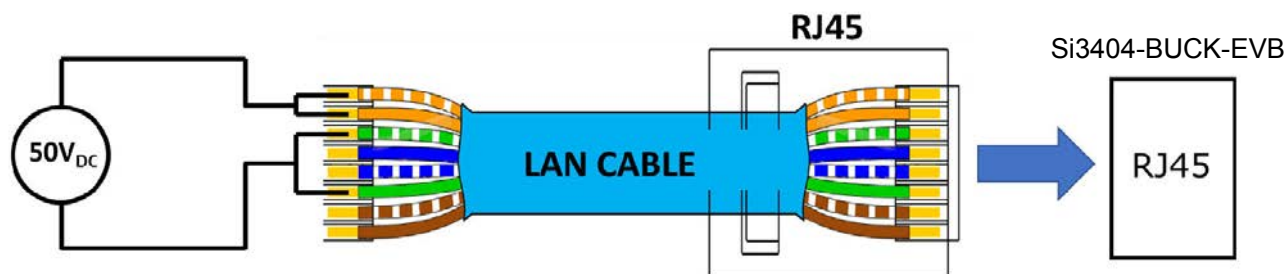
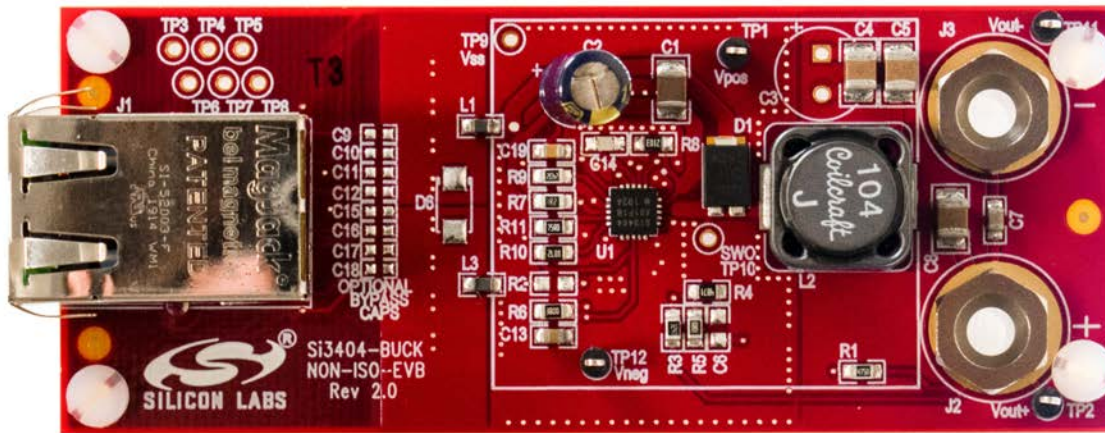

Figure 2.2. Midspan Connection using Laboratory Power Supply

3. Si3404-Buck EVB: 3.3 V, Class 2 Configuration



3.1 Si3404-Buck EVB Schematic: 3.3 V, Class 2, 7 W

In the figure below, the schematic of the Si3404-Buck 3.3V, Class 2 EVB is shown. The parts in red on the schematic represent the BOM differences compared to the core design.

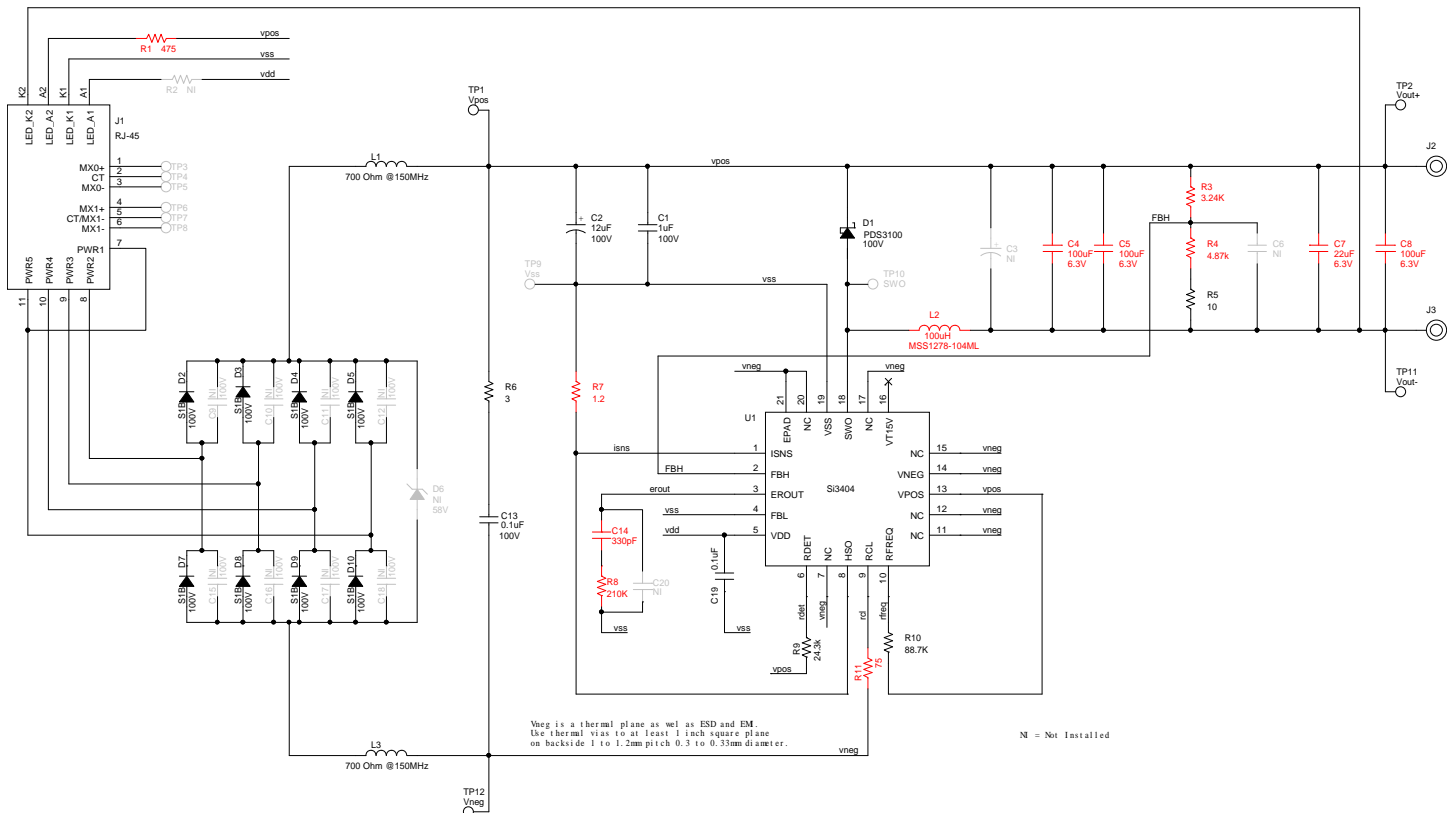

Figure 3.1. Si3404 Buck Non-Isolated EVB Schematic: 3.3 V, Class 2 PD, 7 W

3.2 End-to-End EVB Efficiency

The end-to-end conversion efficiency measurement data of the Si3404 3.3 V Buck board is shown below with silicon and Schottky type input bridges. The input voltage is 50 V in both cases.

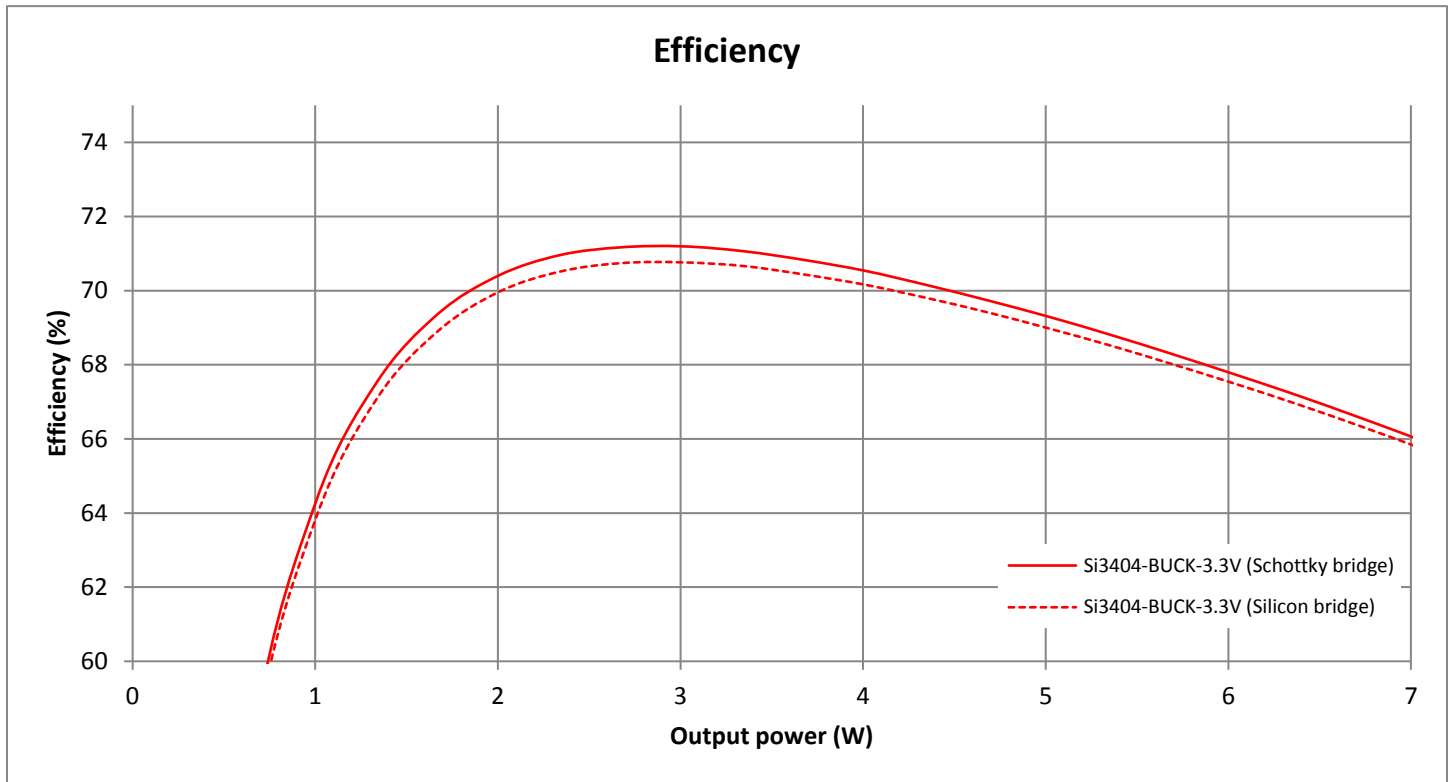

Figure 3.2. Si3404-Buck End-to-End Efficiency Chart with Silicon and Schottky Type Input Bridge Diodes: 50 V Input, 3.3 V Output, Class 2

Note: The chart shows end-to-end EVB efficiency. The voltage drop of the diode bridge is included. LEDs are removed.

3.3 Thermal Measurements

The Si3404-Buck EVB's temperature was measured at maximum **output power – 6.5 W**. The Si3404-Buck EVB is configured for 3.3 V output voltage and Class 2 power level. The following figure shows the thermal images taken of the EVB board at maximum output power.

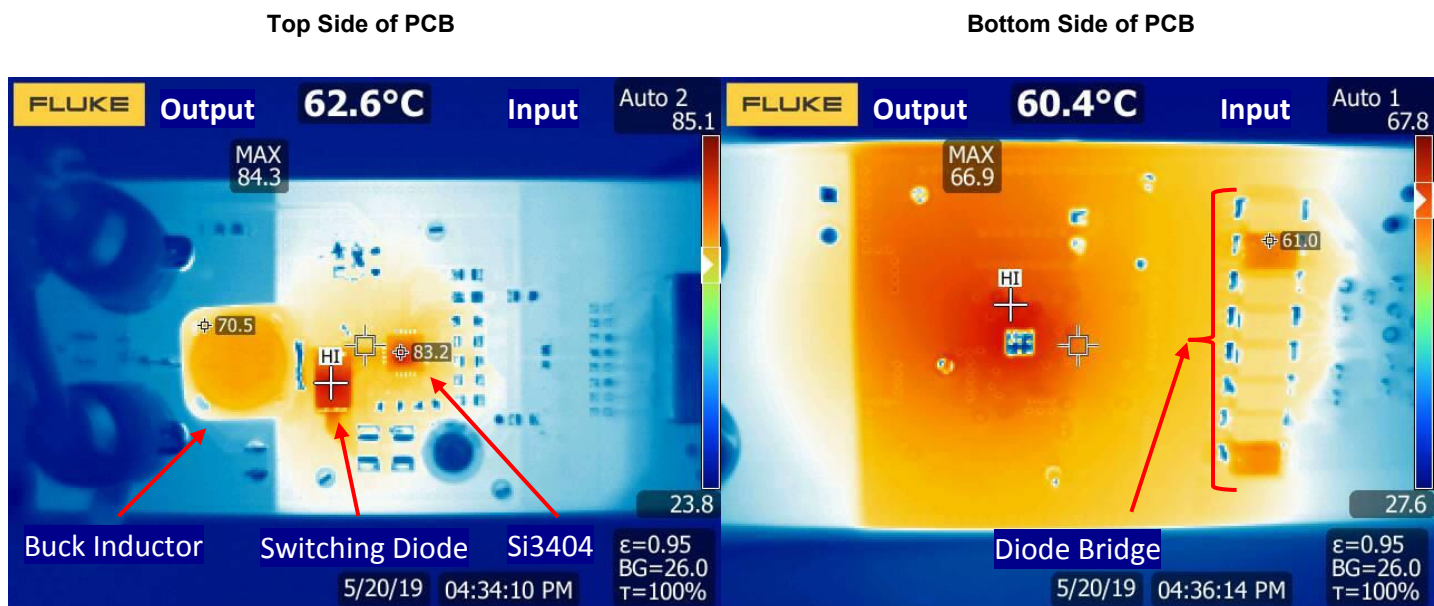

Figure 3.3. Thermal Measurements of the Si3404-Buck Non-Isolated EVB, 3.3 V, Class 2 PD

The following table lists the temperatures of the notable components across the board.

Table 3.1. Component Temperatures at Full Load

Component	Temperature
Si3404 – U1	83.2 °C
Switching Diode – D1	84.3 °C
Buck Inductor – L2	70.5 °C
Diode Bridge – D2-D5, D7-D10	61.0 °C

Note: The ambient temperature was 26 °C during the thermal measurements.

3.4 SIFOS PoE Compatibility Test Results

The PDA-300 Powered Device Analyzer is a single-box comprehensive solution for testing IEEE 802.3at PoE Powered Devices (PDs). The Si3404-Buck EVB board has been successfully tested with the PDA-300 Powered Device Analyzer from SIFOS Technologies.

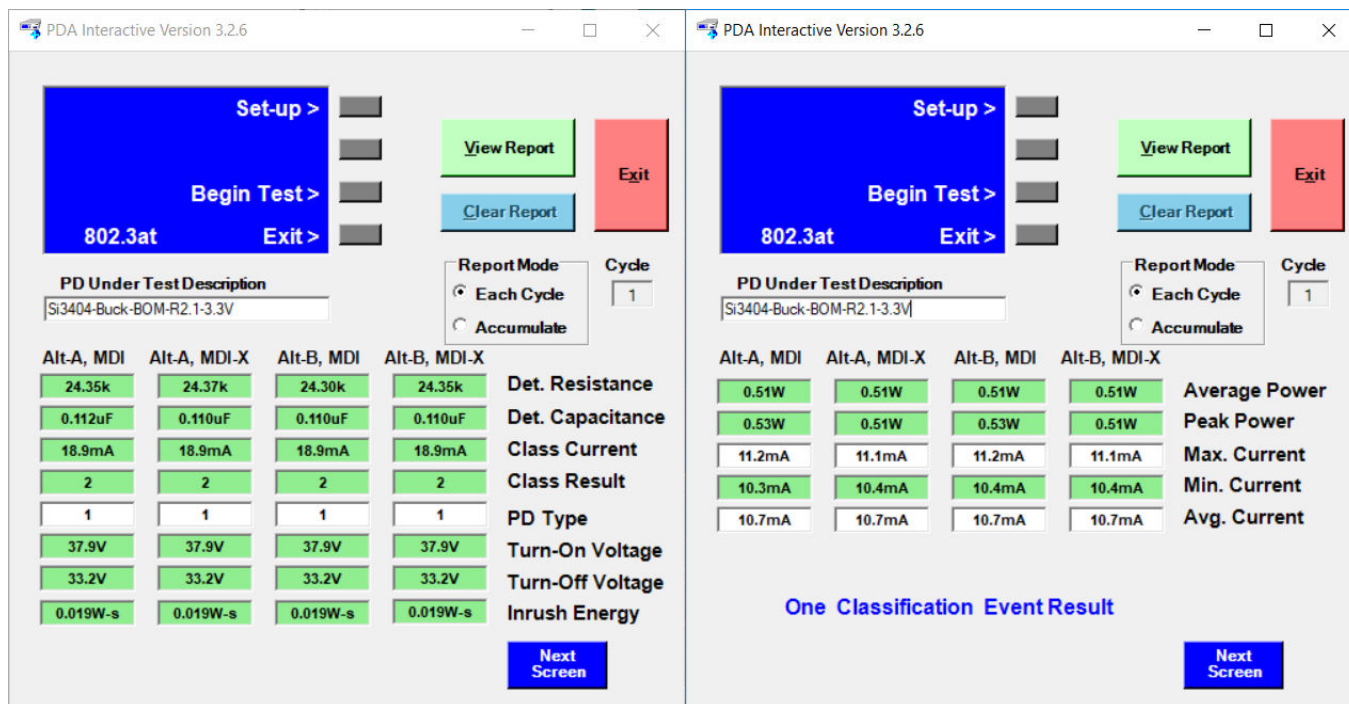

Figure 3.4. Si3404-Buck Non-Isolated EVB, 3.3 V, Class 2 PD SIFOS PoE Compatibility Test Results

3.5 Adjustable EVB Current Limit

For additional safety, the Si3404 has an adjustable EVB current limit feature.

The Si3404 controller measures the voltage on the R_{SENSE} resistor (R7) through the ISNS pin. Attention must be paid, that this voltage goes below V_{SS} . When the voltage on the R7 is $V_{ISNS} = -270\text{ mV}$ (referenced to V_{SS}), the internal current limit circuit restarts the PD to protect the application.

The EVB current limit for this Class 2 application can be calculated with the following formula:

$$R_{SENSE} = 1.2\Omega$$

$$I_{LIMIT} = \frac{270\text{mV}}{1.2\Omega} = 225\text{mA}$$

Equation 3.1. EVB Class 2 Current Limit

3.6 Feedback Loop Phase and Gain Measurement Results (Bode Plots)

The Si3404 device integrates a current-mode-controlled switching mode power supply controller circuit. Therefore, the application is a closed-loop system. To guarantee stable output voltage of the power supply and to reduce the influence of the input voltage variations and load changes on the output voltage, the feedback loop should be stable.

To verify the stability of the loop, the loop gain and loop phase shift have been measured.

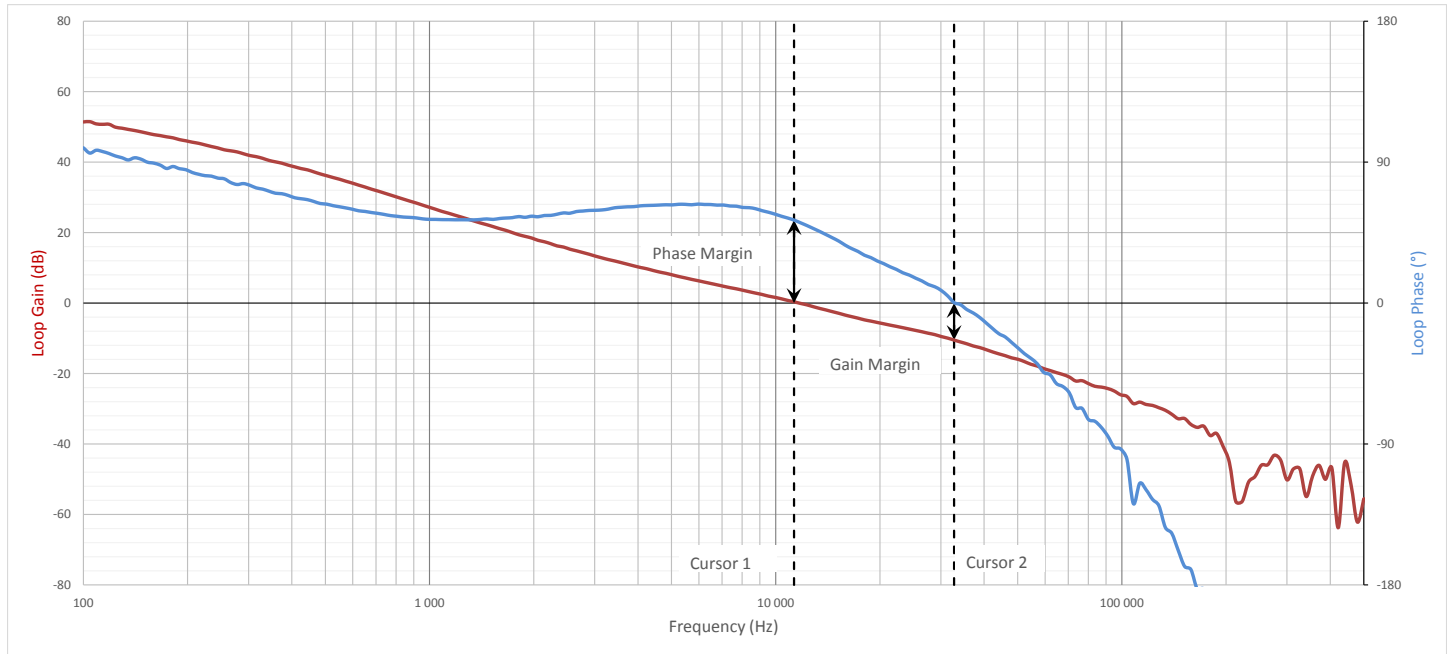

Figure 3.5. Si3404-Buck Non-Isolated EVB, 3.3 V, Class 2 PD Feedback Loop Measurement Results at Full Load

Table 3.2. Measured Loop Gain and Phase Margins

	Frequency	Gain	Phase
Cursor 1 (Phase Margin)	11.7 kHz	0 dB	51 °
Cursor 2 (Gain Margin)	33.1 kHz	-10.6 dB	0 °

3.7 Load Step Transient Measurement Results

The Si3404-Buck EVB board's output has been tested with a load step function to verify the converter's output dynamic response.

Load Step: from 0.2 to 1.8 A Output Current:
 $\Delta V_{OUT} = 136 \text{ mV}$

Load Step: from 1.8 to 0.2 A Output Current:
 $\Delta V_{OUT} = 264 \text{ mV}$

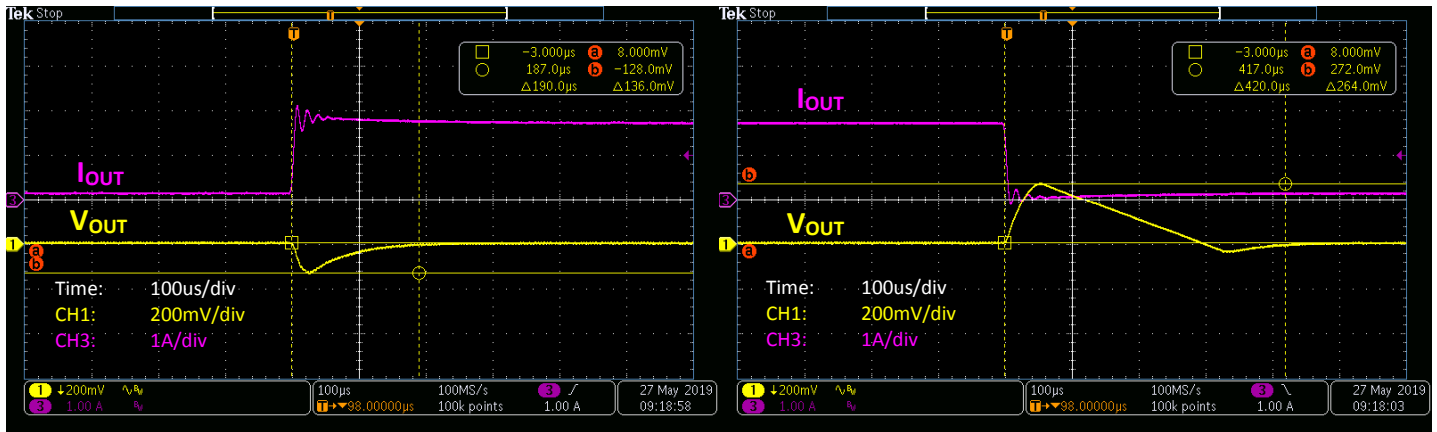

Figure 3.6. Si3404-Buck Non-Isolated EVB, 3.3 V, Class 2 PD Output Load Step Transient Test

3.8 Output Voltage Ripple

The Si3404-Buck EVB output voltage ripple has been measured in both no load and heavy load conditions.

No-Load V_{OUT} Ripple = 8.56 mV

Heavy-Load V_{OUT} Ripple = 5.76 mV

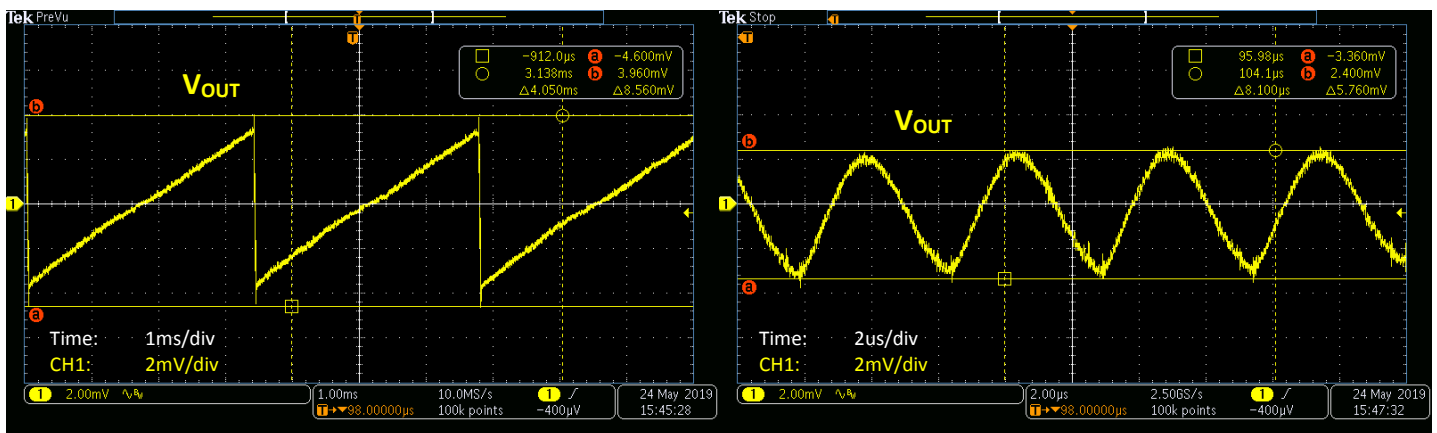

Figure 3.7. Si3404-Buck Non-Isolated EVB, 3.3 V, Class 2 Output Voltage Ripple No Load (Left) and Heavy Load (Right) Conditions

3.9 Soft-Start Protection

The Si3404 device has an integrated dynamic soft-start protection mechanism to avoid stressing the components by the sudden current or voltage changes associated with the initial charging of the output capacitors.

The Si3404 intelligent adaptive soft-start mechanism does not require any external component to install. The controller continuously measures the input current of the PD and dynamically adjusts the internal IPEAK limit during soft-start, that way adjusting the output voltage ramping up time in a function of the attached load.

The controller lets the output voltage to rise faster in no load (or light load) condition. With heavy load at the output, the controller slows down the output voltage ramp to avoid exceeding the desired regulated output voltage value.

No-Load Soft Start:
 $t_{RISE} = 6.1 \text{ ms}$

Heavy-Load Soft Start:
 $t_{RISE} = 85.4 \text{ ms}$

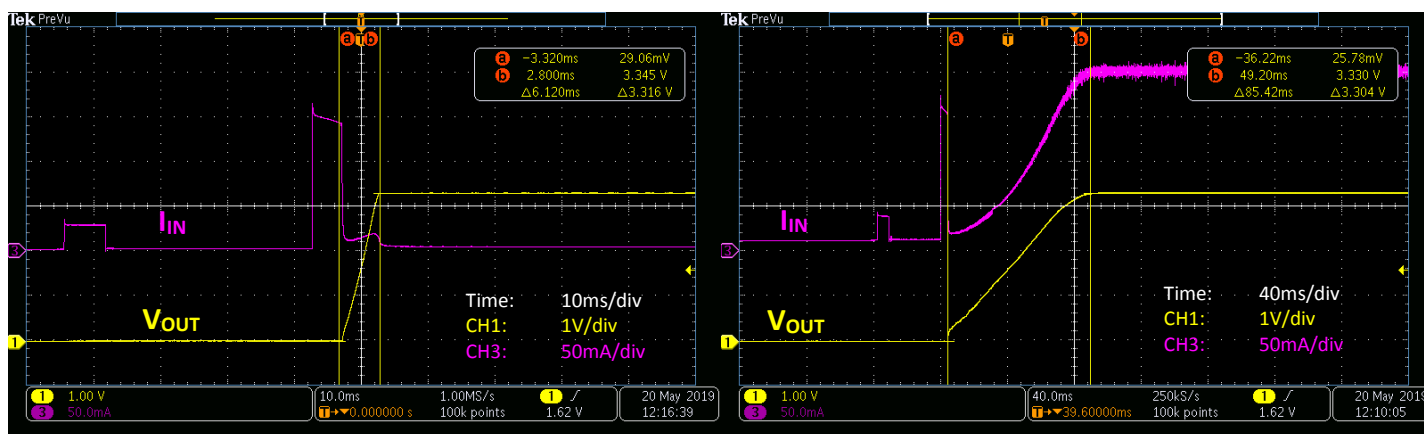

Figure 3.8. Si3404-Buck Non-Isolated EVB, 3.3 V, Class 2 Output Voltage Soft-Start at Low Load (Left) and Heavy Load (Right) Conditions

3.10 Output Short Protection

The Si3404 device has an integrated output short protection mechanism, which protects the IC itself and the surrounding external components from overheating in the case of electrical short on the output.

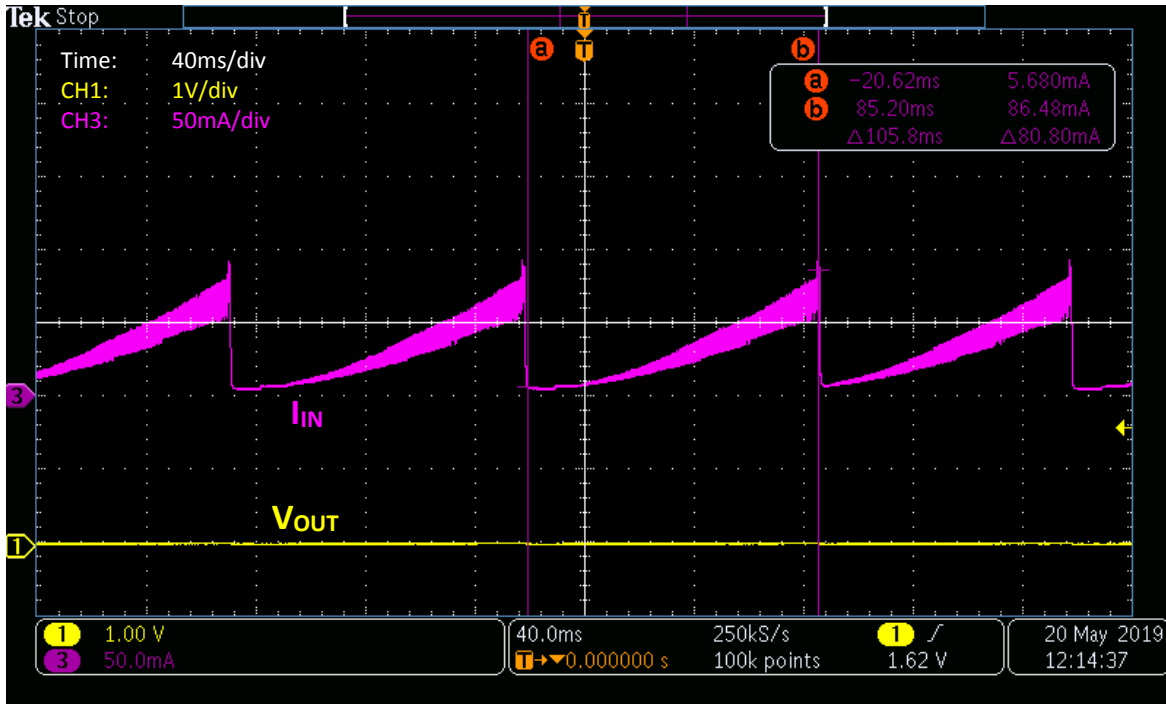

Figure 3.9. Si3404-Buck Non-Isolated EVB, 3.3 V, Class 2 Output Short Circuit Protection

3.11 Pulse Skipping at No-Load Condition

The Si3404 device has an integrated pulse skipping mechanism to ensure ultra-low power consumption at light load condition.

As the output load decreases, the controller starts to reduce the pulse-width of the PWM signal (switcher ON time). At some point, even the minimum width pulse would provide higher energy than the application requires, which could result in loss of voltage regulation.

When the controller detects light load condition (which requires less ON time than the minimum pulse width), the controller enters into burst or light-load skipping mode. This mode is shown on Figure 3.10 by depicting the switching node of the integrated switching FET at no load condition.

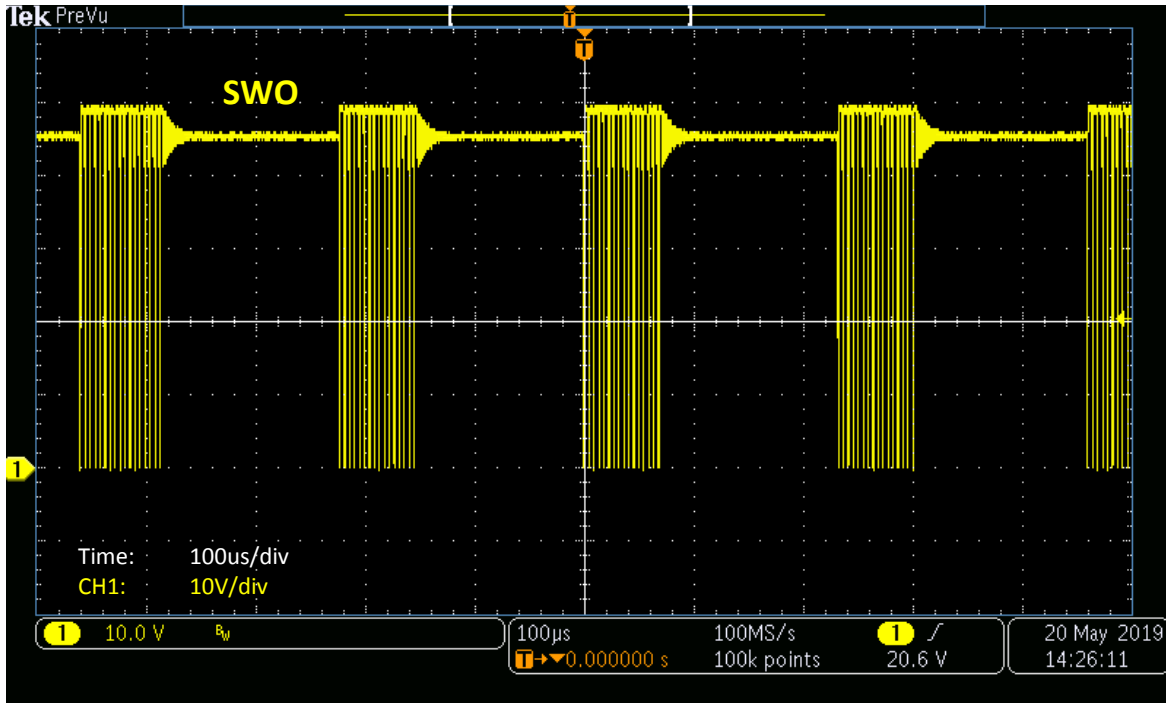

Figure 3.10. Si3404-Buck Non-Isolated EVB, 3.3 V, Class 2 Pulse Skipping at No-load Condition: SWO Waveform

3.12 Discontinuous (DCM) and Continuous (CCM) Current Modes

At low-load the converter works in discontinuous current mode (DCM), at heavy load the converter runs in continuous current mode (CCM). At low-load the SWO voltage waveform has a ringing waveform, which is typical for a DCM operation.

Low-Load, DCM

Heavy-Load, CCM

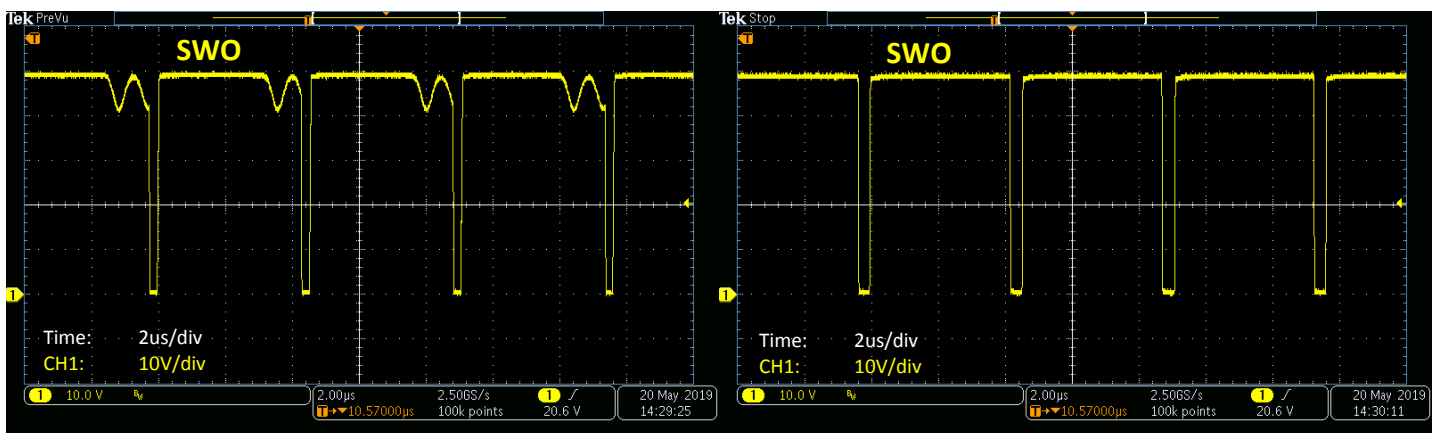

Figure 3.11. Si3404-Buck Non-Isolated EVB, 3.3 V, Class 2: SWO Waveform in Discontinuous Current Mode (DCM) at Low Load (Left), and in Continuous Current Mode (CCM) at Heavy Load (Right)

3.13 Radiated Emissions Measurement Results

Radiated emissions have been measured of the Si3404-Buck, 3.3 V, Class 2 EVB board with 50 V input voltage and full load connected to the output – 6.5 W.

As shown in the following figure, the Si3404-Buck, 3.3 V, Class 2 EVB is fully compliant with the international EN 55032 class B emissions standard.

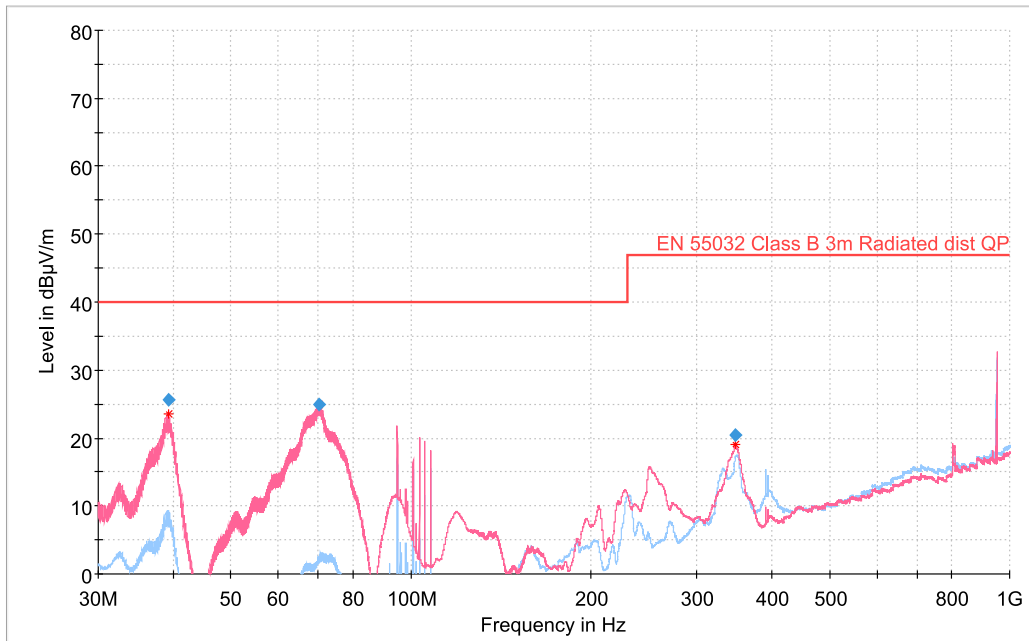

Figure 3.12. Si3404-Buck Non-Isolated EVB Radiated Emissions Measurements Results; 50 V Input, 3.3 V Output, 6.5 W Output Load

The EVB is measured at full load with peak detection in both vertical and horizontal polarizations. This is a relatively fast process that produces a red curve (vertical polarization) and a blue curve (horizontal polarization). Next, specific frequencies are selected (red stars) for quasi-peak measurements. The board is measured again at those specific frequencies with a quasi-peak detector, which is a very slow but accurate measurement. The results of this quasi-peak detector measurement are the blue rhombuses.

The blue rhombuses represent the final result of the measurement process. To have passing results, the blue rhombuses should be below the highlighted EN 55032 Class B limit.

3.14 Conducted Emissions Measurement Results

The Si3404-Buck, 3.3 V, Class 2 EVB board's conducted emissions have been measured in two different measurement methods to comply with the international EN 55032 standard. The EVB is supplied and measured on its PoE input port as shown in the following figure.

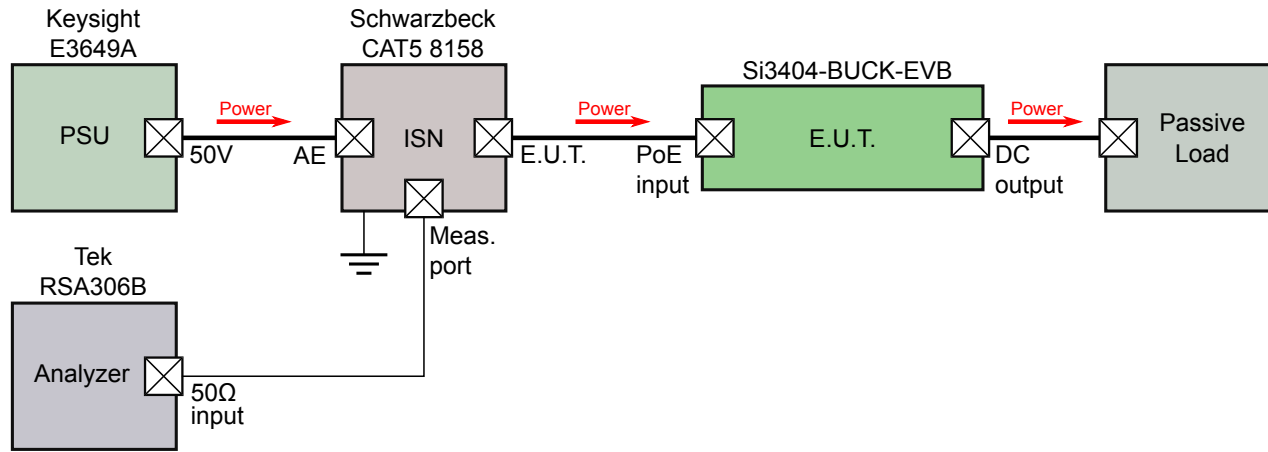

Figure 3.13. Conducted EMI Measurement Setup

The detector in the spectrum analyzer is set to:

- Peak detector and
- Average detector

Both results are shown in the following figure.

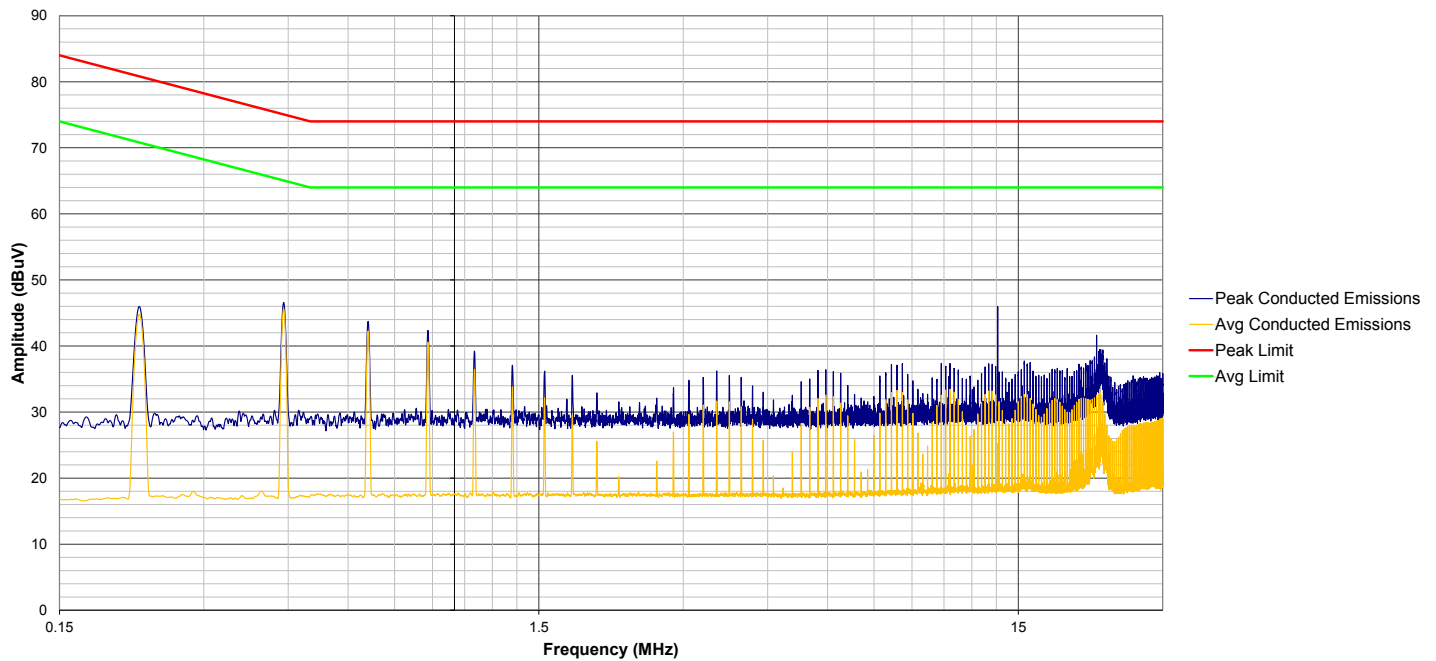

Figure 3.14. Si3404-Buck Non-Isolated EVB Conducted Emissions Measurements Results; 50 V Input, 3.3 V Output, 6.5 W Output Load

3.15 Bill of Materials

The following table is the BOM listing for the standard 3.3 V output evaluation board with option PoE Class 2.

Table 3.3. Si3404-Buck 3.3 V Bill of Materials

Designator	Quantity	Description	Manufacturer	Manufacturer Part Number
C1	1	CAP, 1 μ F, 100 V, \pm 10%, X7R, 1210	Venkel	C1210X7R101-105K
C13	1	CAP, 0.1 μ F, 100 V, \pm 10%, X7R, 0805	Venkel	C0805X7R101-104K
C14	1	CAP, 330 pF, 50 V, \pm 1%, C0G, 0805	Venkel	C0805C0G500-331F
C19	1	CAP, 0.1 μ F, 16 V, \pm 10%, X7R, 0805	Venkel	C0805X7R160-104K
C2	1	CAP, 12 μ F, 100 V, \pm 20%, AL, 6.3X11.2MM	Panasonic	EEUFC2A120
C4, C5, C8	3	CAP, 100 μ F, 6.3 V, \pm 10%, X5R, 1210	Venkel	C1210X5R6R3-107K
C7	1	CAP, 22 μ F, 6.3 V, \pm 20%, X5R, 0805	Venkel	C0805X5R6R3-226M
D1	1	DIO, Schottky, 100 V, 3 A, PowerDI-5	Diodes Inc.	PDS3100-13
D2, D3, D4, D5, D7, D8, D9, D10	8	DIO, Single, 100 V, 1.0 A, SMA	Fairchild	S1B
J1	1	CONN, RJ-45, Magjack, 1 Port PoE	Bel	SI-52003-F
J2, J3	2	CONN, Banana Jack, Threaded uninsulated	Abbatron HH Smith	101
L1, L3	2	Ferrite Bead, 700 Ω @150 MHz, 0805	Würth	742792040
L2	1	Inductor, Power, Shielded, 100 μ H, \pm 20%, 2.88 A, SMD	Coilcraft	MSS1278-104ML
R1	1	RES, 475 Ω , 1/8 W, \pm 1%, ThickFilm, 0805	Venkel	CR0805-8W-4750FT
R10	1	RES, 88.7 k Ω , 1/8 W, \pm 1%, ThickFilm, 0805	Vishay	CRCW080588K7FKEA
R11	1	RES, 75 Ω , 1/10 W, \pm 1%, ThickFilm, 0805	Venkel	CR0805-10W-75R0F
R3	1	RES, 3.24 k Ω , 1/8 W, \pm 1%, ThickFilm, 0805	Vishay	CRCW08053K24FKEA
R4	1	RES, 4.87 k Ω , 1/8 W, \pm 1%, ThickFilm, 0805	Yageo	RC0805FR-074K87L
R5	1	RES, 10 Ω , 1/10 W, \pm 1%, ThickFilm, 0805	Venkel	CR0805-10W-10R0F
R6	1	RES, 3 Ω , 1/8 W, \pm 1%, ThickFilm, 0805	Venkel	CR0805-8W-3R00FT
R7	1	RES, 1.2 Ω , 1/10 W, \pm 5%, ThickFilm, 0805	Venkel	CR0805-10W-1R2J

Designator	Quantity	Description	Manufacturer	Manufacturer Part Number
R8	1	RES, 210 k Ω , 1/10 W, \pm 1%, ThickFilm, 0805	Venkel	CR0805-10W-2103F
R9	1	RES, 24.3 k Ω , 1/8 W, \pm 1%, ThickFilm, 0805	Vishay	CRCW080524K3FKEA
TP1, TP2, TP11, TP12	4	Testpoint, Black, 0.050" Loop, PTH	Keystone	5001
U1	1	IC, Fully-Integrated 802.3-Compliant PoE PD Interface and Low-EMI Switching Regulator, QFN20	Silicon Labs	Si3404-A-GM
Not-Installed Components				
C20	1	CAP, 330 pF, 50 V, \pm 1%, COG, 0805	Venkel	C0805C0G500-331F
C3	1	CAP, 6.3 V, \pm 20%, AL, 8.0 x 11.5 mm		
C6	1	CAP, 50 V, \pm 10%, X7R, 0805		
C9, C10, C11, C12, C15, C16, C17, C18	8	CAP, 1 nF, 100 V, \pm 10%, X7R, 0603	Venkel	C0603X7R101-102K
D6	1	DIO, TVS, UNIDIR, 58 V, 400 W	Littelfuse	SMAJ58A
R2	1	RES, 1 k Ω , 1/10 W, \pm 1%, ThickFilm, 0805	Venkel	CR0805-10W-1001F
TP3, TP4, TP5, TP6, TP7, TP8, TP9, TP10	8	Testpoint, Black, 0.050" Loop, PTH	Keystone	5001

4. Si3404-Buck EVB: 5 V, Class 2 Configuration

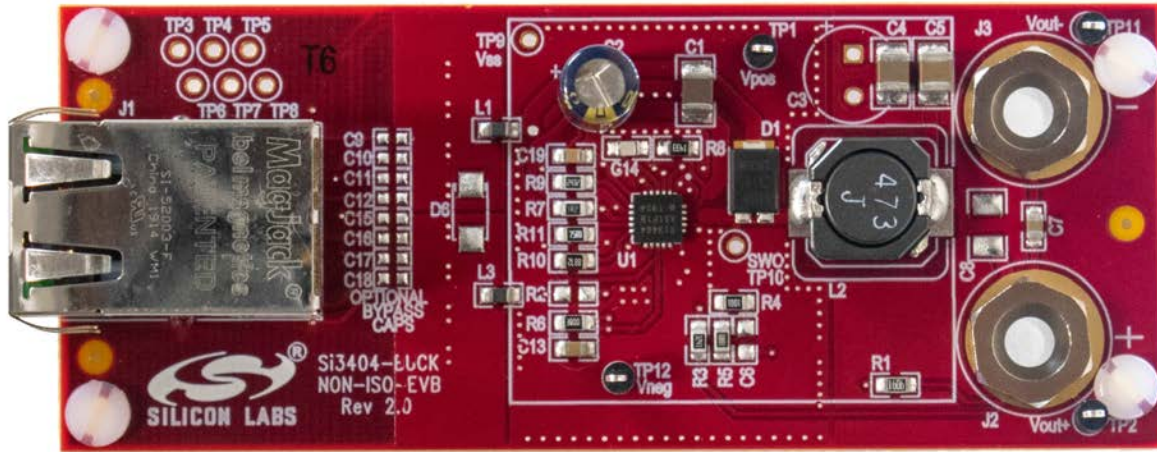

4.1 Si3404-Buck EVB Schematic: 5V, Class 2, 7 W

In the figure below, the schematic of the Si3404-Buck 5V, Class 2 EVB is shown. The parts in red on the schematic represent the BOM differences compared to the core design.

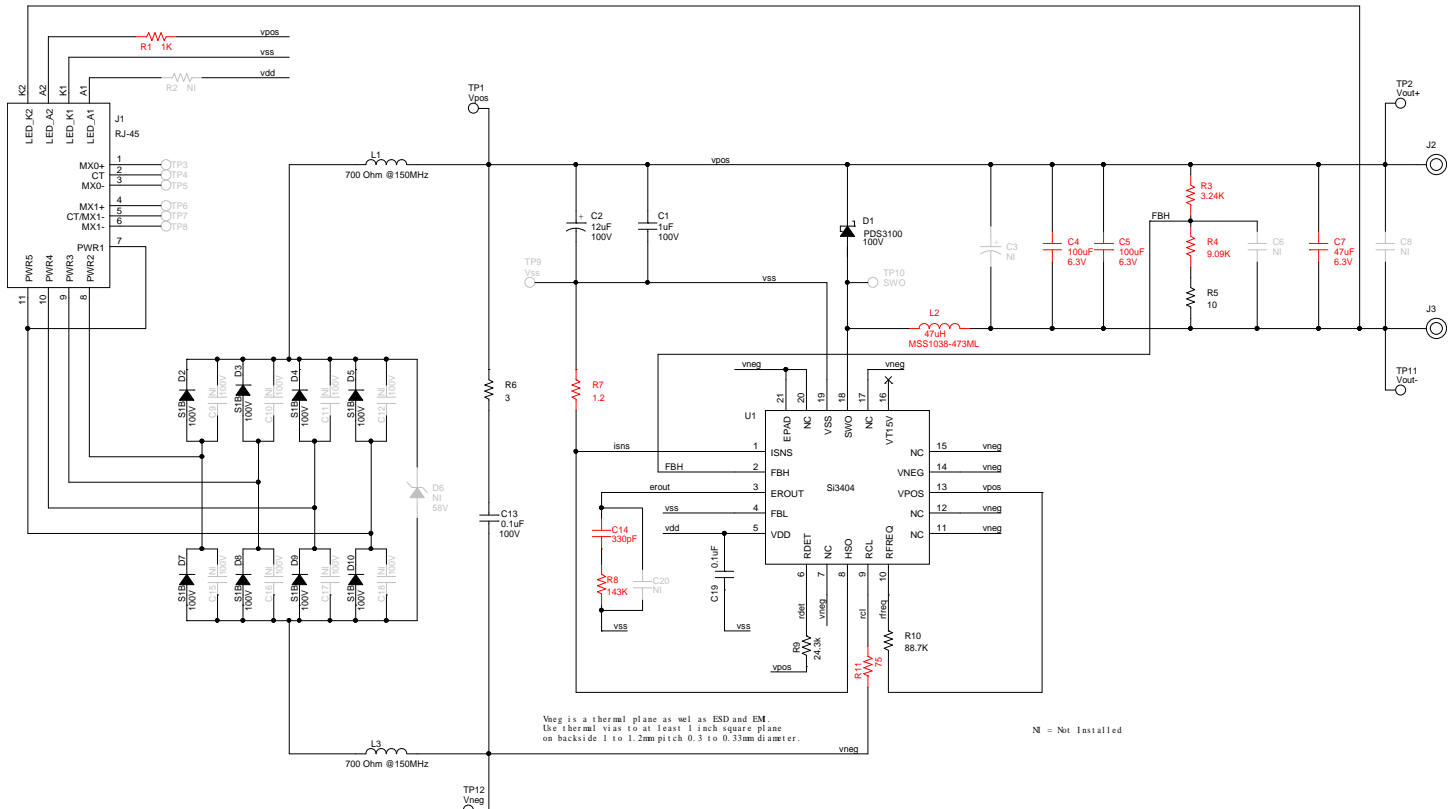

Figure 4.1. Si3404 Buck Non-Isolated EVB Schematic: 5 V, Class 2 PD, 7 W

4.2 End-to-End EVB Efficiency

The end-to-end conversion efficiency measurement data of the Si3404 5 V Buck board is shown below with silicon and Schottky type input bridges. The input voltage is 50 V in both cases.

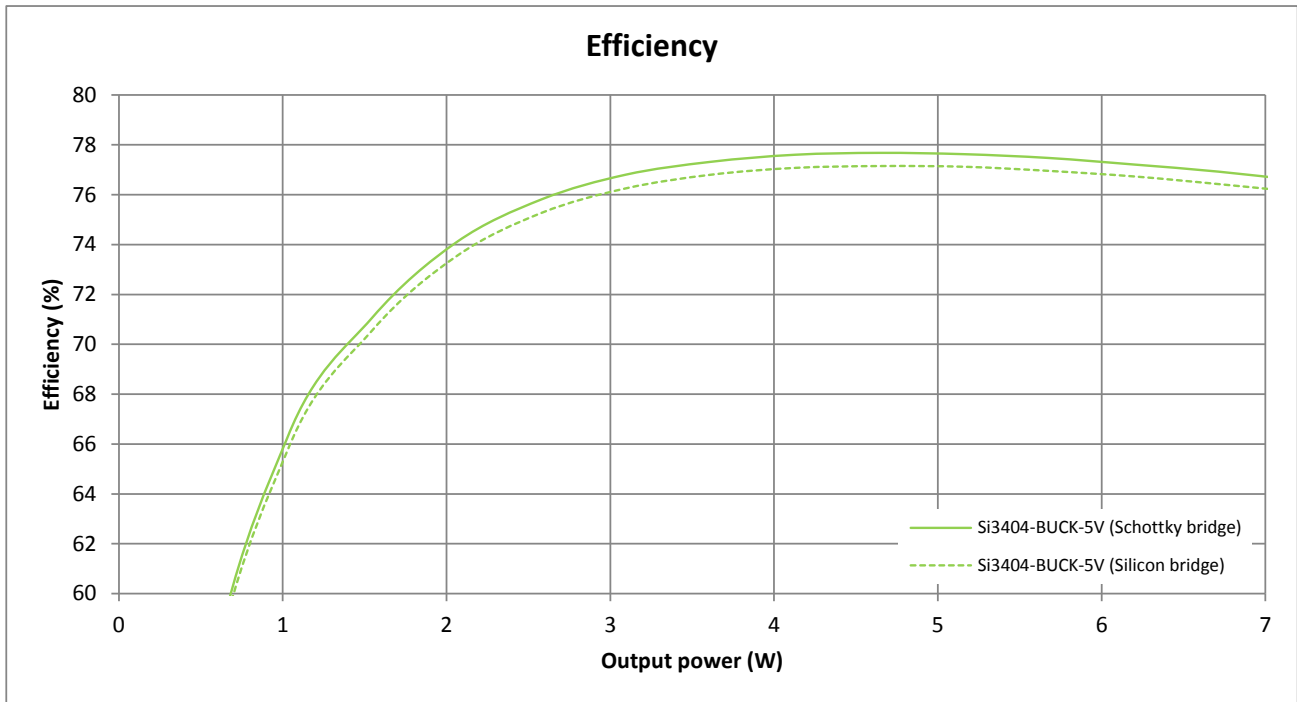

Figure 4.2. Si3404-Buck End-to-End Efficiency Chart with Silicon and Schottky Type Input Bridge Diodes: 50 V Input, 5 V Output, Class 2

Note: The chart shows end-to-end EVB efficiency. The voltage drop of the diode bridge is included. LEDs are removed.

4.3 Thermal Measurements

The Si3404-Buck EVB's temperature was measured at maximum **output power – 6.5 W**. The Si3404-Buck EVB is configured for 5 V output voltage and Class 2 power level. The following shows the thermal images taken of the EVB board at maximum output power

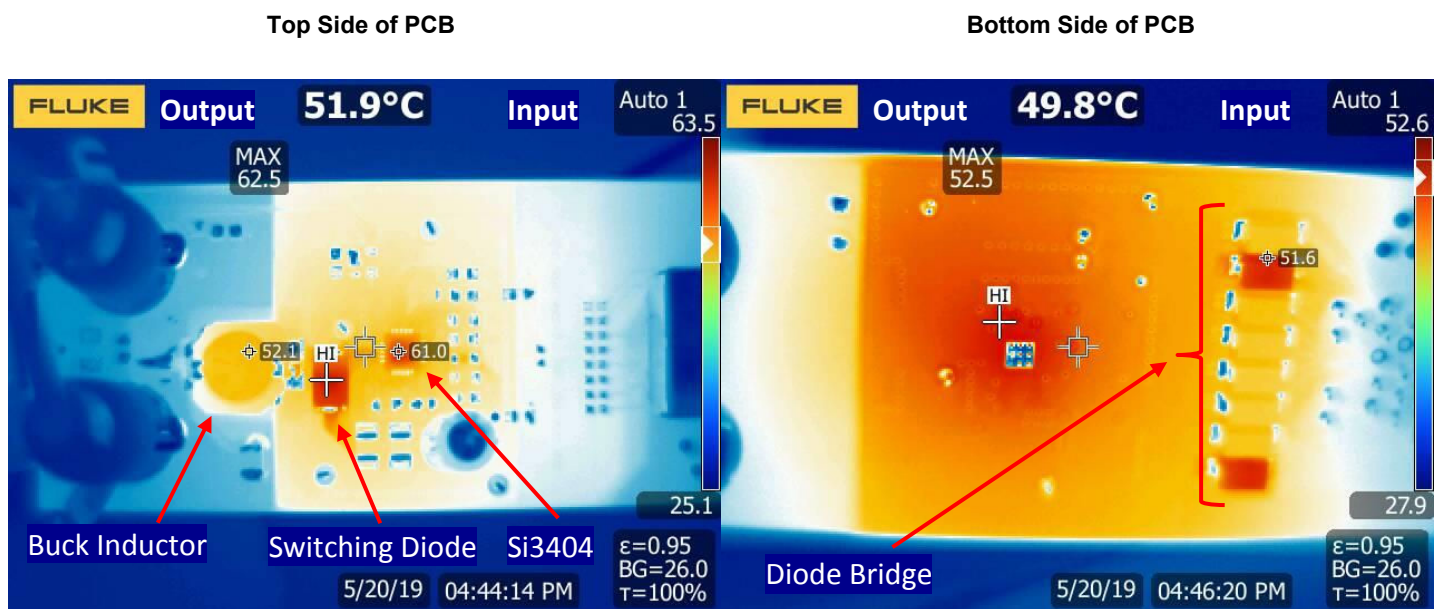

Figure 4.3. Thermal Measurements of the Si3404-Buck Non-Isolated EVB, 5 V, Class 2 PD

The following table lists the temperatures of the notable components across the board.

Table 4.1. Component Temperatures at Full Load

Component	Temperature
Si3404 – U1	61.0 °C
Switching Diode – D1	62.5 °C
Buck Inductor – L2	52.1 °C
Diode Bridge – D2-D5, D7-D10	51.6 °C

Note: The ambient temperature was 26 °C during the thermal measurements.

4.4 SIFOS PoE Compatibility Test Results

The PDA-300 Powered Device Analyzer is a single-box comprehensive solution for testing IEEE 802.3at PoE Powered Devices (PDs). The Si3404-Buck EVB board has been successfully tested with the PDA-300 Powered Device Analyzer from SIFOS Technologies.

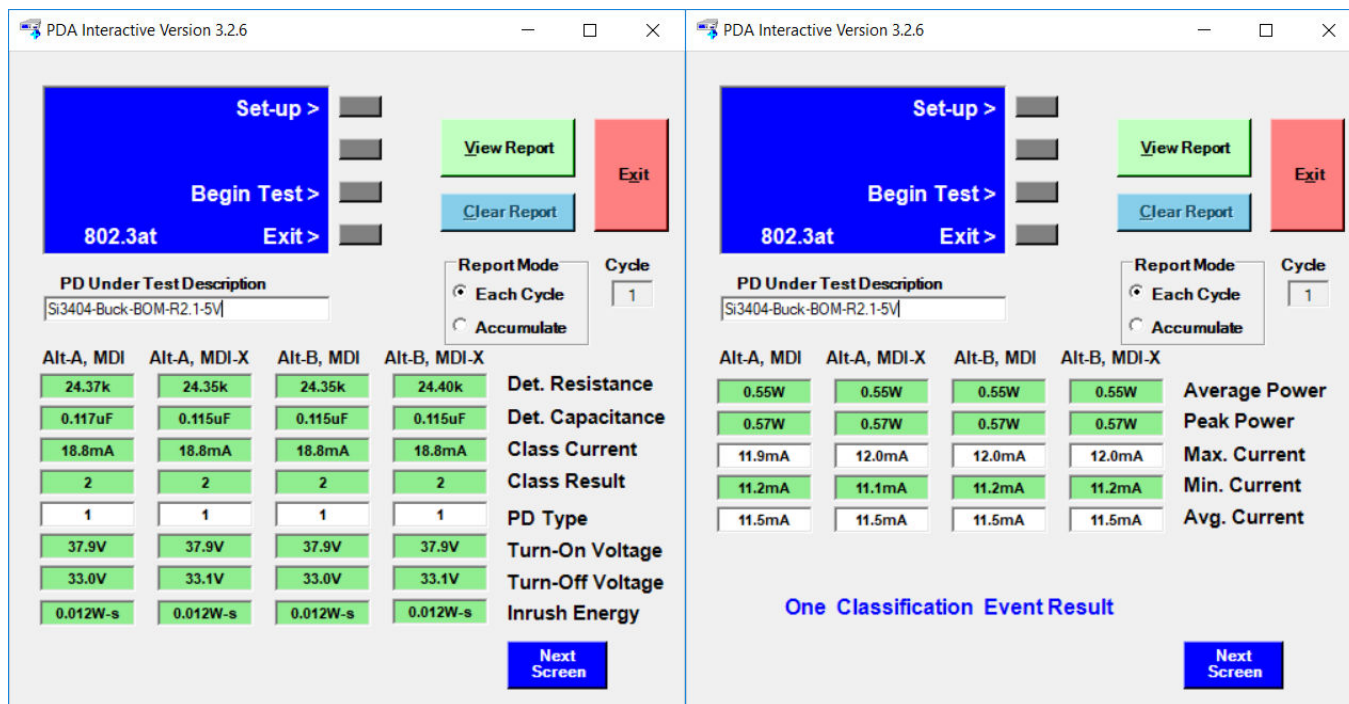

Figure 4.4. Si3404-Buck Non-Isolated EVB, 5 V, Class 2 PD SIFOS PoE Compatibility Test Results

4.5 Adjustable EVB Current Limit

For additional safety, the Si3404 has an adjustable EVB current limit feature.

The Si3404 controller measures the voltage on the R_{SENSE} resistor (R7) through the ISNS pin. Attention must be paid, that this voltage goes below V_{SS} . When the voltage on the R7 is $V_{ISNS} = -270$ mV (referenced to V_{SS}), the internal current limit circuit restarts the PD to protect the application.

The EVB current limit for this Class 2 application can be calculated with the following formula:

$$R_{SENSE} = 1.2\Omega$$

$$I_{LIMIT} = \frac{270mV}{1.2\Omega} = 225mA$$

Equation 4.1. EVB Class 2 Current Limit

4.6 Feedback Loop Phase and Gain Measurement Results (Bode Plots)

The Si3404 device integrates a current-mode-controlled switching mode power supply controller circuit. Therefore, the application is a closed-loop system. To guarantee stable output voltage of the power supply and to reduce the influence of the input voltage variations and load changes on the output voltage, the feedback loop should be stable.

To verify the stability of the loop, the loop gain and loop phase shift have been measured.

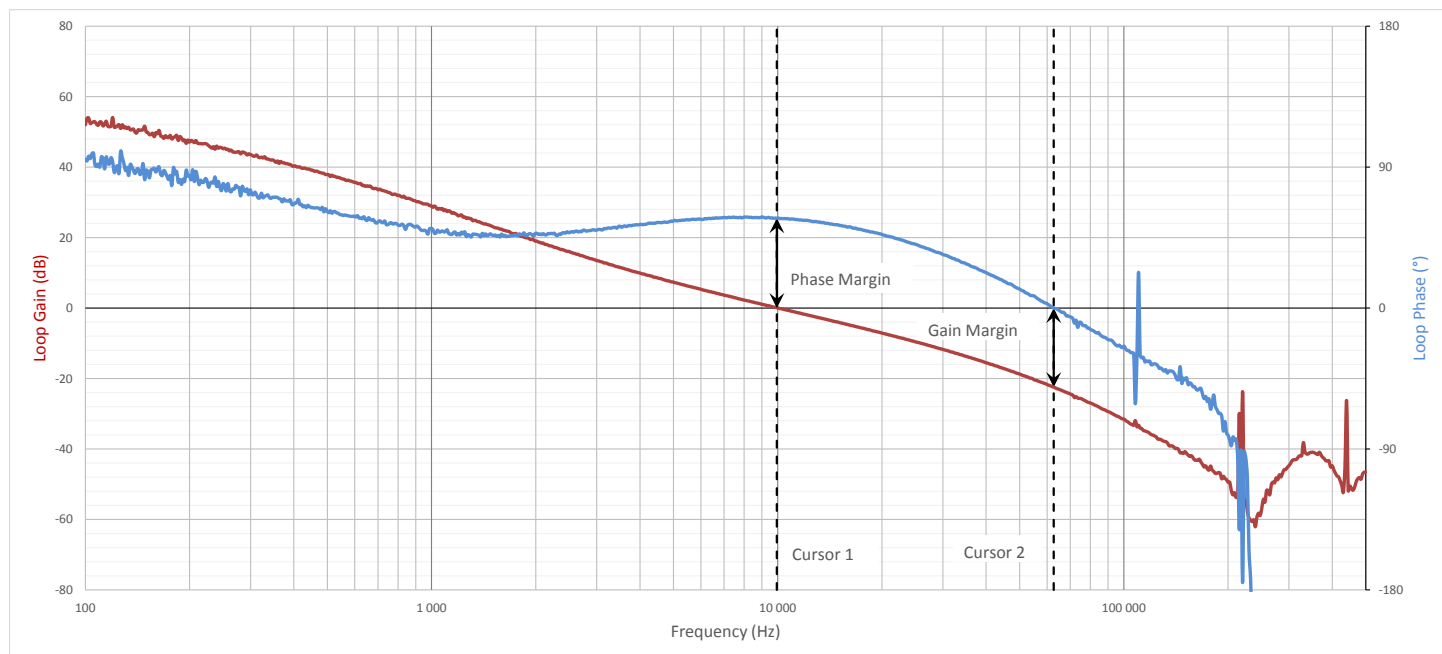

Figure 4.5. Si3404-Buck Non-Isolated EVB, 5 V, Class 2 PD Feedback Loop Measurement Results at Full Load

Table 4.2. Measured Loop Gain and Phase Margins

	Frequency	Gain	Phase
Cursor 1 (Phase Margin)	10 kHz	0 dB	57 °
Cursor 2 (Gain Margin)	62.7 kHz	-22.4 dB	0 °

4.7 Load Step Transient Measurement Results

The Si3404-Buck EVB board's output has been tested with a load step function to verify the converter's output dynamic response.

Load Step: from 0.1 to 1.2 A Output Current:
 $\Delta V_{OUT} = 176 \text{ mV}$

Load Step: from 1.2 to 0.1 A Output Current:
 $\Delta V_{OUT} = 168 \text{ mV}$

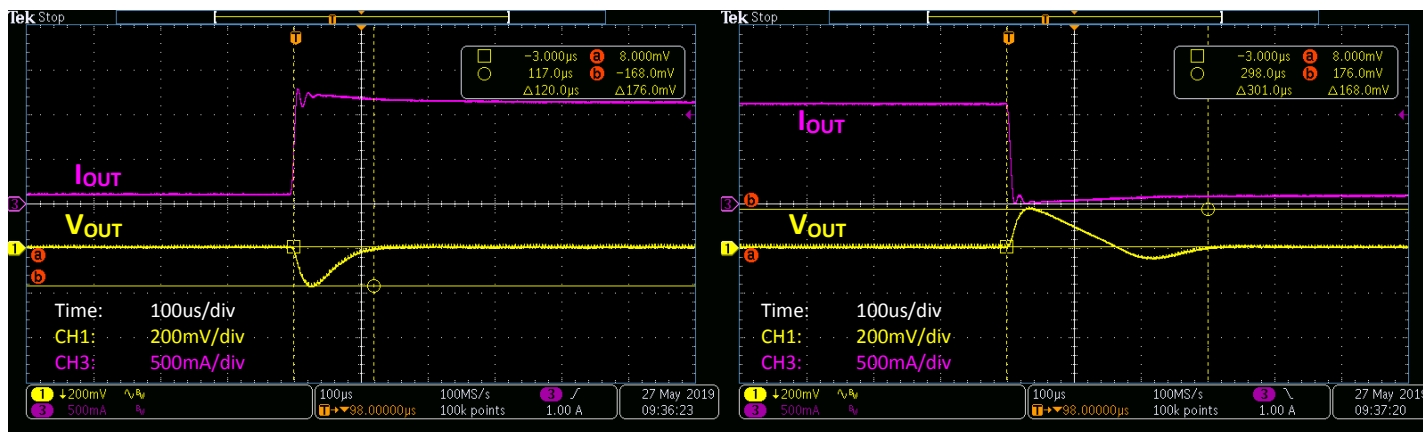

Figure 4.6. Si3404-Buck Non-Isolated EVB, 5 V, Class 2 PD Output Load Step Transient Test

4.8 Output Voltage Ripple

The Si3404-Buck EVB output voltage ripple has been measured in both no load and heavy load conditions.

No-Load V_{OUT} Ripple = 16 mV

Heavy-Load V_{OUT} Ripple = 14.4 mV

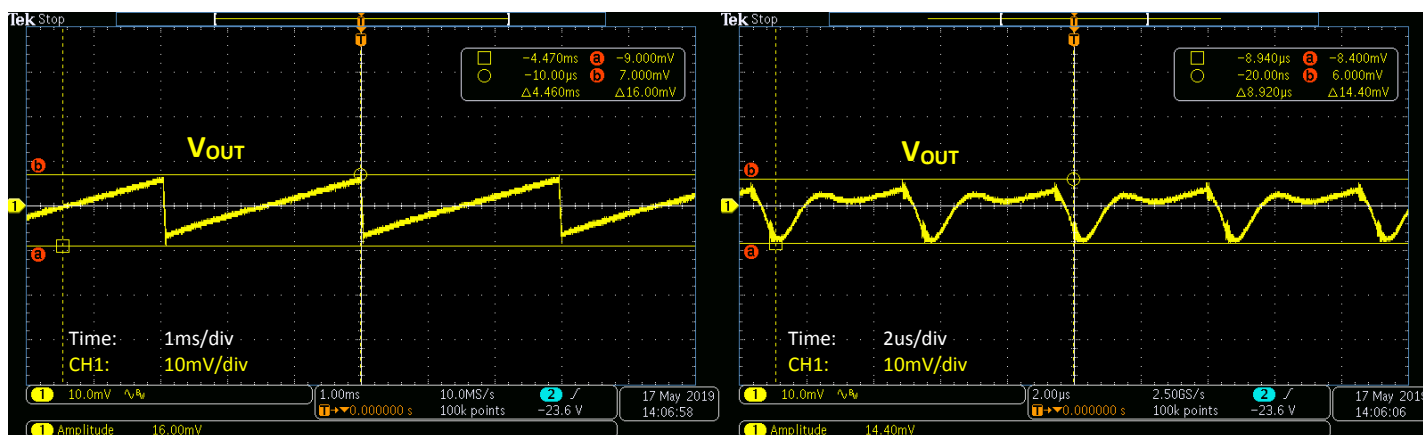

Figure 4.7. Si3404-Buck Non-Isolated EVB, 5 V, Class 2 Output Voltage Ripple No Load (Left) and Heavy Load (Right) Conditions

4.9 Soft-Start Protection

The Si3404 device has an integrated dynamic soft-start protection mechanism to avoid stressing the components by the sudden current or voltage changes associated with the initial charging of the output capacitors.

The Si3404 intelligent adaptive soft-start mechanism does not require any external component to install. The controller continuously measures the input current of the PD and dynamically adjusts the internal IPEAK limit during soft-start, that way adjusting the output voltage ramping up time in a function of the attached load.

The controller lets the output voltage to rise faster in no load (or light load) condition. With heavy load at the output, the controller slows down the output voltage ramp to avoid exceeding the desired regulated output voltage value.

No-Load Soft Start:
 $t_{RISE} = 7.6 \text{ ms}$

Heavy-Load Soft Start:
 $t_{RISE} = 79.7 \text{ ms}$

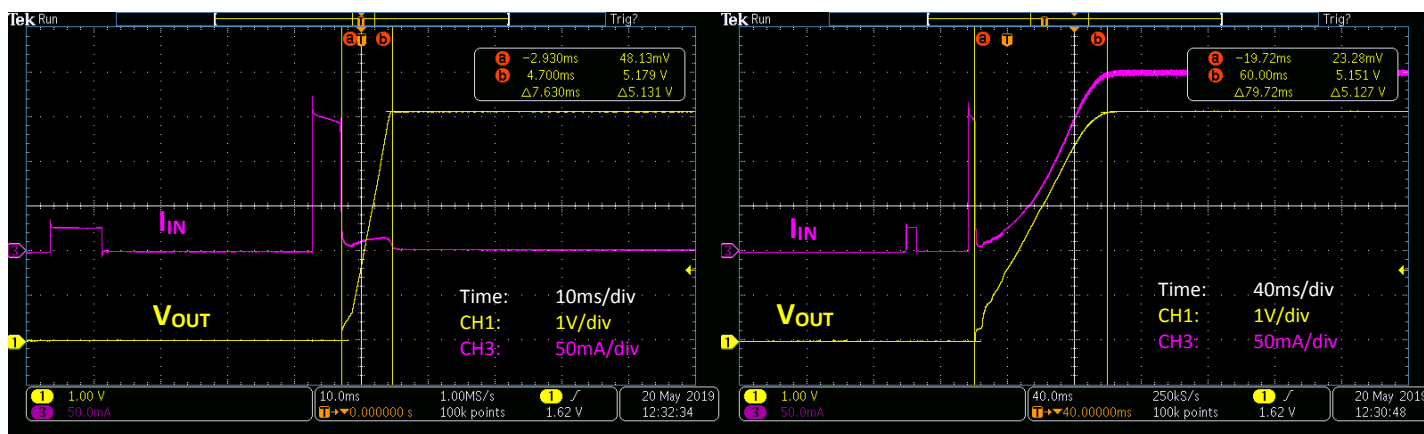

Figure 4.8. Si3404-Buck Non-Isolated EVB, 5 V, Class 2 Output Voltage Soft-Start at Low Load (Left) and Heavy Load (Right) Conditions

4.10 Output Short Protection

The Si3404 device has an integrated output short protection mechanism, which protects the IC itself and the surrounding external components from overheating in the case of electrical short on the output.

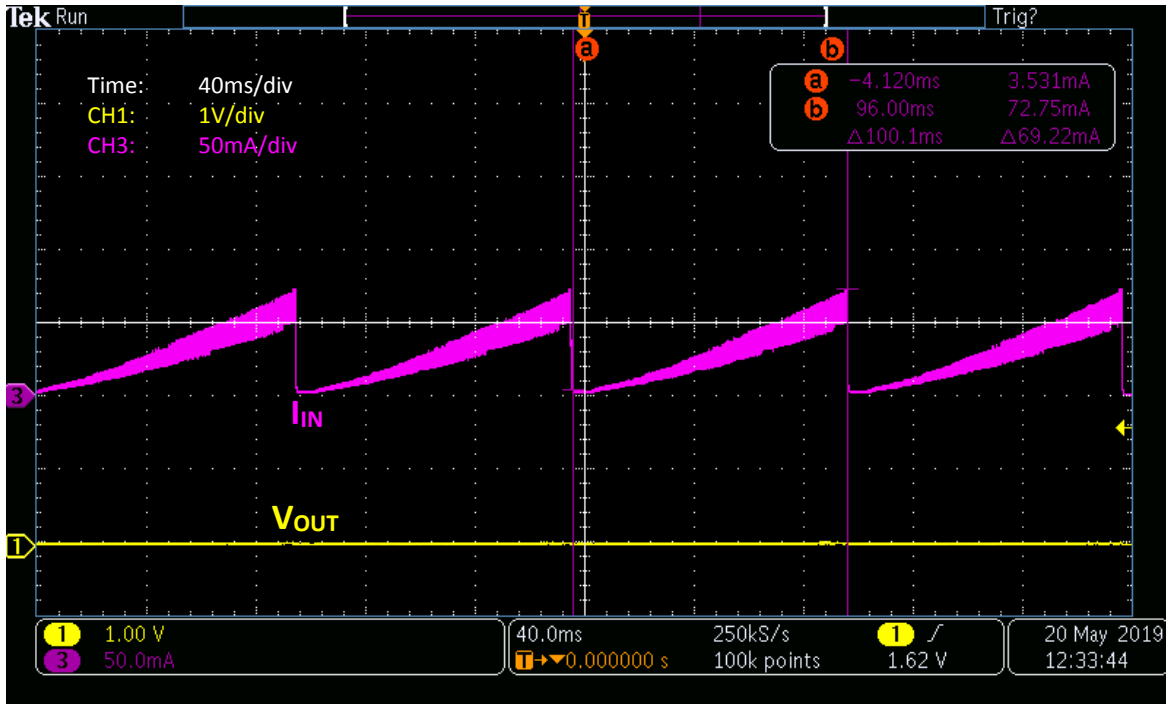

Figure 4.9. Si3404-Buck Non-Isolated EVB, 5 V, Class 2 Output Short Circuit Protection

4.11 Pulse Skipping at No-Load Condition

The Si3404 device has an integrated pulse skipping mechanism to ensure ultra-low power consumption under light load conditions.

As the output load decreases, the controller starts to reduce the pulse-width of the PWM signal (switcher ON time). At some point, even the minimum width pulse would provide higher energy than the application requires, which could result in loss of voltage regulation.

When the controller detects a light load condition (which requires less ON time than the minimum pulse width), the controller enters into burst or light-load skipping mode. This mode is shown in the following figure by depicting the switching node of the integrated switching FET at a no-load condition.

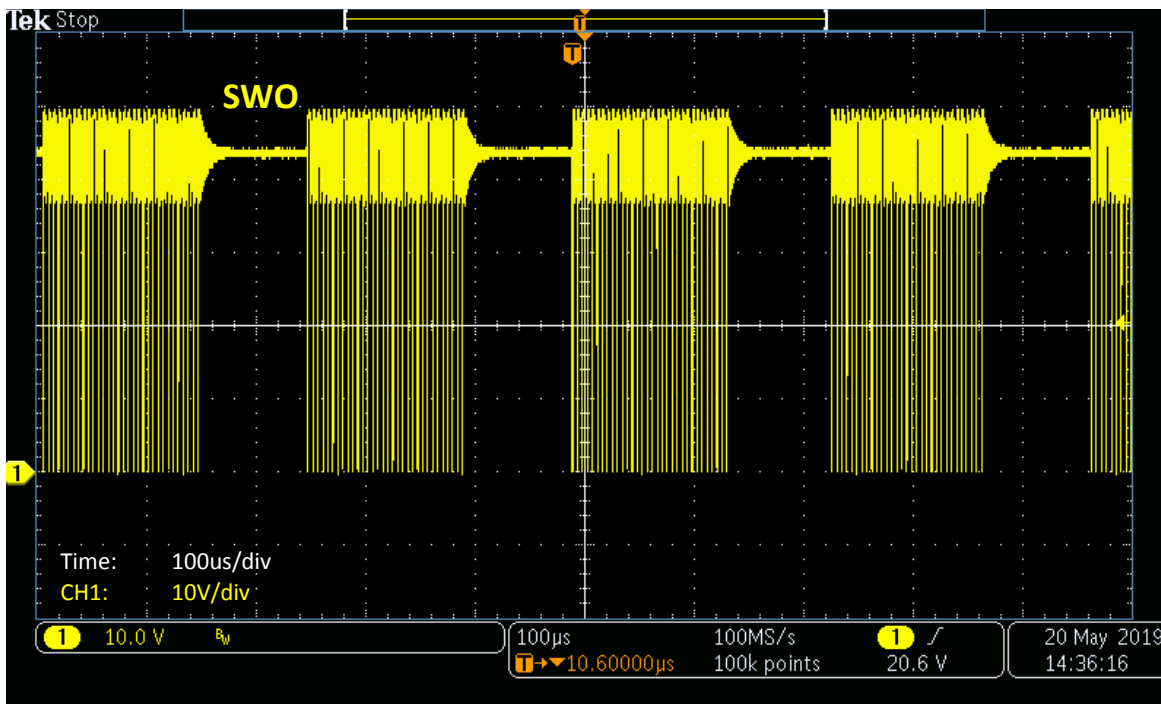

Figure 4.10. Si3404-Buck Non-Isolated EVB, 5 V, Class 2 Pulse Skipping at No-load Condition: SWO Waveform

4.12 Discontinuous (DCM) and Continuous (CCM) Current Modes

At low-load, the converter works in discontinuous current mode (DCM). At heavy load, the converter runs in continuous current mode (CCM). At low-load, the SWO voltage waveform has a ringing waveform, which is typical for a DCM operation.

Low-Load, DCM

Heavy-Load, CCM

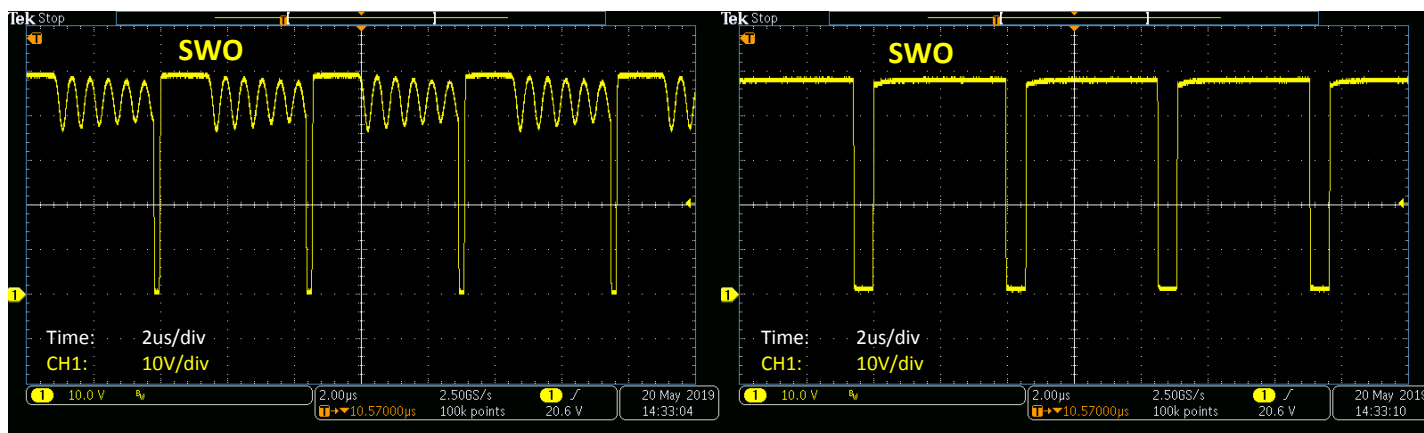

Figure 4.11. Si3404-Buck Non-Isolated EVB, 5 V, Class 2: SWO Waveform in Discontinuous Current Mode (DCM) at Low Load (Left), and in Continuous Current Mode (CCM) at Heavy Load (Right)

4.13 Radiated Emissions Measurement Results

Radiated emissions of the Si3404-Buck EVB board have been measured with 50 V input voltage and full load connected to the output (6.5 W).

As shown in the following figure, the Si3404-Buck, 5 V, Class 2 EVB is fully compliant with the international EN 55032 class B emissions standard.

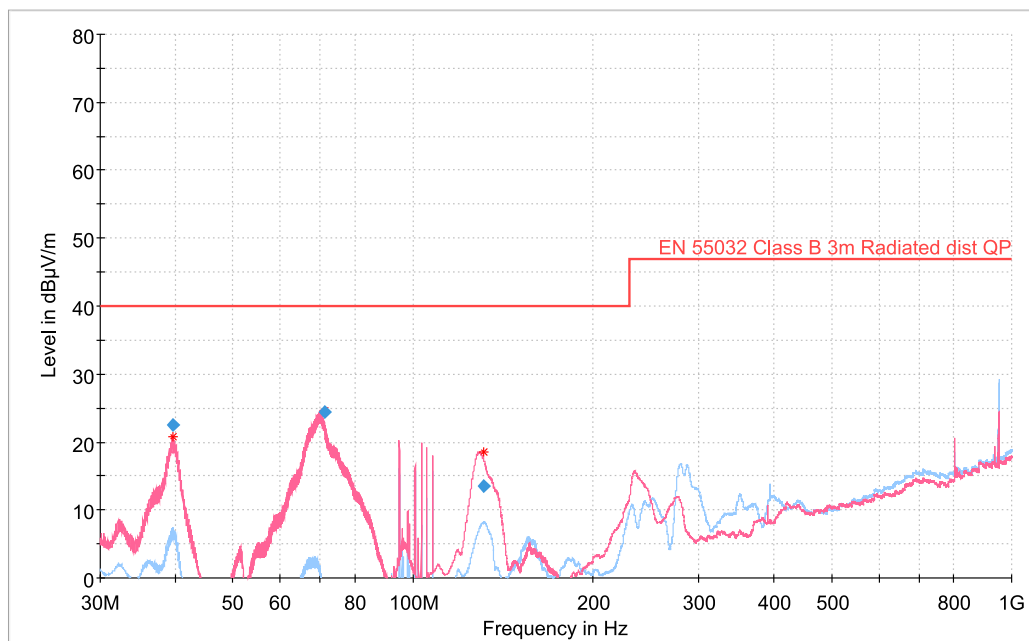

Figure 4.12. Si3404-Buck Non-Isolated EVB Radiated Emissions Measurements Results; 50 V Input, 5 V Output, 6.5 W Output Load

The EVB is measured at full load with peak detection in both vertical and horizontal polarizations. This is a relatively fast process that produces a red curve (vertical polarization) and a blue curve (horizontal polarization). Next, specific frequencies are selected (red stars) for quasi-peak measurements. The board is measured again at those specific frequencies with a quasi-peak detector, which is a very slow but accurate measurement. The results of this quasi-peak detector measurement are the blue rhombuses.

The blue rhombuses represent the final result of the measurement process. To have passing results, the blue rhombuses should be below the highlighted EN 55032 Class B limit.

4.14 Conducted Emissions Measurement Results

The Si3404-Buck, 5 V, Class 2 EVB board's conducted emissions have been measured in two different measurement methods to comply with the international EN 55032 standard. The EVB is supplied and measured on its PoE input port as shown in the following figure.

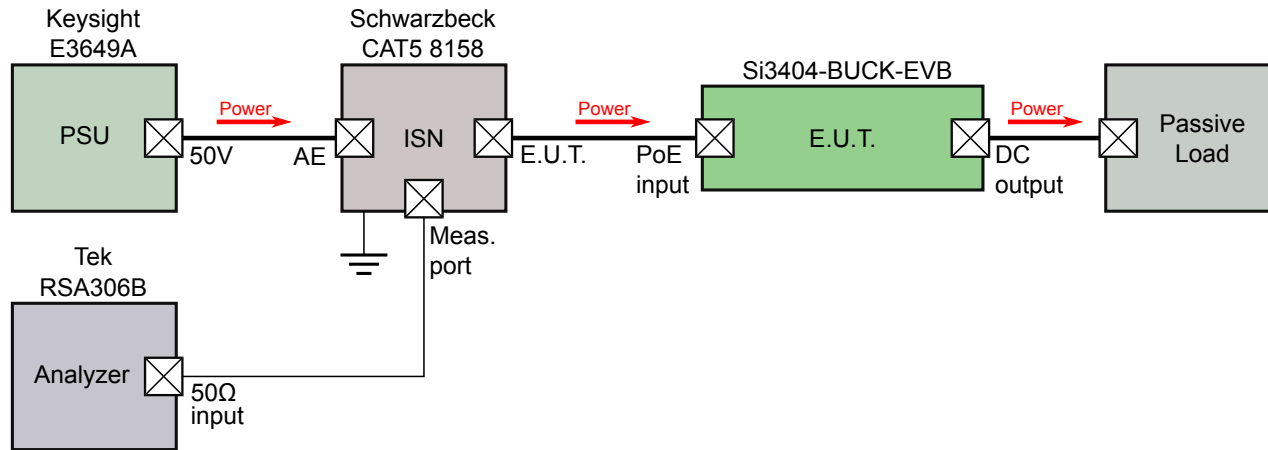

Figure 4.13. Conducted EMI Measurement Setup

The detector in the spectrum analyzer is set to:

- Peak detector and
- Average detector

Both results are shown in the following figure.

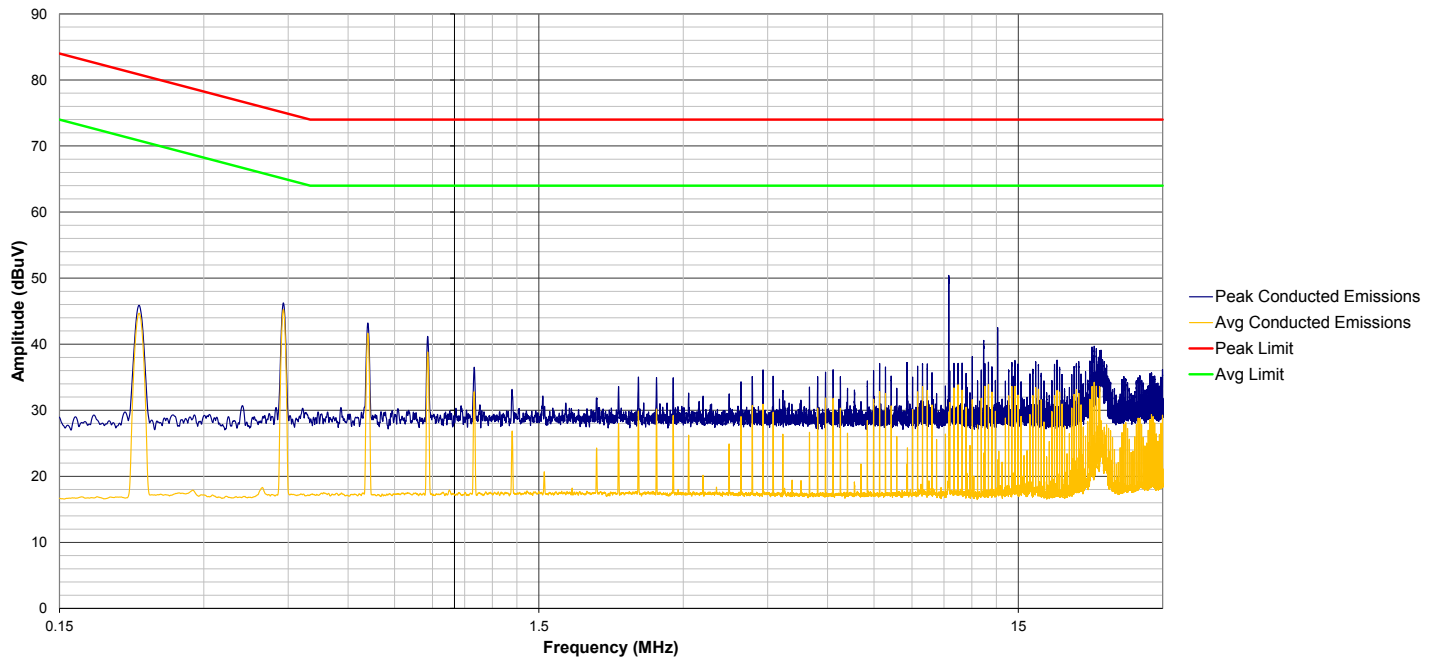

Figure 4.14. Si3404-Buck Non-Isolated EVB Conducted Emissions Measurements Results; 50 V Input, 5 V Output, 6.5 W Output Load

4.15 Bill of Materials

The following table is the BOM listing for the standard 5 V output evaluation board with option PoE Class 2.

Table 4.3. Si3404-Buck 5 V Bill of Materials

Designator	Quantity	Description	Manufacturer	Manufacturer Part Number
C1	1	CAP, 1 μ F, 100 V, \pm 10%, X7R, 1210	Venkel	C1210X7R101-105K
C13	1	CAP, 0.1 μ F, 100 V, \pm 10%, X7R, 0805	Venkel	C0805X7R101-104K
C14	1	CAP, 330 pF, 50 V, \pm 1%, C0G, 0805	Venkel	C0805C0G500-331F
C19	1	CAP, 0.1 μ F, 16 V, \pm 10%, X7R, 0805	Venkel	C0805X7R160-104K
C2	1	CAP, 12 μ F, 100 V, \pm 20%, AL, 6.3 x 11.2 mm	Panasonic	EEUFC2A120
C4, C5	2	CAP, 100 μ F, 6.3 V, \pm 10%, X5R, 1210	Venkel	C1210X5R6R3-107K
C7	1	CAP, 47 μ F, 6.3 V, \pm 20%, X5R, 0805	Venkel	C0805X5R6R3-476M
D1	1	DIO, Schottky, 100 V, 3 A, PowerDI-5	Diodes Inc.	PDS3100-13
D2, D3, D4, D5, D7, D8, D9, D10	8	DIO, Single, 100 V, 1.0 A, SMA	Fairchild	S1B
J1	1	CONN, RJ-45, MAGJACK, 1 Port PoE	Bel	SI-52003-F
J2, J3	2	CONN, Banana Jack, Threaded Uninsulated	ABBATRON HH SMITH	101
L1, L3	2	Ferrite Bead, 700 Ω @150 MHZ, 0805	Würth	742792040
L2	1	Inductor, Power, Shielded, 47 μ H, \pm 20%, 1.6 A, SMD	Coilcraft	MSS1038-473ML
R1	1	RES, 1 k Ω , 1/10 W, \pm 1%, ThickFilm, 0805	Venkel	CR0805-10W-1001F
R10	1	RES, 88.7 k Ω , 1/8 W, \pm 1%, ThickFilm, 0805	Vishay	CRCW080588K7FKEA
R11	1	RES, 75 Ω , 1/10 W, \pm 1%, ThickFilm, 0805	Venkel	CR0805-10W-75R0F
R3	1	RES, 3.24 k Ω , 1/8 W, \pm 1%, ThickFilm, 0805	Vishay	CRCW08053K24FKEA
R4	1	RES, 9.09 k Ω , 1/10 W, \pm 25 PPM, \pm 0.5%, ThinFilm, 0805	Susumu	RR1220P-9091-D-M
R5	1	RES, 10 Ω , 1/10 W, \pm 1%, ThickFilm, 0805	Venkel	CR0805-10W-10R0F
R6	1	RES, 3 Ω , 1/8 W, \pm 1%, ThickFilm, 0805	Venkel	CR0805-8W-3R00FT
R7	1	RES, 1.2 Ω , 1/10 W, \pm 5%, ThickFilm, 0805	Venkel	CR0805-10W-1R2J
R8	1	RES, 143 k Ω , 1/10 W, \pm 1%, ThickFilm, 0805	Venkel	CR0805-10W-1433F
R9	1	RES, 24.3 k Ω , 1/8 W, \pm 1%, ThickFilm, 0805	vishay	CRCW080524K3FKEA
TP1, TP2, TP11, TP12	4	Testpoint, Black, 0.050" Loop, PTH	Keystone	5001

Designator	Quantity	Description	Manufacturer	Manufacturer Part Number
U1	1	IC, Fully-Integrated 802.3-Compliant PoE PD Interface and Low-EMI Switching Regulator, QFN20	SiLabs	Si3404-A-GM
Not-Installed Components				
C20	1	CAP, 330 pF, 50 V, ±1%, C0G, 0805	Venkel	C0805C0G500-331F
C3	1	CAP, 6.3 V, ±20%, AL, 8.0 x 11.5 mm		
C6	1	CAP, 50 V, ±10%, X7R, 0805		
C8	1	CAP, 6.3 V, ±10%, X5R, 1210		
C9, C10, C11, C12, C15, C16, C17, C18	8	CAP, 1 nF, 100 V, ±10%, X7R, 0603	Venkel	C0603X7R101-102K
D6	1	DIO, TVS, UNIDIR, 58 V, 400 W	Littelfuse	SMAJ58A
R2	1	RES, 1 kΩ, 1/10 W, ±1%, ThickFilm, 0805	Venkel	CR0805-10W-1001F
TP3, TP4, TP5, TP6, TP7, TP8, TP9, TP10	8	Testpoint, Black, 0.050" Loop, PTH	Keystone	5001

5. Si3404-Buck EVB: 12 V, Class 3 Configuration

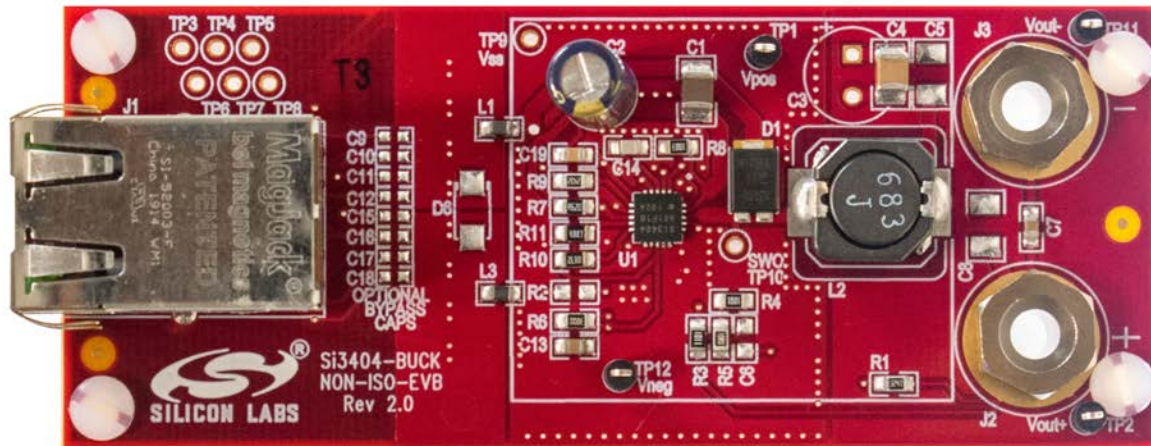

5.1 Si3404-Buck EVB Schematic: 12 V Class 3, 15.4 W

In the following figure, the schematic of the Si3404-Buck 12V, Class 3 EVB is shown. The parts in red on the schematic represent the BOM differences compared to the core design.

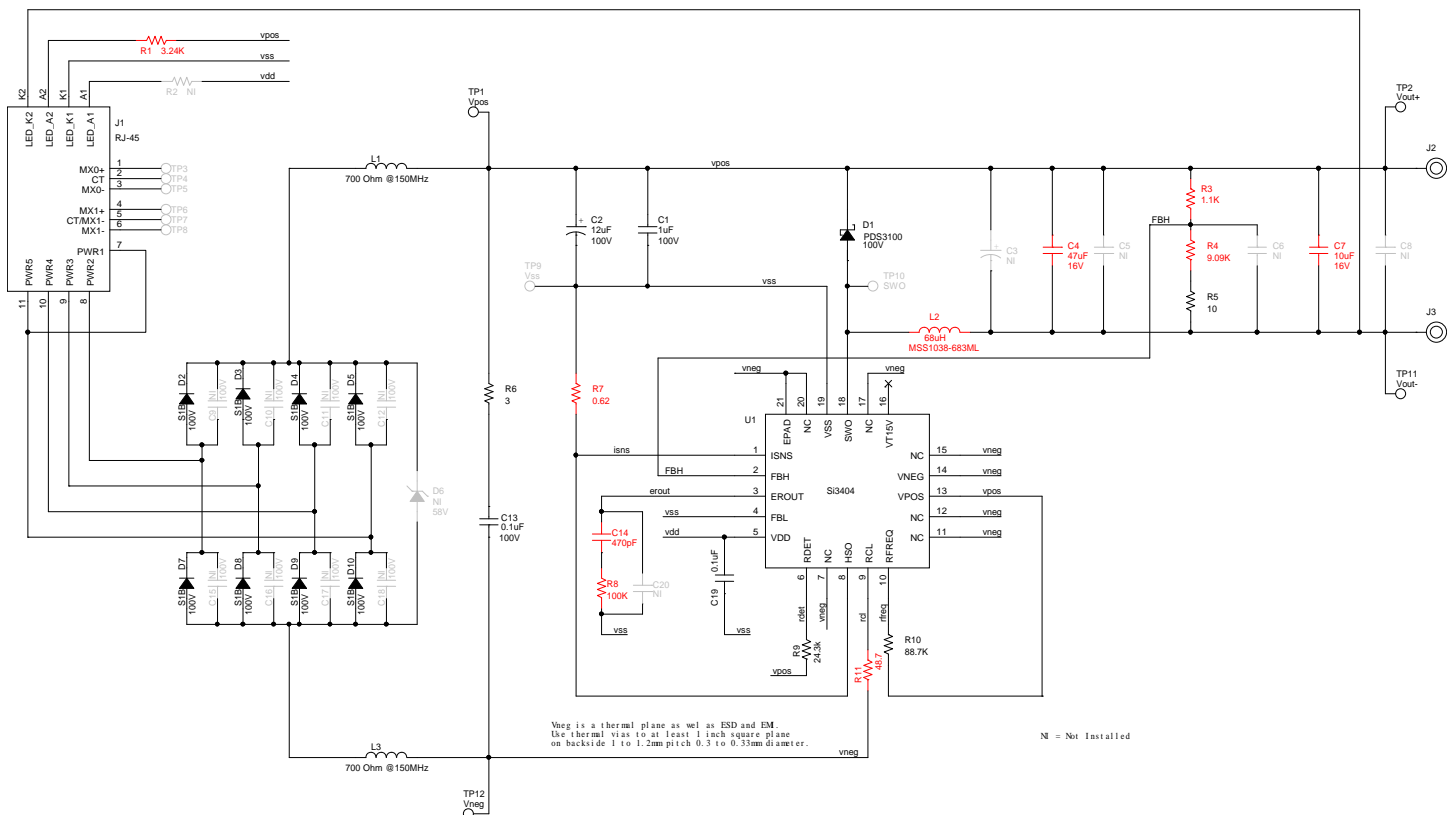

5.2 End-to-End EVB Efficiency

The end-to-end conversion efficiency measurement data of the Si3404 12 V Buck board is shown below with silicon and Schottky type input bridges. The input voltage is 50 V in both cases.

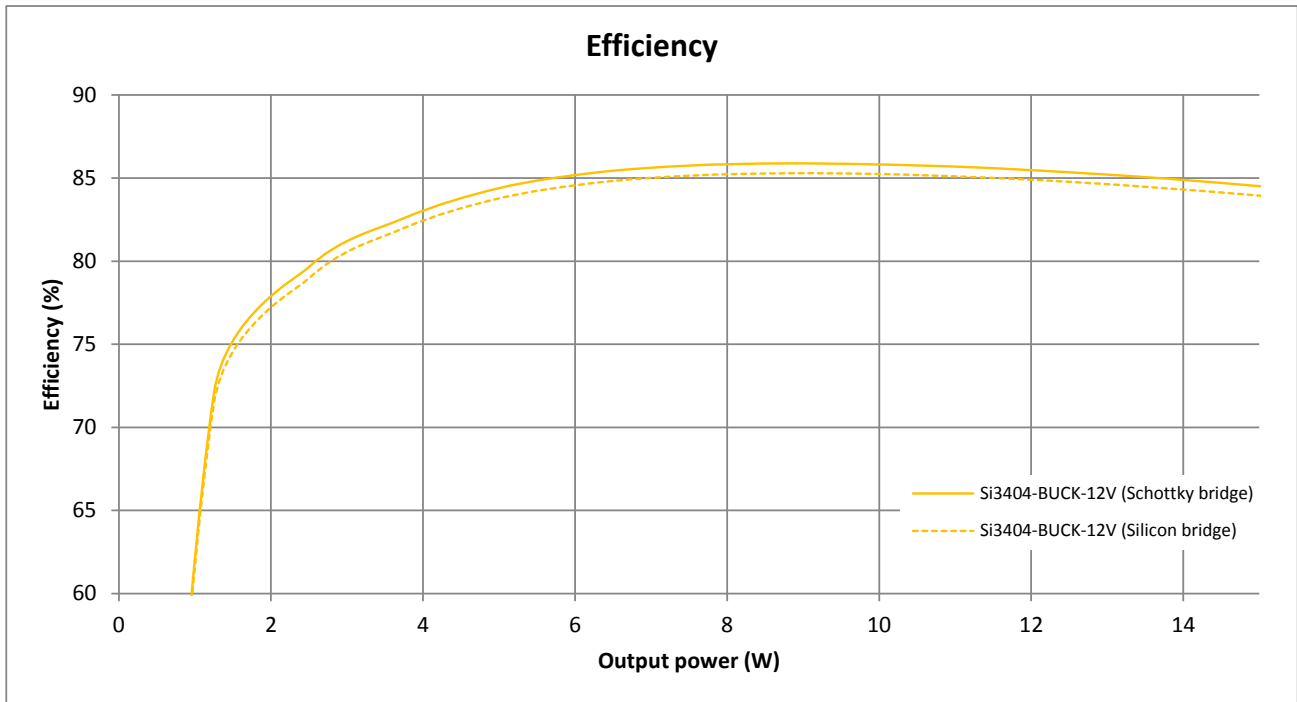

Figure 5.2. Si3404-Buck End-to-End Efficiency Chart with Silicon and Schottky Type Input Bridge Diodes: 50 V Input, 12 V Output, Class 3

Note: The chart shows end-to-end EVB efficiency. The voltage drop of the diode bridge is included. LEDs are removed.

5.3 Thermal Measurements

The Si3404-Buck EVB's temperature was measured at maximum **output power – 13 W**. The Si3404-Buck EVB is configured for 12 V output voltage and Class 3 power level. The following figure shows the thermal images taken of the EVB board at maximum output power.

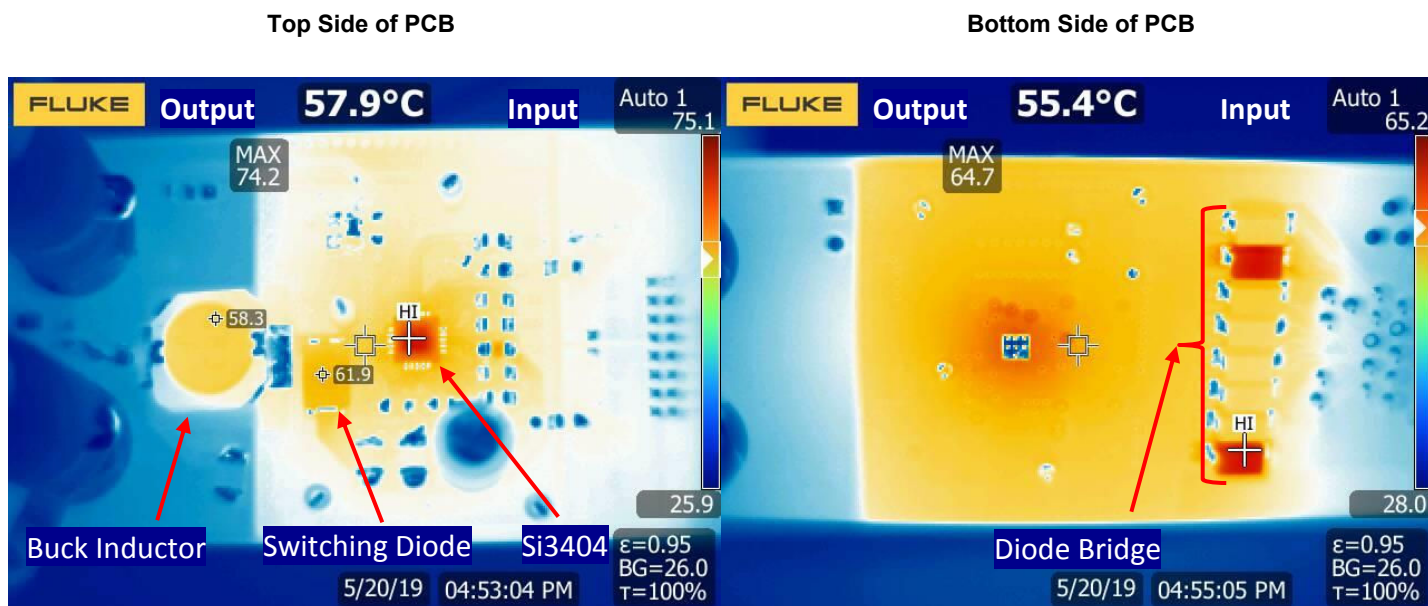

Figure 5.3. Thermal Measurements of the Si3404-Buck Non-Isolated EVB, 12 V, Class 3 PD

The following table lists the temperatures of the notable components across the board.

Table 5.1. Component Temperatures at Full Load

Component	Temperature
Si3404 – U1	74.2 °C
Switching Diode – D1	61.9 °C
Buck Inductor – L2	58.3 °C
Diode Bridge – D2-D5, D7-D10	64.7 °C

Note: The ambient temperature was 26 °C during the thermal measurements.

5.4 SIFOS PoE Compatibility Test Results

The PDA-300 Powered Device Analyzer is a single-box comprehensive solution for testing IEEE 802.3at PoE Powered Devices (PD's). The Si3404-Buck EVB board has been successfully tested with the PDA-300 Powered Device Analyzer from SIFOS Technologies.

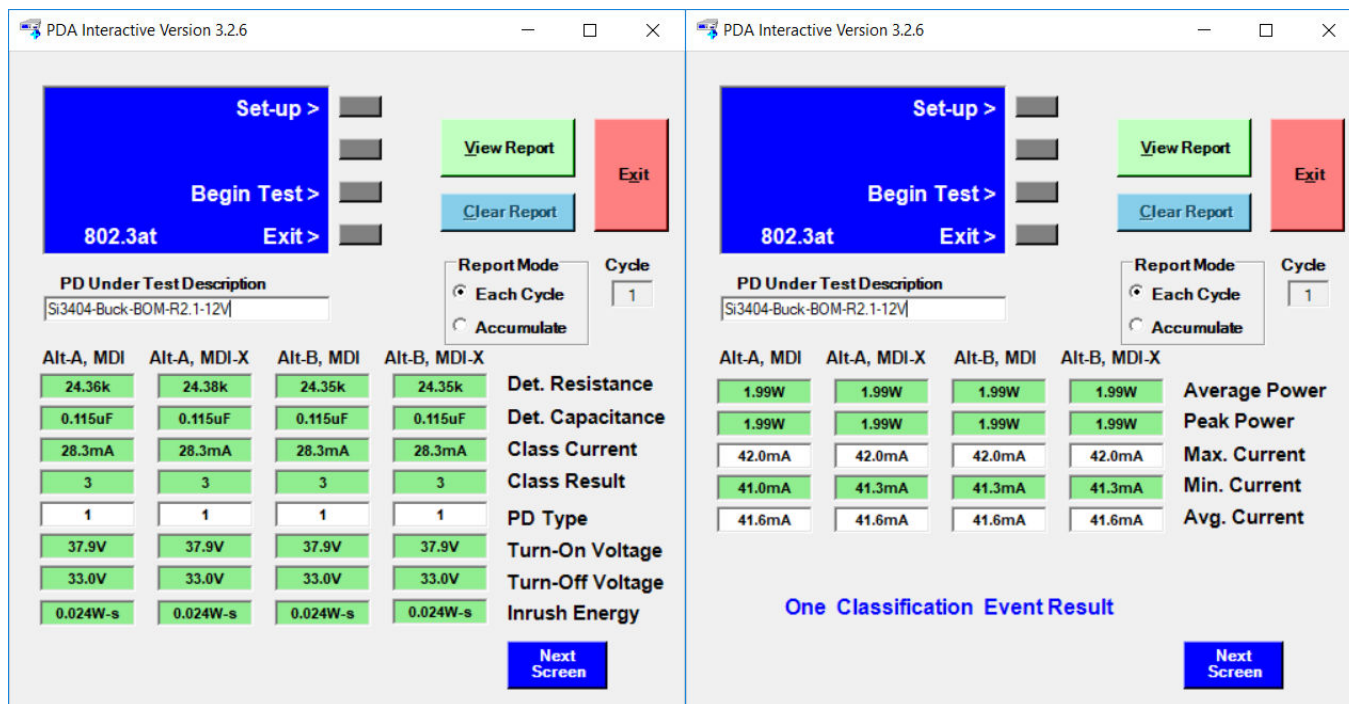

Figure 5.4. Si3404-Buck Non-Isolated EVB, 12 V, Class 3 PD SIFOS PoE Compatibility Test Results

5.5 Adjustable EVB Current Limit

For additional safety, the Si3404 has an adjustable EVB current limit feature.

The Si3404 controller measures the voltage on the R_{SENSE} resistor (R7) through the ISNS pin. Attention must be paid, that this voltage goes below V_{SS} . When the voltage on the R7 is $V_{ISNS} = -270$ mV (referenced to V_{SS}), the internal current limit circuit restarts the PD to protect the application.

The EVB current limit for this Class 3 application can be calculated with the following formula:

$$R_{SENSE} = 0.62\Omega$$

$$I_{LIMIT} = \frac{270mV}{0.62\Omega} = 435mA$$

Equation 5.1. EVB Class 3 Current Limit

5.6 Feedback Loop Phase and Gain Measurement Results (Bode Plots)

The Si3404 device integrates a current-mode-controlled switching mode power supply controller circuit. Therefore, the application is a closed-loop system. To guarantee stable output voltage of the power supply and to reduce the influence of the input voltage variations and load changes on the output voltage, the feedback loop should be stable.

To verify the stability of the loop, the loop gain and loop phase shift have been measured.

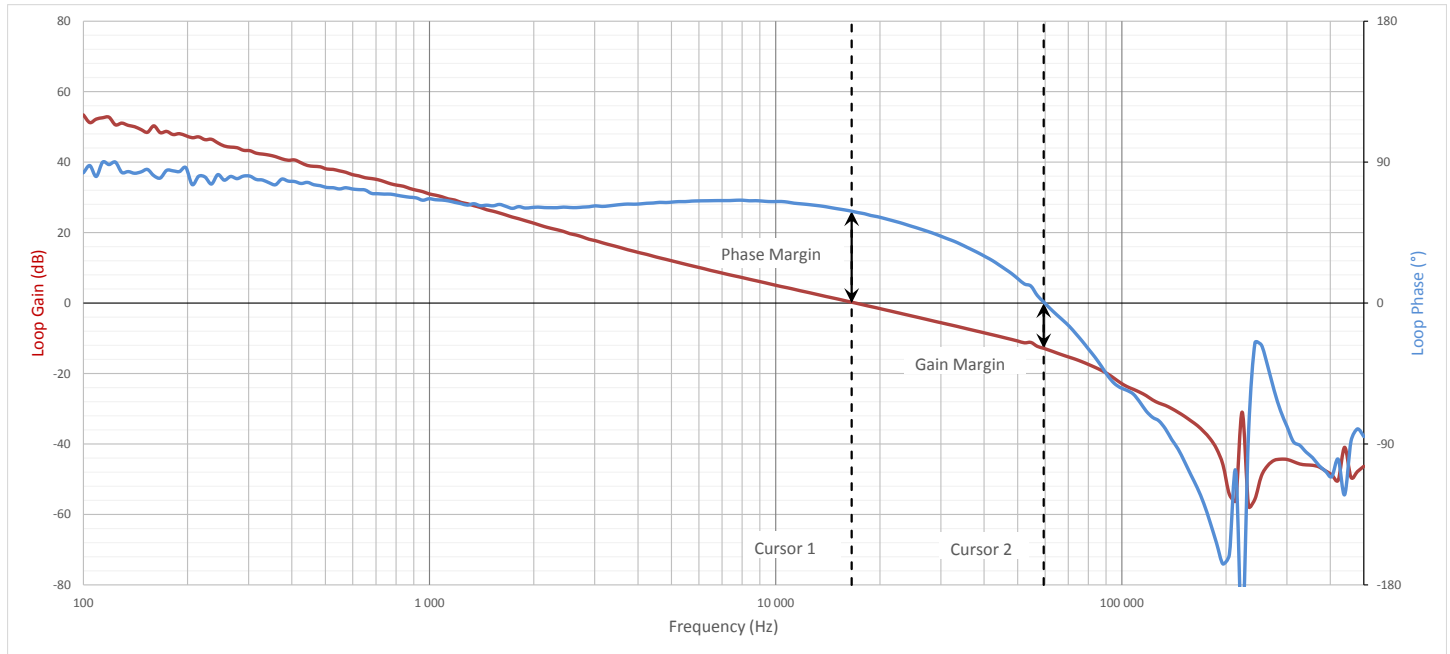

Figure 5.5. Si3404-Buck Non-Isolated EVB, 12 V, Class 3 PD Feedback Loop Measurement Results at Full Load

Table 5.2. Measured Loop Gain and Phase Margins

	Frequency	Gain	Phase
Cursor 1 (Phase Margin)	17 kHz	0 dB	58 °
Cursor 2 (Gain Margin)	59.9 kHz	-12.9 dB	0 °

5.7 Load Step Transient Measurement Results

The Si3404-Buck EVB board's output has been tested with a load step function to verify the converter's output dynamic response.

Load Step: from 0.1 to 0.9 A Output Current:
 $\Delta V_{OUT} = 500 \text{ mV}$

Load Step: from 0.9 to 0.1 A Output Current:
 $\Delta V_{OUT} = 450 \text{ mV}$

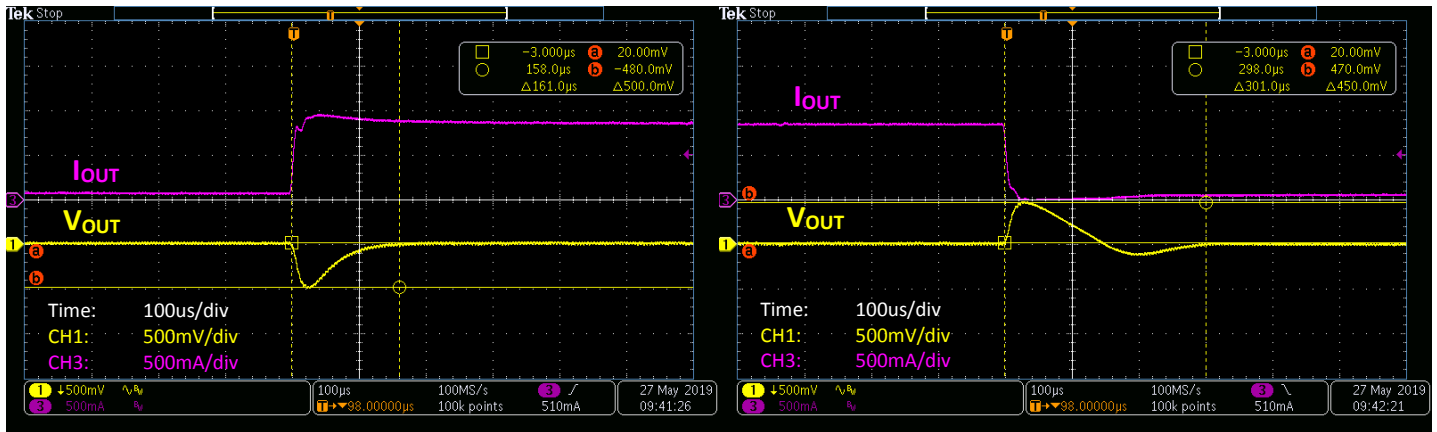

Figure 5.6. Si3404-Buck Non-Isolated EVB, 12 V, Class 3 PD Output Load Step Transient Test

5.8 Output Voltage Ripple

The Si3404-Buck EVB output voltage ripple has been measured in both no-load and heavy-load conditions.

No-Load V_{OUT} Ripple = 56.8 mV

Heavy-Load V_{OUT} Ripple = 23.6 mV

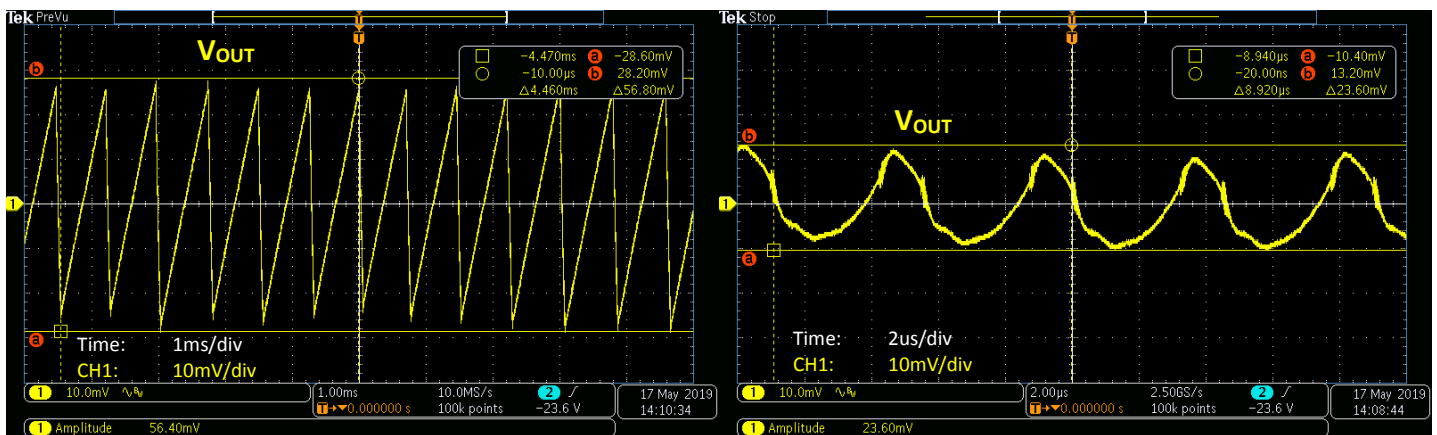

Figure 5.7. Si3404-Buck Non-Isolated EVB, 12 V, Class 3 Output Voltage Ripple No Load (Left) and Heavy Load (Right) Conditions

5.9 Soft-Start Protection

The Si3404 device has an integrated dynamic soft-start protection mechanism to avoid stressing the components by the sudden current or voltage changes associated with the initial charging of the output capacitors.

The Si3404 intelligent adaptive soft-start mechanism does not require any external component to install. The controller continuously measures the input current of the PD and dynamically adjusts the internal IPEAK limit during soft-start, that way adjusting the output voltage ramping up time in a function of the attached load.

The controller lets the output voltage to rise faster in no load (or light load) condition. With heavy load at the output, the controller slows down the output voltage ramp to avoid exceeding the desired regulated output voltage value.

No-Load Soft Start:
 $t_{RISE} = 6.1 \text{ ms}$

Heavy-Load Soft Start:
 $t_{RISE} = 85.4 \text{ ms}$

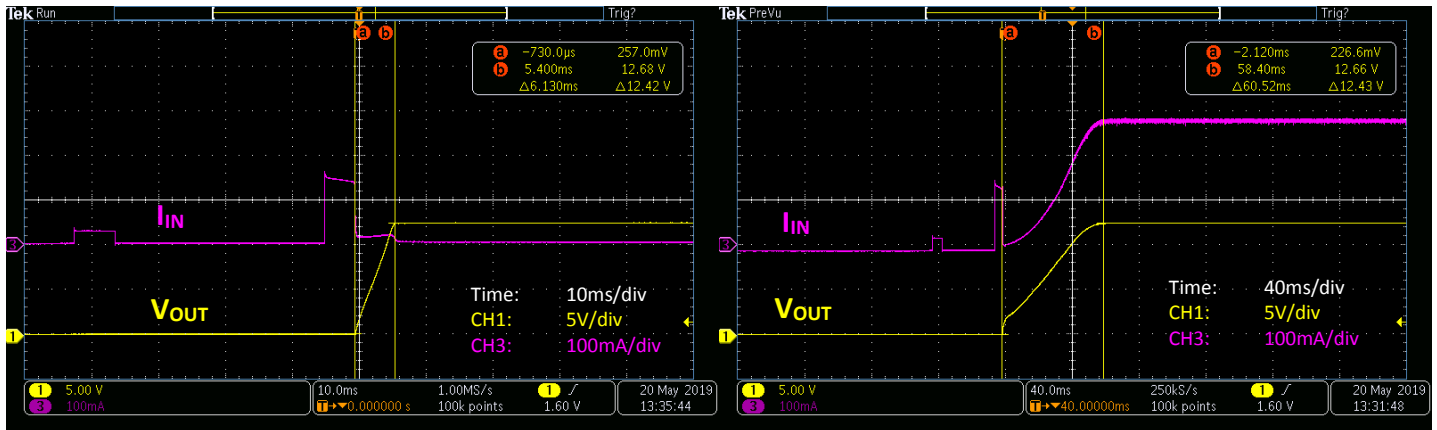

Figure 5.8. Si3404-Buck Non-Isolated EVB, 12 V, Class 3 Output Voltage Soft-Start at Low Load (Left) and Heavy Load (Right) Conditions

5.10 Output Short Protection

The Si3404 device has an integrated output short protection mechanism, which protects the IC itself and the surrounding external components from overheating in the case of electrical short on the output.

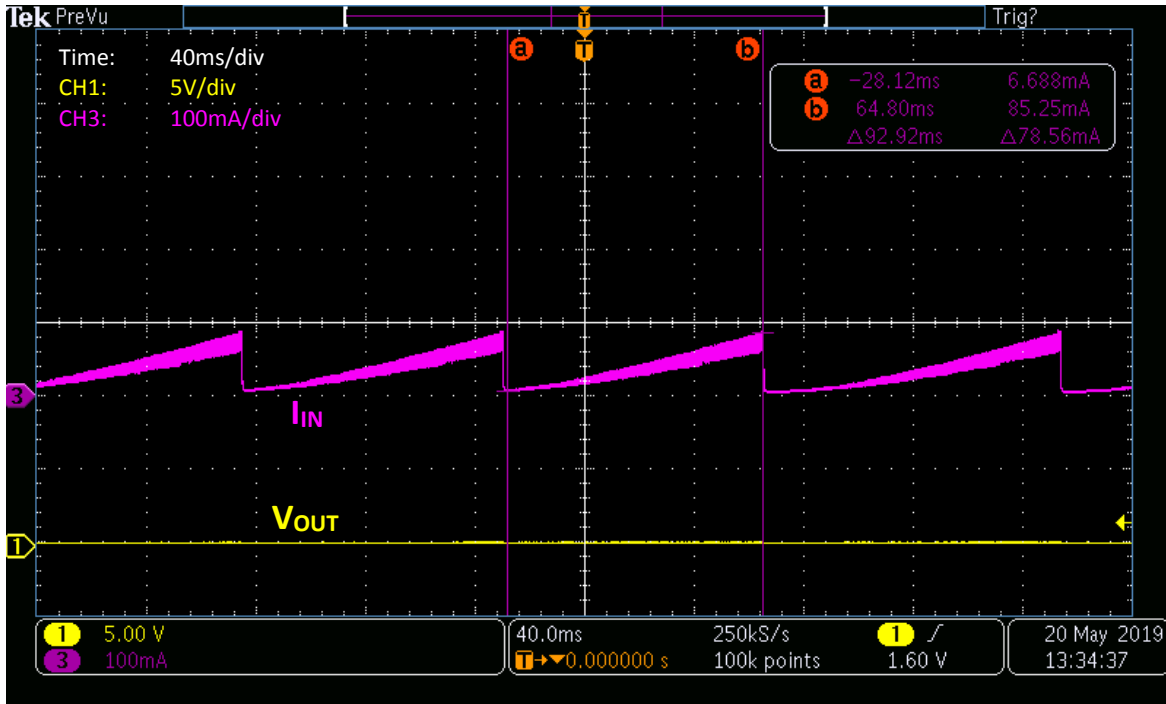

Figure 5.9. Si3404-Buck Non-Isolated EVB, 12 V, Class 3 Output Short Circuit Protection

5.11 Pulse Skipping at No-Load Condition

The Si3404 device has an integrated pulse skipping mechanism to ensure ultra-low power consumption under light load conditions.

As the output load decreases, the controller starts to reduce the pulse-width of the PWM signal (switcher ON time). At some point, even the minimum width pulse would provide higher energy than the application requires, which could result in loss of voltage regulation.

When the controller detects a light load condition (which requires less ON time than the minimum pulse width), the controller enters into burst or light-load skipping mode. This mode is shown in the following figure by depicting the switching node of the integrated switching FET at a no-load condition.

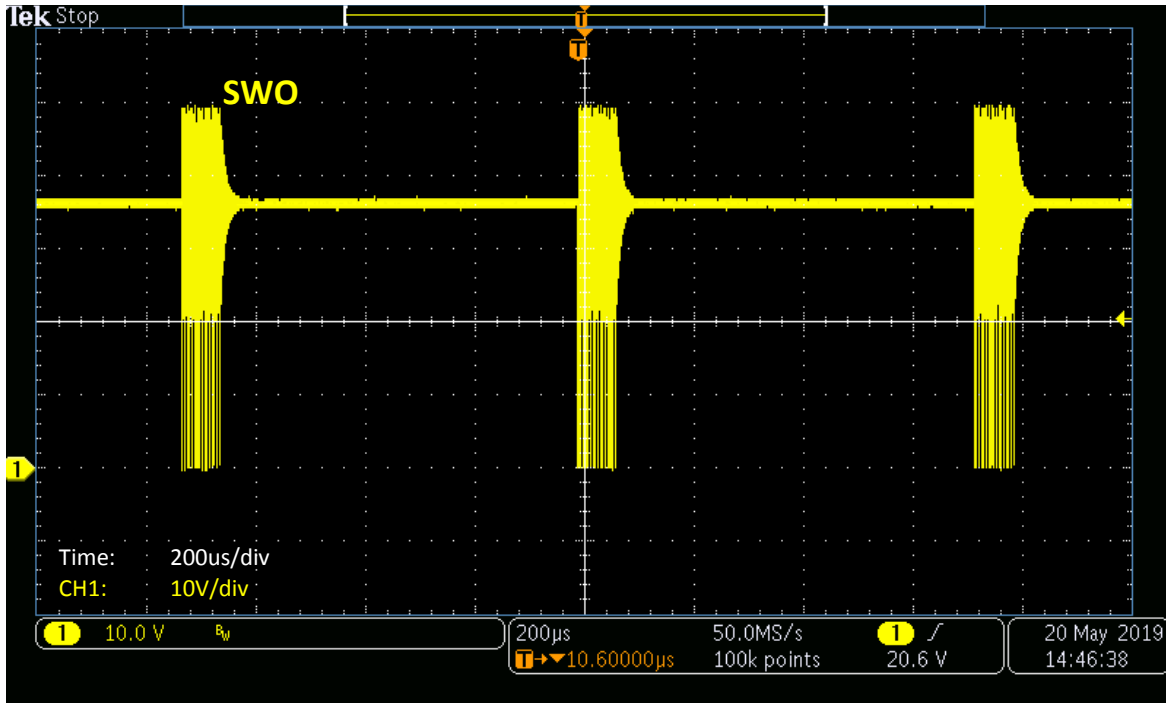

Figure 5.10. Si3404-Buck Non-Isolated EVB, 12 V, Class 3 Pulse Skipping at No-load Condition: SWO Waveform

5.12 Discontinuous (DCM) and Continuous (CCM) Current Modes

At low-load, the converter works in discontinuous current mode (DCM). At heavy load, the converter runs in continuous current mode (CCM). At low-load, the SWO voltage waveform has a ringing waveform, which is typical for a DCM operation.

Low-Load, DCM

Heavy-Load, CCM

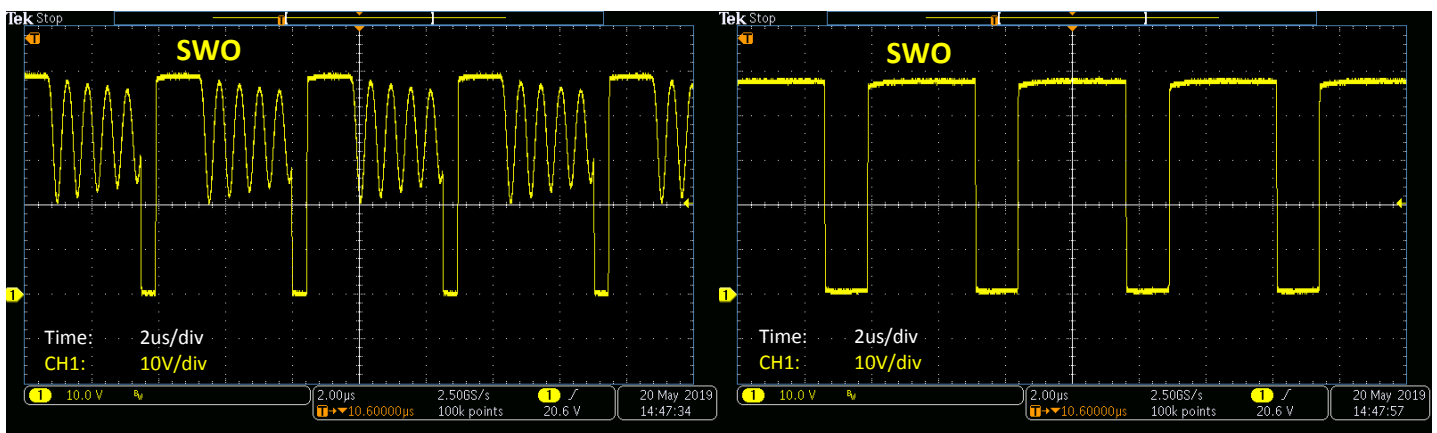

Figure 5.11. Si3404-Buck Non-Isolated EVB, 12 V, Class 3: SWO Waveform in Discontinuous Current Mode (DCM) at Low Load (Left), and in Continuous Current Mode (CCM) at Heavy Load (Right)

5.13 Radiated Emissions Measurement Results

Radiated emissions of the Si3404-Buck, 12 V, Class 3 EVB board have been measured with 50 V input voltage and full load connected to the output (13 W).

As shown in the following figure, the Si3404-Buck, 12 V, Class 3 EVB is fully compliant with the international EN 55032 class B emissions standard.

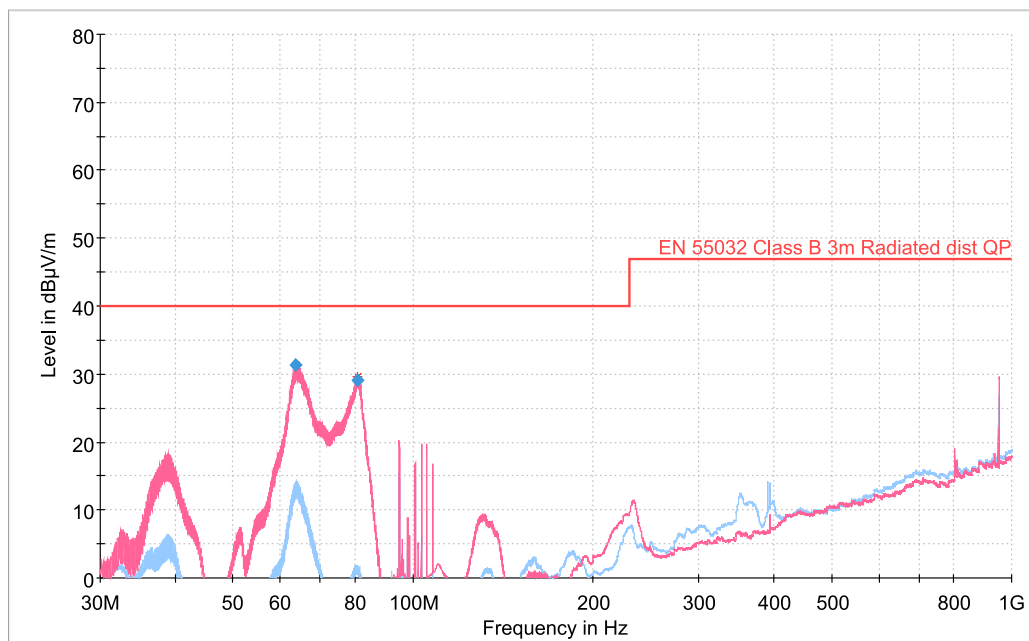

Figure 5.12. Si3404-Buck Non-Isolated EVB Radiated Emissions Measurements Results; 50 V Input, 12 V Output, 13 W Output Load

The EVB is measured at full load with peak detection in both vertical and horizontal polarizations. This is a relatively fast process that produces a red curve (vertical polarization) and a blue curve (horizontal polarization). Next, specific frequencies are selected (red stars) for quasi-peak measurements. The board is measured again at those specific frequencies with a quasi-peak detector, which is a very slow but accurate measurement. The results of this quasi-peak detector measurement are the blue rhombuses.

The blue rhombuses represent the final result of the measurement process. To have passing results, the blue rhombuses should be below the highlighted EN 55032 Class B limit.

5.14 Conducted Emissions Measurement Results

The conducted emissions of the Si3404-Buck, 12 V, Class 3 EVB board have been measured in two different measurement methods to comply with the international EN 55032 standard. The EVB is supplied and measured on its PoE input port as shown in the following figure.

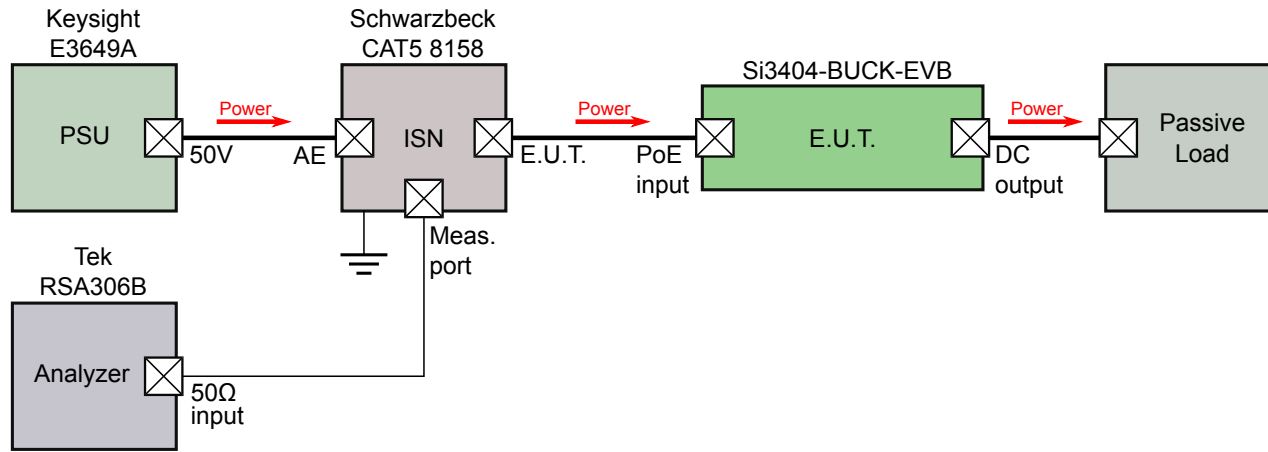

Figure 5.13. Conducted EMI Measurement Setup

The detector in the spectrum analyzer is set to:

- Peak detector and
- Average detector

Both results are shown in the following figure.

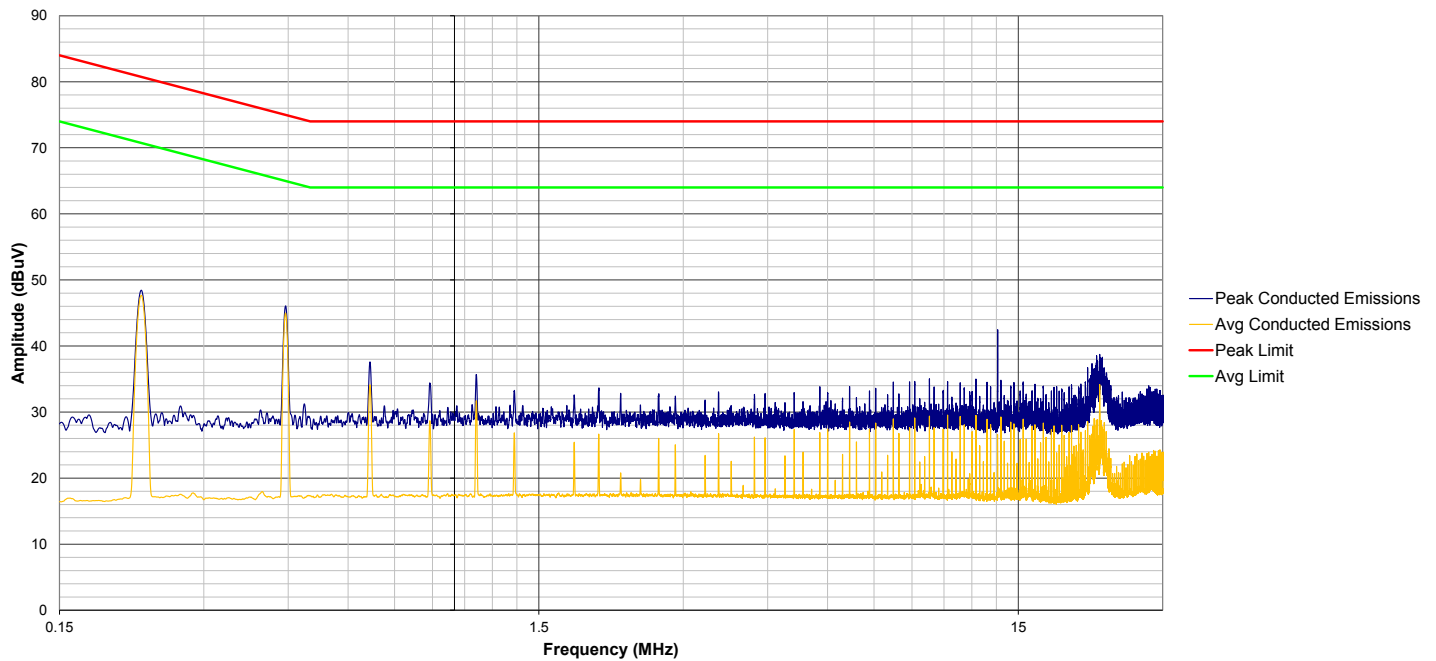

Figure 5.14. Si3404-Buck Non-Isolated EVB Conducted Emissions Measurements Results; 50 V Input, 12 V Output, 13 W Output Load

5.15 Bill of Materials

The following table is the BOM listing for the standard 12 V output evaluation board with option PoE Class 3.

Table 5.3. Si3404-Buck 12 V Bill of Materials

Designator	Quantity	Description	Manufacturer	Manufacturer Part Number
C1	1	CAP, 1 μ F, 100 V, \pm 10%, X7R, 1210	Venkel	C1210X7R101-105K
C13	1	CAP, 0.1 μ F, 100 V, \pm 10%, X7R, 0805	Venkel	C0805X7R101-104K
C14	1	CAP, 470 pF, 50 V, \pm 1%, C0G, 0805	Venkel	C0805C0G500-471F
C19	1	CAP, 0.1 μ F, 16 V, \pm 10%, X7R, 0805	Venkel	C0805X7R160-104K
C2	1	CAP, 12 μ F, 100 V, \pm 20%, AL, 6.3X11.2MM	Panasonic	EEUFC2A120
C4	1	CAP, 47 μ F, 16 V, \pm 20%, X5R, 1210	Venkel	C1210X5R160-476MNE
C7	1	CAP, 10 μ F, 16 V, \pm 10%, X5R, 0805	Venkel	C0805X5R160-106K
D1	1	DIO, Schottky, 100 V, 3 A, PowerDI-5	Diodes Inc.	PDS3100-13
D2, D3, D4, D5, D7, D8, D9, D10	8	DIO, Single, 100 V, 1.0 A, SMA	Fairchild	S1B
J1	1	CONN, RJ-45, MAGJACK, 1 Port PoE	Bel	SI-52003-F
J2, J3	2	CONN, Banana Jack, Threaded un-insulated	Abbatron HH Smith	101
L1, L3	2	Ferrite Bead, 700 Ω @150 MHz, 0805	Würth	742792040
L2	1	Inductor, Power, Shielded, 68 μ H, \pm 20%, 1.32 A, SMD	Coilcraft	MSS1038-683ML
R1	1	RES, 3.24 k Ω , 1/8 W, \pm 1%, ThickFilm, 0805	Vishay	CRCW08053K24FKEA
R10	1	RES, 88.7 k Ω , 1/8 W, \pm 1%, ThickFilm, 0805	Vishay	CRCW080588K7FKEA
R11	1	RES, 48.7 Ω , 1/8 W, \pm 1%, ThickFilm, 0805	Vishay	CRCW080548R7FKTA
R3	1	RES, 1.1 k Ω , 1/10 W, \pm 1%, ThickFilm, 0805	Venkel	CR0805-10W-1101F
R4	1	RES, 9.09 k Ω , 1/10 W, \pm 25 PPM, \pm 0.5%, ThinFilm, 0805	Susumu	RR1220P-9091-D-M
R5	1	RES, 10 Ω , 1/10 W, \pm 1%, ThickFilm, 0805	Venkel	CR0805-10W-10R0F
R6	1	RES, 3 Ω , 1/8 W, \pm 1%, ThickFilm, 0805	Venkel	CR0805-8W-3R00FT
R7	1	RES, 0.62 Ω , 1/8 W, \pm 1%, ThickFilm, 0805	Yageo	RL0805FR-070R62L
R8	1	RES, 100 k Ω , 1/8 W, \pm 1%, ThickFilm, 0805	Venkel	CR0805-8W-1003F
R9	1	RES, 24.3 k Ω , 1/8 W, \pm 1%, ThickFilm, 0805	Vishay	CRCW080524K3FKEA
SO1, SO2, SO3, SO4	4	HDW, Standoff, 4-40 X 1/2" , Nylon	SPC Technology	2397

Designator	Quantity	Description	Manufacturer	Manufacturer Part Number
TP1, TP2, TP11, TP12	4	Testpoint, Black, 0.050" Loop, PTH	Keystone	5001
U1	1	IC, Fully-Integrated 802.3-Compliant PoE PD Interface and Low-EMI Switching Regulator, QFN20	Silicon Labs	Si3404-A-GM
Not-Installed Components				
C20	1	CAP, 330 pF, 50 V, ±1%, C0G, 0805	Venkel	C0805C0G500-331F
C3	1	CAP, 16 V, ±20%, AL, 8.0 x 11.5 mm		
C5, C8	2	CAP, 16 V, ±10%, X5R, 1210		
C6	1	CAP, 50 V, ±10%, X7R, 0805		
C9, C10, C11, C12, C15, C16, C17, C18	8	CAP, 1 nF, 100 V, ±10%, X7R, 0603	Venkel	C0603X7R101-102K
D6	1	DIO, TVS, UNIDIR, 58 V, 400 W	Littelfuse	SMAJ58A
R2	1	RES, 1 kΩ, 1/10 W, ±1%, ThickFilm, 0805	Venkel	CR0805-10W-1001F
TP3, TP4, TP5, TP6, TP7, TP8, TP9, TP10	8	Testpoint, Black, 0.050" Loop, PTH	Keystone	5001

6. Si3404-Buck EVB: 24 V, Class 3 Configuration

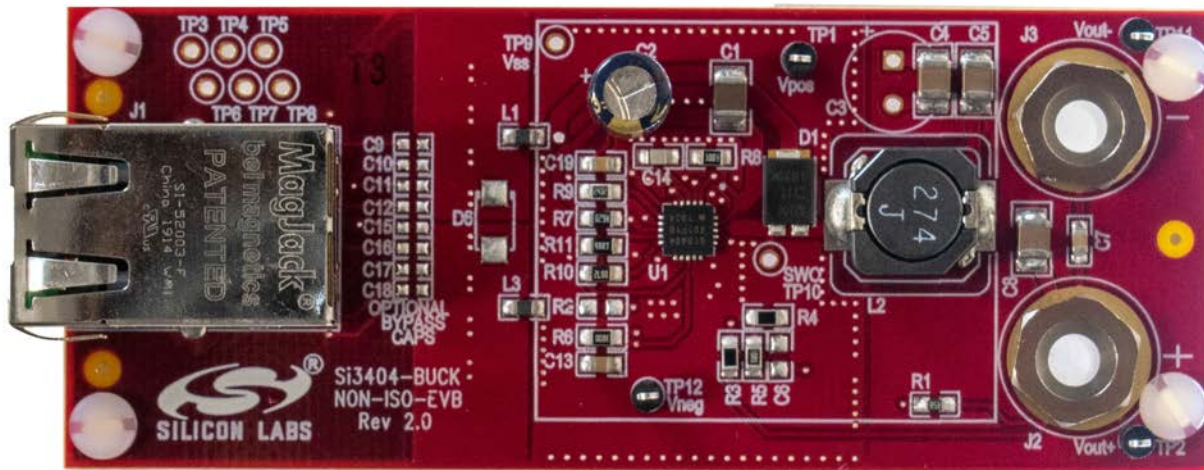

6.1 Si3404-Buck EVB Schematic: 24V, Class 3, 15.4W

The schematic of the Si3404-Buck 24V, Class 3 EVB is shown in the figure below. The parts in red on the schematic represent the BOM differences compared to the core design.

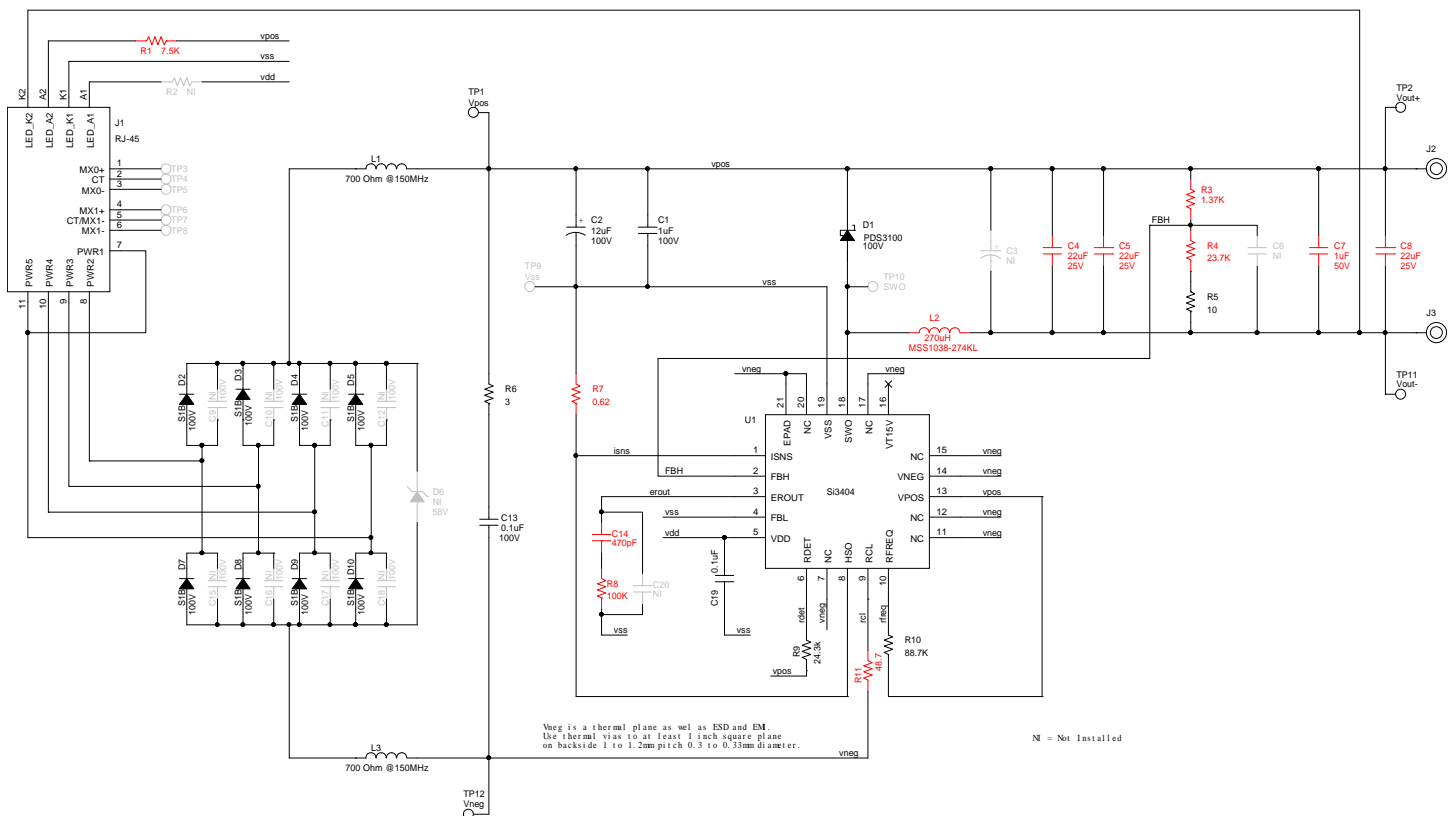

Figure 6.1. Si3404 Buck Non-Isolated EVB Schematic: 24 V, Class 3 PD

6.2 End-to-End EVB Efficiency

The end-to-end conversion efficiency measurement data of the Si3404 24 V Buck board is shown below with silicon and Schottky type input bridges. The input voltage is 50 V in both cases.

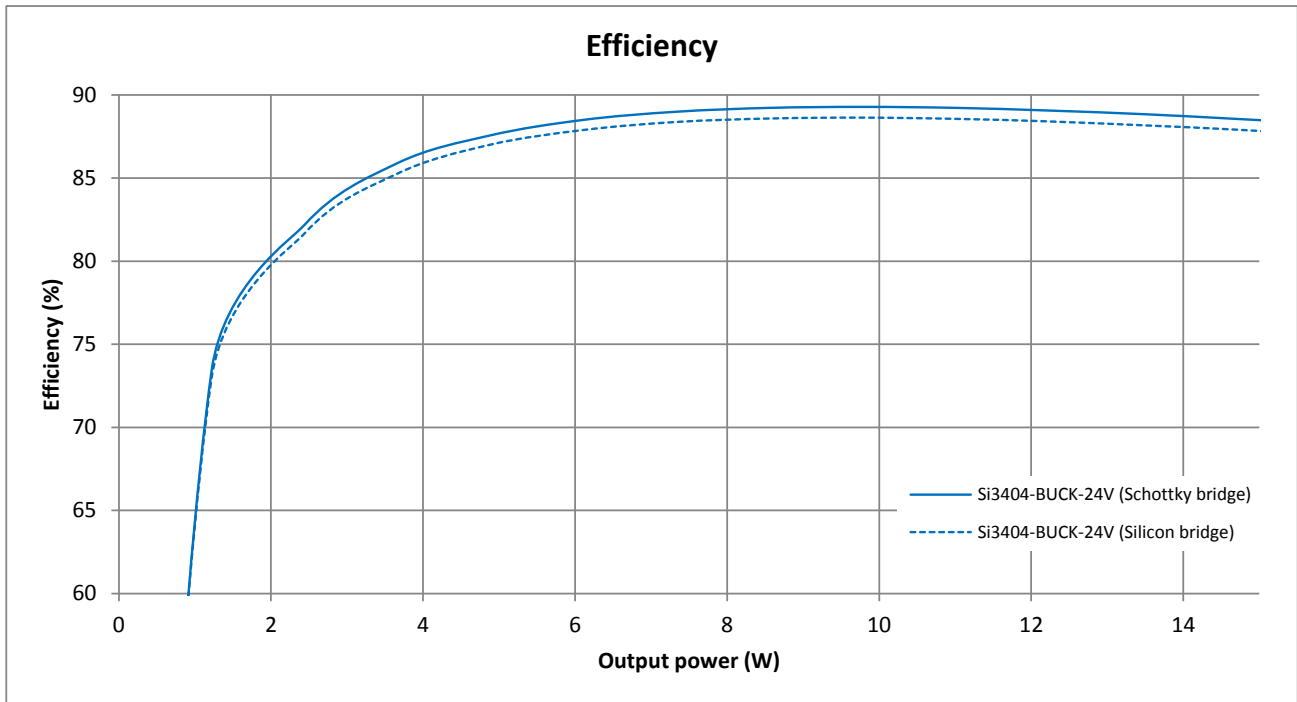

Figure 6.2. Si3404-Buck EVB End-to-End Efficiency Chart with Silicon and Schottky Type Input Bridge Diodes: 50 V Input, 24 V Output, Class 3

Note: The chart shows end-to-end EVB efficiency. The voltage drop of the diode bridge is included. LEDs are removed.

6.3 Thermal Measurements

The Si3404-Buck EVB's temperature was measured at maximum **output power – 13 W**. The Si3404-Buck EVB is configured for 24 V output voltage and Class 3 power level. The following figure shows the thermal images taken of the EVB board at maximum output power.

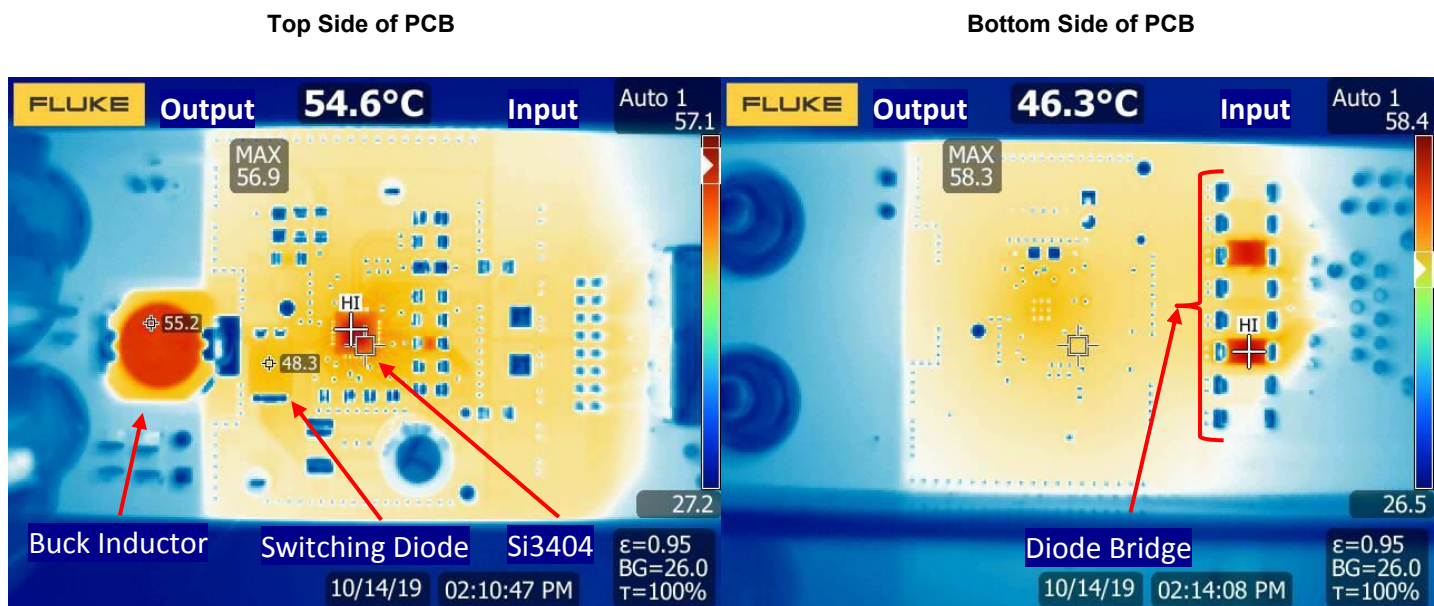

Figure 6.3. Thermal Measurements of the Si3404-Buck Non-Isolated EVB, 24 V, Class 3 PD

The following table lists the temperatures of the notable components across the board.

Table 6.1. Component Temperatures at Full Load

Component	Temperature
Si3404 – U1	59.6 °C
Switching Diode – D1	48.3 °C
Buck Inductor – L2	55.2 °C
Diode Bridge – D2-D5, D7-D10	58.3 °C

Note: The ambient temperature was 26 °C during the thermal measurements.

6.4 SIFOS PoE Compatibility Test Results

The PDA-300 Powered Device Analyzer is a single-box comprehensive solution for testing IEEE 802.3at PoE Powered Devices (PD's). The Si3404-Buck EVB board has been successfully tested with the PDA-300 Powered Device Analyzer from SIFOS Technologies.

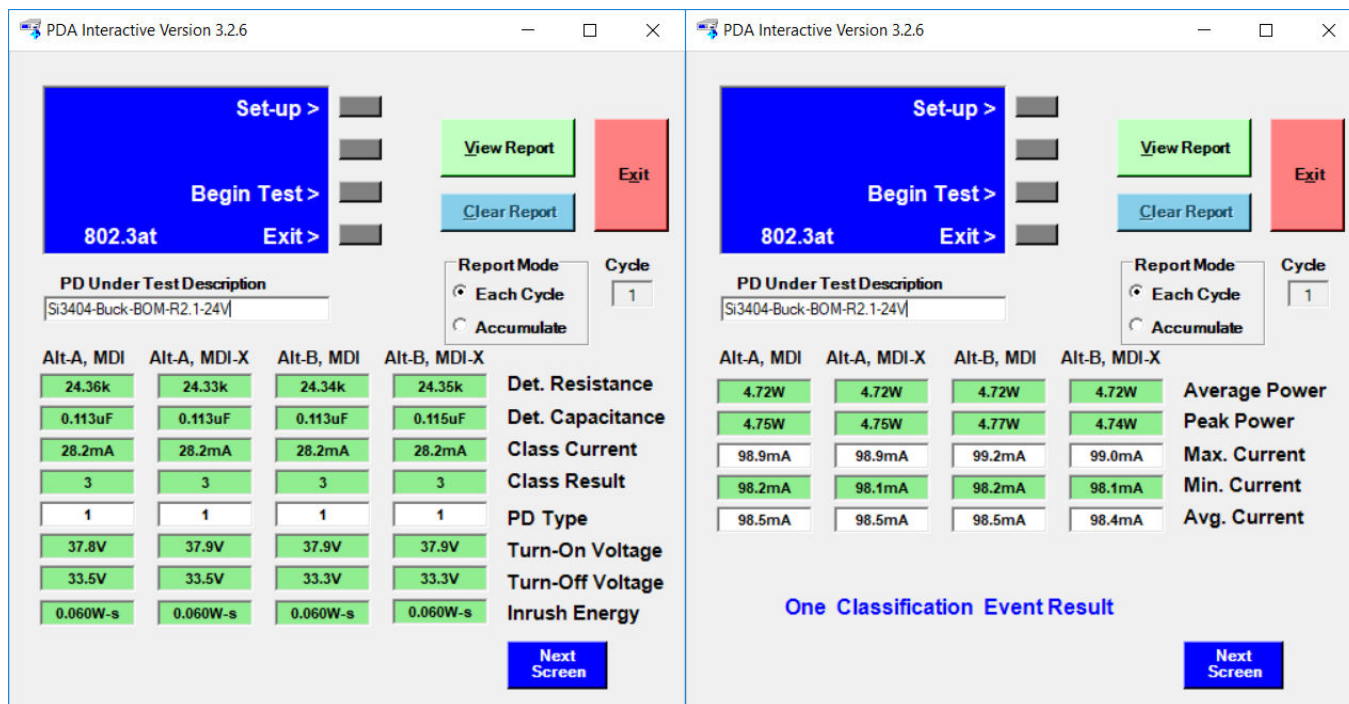

Figure 6.4. Si3404-Buck Non-Isolated EVB, 24 V, Class 3 PD SIFOS PoE Compatibility Test Results

6.5 Adjustable EVB Current Limit

For additional safety, the Si3404 has an adjustable EVB current limit feature.

The Si3404 controller measures the voltage on the R_{SENSE} resistor (R7) through the ISNS pin. Attention must be paid, that this voltage goes below V_{SS} . When the voltage on the R7 is $V_{ISNS} = -270\text{ mV}$ (referenced to V_{SS}), the internal current limit circuit restarts the PD to protect the application.

The EVB current limit for this Class 3 application can be calculated with the following formula:

$$R_{SENSE} = 0.62\Omega$$

$$I_{LIMIT} = \frac{270\text{mV}}{0.62\Omega} = 435\text{mA}$$

Equation 6.1. EVB Class 3 Current Limit

6.6 Feedback Loop Phase and Gain Measurement Results (Bode Plots)

The Si3404 device integrates a current-mode-controlled switching mode power supply controller circuit. Therefore, the application is a closed-loop system. To guarantee a stable output voltage of the power supply and to reduce the influence of the input voltage variations and load changes on the output voltage, the feedback loop should be stable.

To verify the stability of the loop, the loop gain and loop phase shift have been measured.

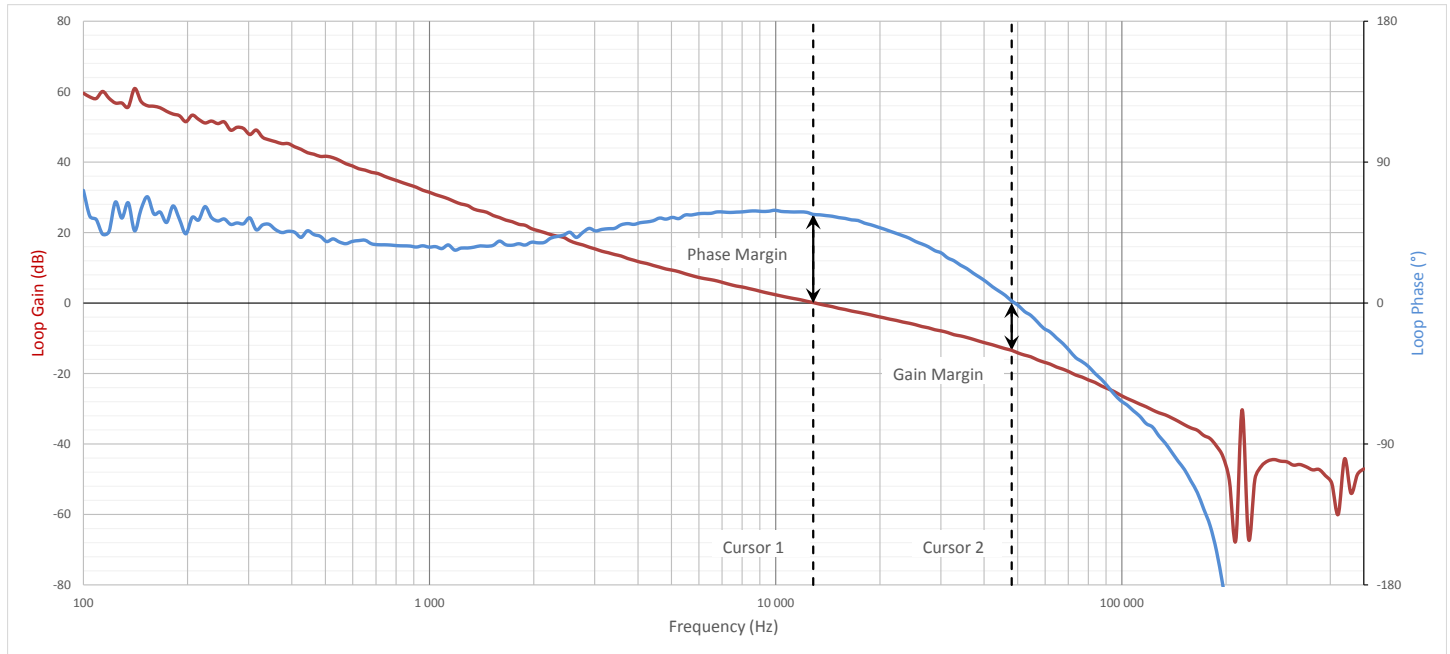

Figure 6.5. Si3404-Buck Non-Isolated EVB, 24 V, Class 3 PD Feedback Loop Measurement Results at Full Load

Table 6.2. Measured Loop Gain and Phase Margins

	Frequency	Gain	Phase
Cursor 1 (Phase Margin)	13 kHz	0 dB	56 °
Cursor 2 (Gain Margin)	49 kHz	-13.7 dB	0 °

6.7 Load Step Transient Measurement Results

The Si3404-Buck EVB board's output has been tested with a load step function to verify the converter's output dynamic response.

Load Step: from 0.05 to 0.45 A Output Current:
 $\Delta V_{OUT} = 480 \text{ mV}$

Load Step: from 0.45 to 0.05 A Output Current:
 $\Delta V_{OUT} = 390 \text{ mV}$

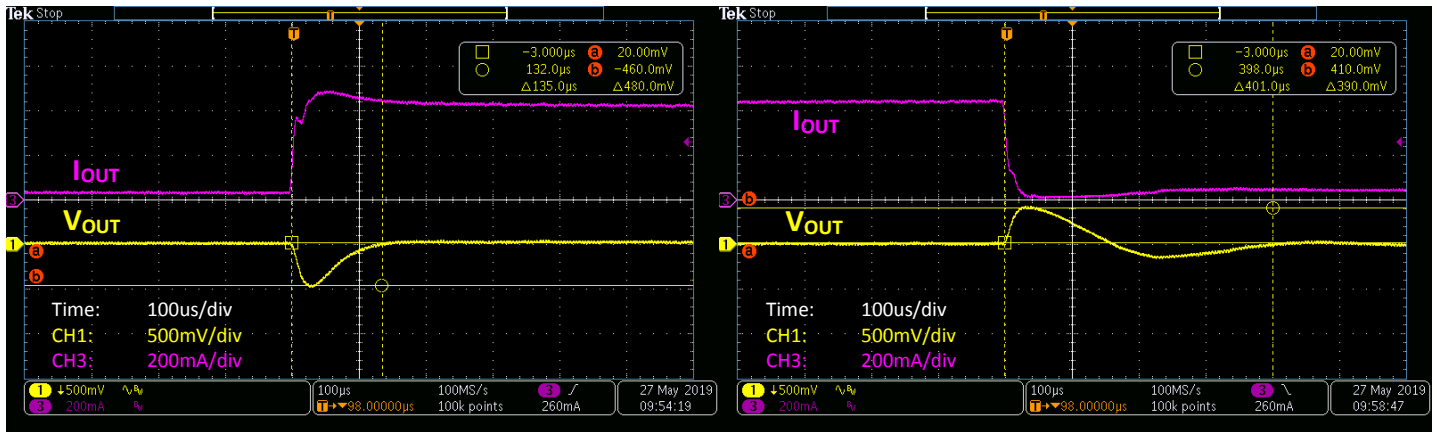

Figure 6.6. Si3404-Buck Non-Isolated EVB, 24 V, Class 3 PD Output Load Step Transient Test

6.8 Output Voltage Ripple

The Si3404-Buck EVB output voltage ripple has been measured in both no load and heavy load conditions.

No-Load V_{OUT} Ripple = 10.4 mV, No Pulse Skipping

Heavy-Load V_{OUT} Ripple = 20.8 mV

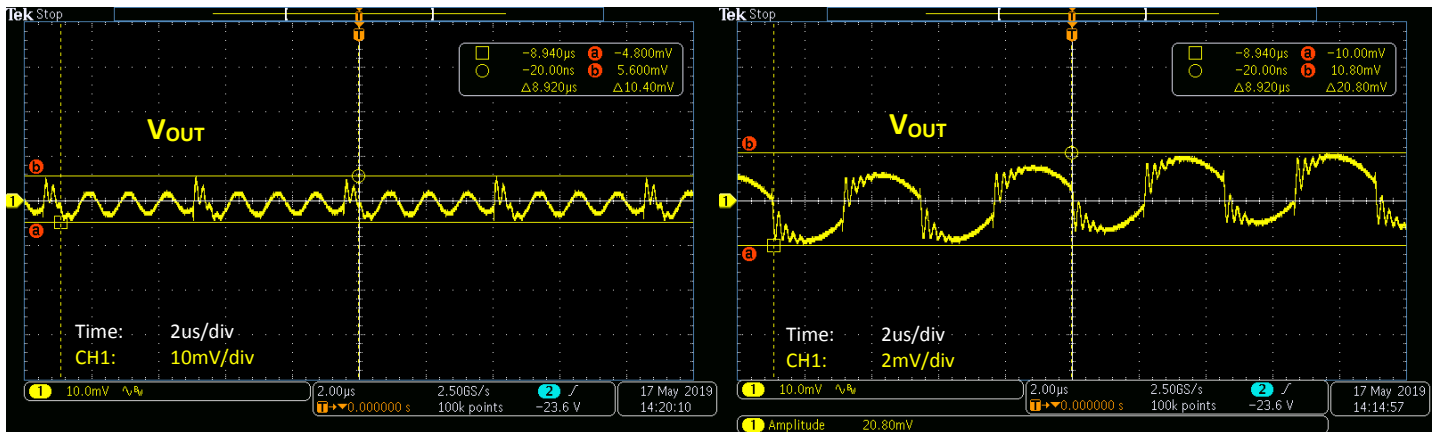

Figure 6.7. Si3404-Buck Non-Isolated EVB, 24 V, Class 3 Output Voltage Ripple No Load (Left) and Heavy Load (Right) Conditions

Note: The Si3404-Buck EVB in the 24 V configuration won't go into pulse skipping mode at no load condition, if the input voltage is higher than 42 V.

No-Load V_{OUT} Ripple = 96 mV, Pulse Skipping Present

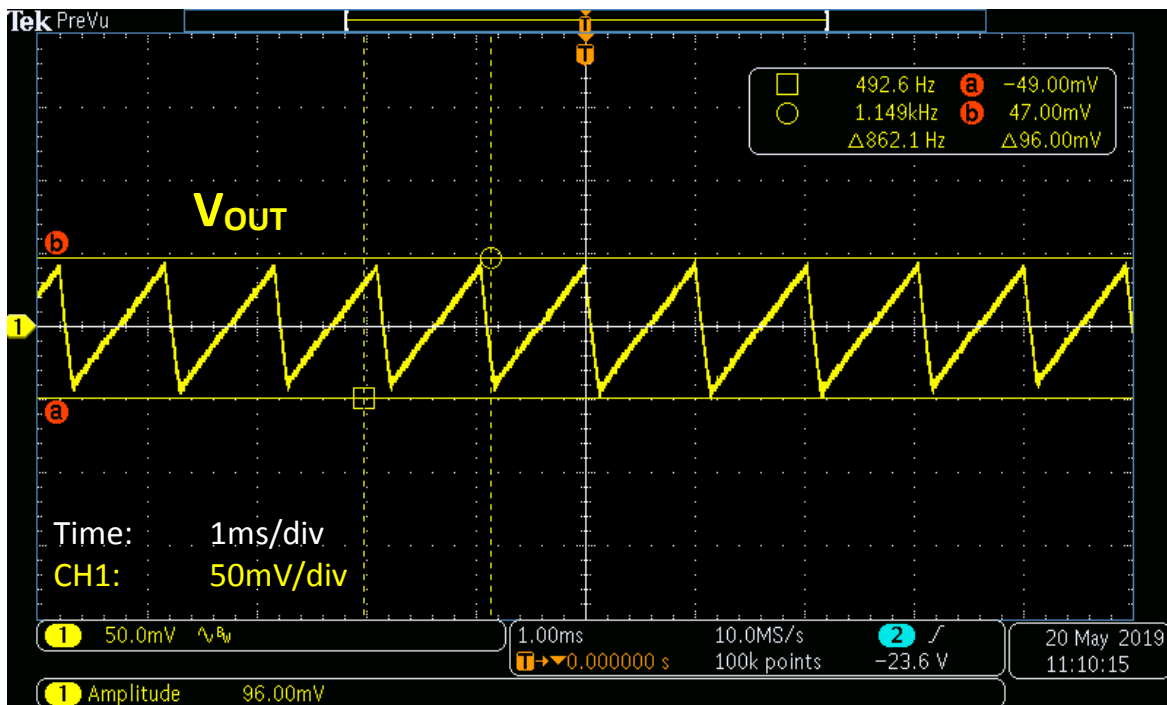

Figure 6.8. Si3404-Buck Non-Isolated EVB, 24 V, Class 3 Output Voltage Ripple No Load, Input Voltage: 42 V

6.9 Soft-Start Protection

The Si3404 device has an integrated dynamic soft-start protection mechanism to avoid stressing the components by the sudden current or voltage changes associated with the initial charging of the output capacitors.

The Si3404 intelligent adaptive soft-start mechanism does not require any external component to install. The controller continuously measures the input current of the PD and dynamically adjusts the internal IPEAK limit during soft-start, that way adjusting the output voltage ramping up time in a function of the attached load.

The controller lets the output voltage to rise faster in no load (or light load) condition. With heavy load at the output, the controller slows down the output voltage ramp to avoid exceeding the desired regulated output voltage value.

No-Load Soft Start:
 $t_{RISE} = 6.4 \text{ ms}$

Heavy-Load Soft Start:
 $t_{RISE} = 38.12 \text{ ms}$

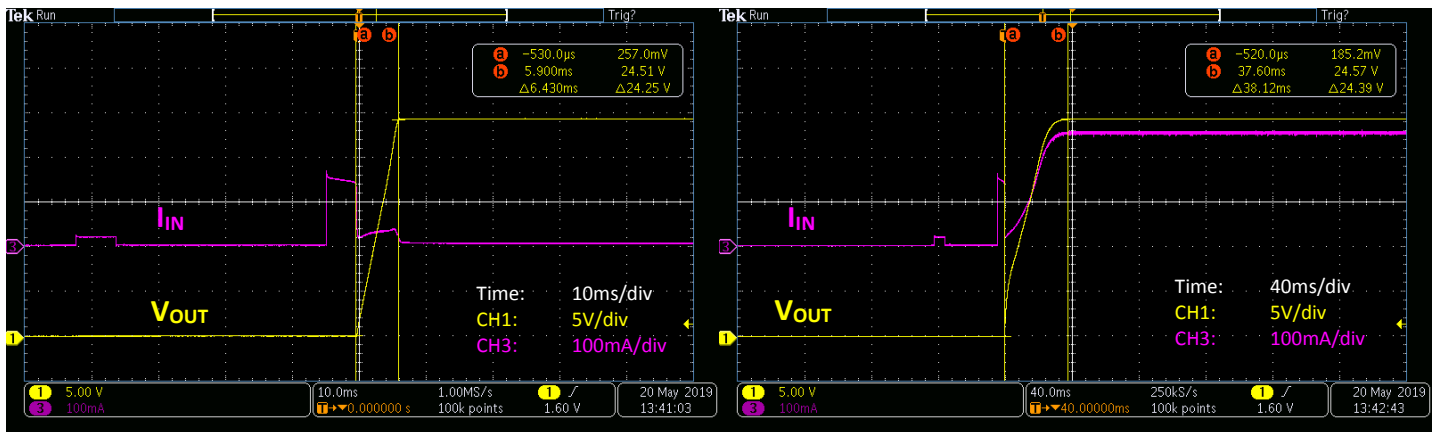

Figure 6.9. Si3404-Buck Non-Isolated EVB, 24 V, Class 3 Output Voltage Soft-Start at Low Load (Left) and Heavy Load (Right) Conditions

6.10 Output Short Protection

The Si3404 device has an integrated output short protection mechanism, which protects the IC itself and the surrounding external components from overheating in the case of electrical short on the output.

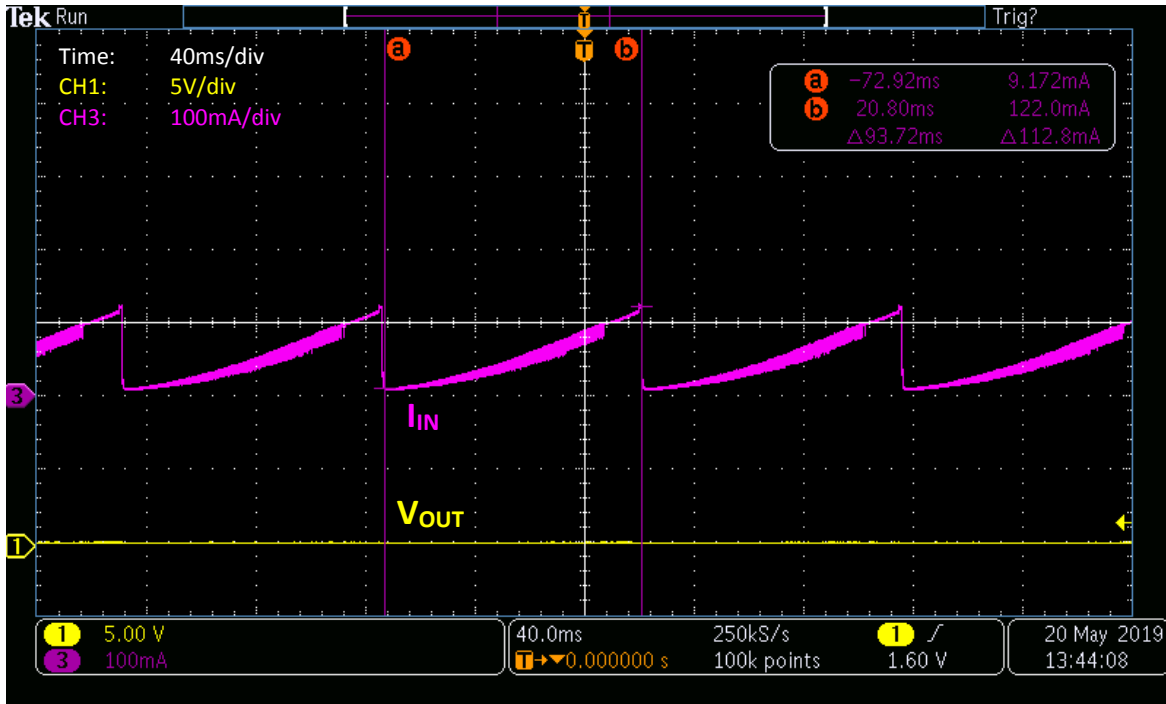

Figure 6.10. Si3404-Buck Non-Isolated EVB, 24 V, Class 3 Output Short Circuit Protection

6.11 Pulse Skipping at No-Load Condition

The Si3404 device has an integrated pulse skipping mechanism to ensure ultra-low power consumption under light load conditions.

As the output load decreases, the controller starts to reduce the pulse-width of the PWM signal (switcher ON time). At some point, even the minimum width pulse would provide higher energy than the application requires, which could result in loss of voltage regulation.

When the controller detects light load condition (which requires less ON time than the minimum pulse width), the controller enters into burst or light-load skipping mode. This mode is shown in the following figure by depicting the switching node of the integrated switching FET at no load condition.

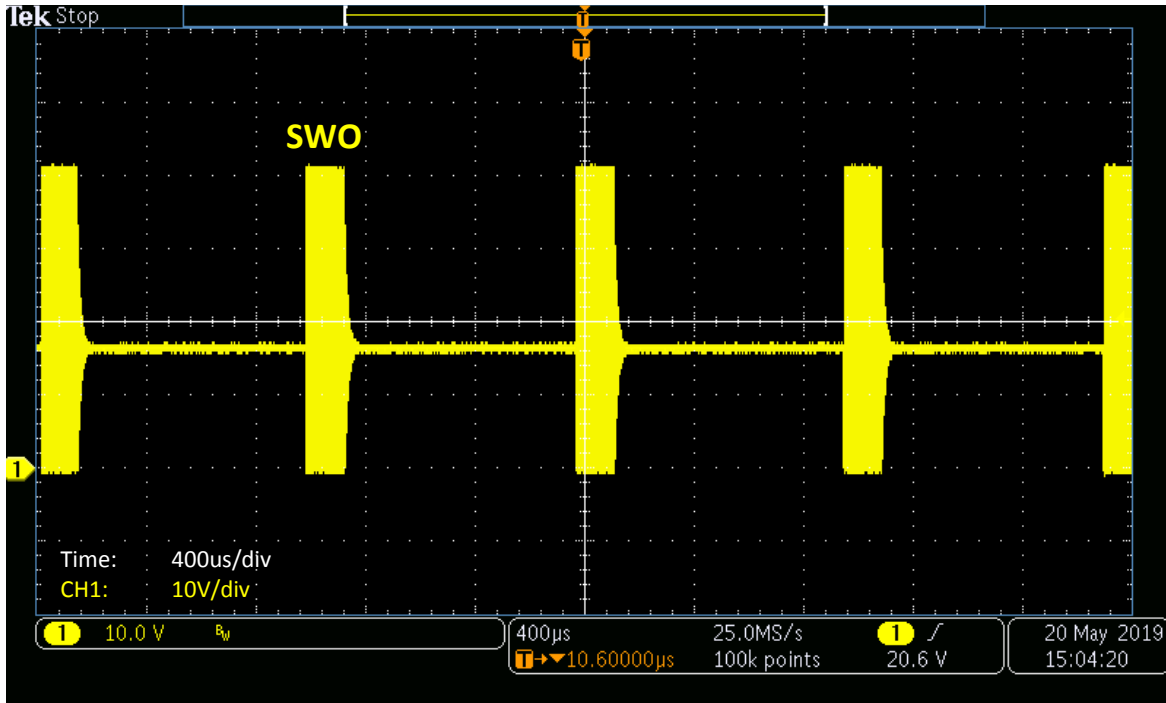

Figure 6.11. Si3404-Buck Non-Isolated EVB, 24 V, Class 3 Pulse Skipping at No-load Condition: SWO Waveform

Note: The Si3404-Buck EVB in the 24 V configuration won't go into pulse skipping mode at light load condition, if the input voltage is higher than 42 V.

6.12 Discontinuous (DCM) and Continuous (CCM) Current Modes

At low-load, the converter works in discontinuous current mode (DCM). At heavy load, the converter runs in continuous current mode (CCM). At low-load, the SWO voltage waveform has a ringing waveform, which is typical for a DCM operation.

Low-Load, DCM

Heavy-Load, CCM

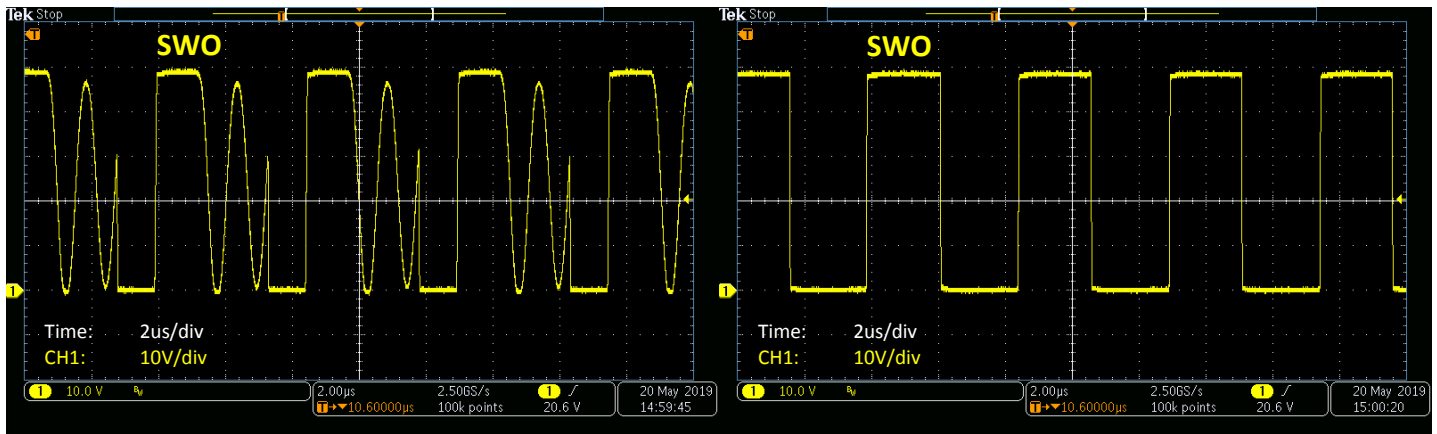

Figure 6.12. Si3404-Buck Non-Isolated, 24 V, Class 3 EVB: SWO Waveform in Discontinuous Current Mode (DCM) at Low Load (Left), and in Continuous Current Mode (CCM) at Heavy Load (Right)

6.13 Radiated Emissions Measurement Results

Radiated emissions have been measured of the Si3404-Buck 24 V, Class 3 EVB board with 50 V input voltage and full load connected to the output (13 W).

As shown below, the Si3404-Buck, 24 V, Class 3 EVB is fully compliant with the international EN 55032 Class B emissions standard.

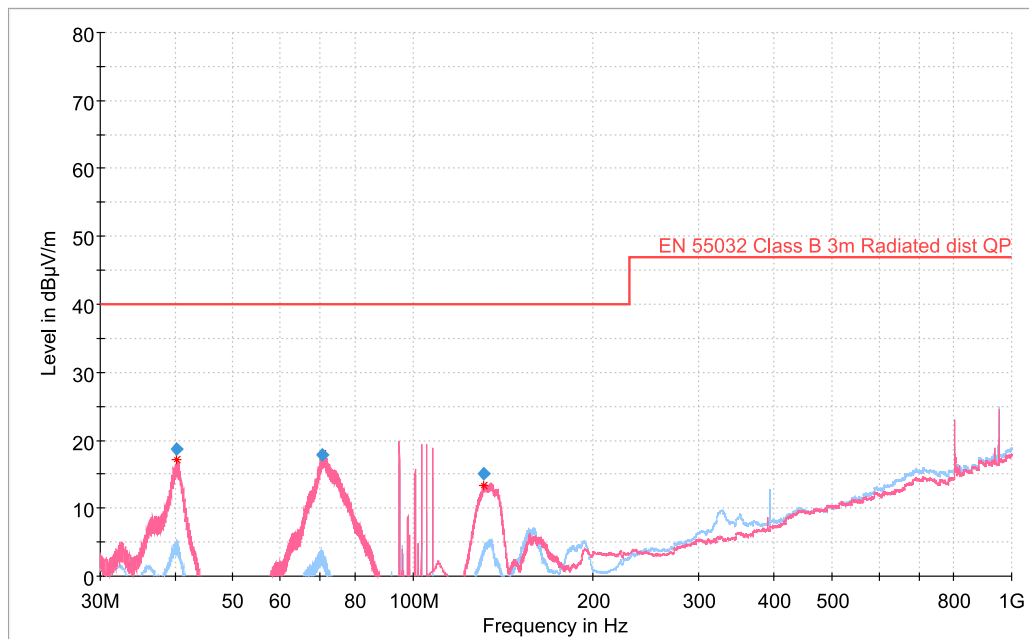

Figure 6.13. Si3404-Buck Non-Isolated EVB Radiated Emissions Measurements Results; 50 V Input, 24 V Output, 13 W Output Load

The EVB is measured at full load with peak detection in both vertical and horizontal polarizations. This is a relatively fast process that produces a red curve (vertical polarization) and a blue curve (horizontal polarization). Next, specific frequencies are selected (red stars) for quasi-peak measurements. The board is measured again at those specific frequencies with a quasi-peak detector, which is a very slow but accurate measurement. The results of this quasi-peak detector measurement are the blue rhombuses.

The blue rhombuses represent the final result of the measurement process. To have passing results, the blue rhombuses should be below the highlighted EN 55032 Class B limit.

6.14 Conducted Emissions Measurement Results

The Si3404-Buck, 24 V, Class 3 EVB board's conducted emissions have been measured in two different measurement methods to comply with the international EN 55032 standard. The EVB is supplied and measured on its PoE input port as shown in the following figure.

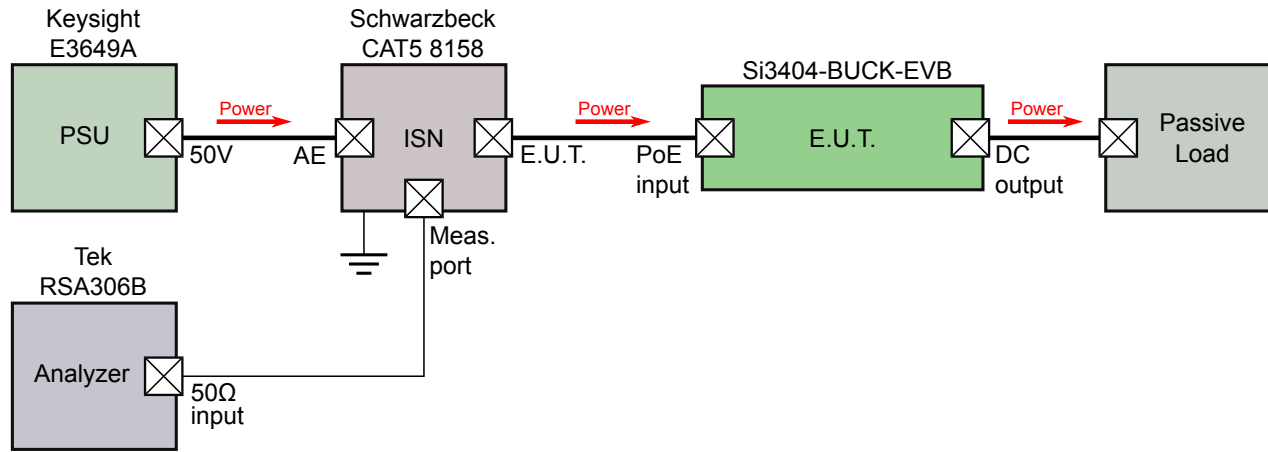

Figure 6.14. Conducted EMI Measurement Setup

The detector in the spectrum analyzer is set to:

- Peak detector and
- Average detector

Both results are shown in the following figure.

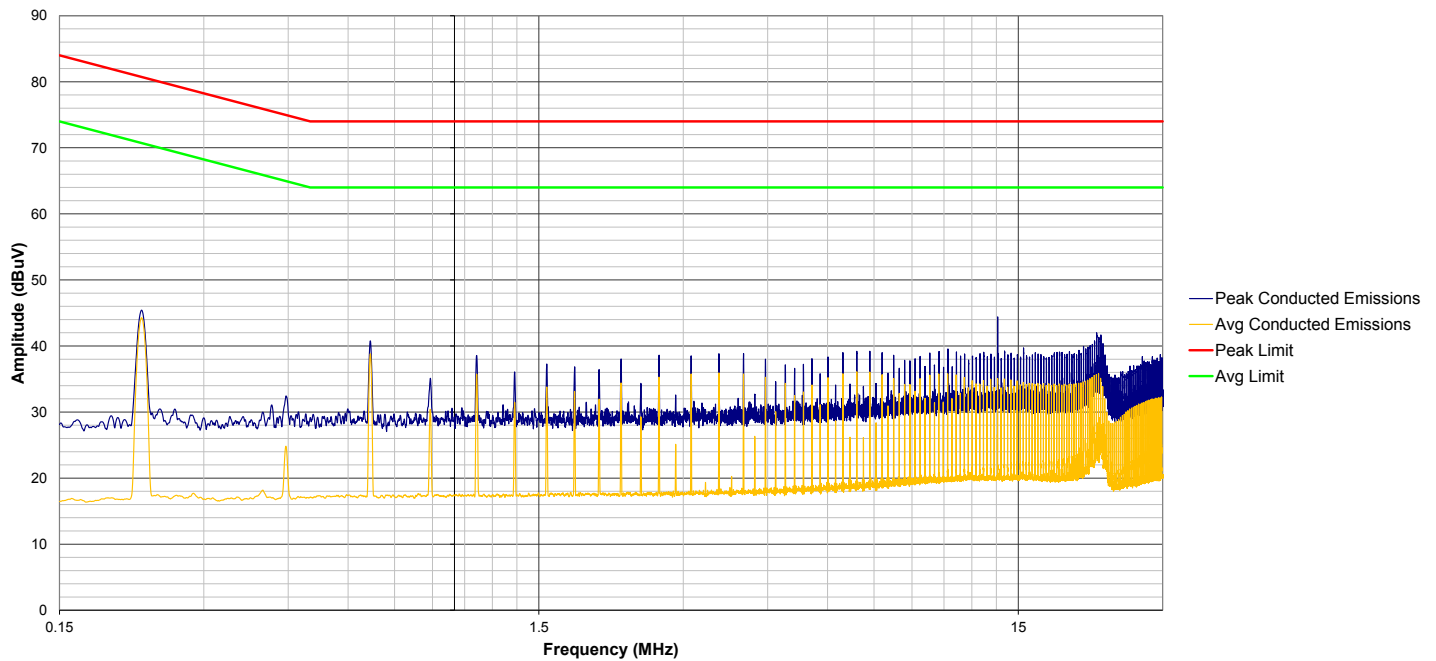

Figure 6.15. Si3404-Buck Non-Isolated EVB Conducted Emissions Measurements Results; 50 V Input, 24 V Output, 13 W Output Load

6.15 Bill of Materials

The following table is the BOM listing for the standard 24 V output evaluation board with option PoE Class 3.

Table 6.3. Si3404-Buck 24 V Bill of Materials

Designator	Quantity	Description	Manufacturer	Manufacturer Part Number
C1	1	CAP, 1 μ F, 100 V, \pm 10%, X7R, 1210	Venkel	C1210X7R101-105K
C13	1	CAP, 0.1 μ F, 100 V, \pm 10%, X7R, 0805	Venkel	C0805X7R101-104K
C14	1	CAP, 470 pF, 50 V, \pm 1%, C0G, 0805	Venkel	C0805C0G500-471F
C19	1	CAP, 0.1 μ F, 16 V, \pm 10%, X7R, 0805	Venkel	C0805X7R160-104K
C2	1	CAP, 12 μ F, 100 V, \pm 20%, AL, 6.3 x 11.2 mm	Panasonic	EEUFC2A120
C4 C5 C8	3	CAP, 22 μ F, 25 V, \pm 10%, X7R, 1210	Venkel	C1210X7R250-226M
C7	1	CAP, 1 μ F, 50 V, \pm 10%, X7R, 0805	Samsung	CL21B105KBFNNNE
D1	1	DIO, Schottky, 100 V, 3 A, PowerDI-5	Diodes Inc.	PDS3100-13
D2, D3, D4, D5, D7, D8, D9, D10	8	DIO, Single, 100 V, 1.0 A, SMA	Fairchild	S1B
J1	1	CONN, RJ-45, MAGJACK, 1 Port PoE	Bel	SI-52003-F
J2 J3	2	CONN, Banana Jack, Threaded un-insulated	Abbatron HH Smith	101
L1 L3	2	Ferrite Bead, 700 Ω @150MHZ, 0805	Würth	742792040
L2	1	Inductor, Power, Shielded, 270 μ H, \pm 10%, 0.66 A, SMD	Coilcraft	MSS1038-274KL
R1	1	RES, 7.5 k Ω , 1/10 W, \pm 1%, ThickFilm, 0805	Venkel	CR0805-10W-7501F
R10	1	RES, 88.7 k Ω , 1/8 W, \pm 1%, ThickFilm, 0805	Vishay	CRCW080588K7FKEA
R11	1	RES, 48.7 Ω , 1/8 W, \pm 1%, ThickFilm, 0805	vishay	CRCW080548R7FKTA
R3	1	RES, 1.37 k Ω , 1/10 W, \pm 25 PPM, \pm 0.1%, ThinFilm, 0805	Venkel	TFCR0805-10W-E-1371B
R4	1	RES, 23.7 k Ω , 1/10 W, \pm 25 PPM, \pm 0.1%, ThinFilm, 0805	Venkel	TFCR0805-10W-E-2372B
R5	1	RES, 10 Ω , 1/10 W, \pm 1%, ThickFilm, 0805	Venkel	CR0805-10W-10R0F
R6	1	RES, 3 Ω , 1/8 W, \pm 1%, ThickFilm, 0805	Venkel	CR0805-8W-3R00FT
R7	1	RES, 0.62 Ω , 1/8 W, \pm 1%, ThickFilm, 0805	Yageo	RL0805FR-070R62L
R8	1	RES, 100 k Ω , 1/8 W, \pm 1%, ThickFilm, 0805	Venkel	CR0805-8W-1003F
R9	1	RES, 24.3 k Ω , 1/8 W, \pm 1%, ThickFilm, 0805	vishay	CRCW080524K3FKEA
TP1, TP2, TP11, TP12	4	Testpoint, Black, 0.050" Loop, PTH	Keystone	5001

Designator	Quantity	Description	Manufacturer	Manufacturer Part Number
U1	1	IC, Fully-Integrated 802.3-Compliant PoE PD Interface and Low-EMI Switching Regulator, QFN20	Silicon Labs	Si3404-A-GM
Not-Installed Components				
C20	1	CAP, 330 pF, 50 V, ±1%, C0G, 0805	Venkel	C0805C0G500-331F
C3	1	CAP, 35 V, ±20%, AL, 8.0 x 11.5 mm		
C6	1	CAP, 50 V, ±10%, X7R, 0805		
C9, C10, C11, C12, C15, C16, C17, C18	8	CAP, 1 nF, 100 V, ±10%, X7R, 0603	Venkel	C0603X7R101-102K
D6	1	DIO, TVS, UNIDIR, 58 V, 400 W	Littelfuse	SMAJ58A
R2	1	RES, 1 kΩ, 1/10 W, ±1%, ThickFilm, 0805	Venkel	CR0805-10W-1001F
TP3, TP4, TP5, TP6, TP7, TP8, TP9, TP10	8	Testpoint, Black, 0.050" Loop, PTH	Keystone	5001

7. Tunable Switching Frequency

The switching frequency of the oscillator is selected by choosing an external resistor (R_{FREQ}) connected between the RFREQ and VPOS pins. The following figure will aid in choosing the R_{FREQ} value to achieve the desired switching frequency.

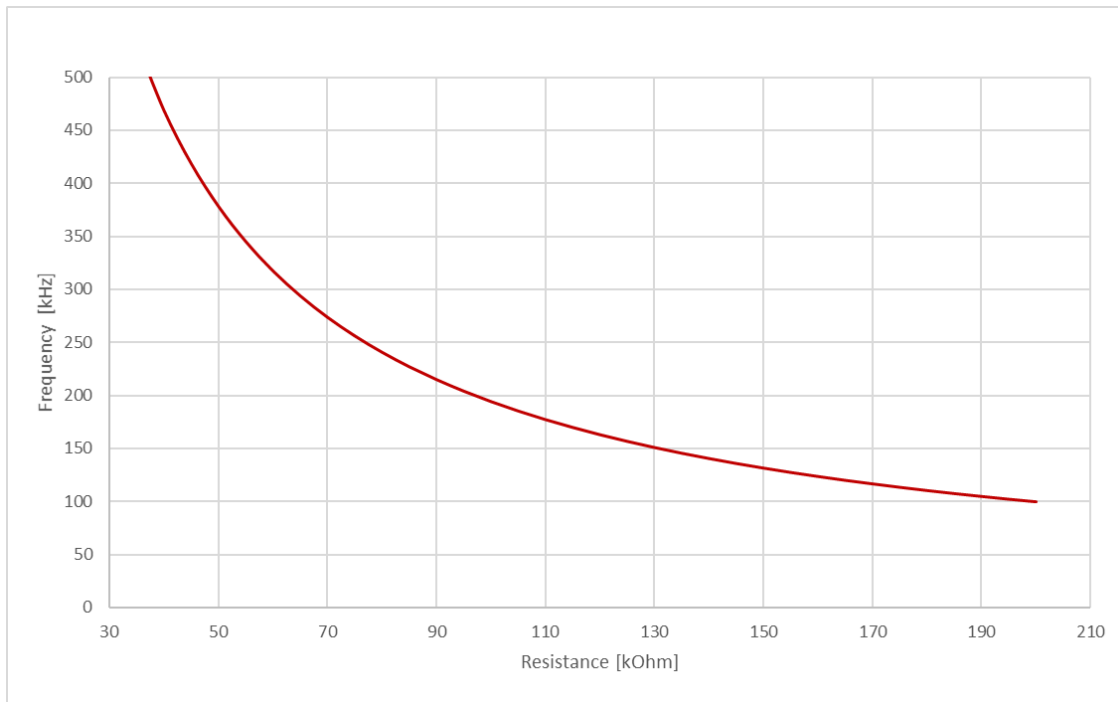

Figure 7.1. Switching Frequency vs R_{FREQ}

The selected switching frequency for this application is 220 kHz, which is achieved by setting the R_{FREQ} resistor to 88.7 k Ω .

8. Board Layout

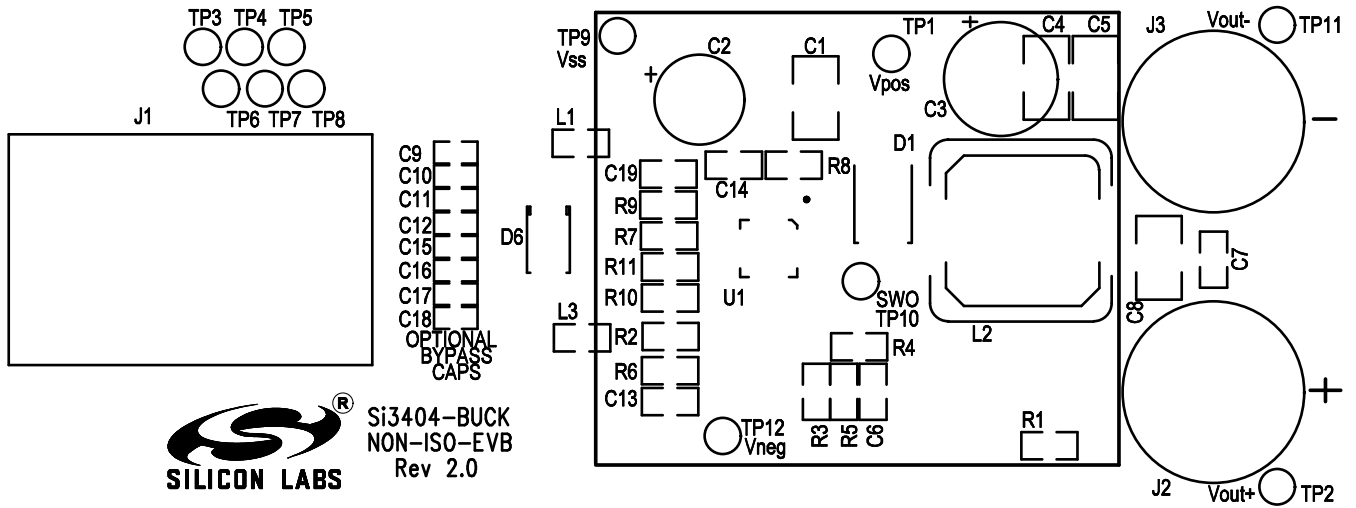

Figure 8.1. Top Silkscreen

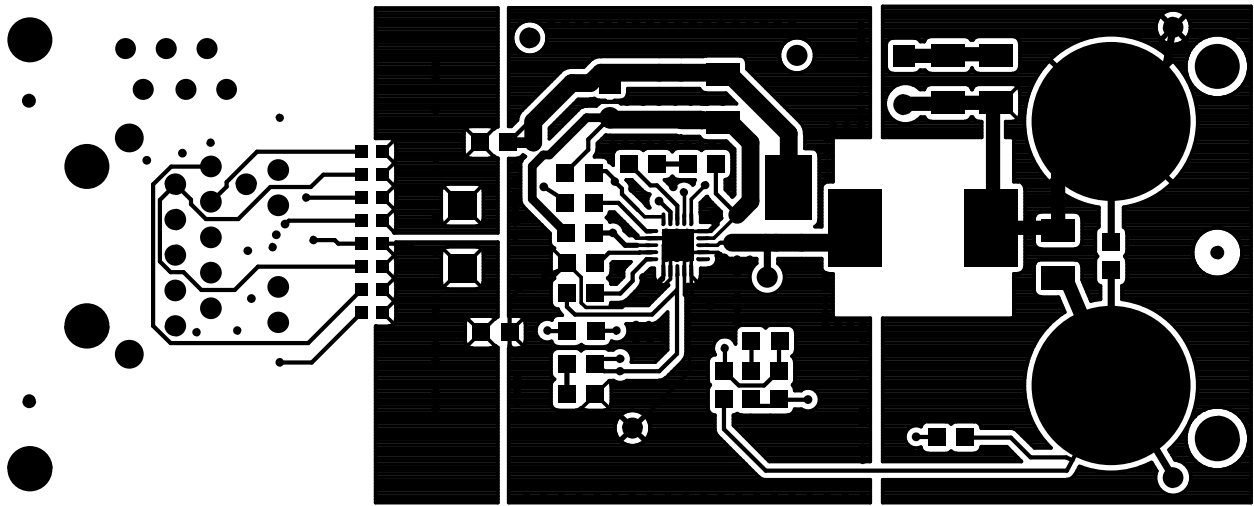

Figure 8.2. Top Layer

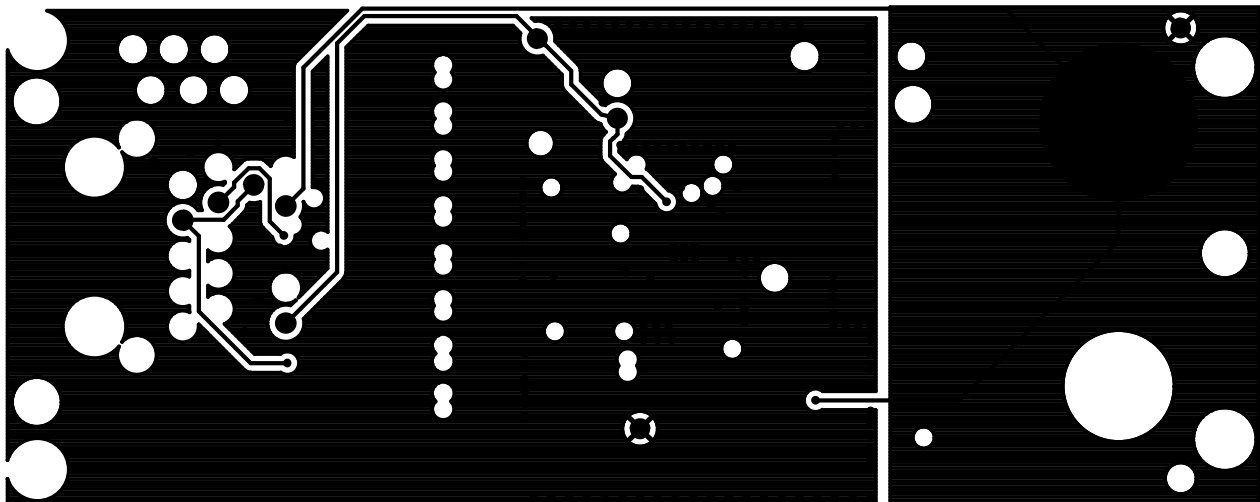

Figure 8.3. Internal 1 (Layer 2)

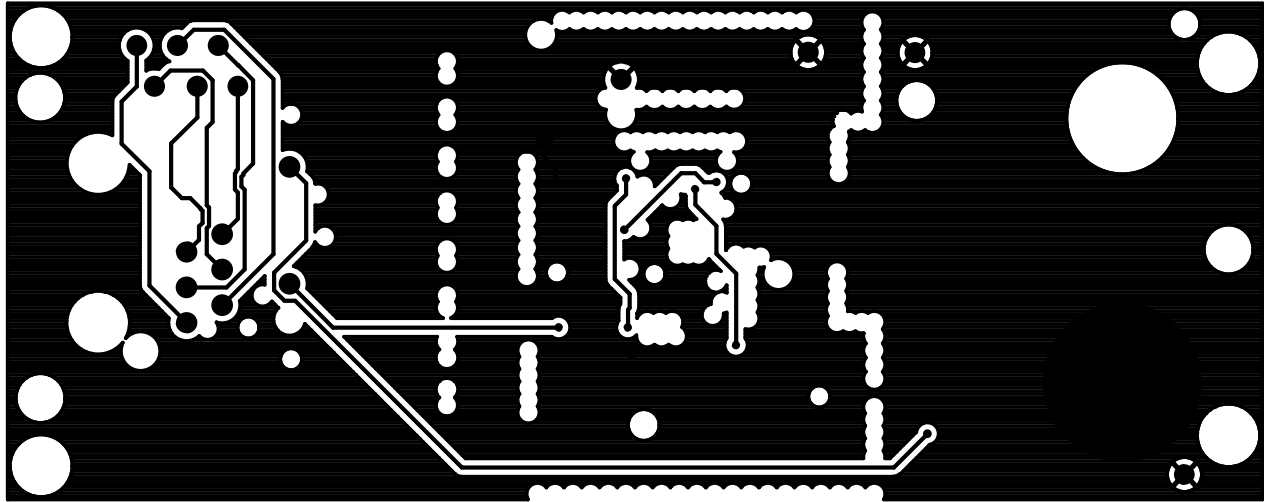

Figure 8.4. Internal 2 (Layer 3)

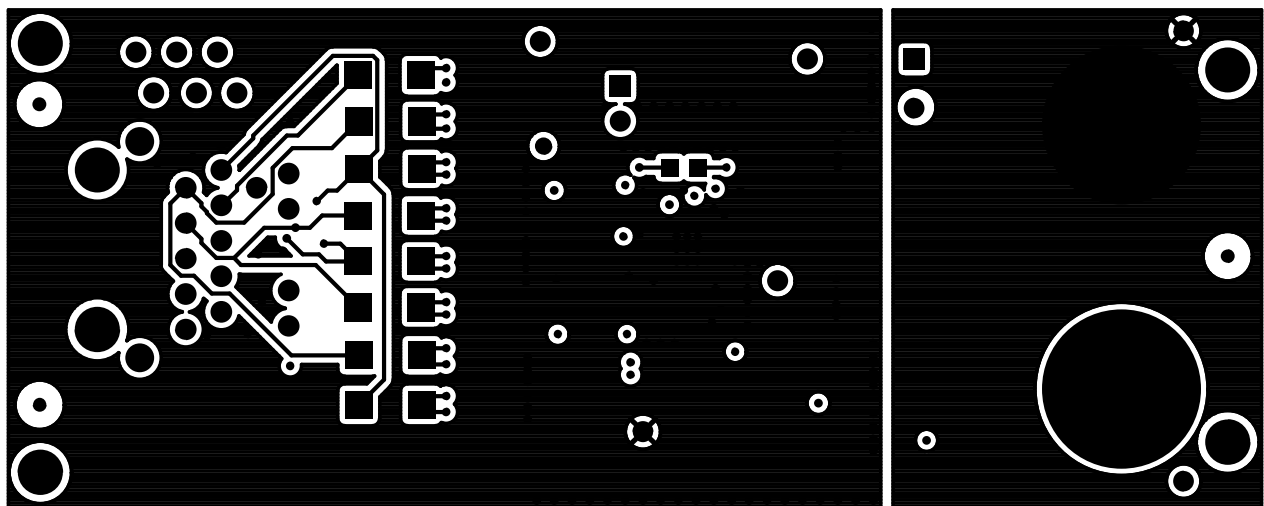

Figure 8.5. Bottom Layer

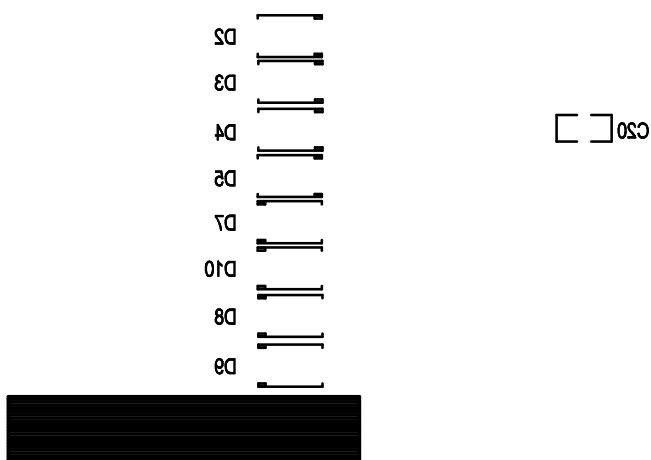

Figure 8.6. Bottom Layer

9. Appendix—Si3404 Buck Design and Layout Checklist

The complete EVB design databases for the four configurations are located at www.silabs.com/PoE. Silicon Labs strongly recommends using these EVB schematics and layout files as a starting point to ensure robust performance and avoid common mistakes in the schematic capture and PCB layout processes.

The following is a recommended design checklist that can assist in trouble-free development of robust PD designs.

Refer also to the Si3404 data sheet and AN1130 when using the following checklist.

1. Design Planning Checklist:

- a. Determine if your design requires an isolated or non-isolated topology. For more information, see AN1130.
- b. Silicon Labs strongly recommends using the EVB schematics and layout files as a starting point as you begin integrating the Si3404-BUCK into your system design process.
- c. Determine your load's power requirements (i.e., VOUT and IOUT consumed by the PD, including the typical expected transient surge conditions). In general, to achieve the highest overall efficiency performance of the Si3404-BUCK, choose the highest output voltage option used in your PD and then post regulate to the lower supply rails, if necessary.
- d. Based on your required PD power level, select the appropriate class resistor RCLASS value by referring to AN1130.

2. General Design Checklist:

- a. Non-standard PoE injectors turns on the PD without detection and classification phases. In most cases, dV/dt is not controlled and could violate IEEE requirements. To ensure robustness with those injectors, please include a $3\ \Omega$ resistors in series with C13.
- b. Silicon Labs recommends the inclusion of a minimum load (250 mW) to avoid the PSE port being disconnected by the PSE. If your load is not at least 250 mW, add a resistor load to dissipate at least 250 mW.

3. Layout Guidelines:

- a. Make sure VNEG pin of the Si3404 is connected to the backside of the QFN package with an adequate thermal plane.
- b. Keep the trace length from SWO to VSS as short as possible. Make all of the power (high current) traces as short, direct, and thick as possible. It is a good practice on a standard PCB board to make the traces an absolute minimum of 15 mils (0.381 mm) per ampere.
- c. Usually, one standard via handles 200 mA of current. If the trace needs to conduct a significant amount of current from one plane to the other, use multiple vias.
- d. Keep the circular area of the loop from the Switcher FET output to the inductor and returning from the input filter capacitors (C1–C2) to VSS as small a diameter as possible. Also, minimize the circular area of the loop from the output of the inductor to the Schottky diode and returning through the output filter capacitor back to the inductor as small as possible. If possible, keep the direction of current flow in these two loops the same.
- e. Keep the high-power traces as short as possible.
- f. Keep the feedback and loop stability components as far from the inductor and noisy power traces as possible.
- g. If the outputs have a ground plane or positive output plane, do not connect the high current carrying components and the filter capacitors through the plane. Connect them together, and then connect to the plane at a single point.

To help ensure first-pass success, contact our customer support by submitting a help ticket and uploading your schematics and layout files for review.