



UG443: Si3406 Isolated Flyback EVB User Guide

Description

The Si3406 isolated Flyback evaluation board is a reference design for a power supply in a Power over Ethernet (PoE) Powered Device (PD) application.

This Si3406-Flyback EVB provides simple and low-cost solution with different output voltages and power levels.

The Si3406-ISO-FB-EVB board is shown below. The Si3406 IC integrates an IEEE 802.3at compatible PoE interface as well as a current control-based dc/dc converter.

The Si3406 PD integrates an internal rectifier bridge, detection circuit, classification circuit, dc/dc switch, hotswap switch, TVS overvoltage protection, dynamic soft-start circuit, cycle-by-cycle current limit, thermal shutdown, optional synchronous secondary rectification driver, automatic and user mode MPS generation, and inrush current protection.

The switching frequency is set to 177 kHz, 150 kHz and 123 kHz for 3.3 V, 5 V and 12 V, respectively, by installing R18 with 110 kΩ, 130 kΩ and 160 kΩ for the different voltage levels.

Features

- IEEE 802.3at compliant
- Very small application PCB surface
- High efficiency
- High integration
- Low-profile 4 x 4 mm 20-pin QFN
- Integrated diode bridge
- Integrated thermal shutdown protection
- Low BOM Cost
- Automatic and user mode MPS generation
- Integrated transient overvoltage protection

Parameter	Condition	Specifications		
		Si3406FB3V2KIT	Si3406FB5V2KIT	Si3406FB12V2KIT
Ordering Part Number	—	Si3406FB3V2KIT	Si3406FB5V2KIT	Si3406FB12V2KIT
PSE input voltage range	Connector J1	37 V to 57 V		
PoE Type/Class	IEEE 802.3at	Type 1/Class 2		
Output Voltage / Current	Connectors J2-J3	3.3 V / 1.5 A	5 V / 1.05 A	12 V / 0.45 A
Efficiency, End-to-End	VIN = 50 V, internal bridge	77.8 %	80.3 %	83.1%
Efficiency, End-to-End	VIN = 50 V, internal bridge w/ SYNC	79.3 %	82.0 %	84.0 %
Efficiency, End-to-End	VIN = 50 V, external silicon bridge	78.2 %	80.7 %	83.5 %
Switching frequency	RFREQ (R18)	177 kHz (110 kΩ)	150 kHz (130 kΩ)	123 kHz (160 kΩ)
Conducted EMI	EN55032, average detector	Passed		
Conducted EMI	EN55032, peak detector	Passed		
Radiated EMI	EN55032 Class B	Passed		

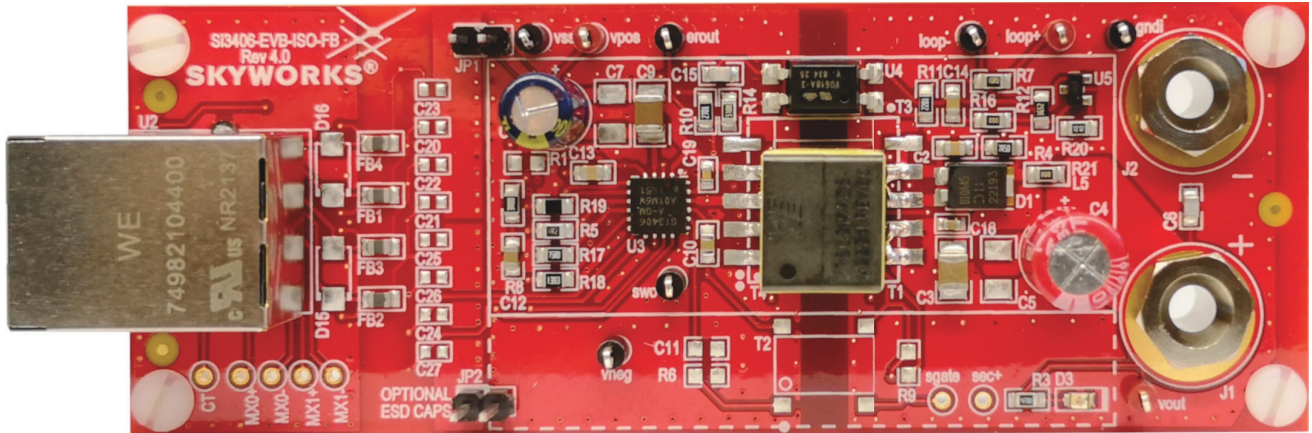

Figure 1. Si3406 Isolated Flyback Evaluation Board

1. Selector Guide

The output voltage of this isolated flyback evaluation board depends mainly on the turns ratio of the flyback transformer. With an adequate transformer, it is possible to generate any kind of output voltage.

This user guide presents three different output voltages: 3.3 V, 5 V, and 12 V.

The maximum input power allowed by the standard is 6.49 W, but the EVB can handle up to 7 W output power, which is limited by the internal rectifier bridge, while the efficiency of the EVB highly depends on the output voltage. Higher output voltage configurations tend to have higher efficiency, meanwhile, lower output voltage configurations have lower efficiency.

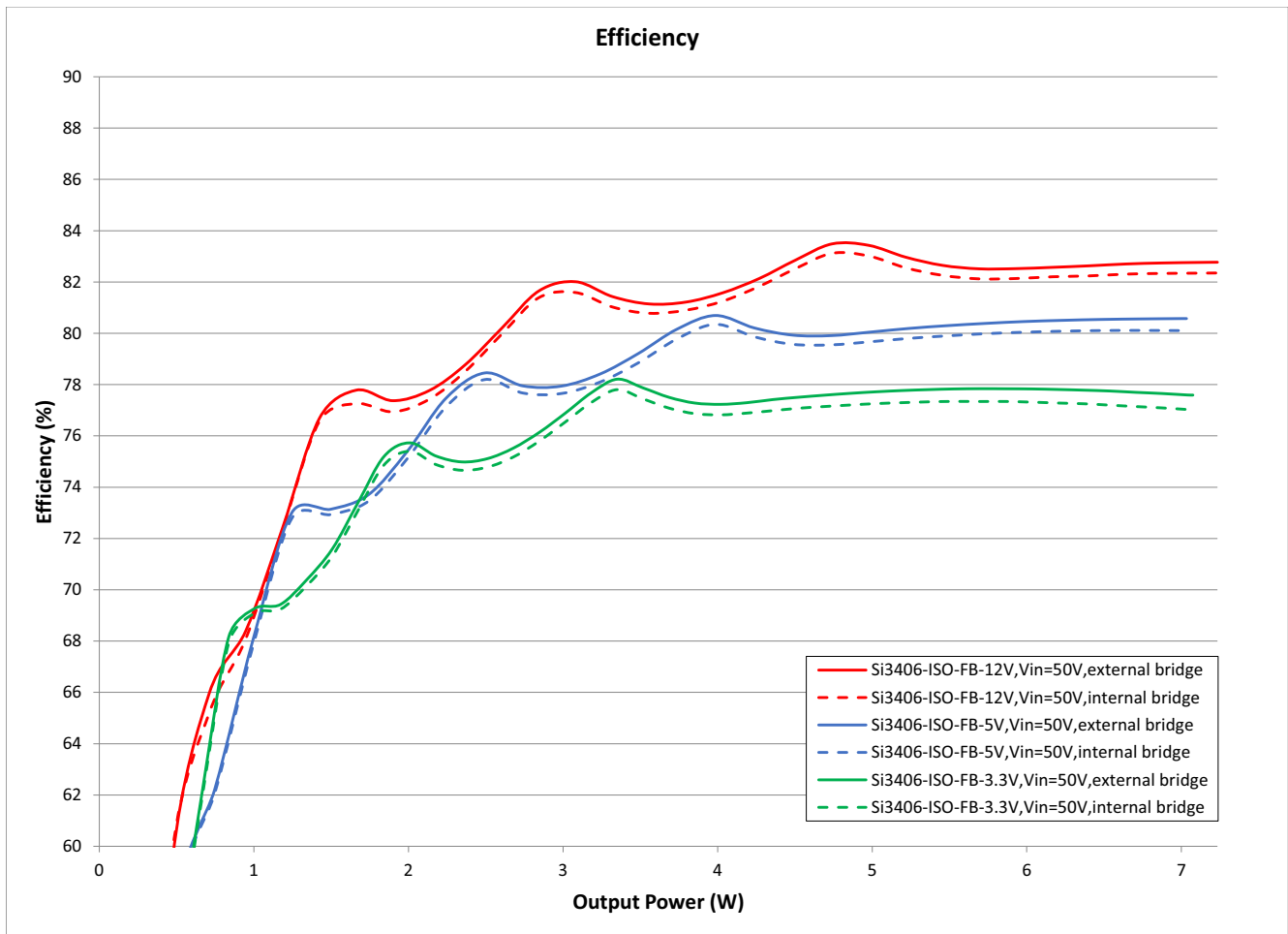

Figure 2. Si3406-Flyback Isolated EVB End-to-End Efficiency of Different Configurations: 50 V Input

Note: The chart shows the end-to-end EVB efficiency, where voltage drop on the diode bridge is included while indicator LEDs are removed as they are not part of the power conversion.

The standard Si3406-ISO-FB EVB is shown on the cover page. This document includes complete schematics and measurement data for the below three different output voltages:

- Si3406-ISO-FB-3.3V-7W – Class 2
- Si3406-ISO-FB-5V-7W – Class 2
- Si3406-ISO-FB-12V-7W – Class 2

The parts in red on the schematics represent the BOM differences between the three designs, while the parts in grey are the not installed/optional parts in the design.

The boards are shipped with external silicon diode bridges installed but they are not connected. If higher efficiency is needed or >10 W capable XFMRs are validated with the dual footprint, the external silicon diodes (S1B) shall be connected by populating the JP1 and JP2 jumpers. Schottky diodes can be used too as external diode bridges, in this case SS2150 are recommended. See Figure 2, “Si3406-Flyback Isolated EVB End-to-End Efficiency of Different Configurations: 50 V Input,” on page 3 for overall conversion efficiency results.

On the board, the internal diode bridges are used as rectifier bridges by default. The recommended detection resistor values are listed in the following table respective to the diode bridges used:

Table 1. Recommended Detection Resistor Values

Diode Bridge	R _{DET}
Internal	24.3 kΩ
External silicon	24.3 kΩ
External Schottky	24.9 kΩ

2. Powering Up the Si3406-ISO-FB Board

Ethernet data and power are applied to the board through the RJ45 connector (U2). The board itself has no Ethernet data transmission functionality, but, as a convenience, the Ethernet with secondary-side data is brought out to test points.

The design can be used in Gigabit (10/100/1000) systems as well by using PoE RJ45 Magjack, such as type 7499511001A from Würth Elektronik.

Power may be applied in the following ways:

- Using any IEEE 802.3-2015-compliant, PoE-capable PSE, or
- Using a laboratory power supply unit (PSU):
 - Connecting a dc source between blue/white-blue and brown/white-brown of the Ethernet cable (either polarity, Endspan) as shown below:

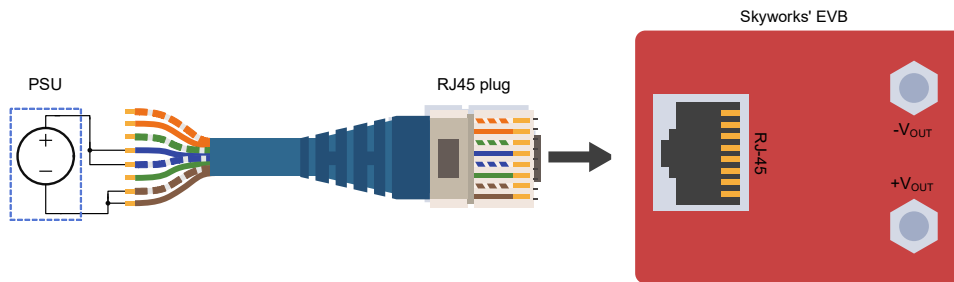

Figure 3. Endspan Connection Using Laboratory Power Supply

- Connecting a dc source between green/white-green and orange/white-orange of the Ethernet cable (either polarity, Midspan) as shown below:

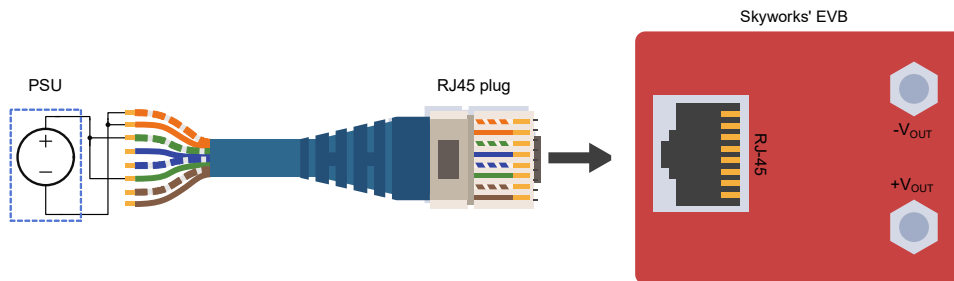

Figure 4. Midspan Connection Using Laboratory Power Supply

3. Si3406-ISO-FB EVB: 3.3 V, Class 2 Configuration

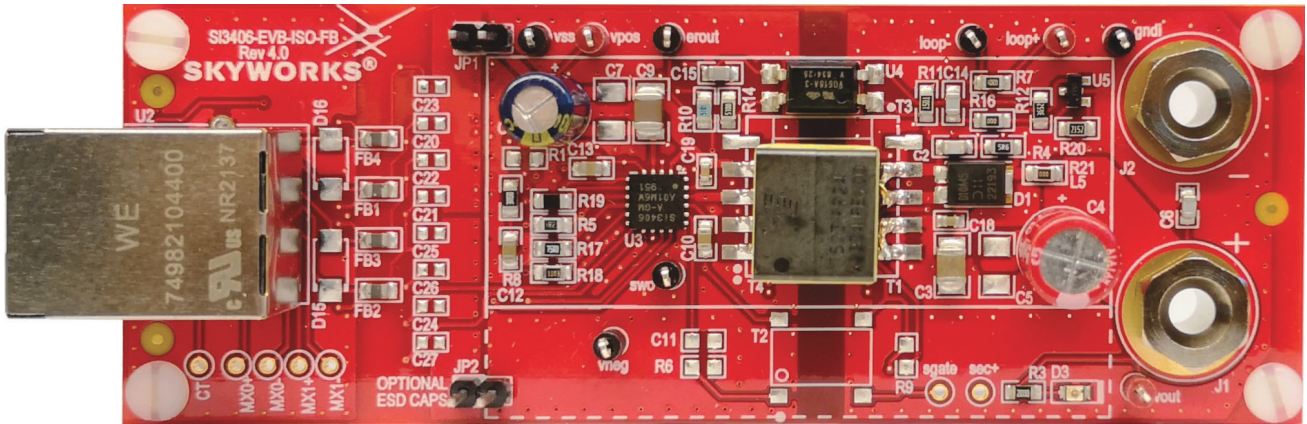

Figure 5. Si3406-ISO-FB EVB 3.3 V Board

3.1. Si3406-ISO-FB EVB Schematic: 3.3 V, Class 2, 7W

Figure 6 shows the schematic of the Si3406-ISO-FB 3.3 V, Class 2 EVB. The parts in red on the schematic represent the BOM differences compared to the other output voltage variants of this EVB. The parts in gray are not installed on the EVB, but they have footprints.

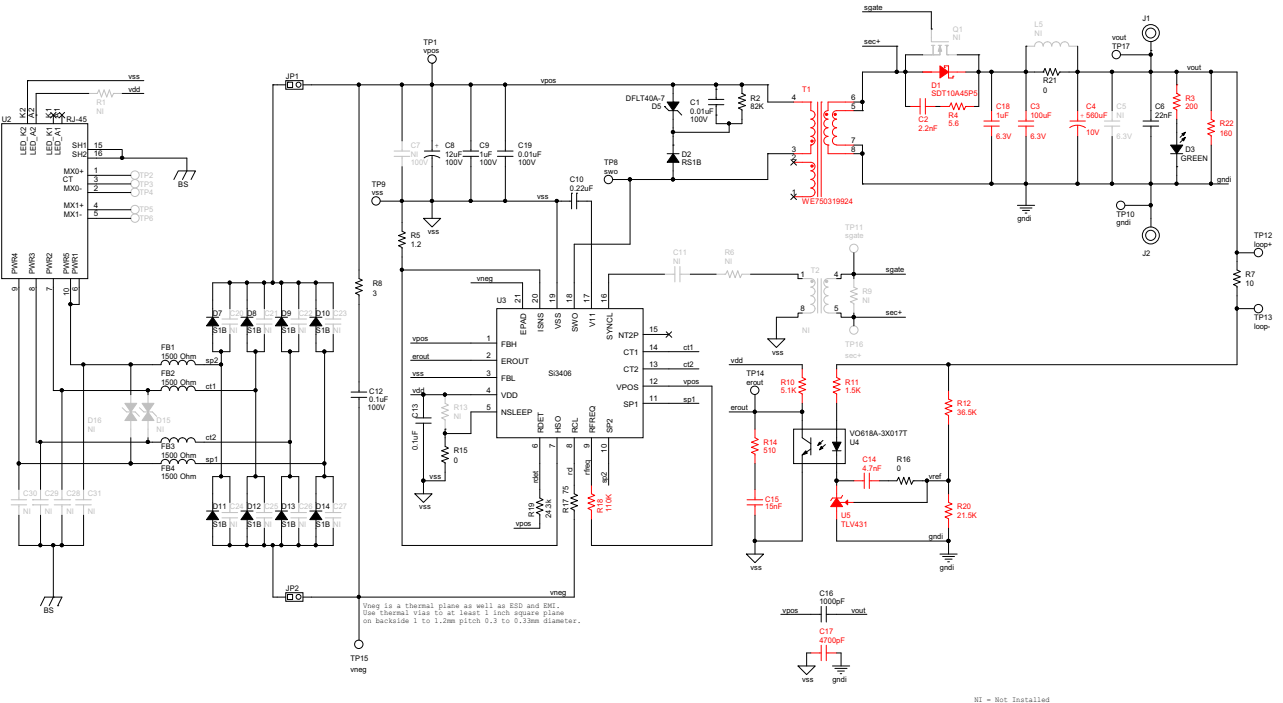

Figure 6. Si3406-ISO-FB Isolated EVB Schematic: 3.3 V, Class 2 PD, 7W

3.2. End-to-End EVB Efficiency

The end-to-end conversion efficiency measurement data of the Si3406 3.3 V ISO-FB board is shown in the figure below with internal and external (S1B) input bridges. Efficiency was measured from PoE (RJ45 connector) input to the 3.3 V output. The efficiency was measured at three different input voltage levels: 40.8 V, 50 V, and 57 V.

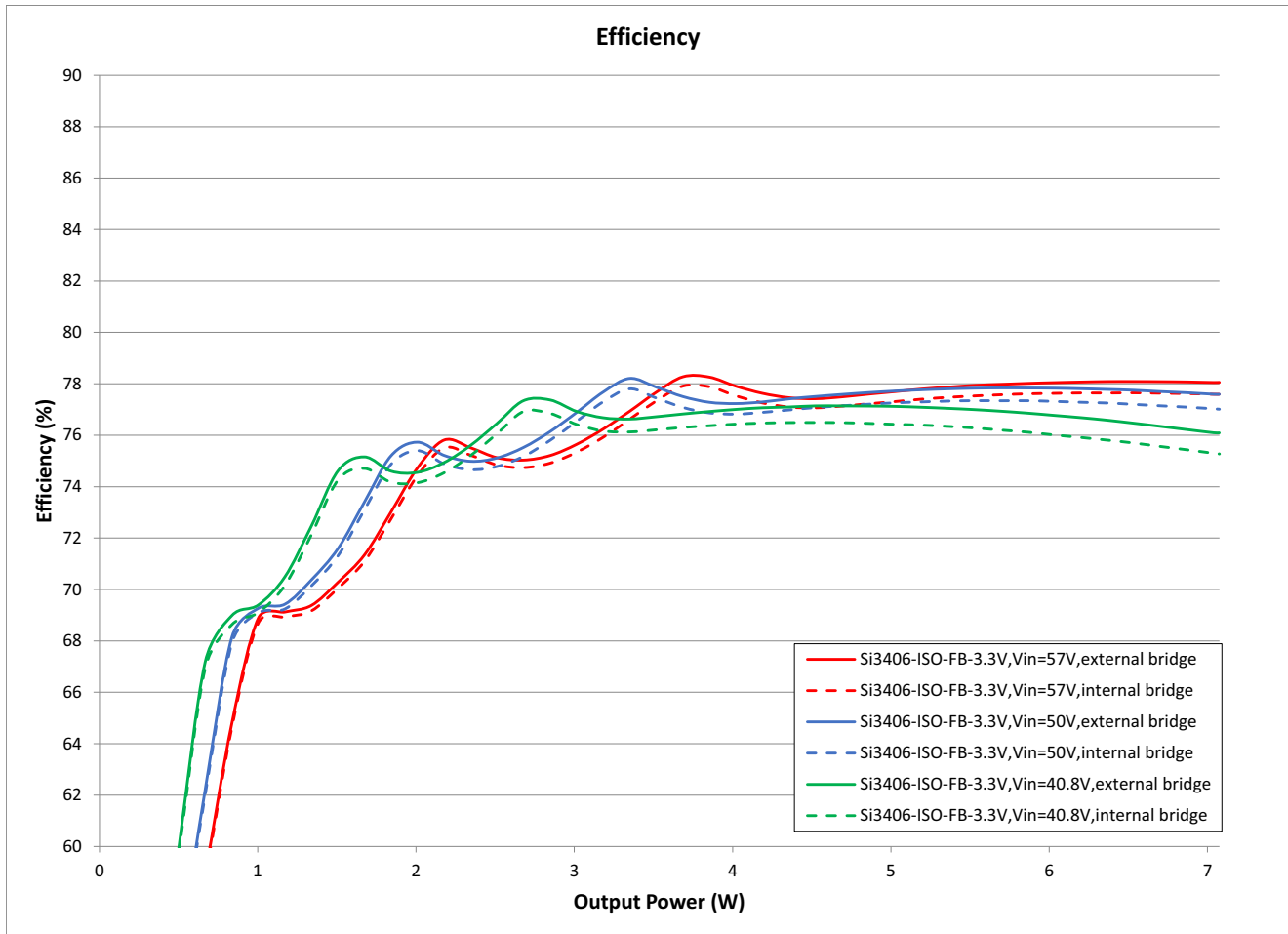

Figure 7. Si3406-ISO-FB End-to-End Efficiency Chart with Internal and External (S1B) Input Bridge Diodes: 40.8 V, 50 V and 57 V Input, 3.3 V Output, Class 2

Note: The chart shows end-to-end EVB efficiency. The voltage drop of the diode bridge is included. Indicator LEDs are removed as they are not part of the power conversion.

3.3. Thermal Measurements

The Si3406-ISO-FB EVB’s temperature was measured at maximum **input power – 6.5 W**. The Si3406-ISO-FB EVB is configured for 3.3 V output voltage and Class 2 power level. Figure 8 shows the thermal images taken of the EVB board at maximum input power.

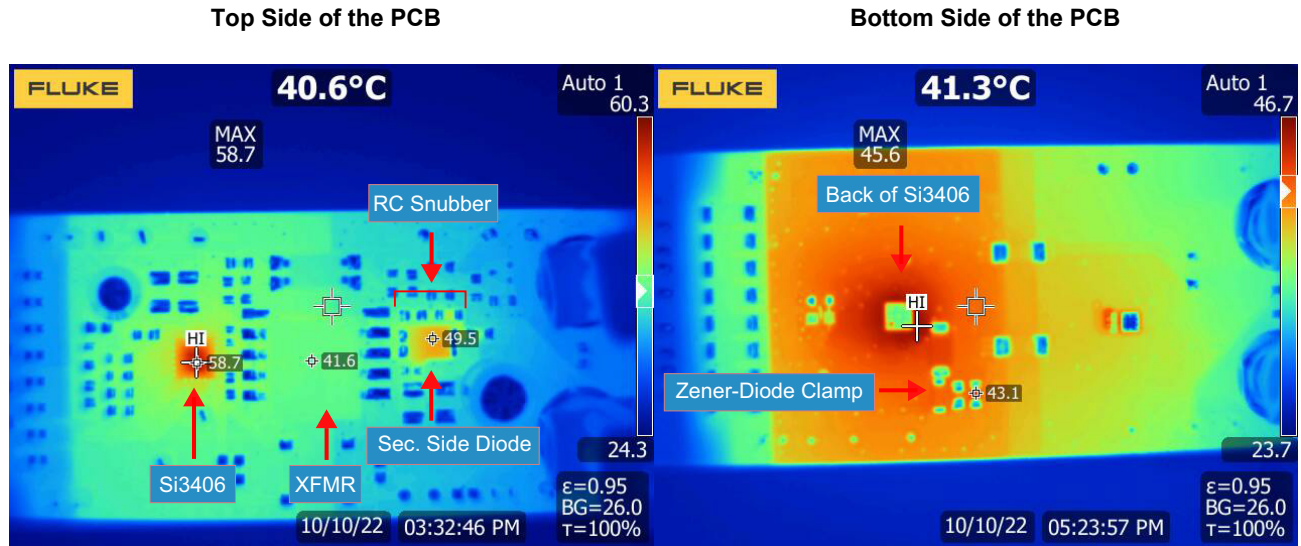

Figure 8. Thermal Measurements of the Si3406-ISO-FB Isolated EVB, 3.3 V, Class 2 PD

Table 2 lists the temperatures of the notable components across the board.

Table 2. Component Temperatures at Full Load

Component	Temperature ¹
Si3406 – U3	58.7 °C
Flyback Transformer – T1	41.6 °C
Secondary Side Diode – D1	49.5 °C
Primary Side Zener-Diode Clamp – D4-D5	43.1 °C
Note:	
1. The ambient temperature was 26 °C during the thermal measurements.	

3.4. SIFOS PoE Compatibility Test Results

The PDA-604A Powered Device Analyzer is a single-box comprehensive solution for testing IEEE 802.3at and IEEE 802.3bt PoE Powered Devices (PDs). The Si3406-ISO-FB 3.3 V EVB board has been successfully tested with the PDA-604A Powered Device Analyzer from Sifos Technologies.

See “9. Complete 3.3 V Si3406 Isolated Flyback Sifos Compatibility Test Reports” on page 68 for more information.

3.5. Adjustable EVB Current Limit

For additional safety, the Si3406 has an adjustable EVB current limit feature.

The Si3406 controller measures the voltage on the R_{SENSE} resistor (R5) through the ISNS pin. Care must be taken that this voltage goes below V_{SS} . When the voltage on the R5 is $V_{ISNS} = -270$ mV (referenced to V_{SS}), the internal current limit circuit restarts the PD to protect the application.

The EVB current limit for this Class 2 application can be calculated with the following formula:

$$R_{SENSE} = 1.2 \Omega$$
$$I_{LIMIT} = \frac{270 \text{ mV}}{1.2 \Omega} = 225 \text{ mA}$$

Equation 1. EVB Class 2 Current Limit

3.6. Feedback Loop Phase and Gain Measurement Results (Bode Plots)

The Si3406 device integrates a current-mode-controlled switching mode power supply controller circuit. Therefore, the application is a closed-loop system. To guarantee stable output voltage of the power supply and to reduce the influence of the input voltage variations and load changes on the output voltage, the feedback loop should be stable.

To verify the stability of the loop, the gain and phase of the loop has been measured.

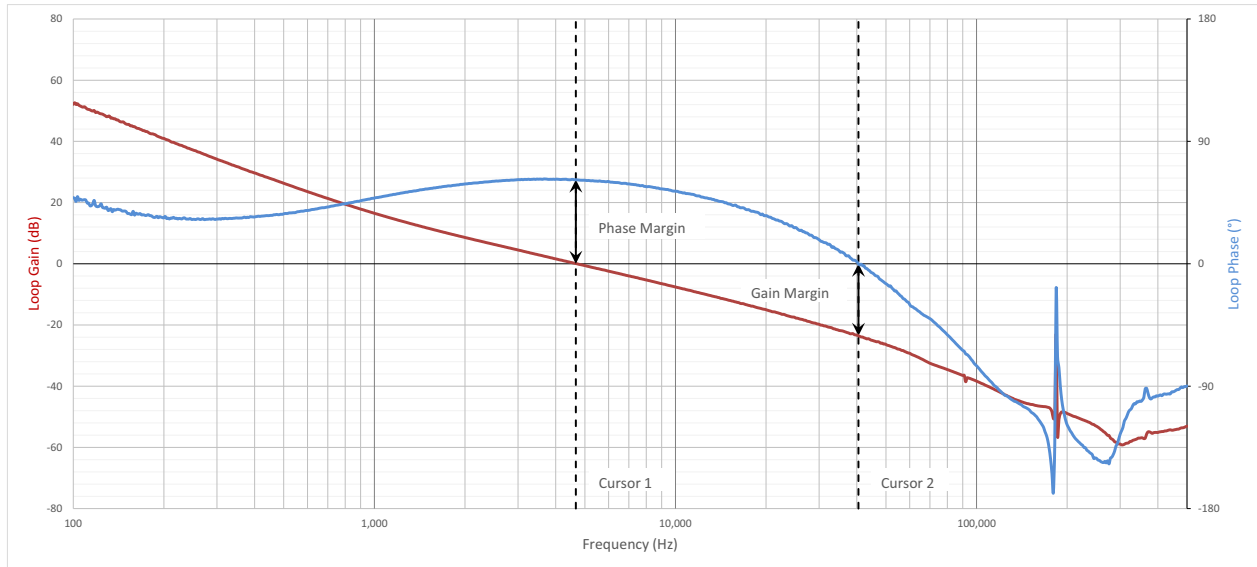

Figure 9. Si3406-ISO-FB Isolated EVB, 3.3 V, Class 2 PD Feedback Loop Measurement Results at Light Load

Table 3. Measured Loop Gain and Phase Margin at Light Load

	Frequency	Gain	Phase
Cursor 1 (Phase Margin)	4.67 kHz	0 dB	61.86°
Cursor 2 (Gain Margin)	40.53 kHz	23.52 dB	0°

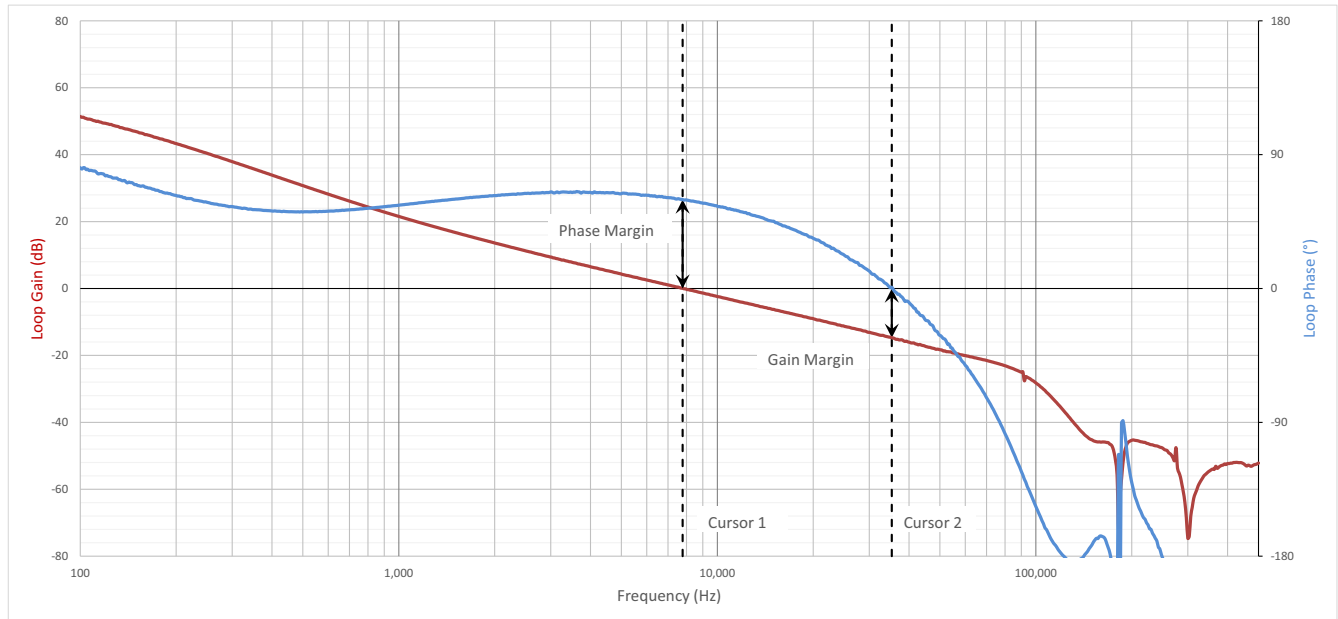

Figure 10. Si3406-ISO-FB Isolated EVB, 3.3 V, Class 2 PD Feedback Loop Measurement Results at Full Load

Table 4. Measured Loop Gain and Phase Margin at Full Load

	Frequency	Gain	Phase
Cursor 1 (Phase Margin)	7.78 kHz	0 dB	59.84 °
Cursor 2 (Gain Margin)	35.29 kHz	14.72 dB	0 °

Table 5 sums up the circumstances of the feedback loop measurements.

Table 5. Feedback Loop Measurement Circumstances

Measurement Name	Input Voltage	Output Load
Feedback Loop Measurement at Light Load	50 V	10 Ω
Feedback Loop Measurement at Full Load	50 V	2.22 Ω

3.7. Load Step Transient Measurement Results

The output of the Si3406-ISO-FB EVB board's output has been tested with a load step function to verify the converter's output dynamic response.

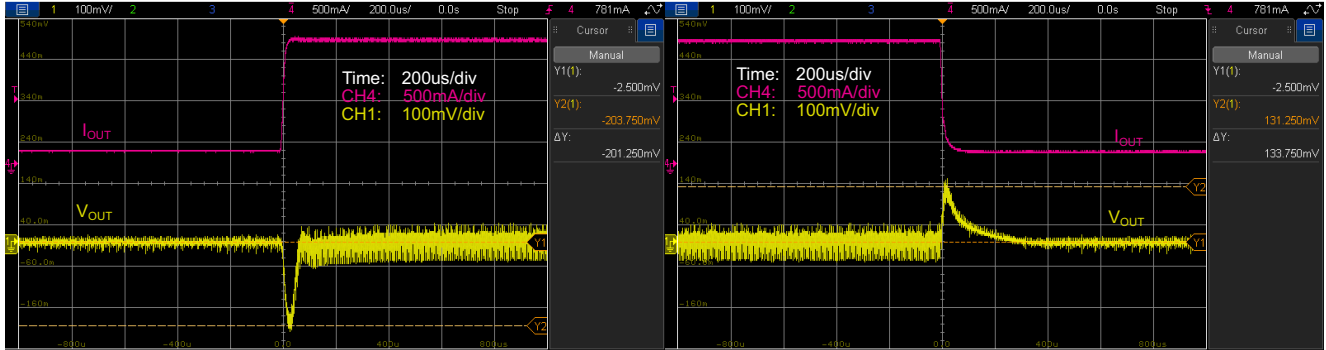

Figure 11. Si3406-ISO-FB EVB, 3.3 V, Class 2 PD Output Load Step Transient Test

Table 6 sums up the results of the load step measurements.

Table 6. Output Load Step Transient Results

Measurement Name	From (Output Current)	To (Output Current)	Slew Rate (Output Current)	V _{OUT} Change
Stepping up the load	0.15 A	1.5 A	2500 mA/μs	3.3 V – 201.25 mV
Stepping down the load	1.5 A	0.15 A	2500 mA/μs	3.3 V + 130.75 mV

3.8. Output Voltage Ripple

The Si3406-ISO-FB EVB output voltage ripple has been measured under both No-Load and Heavy-Load conditions.

No-Load V_{OUT} Ripple = 21.58 mV

Heavy-Load V_{OUT} Ripple = 77.5 mV

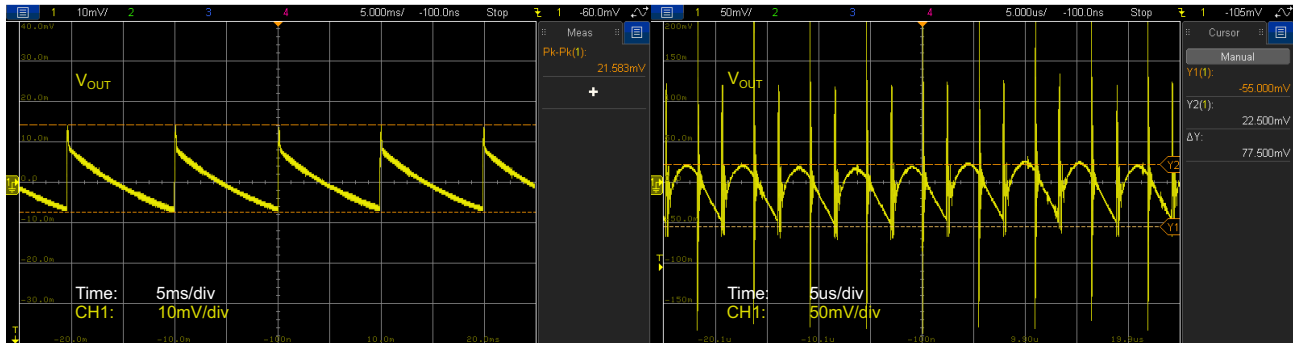

Figure 12. Si3406-ISO-FB EVB, 3.3 V, Class 2 Output Voltage Ripple No Load (Left) and Heavy Load (Right) Conditions

3.9. Soft-Start Protection

The Si3406 device has an integrated dynamic soft-start protection mechanism to avoid stressing the components by the sudden current or voltage changes associated with the initial charging of the output capacitors.

The Si3406 intelligent adaptive soft-start mechanism does not require any external component to be installed. The controller continuously measures the input current of the PD and dynamically adjusts the internal I_{PEAK} limit during soft-start, thus adjusting the output voltage ramp-up time as a function of the attached load.

The controller allows the output voltage to rise faster in no load (or light load) condition. With heavy load at the output, the controller slows down the output voltage ramp to avoid exceeding the desired regulated output voltage value.

No-Load Soft-Start t_{RISE} Ripple = 2.8 ms

Heavy-Load Soft-Start t_{RISE} Ripple = 15.0 ms

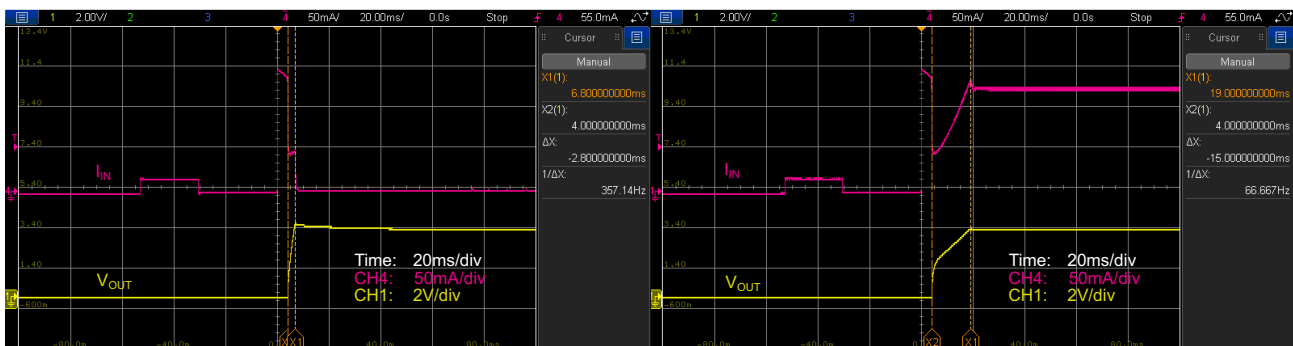

Figure 13. Si3406-ISO-FB EVB, 3.3 V, Class 2 Output Voltage Soft-Start at Low Load (Left) and Heavy Load (Right) Conditions

3.10. Output Short Protection

The Si3406 has an integrated output short protection mechanism, which protects the IC and surrounding external components from overheating in the case of an electrical short on the output.

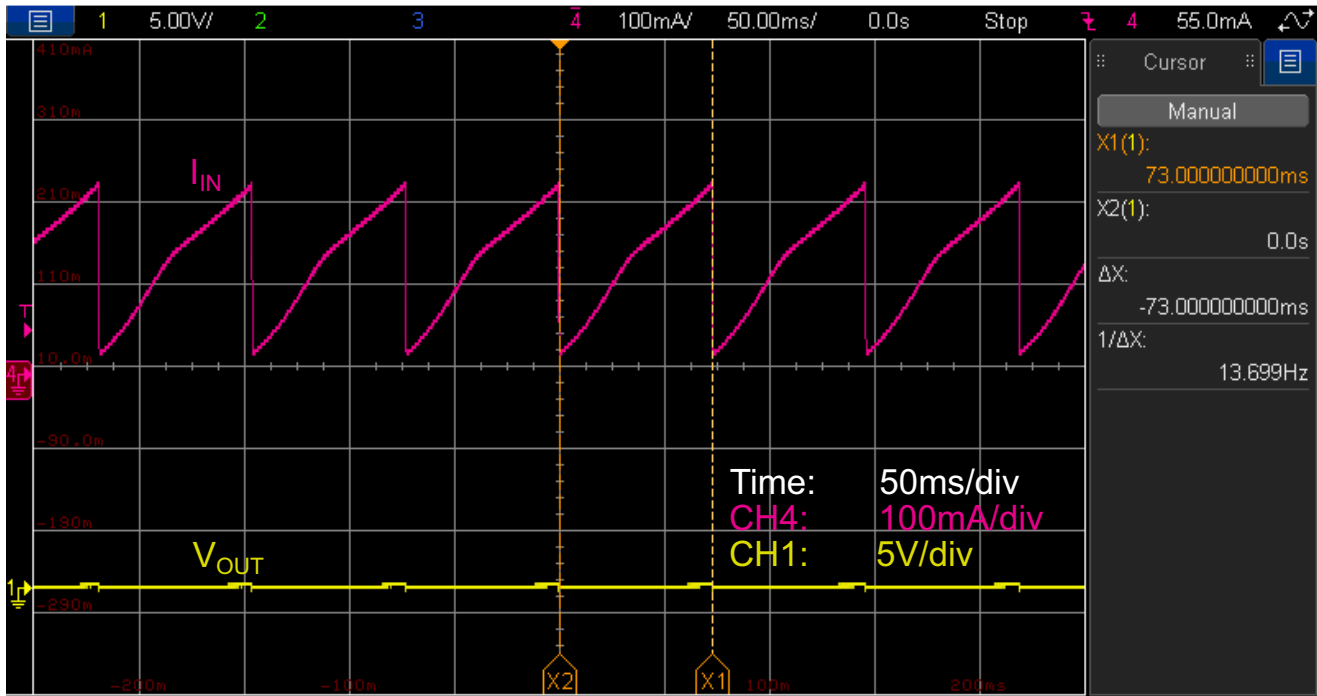

Figure 14. Si3406-ISO-FB EVB, 3.3 V, Class 2 Output Short Circuit Protection

3.11. Pulse Skipping at No-Load Condition

The Si3406 device has an integrated pulse skipping mechanism to ensure ultra-low power consumption at light load condition.

As the output load decreases, the controller starts to reduce the pulse-width of the PWM signal (switcher ON time). At some point, even the minimum width pulse would provide higher energy than the application requires, which could result in loss of voltage regulation.

When the controller detects light load condition (which requires less ON time than the minimum pulse width), the controller enters into pulse-skipping mode. This mode is shown in the following figure, which depicts the switching node of the integrated switching FET at a no load condition.

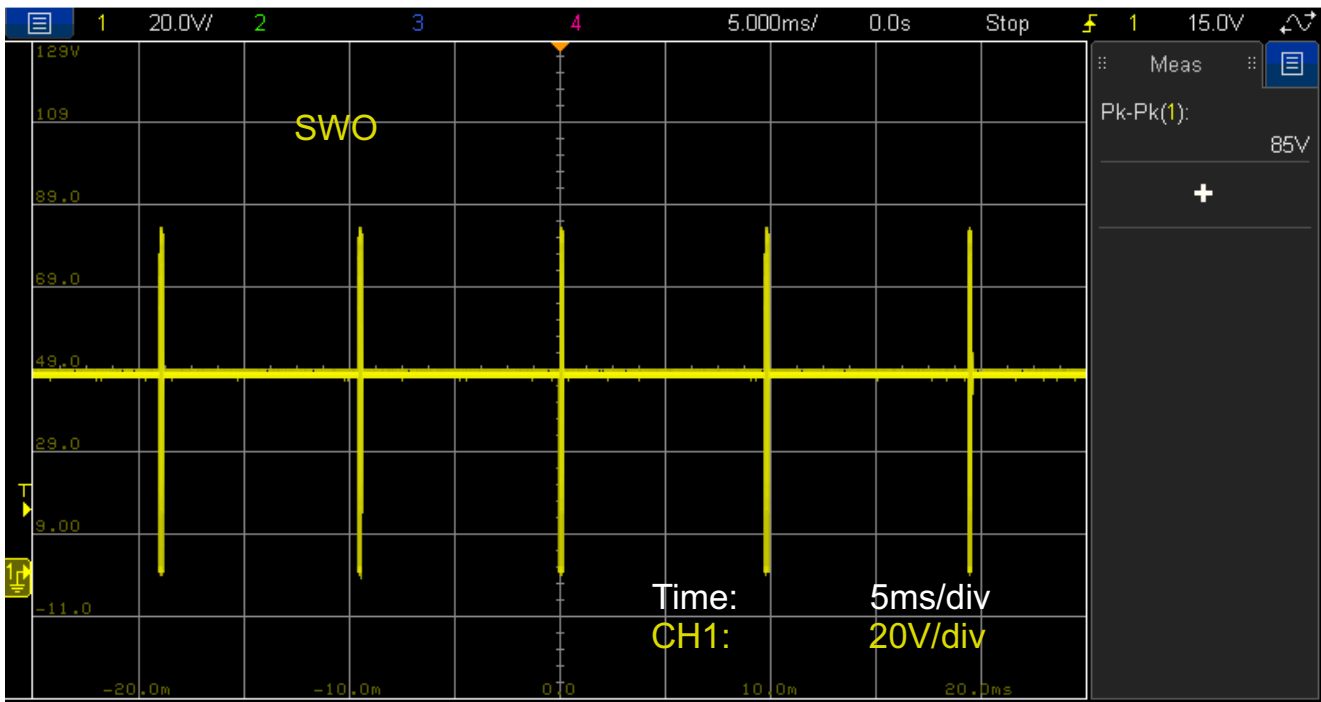

Figure 15. Si3406-ISO-FB EVB, 3.3 V, Class 2 Pulse Skipping at No-load Condition: SWO Waveform

3.12. Discontinuous (DCM) and Continuous (CCM) Conduction Modes

At low load, the converter works in discontinuous conduction mode (DCM). At heavy load, the converter runs in continuous conduction mode (CCM). At low load, the SWO voltage waveform has a ringing waveform, which is typical for DCM operation.

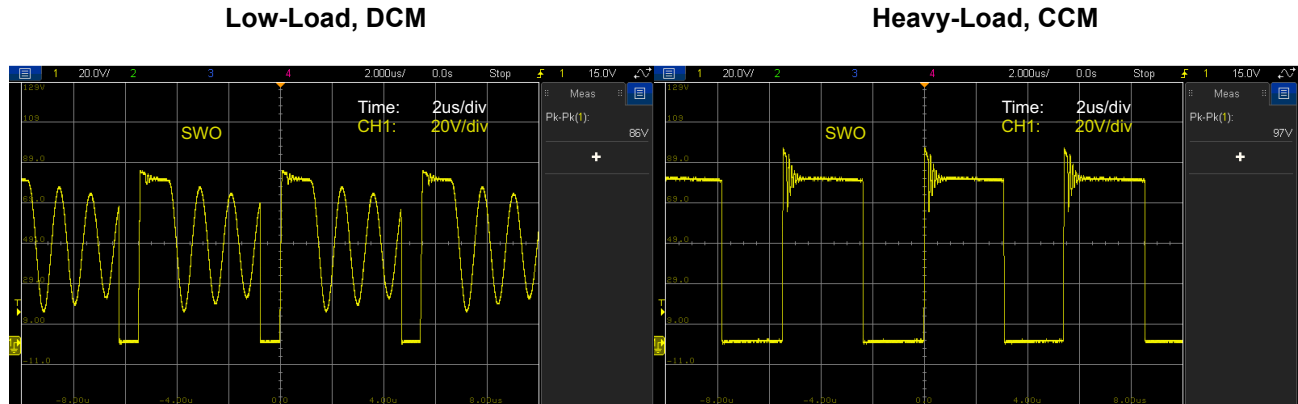

Figure 16. Si3406-ISO-FB EVB, 3.3 V, Class 2: SWO Waveform in Discontinuous Conduction Mode (DCM) at Low Load (Left), and in Continuous Conduction Mode (CCM) at Heavy Load (Right)

Similar voltage waveforms can be observed on the secondary side diode, D1. The voltage amplitudes on the secondary side diode, D1, are much lower due to the transformer turns ratio; however, the discontinuous and continuous conduction mode characteristics are still present.

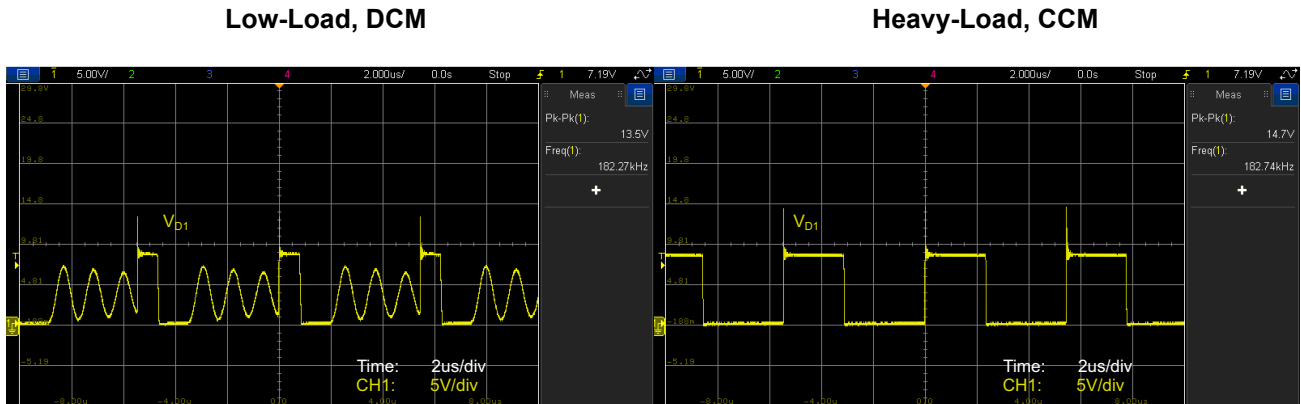

Figure 17. Si3406-ISO-FB EVB, 3.3 V, Class 2: Secondary Side Diode Voltage Waveform in Discontinuous Conduction Mode (DCM) at Low Load (Left), and in Continuous Conduction Mode (CCM) at Heavy Load (Right)

3.13. Maintain Power Signature (MPS)

The Si3406-ISO-FB EVB board has a built-in MPS feature which is enabled by default. The Si3406 maintains the connection with the PSE when the PD is in a low-current consumption mode. MPS can be used in user mode or in automatic mode. In user mode, nSLEEP shall be tied to VDD at startup (R13) and the host controller needs to manually start/stop MPS generation by pulling the nSLEEP line low or high respectively. To enable automatic MPS feature, nSLEEP shall be tied to VSS at startup (R15). In automatic mode, Si3406 monitors the input current and turns on MPS automatically when it falls below a predefined level.

Note Si3406 assumes a minimum consumption of the host controller. Therefore, to pass Sifos MPS tests, a dummy load has been installed on the EVB (R22) along with the pre-installed status LED to keep the consumption above the pre-defined current threshold. The figure below shows the automatic MPS pulses generated by the EVB with a 160 Ω dummy load installed at the output.

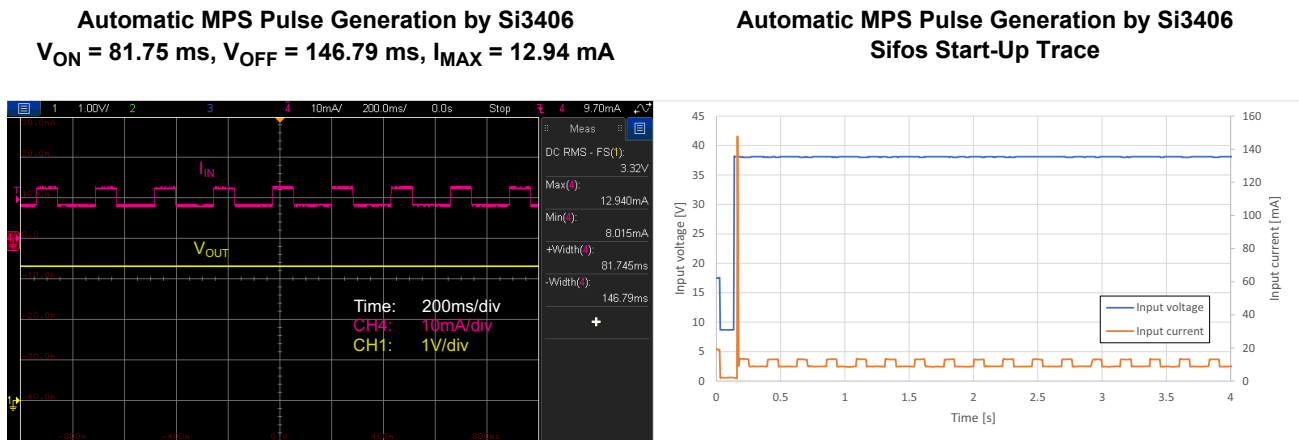

Figure 18. Si3406-ISO-FB EVB, 3.3 V, Class 2 PD Automatic Maintain Power Signature (MPS) Generation

3.14. (Optional) Secondary-Side Synchronous Rectification

The Si3406-ISO-FB EVB board has an option to include a Secondary-Side Synchronous Rectification which helps to increase overall efficiency. The necessary changes are indicated in the figure below.

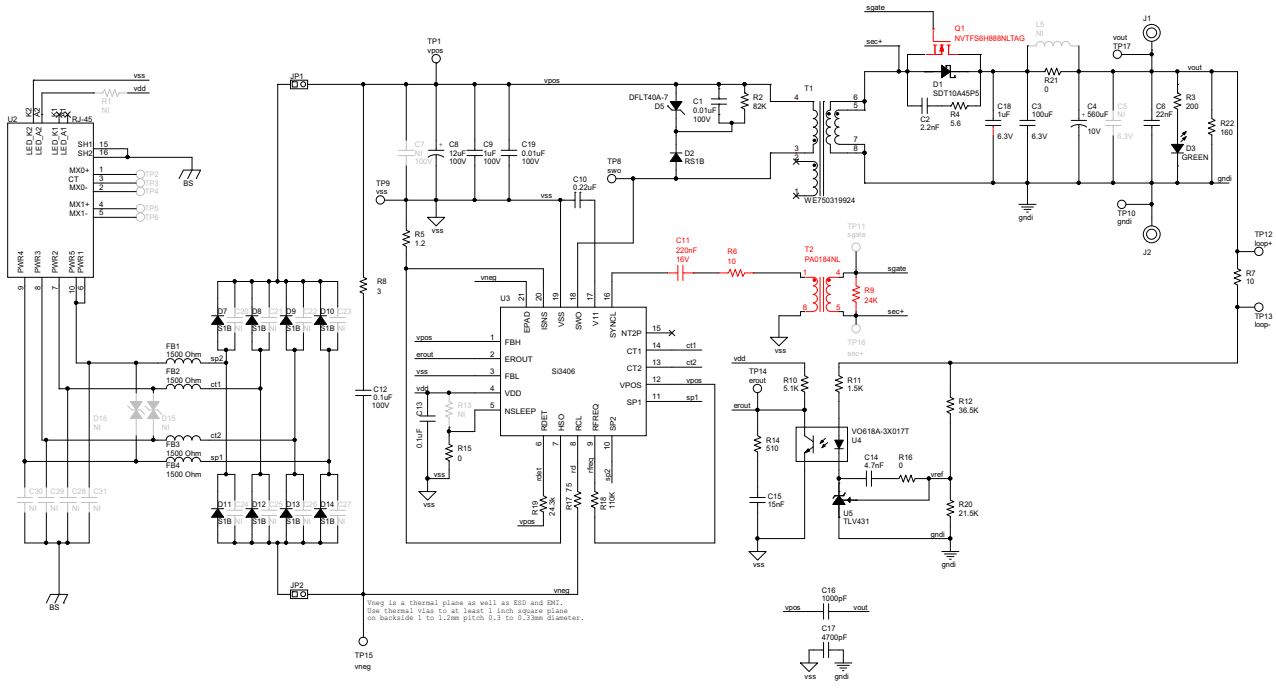

Figure 19. Si3406-ISO-FB EVB, 3.3 V, Class 2 Secondary-Side Synchronous Rectification Modifications

The following diagram shows the efficiency improvement of the EVB with the NVTFS6H888NLTAG MOSFET installed. The efficiency was measured at three different input voltage levels: 40.8 V, 50 V, and 57 V.

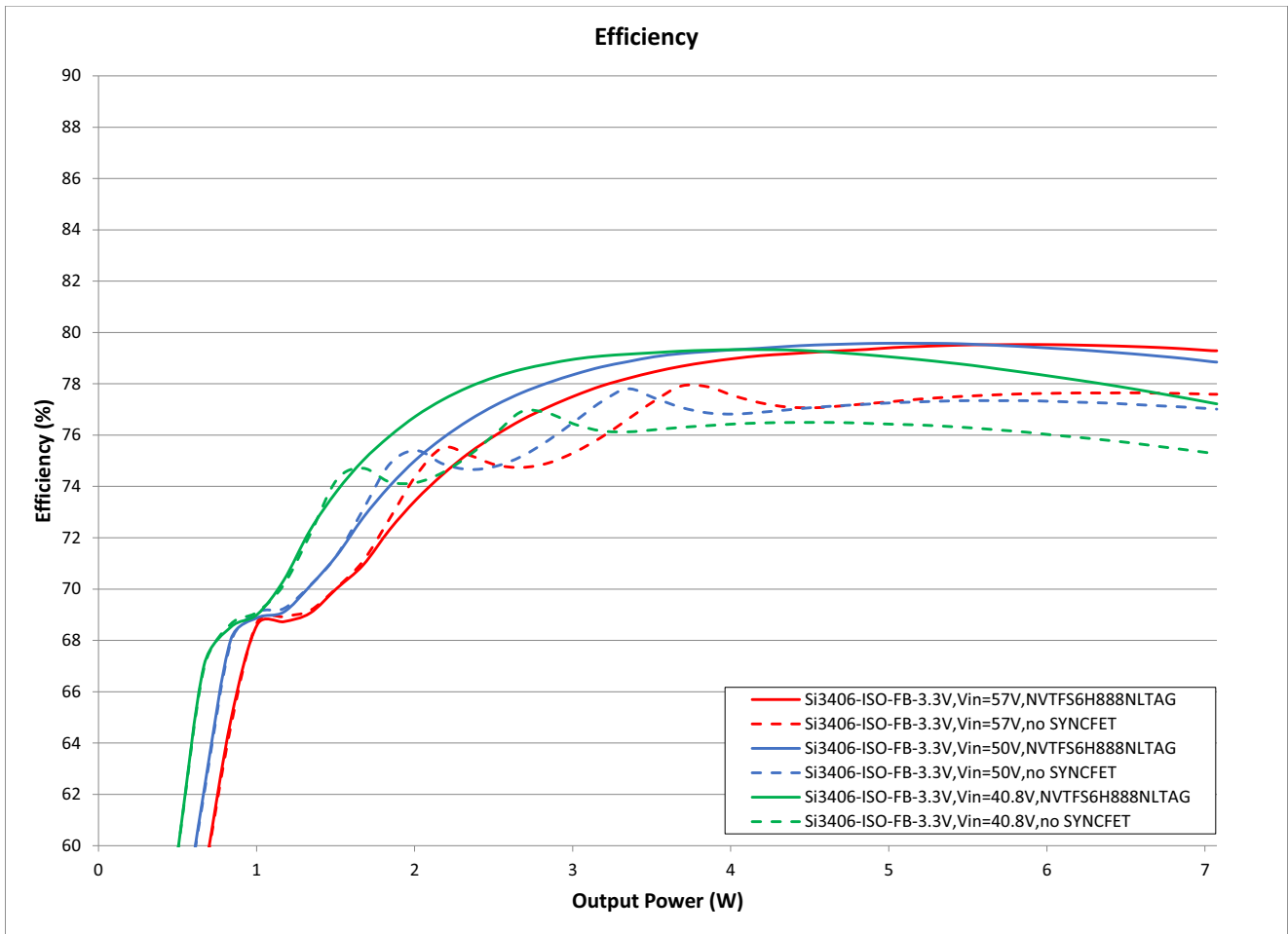

Figure 20. Si3406-ISO-FB End-to-End Efficiency Chart with Internal Input Bridge Diodes and Secondary-Side Synchronous Rectification: 40.8V, 50 V and 57V Input, 3.3 V Output, Class 2

3.15. Radiated Emissions Measurement Results

Radiated emissions of the Si3406-ISO-FB, 3.3 V, Class 2 EVB board have been measured with 50 V input voltage and a full load connected to the output. The input power was 6.5 W in this case.

As shown below, the Si3406-ISO-FB, 3.3 V, Class 2 EVB is fully compliant with the international EN 55032 Class B emissions standard.

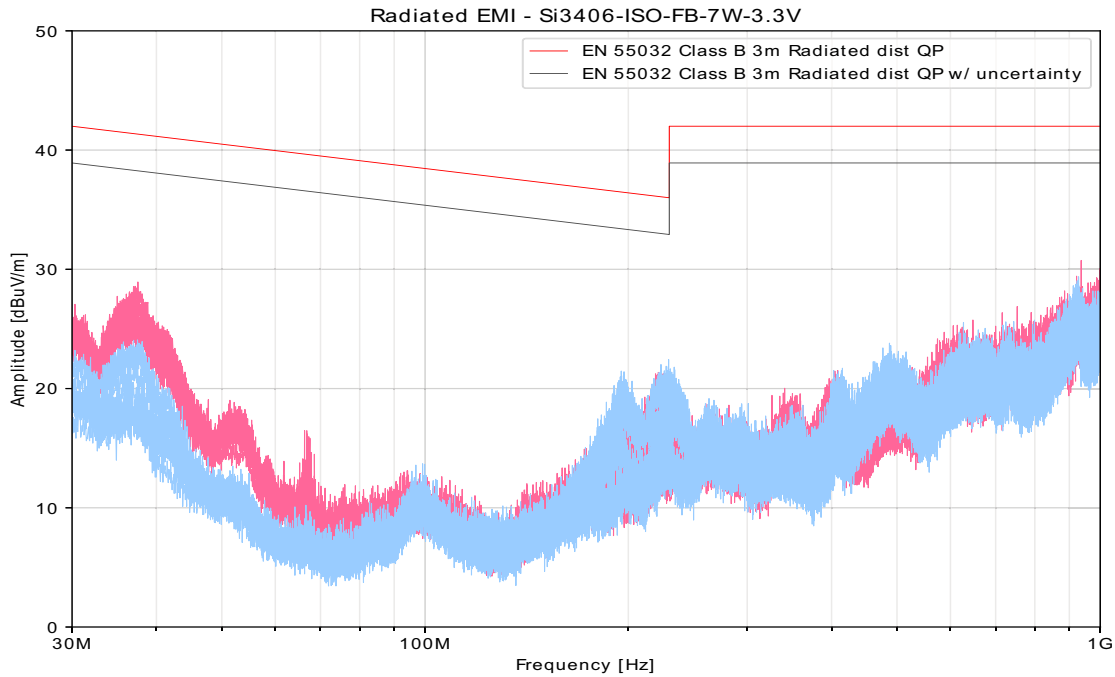

Figure 21. Si3406-ISO-FB EVB Radiated Emissions Measurements Results; 50 V Input, 3.3 V Output, 6.5 W Input Power

The EVB is measured at full load with peak detection in both vertical and horizontal polarizations. This is a relatively fast process that produces a red curve (vertical polarization) and a blue curve (horizontal polarization). The chamber was non-reflective and multiple measurements were made by rotating the table in 45 degree steps. All these measurement results are displayed on the graph above.

Next, specific frequencies are selected for quasi-peak measurements if the peak detection shows significant violations. The board is measured again at those specific frequencies with a quasi-peak detector, which is a very slow but accurate measurement. The results of this quasi-peak detector measurement are the blue rhombuses (if any). These frequencies and the corresponding results are displayed in the table above if quasi-peak measurements are executed.

The red and blue curves and the blue rhombuses (if any) represent the final result of the measurement process. To have passing results, the blue rhombuses should be below the highlighted EN 55032 Class B limit.

3.16. Conducted Emissions Measurement Results

The Si3406-ISO-FB, 3.3 V, Class 2 EVB board's conducted emissions have been measured in two different measurement methods to comply with the international EN 55032 standard. The EVB is supplied and measured on its PoE input port as shown in the following figure.

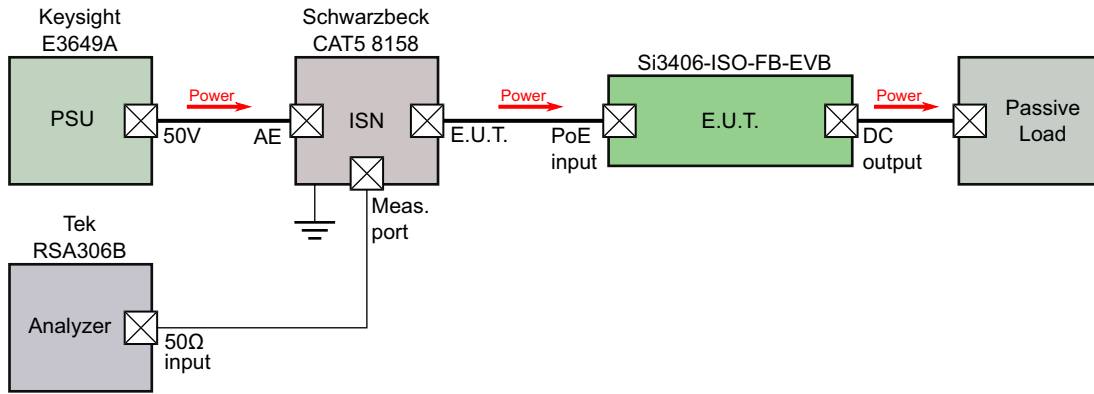

Figure 22. Conducted EMI Measurement Setup

The detector in the spectrum analyzer is set to:

- Peak detector and
- Average detector

Both results are shown in the following figure.

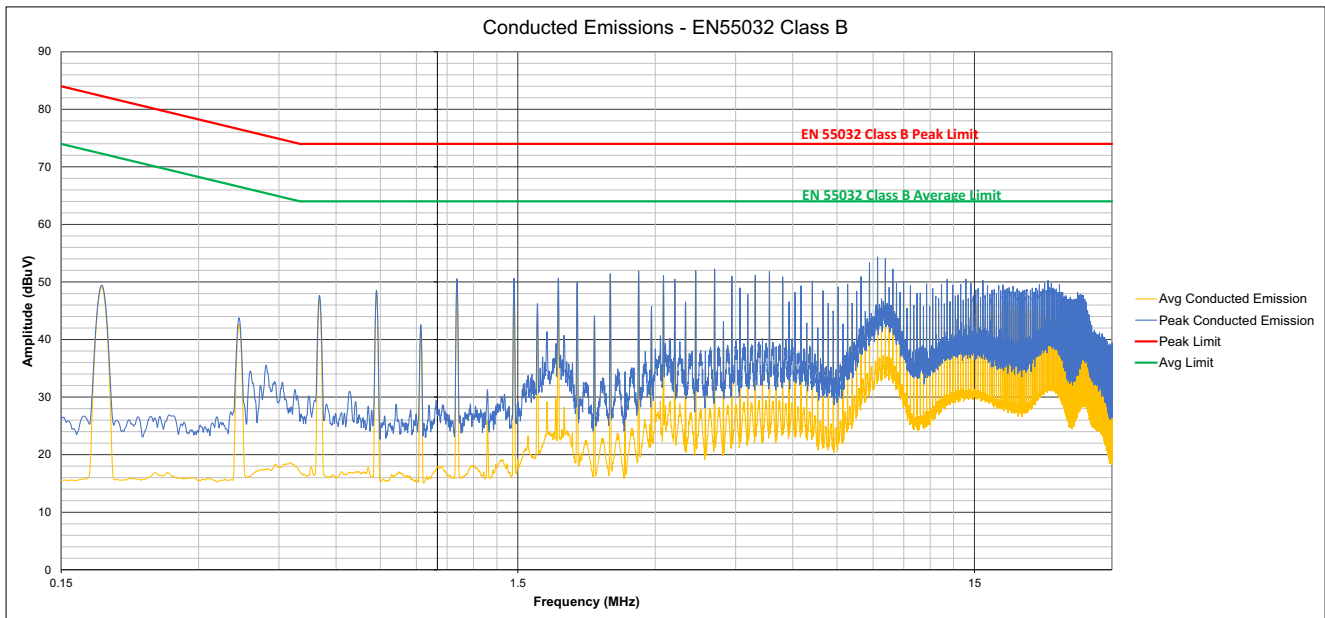

Figure 23. Si3406-ISO-FB EVB Conducted Emissions Measurements Results; 50 V Input, 3.3 V Output, 6.5 W Input Power

3.17. Bill of Materials

The following table is the BOM listing for the standard 3.3 V output evaluation board with option PoE Class 2.

Table 7. Si3406 Isolated Flyback 3.3 V Bill of Materials

Qty	Ref	Value	Rating	Voltage	Tol	Type	PCB_Footprint	Mfr Part Number	Manufacturer
1	C1	0.01uF		100V	±10%	X7R	C0805	C0805X7R101-103K	Venkel
1	C10	0.22uF		16V	±10%	X7R	C0805	C0805X7R160-224KNE	Venkel
1	C12	0.1uF		100V	±10%	X7R	C0805	C0805X7R101-104K	Venkel
1	C13	0.1uF		16V	±10%	X7R	C0805	C0805X7R160-104K	Venkel
1	C14	4.7nF		25V	±2%	C0G	C0805	C0805C0G250-472G	Venkel
1	C15	15nF		50V	±5%	C0G	C0805	C0805C0G500-153J	Venkel
1	C16	1000pF		2000V	±5%	C0G	C1808	C1808C0G202-102JNE	Venkel
1	C17	4700pF		2000V	±10%	X7R	C1808	C1808X7R202-472KNE	Venkel
1	C18	1uF		6.3V	±10%	X5R	C0603	C0603X5R6R3-105K	Venkel
1	C19	0.01uF		100V	±10%	X7R	C0603	C0603X7R101-103K	Venkel
1	C2	2.2nF		50V	±10%	C0G	C0805	C0805C0G500-222K	Venkel
1	C3	100uF		6.3V	±10%	X5R	C1210	C1210X5R6R3-107K	Venkel
1	C4	560uF		10V	±20%	Alum_Elec	C3.5X8MM-RAD	860020274012	Wurth Elektronik
1	C6	22nF		25V	±5%	C0G	C0805	C0805C0G250-223J	Venkel
1	C8	12uF		100V	±20%	Alum_Elec	C2.5X6.3MM-RAD	EEUFC2A120	Panasonic
1	C9	1uF		100V	±10%	X7R	C1210	C1210X7R101-105K	Venkel
1	D1	SDT10A45P5	10A	45V		Schottky	POWERDI-5	SDT10A45P5-7	Diodes Inc.
1	D2	RS1B	1.0A	100V		Single	DO-214AC	RS1B	Fairchild
1	D3	GREEN					LED-0805-K-K1A2	XZVG54W-8	SunLED
1	D5	DFLT40A-7	3.49A	40V		Zener	POWERDI-123	DFLT40A-7	Diodes Inc.
8	D7, D8, D9, D10, D11, D12, D13, D14	S1B	1.0A	100V		Single	DO-214AC	S1B	Fairchild
4	FB1, FB2, FB3, FB4	1500 Ohm	1000mA			SMT	L0805	742792097	Würth
2	J1, J2	BND_POST	15A			BANANA	BANANA-JACK	101	ABBATRON HH SMITH
2	JP1, JP2	HEADER 1X2				Header	CONN1X2	TSW-102-07-T-S	Samtec
1	LB1	LABEL-Si3406-EVB-ISO-FB-R4.2-3.3V				POLYIMIDE, WHITE	PTL-14-717	LABEL-Si3406-EVB-ISO-FB-R4.2-3.3V	Skyworks
4	MH1, MH2, MH3, MH4	4-40				SCREW	MH-125 MH-125NP	NSS-4-4-01	Richco Plastic Co
1	PCB1	Si3406-EVB-ISO-FB REV 4.0				BARE PCB	N/A	Si3406-EVB-ISO-FB REV 4.0	Skyworks

Table 7. Si3406 Isolated Flyback 3.3 V Bill of Materials (Continued)

Qty	Ref	Value	Rating	Voltage	Tol	Type	PCB_Footprint	Mfr Part Number	Manufacturer
1	R10	5.1 kΩ	1/10 W		±1%	ThickFilm	R0805	CR0805-10W-5101F	Venkel
1	R11	1.5 kΩ	1/8 W		±1%	ThickFilm	R0805	CR0805-8W-1501F	Venkel
1	R12	36.5 kΩ	1/10 W		±1%	ThickFilm	R0805	CR0805-10W-3652F	Venkel
1	R14	510 Ω	1/10 W		±1%	ThickFilm	R0805	CR0805-10W-5100F	Venkel
3	R15, R16, R21	0 Ω	2 A			ThickFilm	R0805	CR0805-10W-000	Venkel
1	R17	75 Ω	1/10 W		±1%	ThickFilm	R0805	CR0805-10W-75R0F	Venkel
1	R18	110 kΩ	1/10 W		±1%	ThickFilm	R0805	CR0805-10W-1103F	Venkel
1	R19	24.3 kΩ	1/8 W		±1%	ThickFilm	R0805	CRCW080524K3FKEA	vishay
1	R2	82 kΩ	1/10 W		±5%	ThickFilm	R0805	CR0805-10W-823J	Venkel
1	R20	21.5 kΩ	1/10 W		±1%	ThickFilm	R0805	CR0805-10W-2152F	Venkel
1	R22	160 Ω	1/4 W		±1%	ThickFilm	R1206	CR1206-4W-1600F	Venkel
1	R3	200 Ω	1/8 W		±1%	ThickFilm	R0805	CR0805-8W-2000F	Venkel
1	R4	5.6 Ω	1/10 W		±5%	ThickFilm	R0805	CR0805-10W-5R6J	Venkel
1	R5	1.2 Ω	1/10 W		±5%	ThickFilm	R0805	CR0805-10W-1R2J	Venkel
1	R7	10 Ω	1/10 W		±1%	ThickFilm	R0805	CR0805-10W-10R0F	Venkel
1	R8	3 Ω	1/8 W		±1%	ThickFilm	R0805	CR0805-8W-3R00FT	Venkel
4	SO1, SO2, SO3, SO4	STANDOFF				STANDOFF		2397	SPC Technology
1	T1	750319924		3.3 V		FLYBACK	XFMR-EP10	750319924	Würth Elektronik
3	TP1, TP12, TP17	RED				LOOP	TESTPOINT	5000	Keystone
6	TP8, TP9, TP10, TP13, TP14, TP15	BLACK				LOOP	TESTPOINT	5001	Keystone
1	U2	RJ-45				Receptacle	RJ45-74982104400	74982104400	Würth Elektronik
1	U3	Si3406		120 V		PD	QFN20N5X5P0.8	Si3406-A-GM	Skyworks
1	U4	VO618A-3X017T					SO4N10.16P2.54-AKEC	VO618A-3X017T	Vishay
1	U5	TLV431				SHUNT	TLV431-DBZ	TLV431BCDBZR	TI
Not Installed Components									
1	C11	0.22uF		16 V	±10%	X7R	C0805	C0805X7R160-224KNE	Venkel
8	C20, C21, C22, C23, C24, C25, C26, C27	1nF		100 V	±10%	X7R	C0603	C0603X7R101-102K	Venkel
4	C28, C29, C30, C31	1nF		2000 V	±5%	X7R	C1206	C1206C102JGRACU	Kemet
1	C5	100uF		6.3 V	±10%	X5R	C1210	C1210X5R6R3-107K	Venkel
1	C7	1uF		100 V	±10%	X7R	C1210	C1210X7R101-105K	Venkel
2	D15, D16	SMAJ58CA	400W	58 V		TVS	DO-214AC	SMAJ58CA	Littlefuse

Table 7. Si3406 Isolated Flyback 3.3 V Bill of Materials (Continued)

Qty	Ref	Value	Rating	Voltage	Tol	Type	PCB_Footprint	Mfr Part Number	Manufacturer
1	L5	1uH	2.4A		±20%	Shielded	L0805	TFM201208ALD-1R0MTCA	TDK
1	Q1	NVTFS6H888NLTAG	14A	80 V		N-CHNL	POWER33	NVTFS6H888NLTAG	ON Semiconductor
1	R1	1K	1/10W		±1%	ThickFilm	R0805	CR0805-10W-1001F	Venkel
1	R13	0	2A			ThickFilm	R0805	CR0805-10W-000	Venkel
1	R6	10	1/10W		±1%	ThickFilm	R0805	CR0805-10W-10R0F	Venkel
1	R9	24K	1/10W		±1%	ThickFilm	R0805	CR0805-10W-2402FT	Venkel
1	T2	1200uH	none	1500 V	none		XFMR-PA0184NL	PA0184NL	Pulse Engineering
7	TP2, TP3, TP4, TP5, TP6, TP11, TP16	BLACK				LOOP	TESTPOINT	5001	Keystone

4. Si3406-ISO-FB EVB: 5 V, Class 2 Configuration

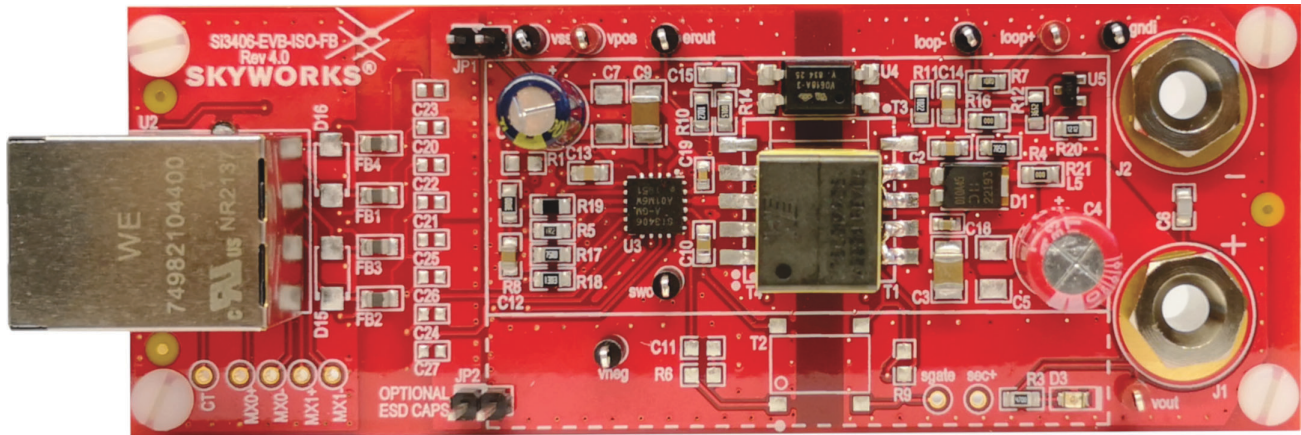

Figure 24. Si3406-ISO-FB EVB 5 V Board

4.1. Si3406-ISO-FB EVB Schematic: 5 V, Class 2, 7W

The figure below shows the schematic of the Si3406-ISO-FB 5 V, Class 2 EVB. The parts in red on the schematic represent the BOM differences compared to the other output voltage variants of this EVB. The parts in gray are not installed on the EVB, but they have footprints.

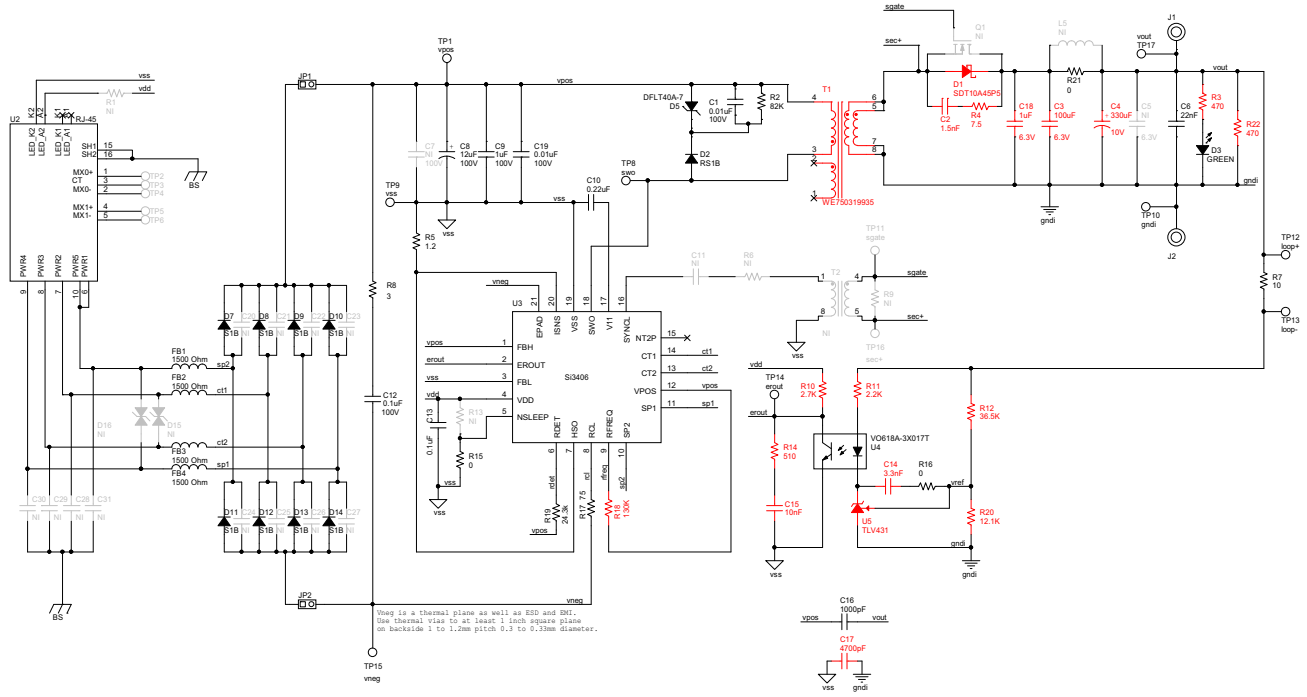

Figure 25. Si3406-ISO-FB Isolated EVB Schematic: 5 V, Class 2 PD, 7W

4.2. End-to-End EVB Efficiency

The end-to-end conversion efficiency measurement data of the Si3406 5 V ISO-FB board is shown below with internal and external (S1B) input bridges. Efficiency was measured from PoE (RJ45 connector) input to the 5 V output. The efficiency was measured at three different input voltage levels: 40.8 V, 50 V, and 57 V.

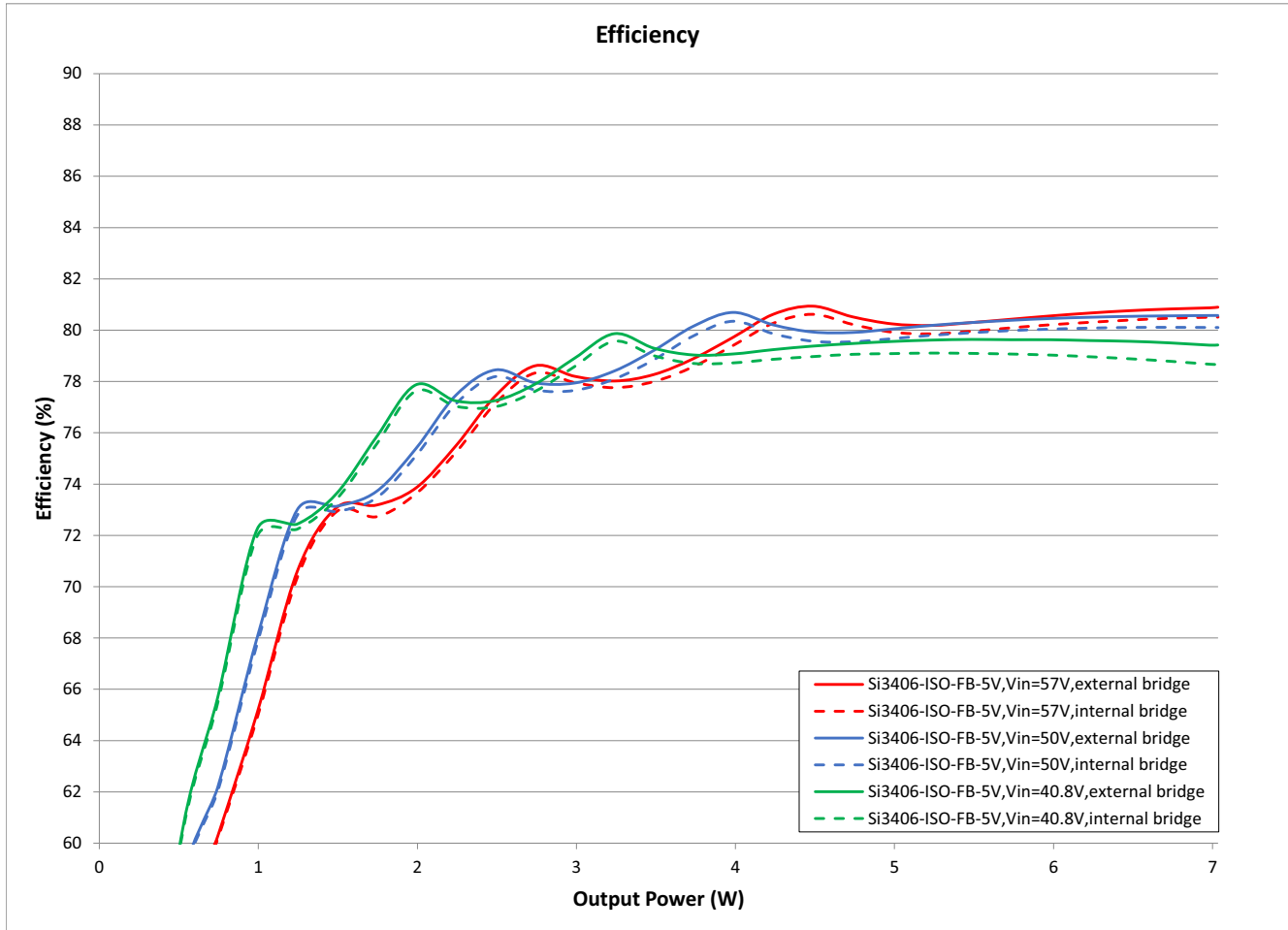

Figure 26. Si3406-ISO-FB End-to-End Efficiency Chart with Internal and External (S1B) Input Bridge Diodes: 40.8 V, 50 V and 57 V Input, 5 V Output, Class 2

Note The chart shows end-to-end EVB efficiency. The voltage drop of the diode bridge is included. Indicator LEDs are removed as they are not part of the power conversion.

4.3. Thermal Measurements

The Si3406-ISO-FB EVB’s temperature was measured at maximum **input power – 6.5 W**. The Si3406-ISO-FB EVB is configured for 5 V output voltage and Class 2 power level. Figure 27 shows the thermal images taken of the EVB board at maximum input power.

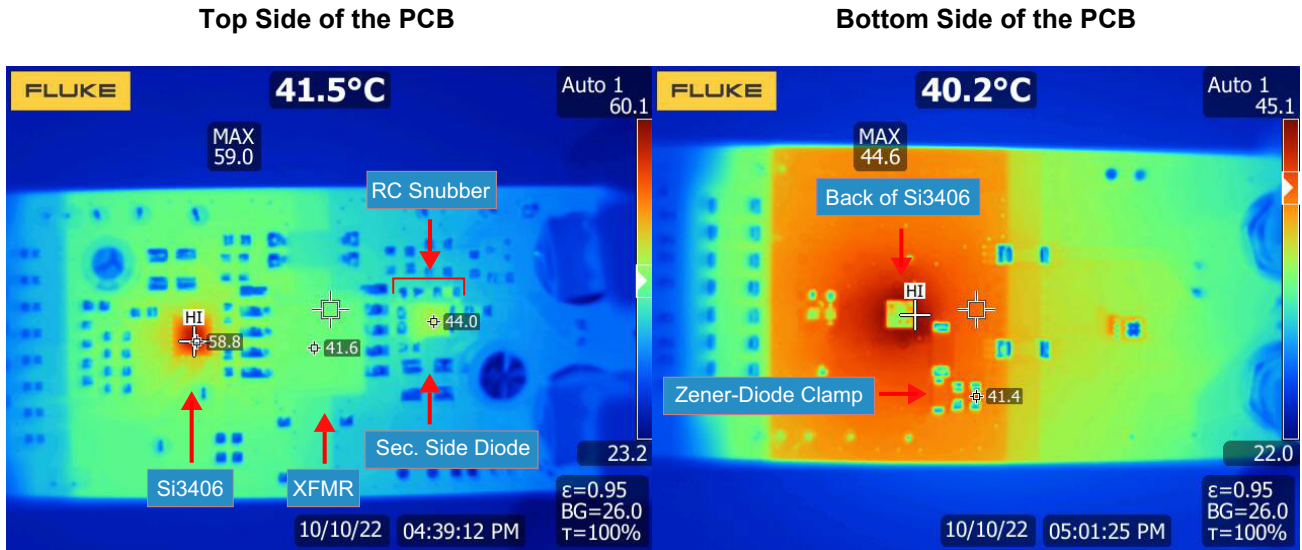

Figure 27. Thermal Measurements of the Si3406-ISO-FB Isolated EVB, 5 V, Class 2 PD

Table 8 lists the temperatures of notable components across the board.

Table 8. Component Temperatures at Full Load

Component	Temperature ¹
Si3406 – U3	58.8 °C
Flyback Transformer – T1	41.6 °C
Secondary Side Diode – D1	44.0 °C
Primary Side Zener-Diode Clamp – D4-D5	41.4 °C
Note	
1. The ambient temperature was 26 °C during the thermal measurements.	

4.4. SIFOS PoE Compatibility Test Results

The PDA-604A Powered Device Analyzer is a single-box comprehensive solution for testing IEEE 802.3at and IEEE 802.3bt PoE Powered Devices (PDs). The Si3406-ISO-FB 5 V EVB board has been successfully tested with the PDA-604A Powered Device Analyzer from Sifos Technologies.

See “10. Complete 5 V Si3406 Isolated Flyback Sifos Compatibility Test Reports” on page 76 for more information.

4.5. Adjustable EVB Current Limit

For additional safety, the Si3406 has an adjustable EVB current limit feature.

The Si3406 controller measures the voltage on the RSENSE resistor (R5) through the ISNS pin. Care must be taken that this voltage goes below VSS. When the voltage on the R5 is $V_{ISNS} = -270$ mV (referenced to VSS), the internal current limit circuit restarts the PD to protect the application.

The EVB current limit for this Class 2 application can be calculated with the following formula:

$$R_{SENSE} = 1.2 \Omega$$
$$I_{LIMIT} = \frac{270 \text{ mV}}{1.2 \Omega} = 225 \text{ mA}$$

Equation 2. EVB Class 2 Current Limit

4.6. Feedback Loop Phase and Gain Measurement Results (Bode Plots)

The Si3406 device integrates a current-mode-controlled switching mode power supply controller circuit. Therefore, the application is a closed-loop system. To guarantee stable output voltage of the power supply and to reduce the influence of the input voltage variations and load changes on the output voltage, the feedback loop should be stable.

To verify the stability of the loop, the gain and phase of the loop has been measured.

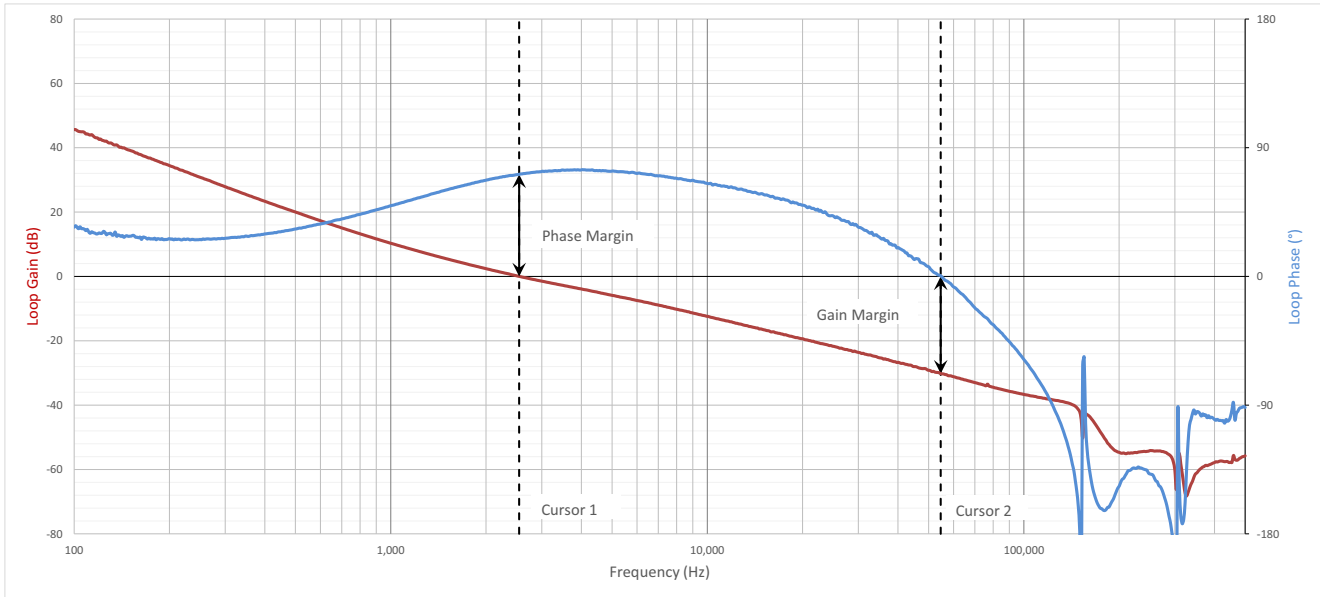

Figure 28. Si3406-ISO-FB Isolated EVB, 5 V, Class 2 PD Feedback Loop Measurement Results at Light Load

Table 9. Measured Loop Gain and Phase Margin at Light Load

	Frequency	Gain	Phase
Cursor 1 (Phase Margin)	2.54 kHz	0 dB	71.39°
Cursor 2 (Gain Margin)	54.61 kHz	30.22 dB	0°

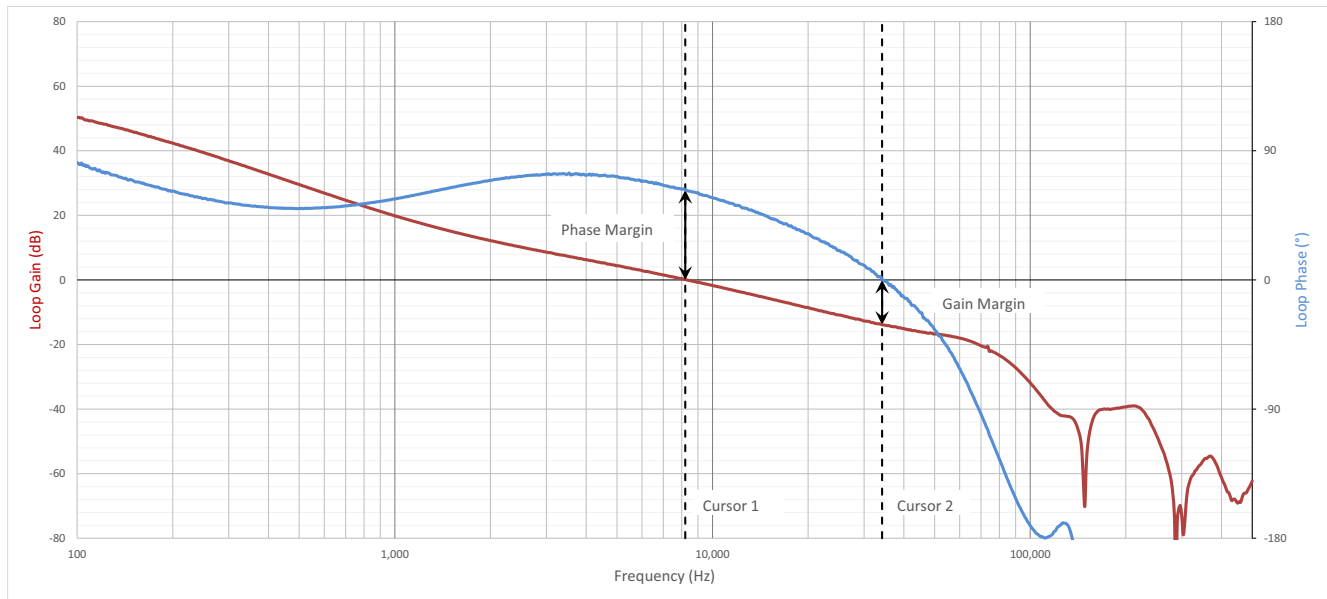

Figure 29. Si3406-ISO-FB Isolated EVB, 5 V, Class 2 PD Feedback Loop Measurement Results at Full Load

Table 10. Measured Loop Gain and Phase Margin at Full Load

	Frequency	Gain	Phase
Cursor 1 (Phase Margin)	8.21 kHz	0 dB	62.7°
Cursor 2 (Gain Margin)	34.18 kHz	13.9 dB	0°

Table 11 sums up the circumstances of the feedback loop measurements.

Table 11. Feedback Loop Measurement Circumstances

Measurement Name	Input Voltage	Output Load
Feedback Loop Measurement at Light Load	50 V	20 Ω
Feedback Loop Measurement at Full Load	50 V	4.49 Ω

4.7. Load Step Transient Measurement Results

The output of the Si3406-ISO-FB EVB board's output has been tested with a load step function to verify the converter's output dynamic response.

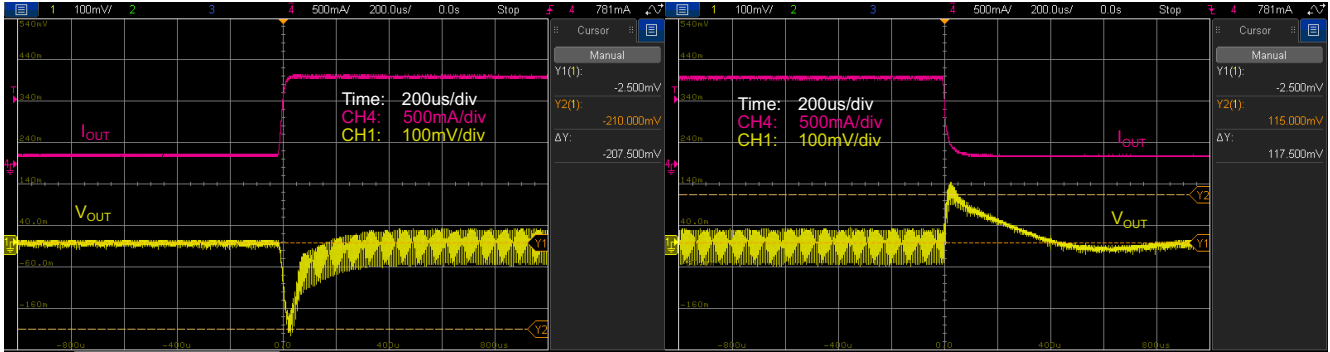

Figure 30. Si3406-ISO-FB EVB, 5 V, Class 2 PD Output Load Step Transient Test

The following table sums up the results of the load step measurements.

Table 12. Output Load Step Transient Results

Measurement Name	From (Output Current)	To (Output Current)	Slew Rate (Output Current)	VOUT Change
Stepping up the load	0.1 A	1.05 A	2500 mA/μs	5 V – 207.5 mV
Stepping down the load	1.05 A	0.1 A	2500 mA/μs	5 V + 117.5 mV

4.8. Output Voltage Ripple

The Si3406-ISO-FB EVB output voltage ripple has been measured under both No-Load and Heavy-Load conditions.

No-Load V_{OUT} Ripple = 29.9 mV

Heavy-Load V_{OUT} Ripple = 90.63 mV

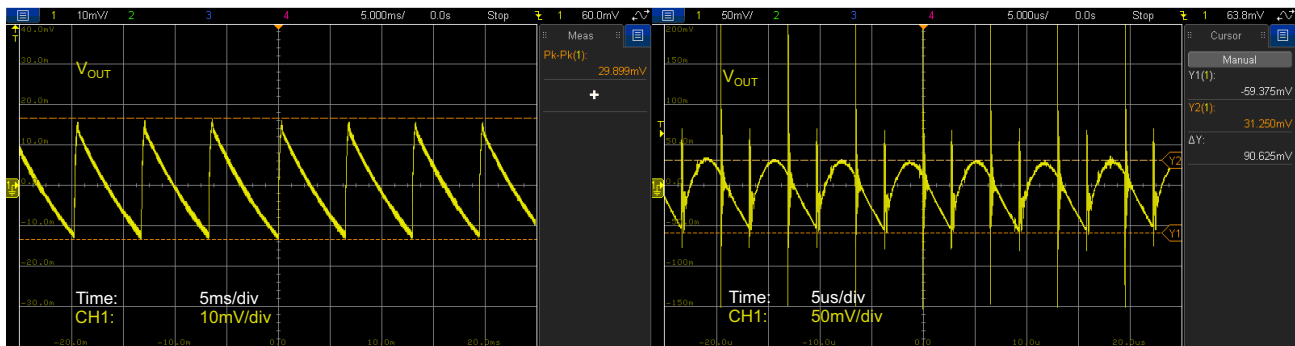

Figure 31. Si3406-ISO-FB EVB, 5 V, Class 2 Output Voltage Ripple No Load (Left) and Heavy Load (Right) Conditions

4.9. Soft-Start Protection

The Si3406 device has an integrated dynamic soft-start protection mechanism to avoid stressing the components by the sudden current or voltage changes associated with the initial charging of the output capacitors.

The Si3406 intelligent adaptive soft-start mechanism does not require any external component to be installed. The controller continuously measures the input current of the PD and dynamically adjusts the internal I_{PEAK} limit during soft-start, thus adjusting the output voltage ramp-up time as a function of the attached load.

The controller allows the output voltage to rise faster in no load (or light load) condition. With heavy load at the output, the controller slows down the output voltage ramp to avoid exceeding the desired regulated output voltage value.

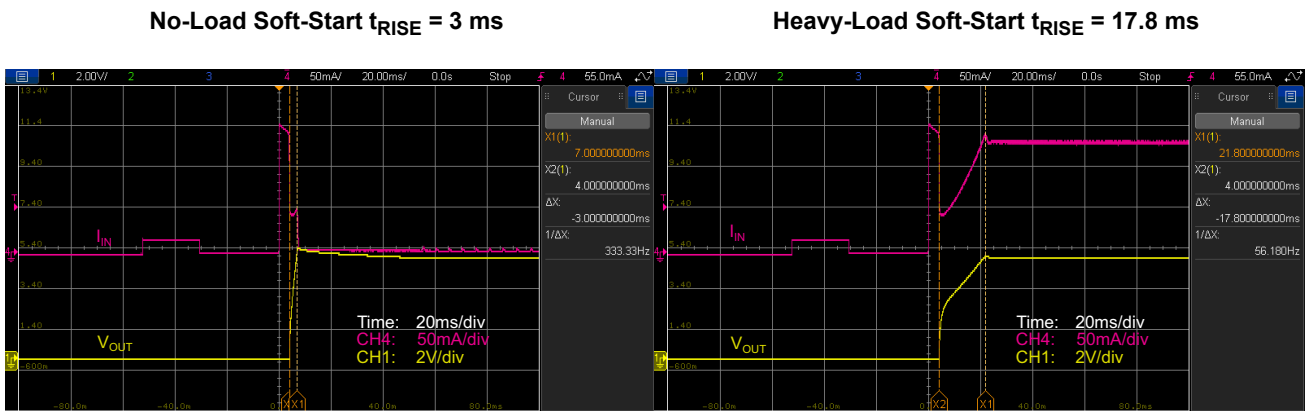

Figure 32. Si3406-ISO-FB EVB, 5 V, Class 2 Output Voltage Soft-Start at Low Load (Left) and Heavy Load (Right) Conditions

4.10. Output Short Protection

The Si3406 has an integrated output short protection mechanism, which protects the IC and surrounding external components from overheating in the case of an electrical short on the output.

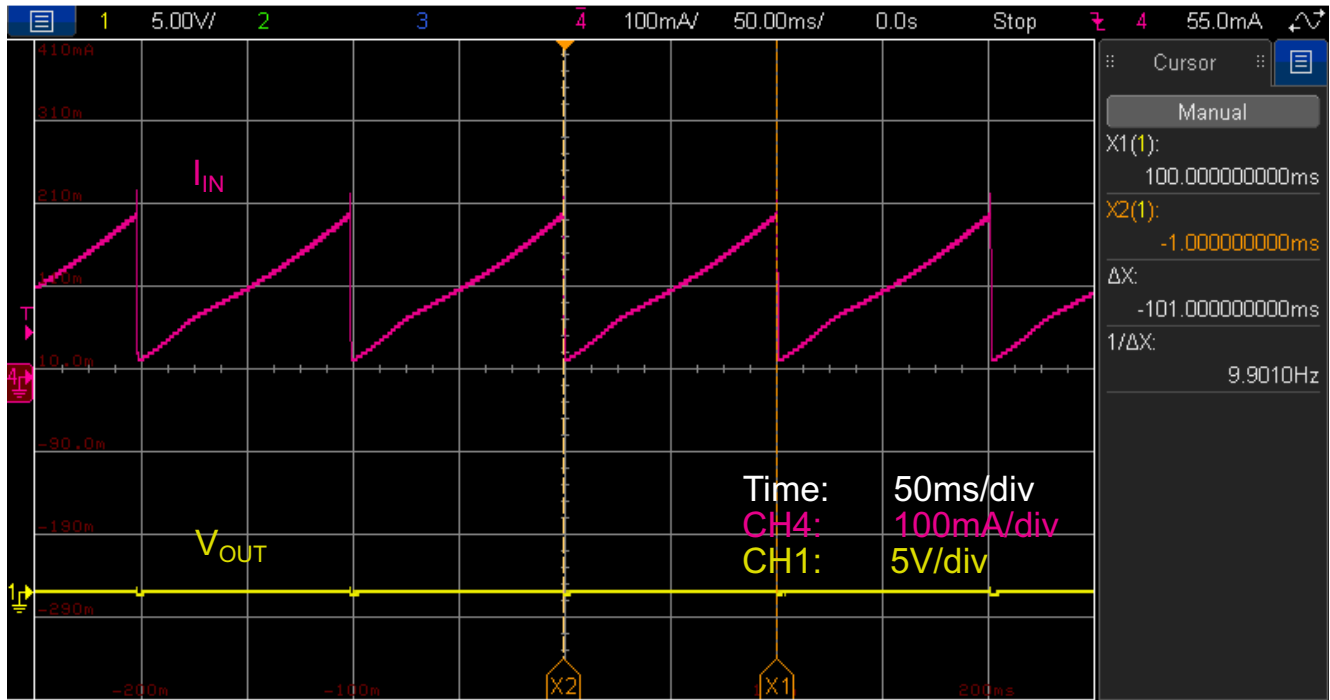

Figure 33. Si3406-ISO-FB EVB, 5 V, Class 2 Output Short Circuit Protection

4.11. Pulse Skipping at No-Load Condition

The Si3406 device has an integrated pulse skipping mechanism to ensure ultra-low power consumption at light load condition.

As the output load decreases, the controller starts to reduce the pulse-width of the PWM signal (switcher ON time). At some point, even the minimum width pulse would provide higher energy than the application requires, which could result in loss of voltage regulation.

When the controller detects light load condition (which requires less ON time than the minimum pulse width), the controller enters into pulse-skipping mode. This mode is shown in the following figure, which depicts the switching node of the integrated switching FET at a no load condition.

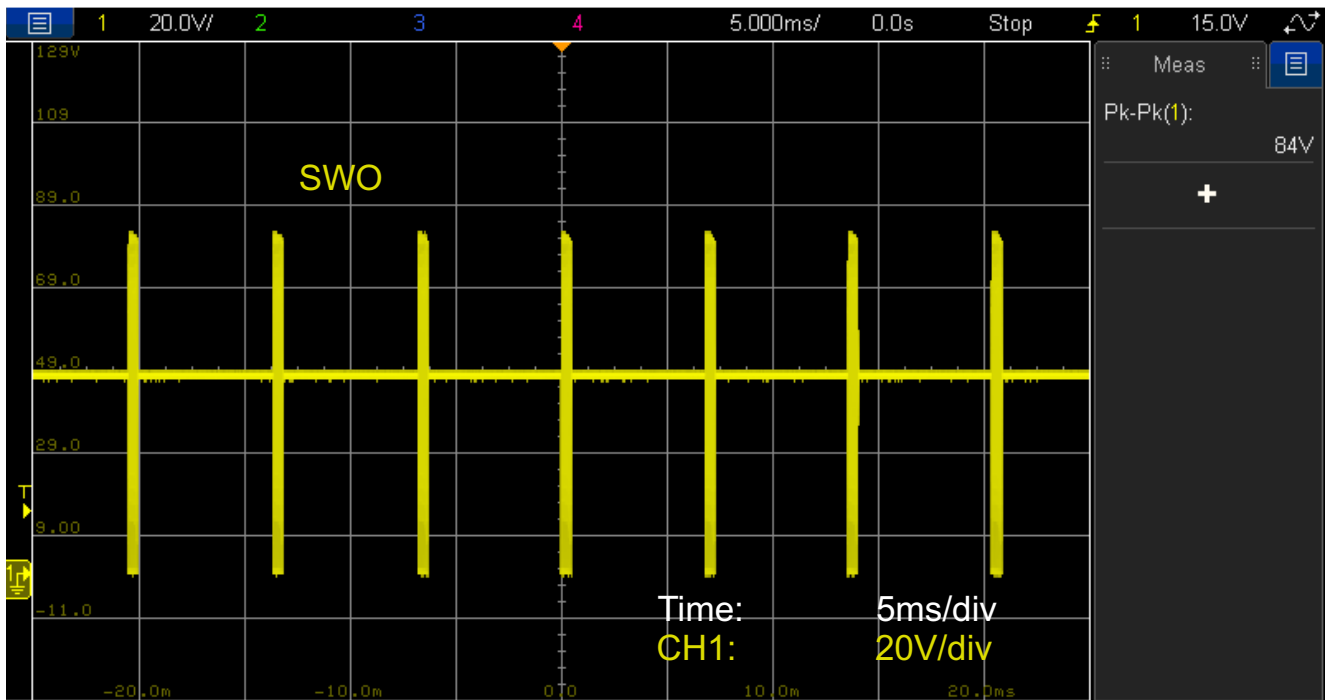

Figure 34. Si3406-ISO-FB EVB, 5 V, Class 2 Pulse Skipping at No-load Condition: SWO Waveform

4.12. Discontinuous (DCM) and Continuous (CCM) Conduction Modes

At low load, the converter works in discontinuous conduction mode (DCM). At heavy load, the converter runs in continuous conduction mode (CCM). At low load, the SWO voltage waveform has a ringing waveform, which is typical for DCM operation.

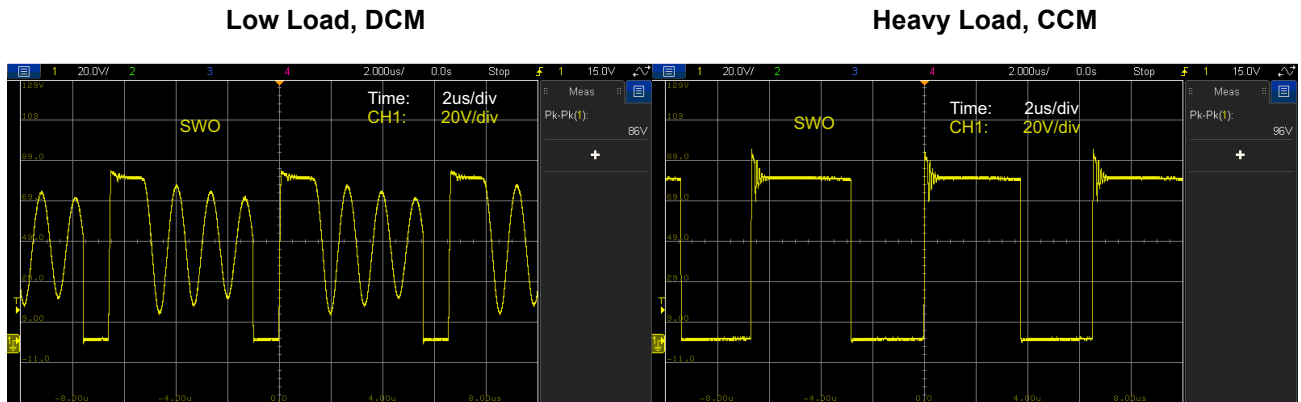

Figure 35. Si3406-ISO-FB EVB, 5 V, Class 2: SWO Waveform in Discontinuous Conduction Mode (DCM) at Low Load (Left), and in Continuous Conduction Mode (CCM) at Heavy Load (Right)

Similar voltage waveforms can be observed on the secondary side diode, D1. The voltage amplitudes on the secondary side diode, D1, are much lower due to the transformer turns ratio; however, the discontinuous and continuous conduction mode characteristics are still present.

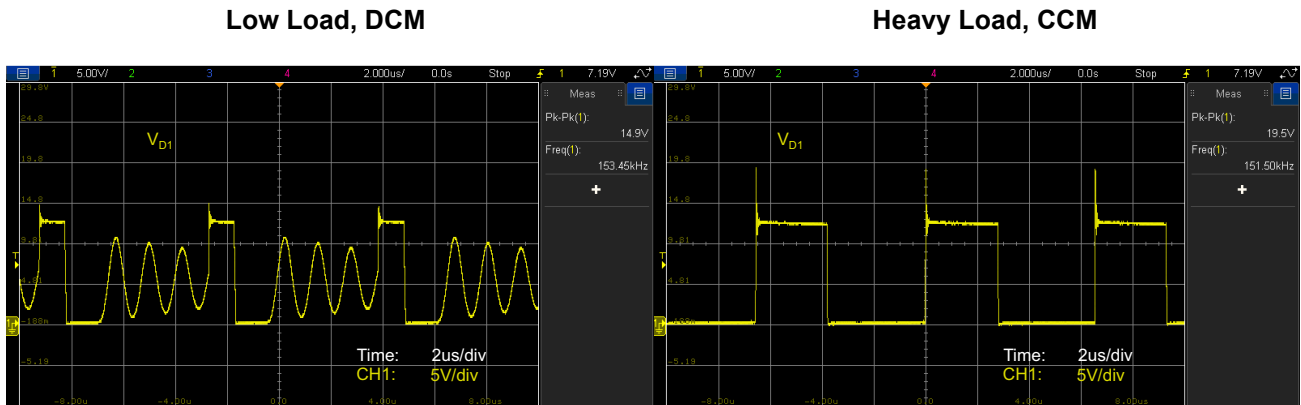

Figure 36. Si3406-ISO-FB EVB, 5 V, Class 2: Secondary Side Diode Voltage Waveform in Discontinuous Conduction Mode (DCM) at Low Load (Left), and in Continuous Conduction Mode (CCM) at Heavy Load (Right)

4.13. Maintain Power Signature (MPS)

The Si3406-ISO-FB EVB board has a built-in MPS feature which is enabled by default. The Si3406 maintains the connection with the PSE when the PD is in a low-current consumption mode. MPS can be used in user mode or in automatic mode. In user mode, nSLEEP shall be tied to VDD at startup (R13) and the host controller needs to manually start/stop MPS generation by pulling the nSLEEP line low or high respectively. To enable automatic MPS feature, nSLEEP shall be tied to VSS at startup (R15). In automatic mode, Si3406 monitors the input current and turns on MPS automatically when it falls below a predefined level.

Note: Si3406 assumes a minimum consumption of the host controller therefore to pass Sifos MPS tests, a dummy load has been installed on the EVB (R22) along with the pre-installed status LED to keep the consumption above the pre-defined current threshold. The figure below shows the automatic MPS pulses generated by the EVB with a 470 Ω dummy load installed at the output.

Automatic MPS Pulse Generation by Si3406
 $V_{ON} = 81.96 \text{ ms}$, $V_{OFF} = 147.1 \text{ ms}$, $I_{MAX} = 13.02 \text{ mA}$

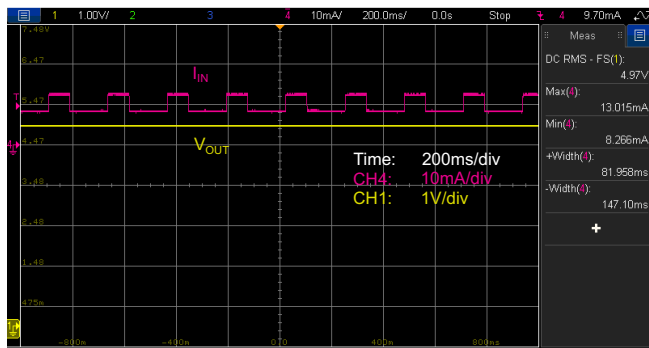

Automatic MPS pulse generation by Si3406
 Sifos start-up trace

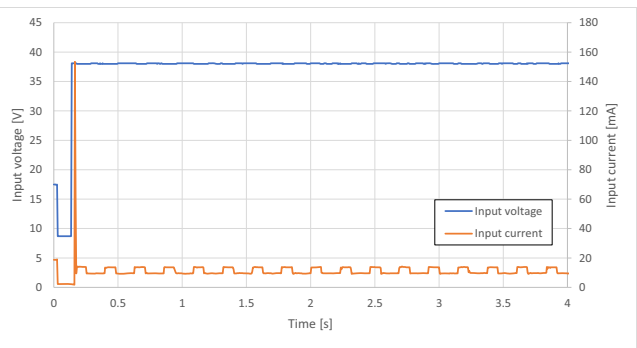

Figure 37. Si3406-ISO-FB EVB, 5 V, Class 2 PD Automatic Maintain Power Signature (MPS) Generation

4.14. (Optional) Secondary-Side Synchronous Rectification

The Si3406-ISO-FB EVB board has an option to include a Secondary-Side Synchronous Rectification which helps to increase overall efficiency. The necessary changes are indicated in Table 38.

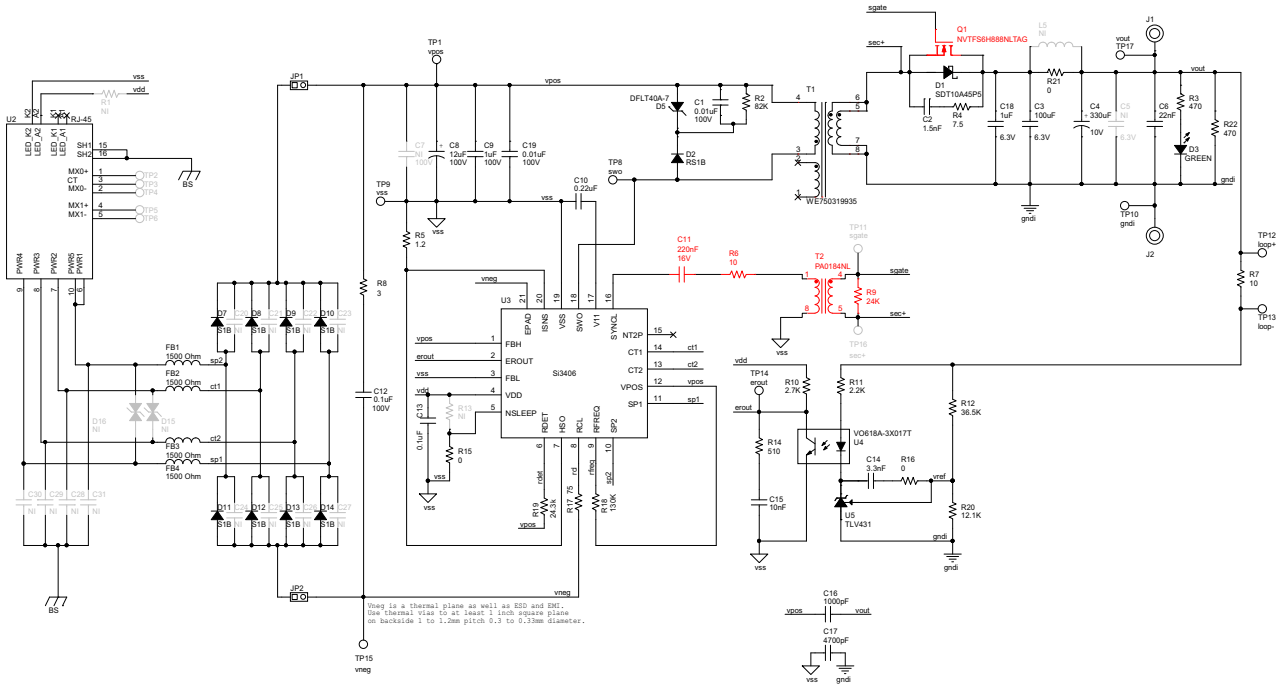

Figure 38. Si3406-ISO-FB EVB, 5 V, Class 2 Secondary-Side Synchronous Rectification Modifications

Figure 39 shows the efficiency improvement of the EVB with the NVTFS6H888NLTAG MOSFET installed. The efficiency was measured at three different input voltage levels: 40.8 V, 50 V, and 57 V.

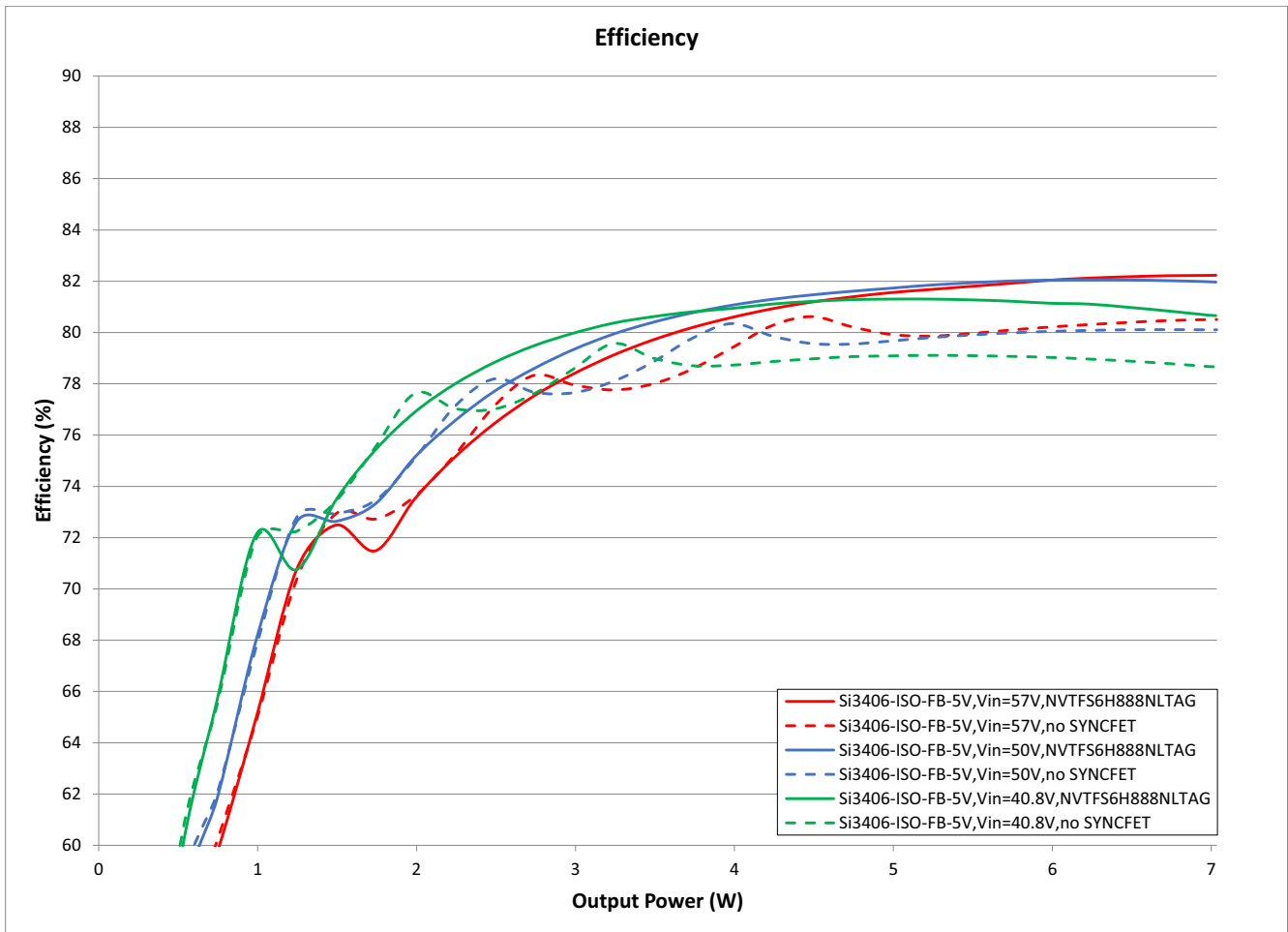

Figure 39. Si3406-ISO-FB End-to-End Efficiency Chart with Internal Input Bridge Diodes and Secondary-Side Synchronous Rectification: 40.8 V, 50 V and 57 V Input, 5 V Output, Class 2

4.15. Radiated Emissions Measurement Results

Radiated emissions of the Si3406-ISO-FB, 5 V, Class 2 EVB board have been measured with 50 V input voltage and a full load connected to the output. The input power was 6.5 W in this case.

As shown below, the Si3406-ISO-FB, 5 V, Class 2 EVB is fully compliant with the international EN 55032 Class B emissions standard.

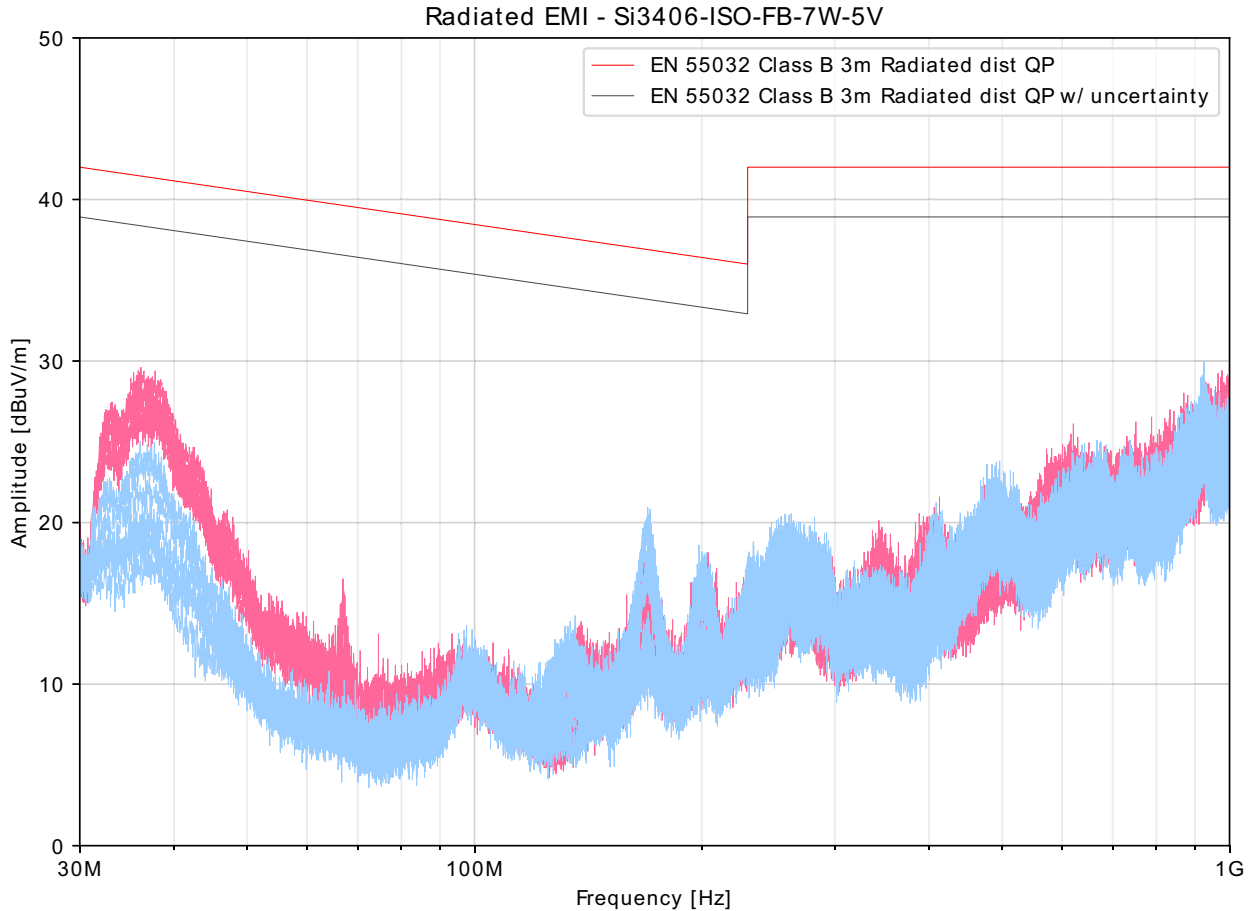

Figure 40. Si3406-ISO-FB EVB Radiated Emissions Measurements Results; 50 V Input, 5 V Output, 6.5 W Input Power

The EVB is measured at full load with peak detection in both vertical and horizontal polarizations. This is a relatively fast process that produces a red curve (vertical polarization) and a blue curve (horizontal polarization). The chamber was non-reflective and multiple measurements were made by rotating the table in 45 degrees steps. All these measurement results are displayed on the graph above.

Next, specific frequencies are selected for quasi-peak measurements if the peak detection shows significant violations. The board is measured again at those specific frequencies with a quasi-peak detector, which is a very slow but accurate measurement. The results of this quasi-peak detector measurement are the blue rhombuses (if any). These frequencies and the corresponding results are displayed in the table above if quasi-peak measurements are executed.

The red and blue curves and the blue rhombuses (if any) represent the final result of the measurement process. To have passing results, the blue rhombuses should be below the highlighted EN 55032 Class B limit.

4.16. Conducted Emissions Measurement Results

The Si3406-ISO-FB, 5 V, Class 2 EVB board's conducted emissions have been measured in two different measurement methods to comply with the international EN 55032 standard. The EVB is supplied and measured on its PoE input port as shown in Figure 41.

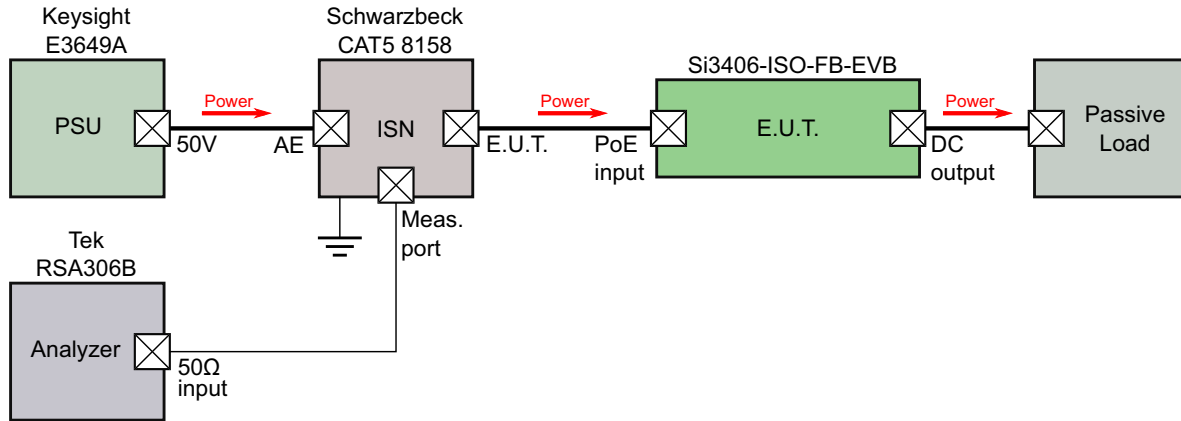

Figure 41. Conducted EMI Measurement Setup

The detector in the spectrum analyzer is set to:

- Peak detector and
- Average detector

Both results are shown in Figure 42:

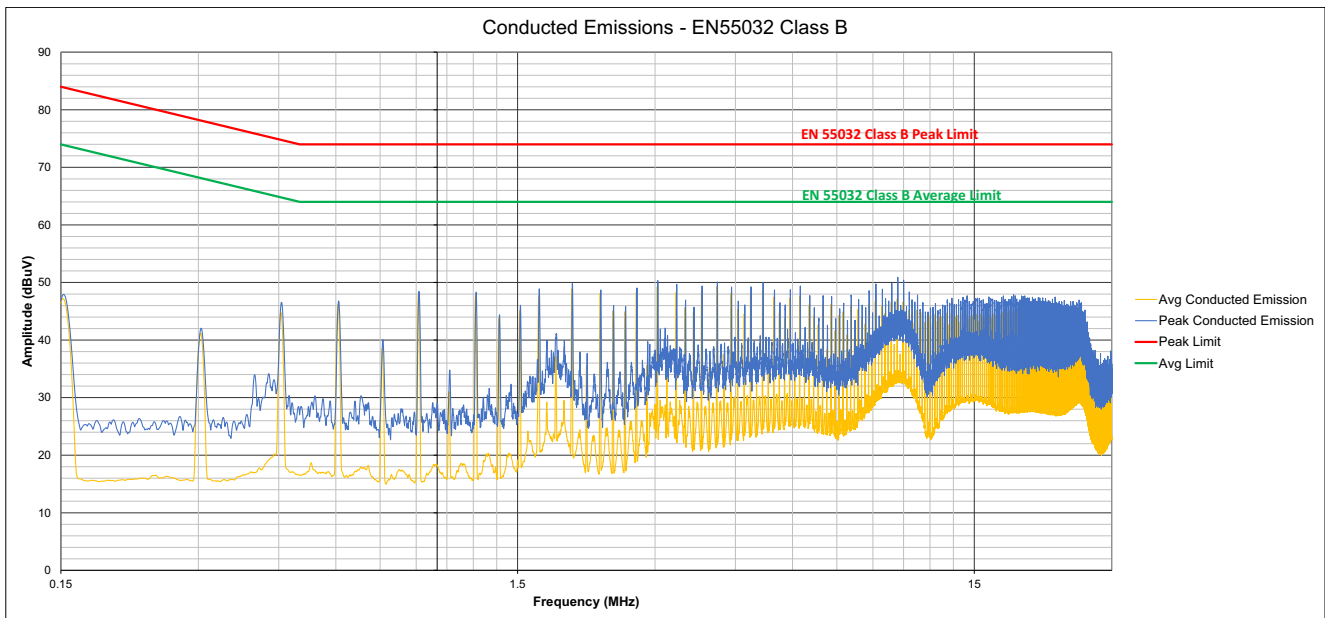

Figure 42. Si3406-ISO-FB EVB Conducted Emissions Measurements Results; 50 V Input, 5 V Output, 6.5 W Input Power

4.17. Bill of Materials

Table 13 is the BOM listing for the standard 5 V output evaluation board with Option PoE Class 2.

Table 13. Si3406 Isolated Flyback 5 V Bill of Materials

Qty	Reference	Value	Rating	Voltage	Tol	Type	PCB_Footprint	Mfr Part Number	Mfr
1	C1	0.01uF		100V	±10%	X7R	C0805	C0805X7R101-103K	Venkel
1	C10	0.22uF		16V	±10%	X7R	C0805	C0805X7R160-224KNE	Venkel
1	C12	0.1uF		100V	±10%	X7R	C0805	C0805X7R101-104K	Venkel
1	C13	0.1uF		16V	±10%	X7R	C0805	C0805X7R160-104K	Venkel
1	C14	3.3nF		50V	±5%	X7R	C0805	C0805X7R500-332JNE	Venkel
1	C15	10nF		50V	±1%	C0G	C0805	C0805C0G500-103F	Venkel
1	C16	1000pF		2000V	±5%	C0G	C1808	C1808C0G202-102JNE	Venkel
1	C17	4700pF		2000V	±10%	X7R	C1808	C1808X7R202-472KNE	Venkel
1	C18	1uF		6.3V	±10%	X5R	C0603	C0603X5R6R3-105K	Venkel
1	C19	0.01uF		100V	±10%	X7R	C0603	C0603X7R101-103K	Venkel
1	C2	1.5nF		100V	±10%	X7R	C0805	C0805X7R101-152K	Venkel
1	C3	100uF		6.3V	±10%	X5R	C1210	C1210X5R6R3-107K	Venkel
1	C4	330uF		10V	±20%	Alum_Elec	C3.5X8MM-RAD	860160274017	Wurth Elektronik
1	C6	22nF		25V	±5%	C0G	C0805	C0805C0G250-223J	Venkel
1	C8	12uF		100V	±20%	Alum_Elec	C2.5X6.3MM-RAD	EEUFC2A120	Panasonic
1	C9	1uF		100V	±10%	X7R	C1210	C1210X7R101-105K	Venkel
1	D1	SDT10A45P5	10A	45V		Schottky	POWERDI-5	SDT10A45P5-7	Diodes Inc.
1	D2	RS1B	1.0A	100V		Single	DO-214AC	RS1B	Fairchild
1	D3	GREEN					LED-0805-K-K1A2	XZVG54W-8	SunLED
1	D5	DFLT40A-7	3.49A	40V		Zener	POWERDI-123	DFLT40A-7	Diodes Inc.
8	D7 D8 D9 D10 D11 D12 D13 D14	S1B	1.0A	100V		Single	DO-214AC	S1B	Fairchild
4	FB1 FB2 FB3 FB4	1500 Ohm	1000mA			SMT	L0805	742792097	Wurth
2	J1 J2	BND_POST	15A			BANANA	BANANA-JACK	101	ABBATRON HH SMITH
2	JP1 JP2	HEADER 1X2				Header	CONN1X2	TSW-102-07-T-S	Samtec
1	LB1	LABEL-Si3406-EVB-ISO-FB-R4.2-5V				POLYIMIDE, WHITE	PTL-14-717	LABEL-Si3406-EVB-ISO-FB-R4.2-5V	Skyworks
4	MH1 MH2 MH3 MH4	4-40				SCREW	MH-125 MH-125NP	NSS-4-4-01	Richco Plastic Co
1	PCB1	Si3406-EVB-ISO-FB REV 4.0				BARE PCB	N/A	Si3406-EVB-ISO-FB REV 4.0	Skyworks
1	R10	2.7K	1/10W		±1%	ThickFilm	R0805	CR0805-10W-2701F	Venkel

Table 13. Si3406 Isolated Flyback 5 V Bill of Materials (Continued)

Qty	Reference	Value	Rating	Voltage	Tol	Type	PCB_Footprint	Mfr Part Number	Mfr
1	R11	2.2K	1/10W		±1%	ThickFilm	R0805	CR0805-10W-2201F	Venkel
1	R12	36.5K	1/10W		±1%	ThickFilm	R0805	CR0805-10W-3652F	Venkel
1	R14	510	1/10W		±1%	ThickFilm	R0805	CR0805-10W-5100F	Venkel
3	R15, R16, R21	0	2A			ThickFilm	R0805	CR0805-10W-000	Venkel
1	R17	75	1/10W		±1%	ThickFilm	R0805	CR0805-10W-75R0F	Venkel
1	R18	130K	1/10W		±1%	ThickFilm	R0805	CR0805-10W-1303F	Venkel
1	R19	24.3k	1/8W		±1%	ThickFilm	R0805	CRCW080524K3FKEA	vishay
1	R2	82K	1/10W		±5%	ThickFilm	R0805	CR0805-10W-823J	Venkel
1	R20	12.1K	1/10W		±1%	ThickFilm	R0805	CR0805-10W-1212F	Venkel
1	R22	470	1/4W		±1%	ThickFilm	R1206	CR1206-4W-4700F	Venkel
1	R3	470	1/10W		±1%	ThickFilm	R0805	CR0805-10W-4700F	Venkel
1	R4	7.5	1/8W		±1%	ThickFilm	R0805	CR0805-8W-7R50F	Venkel
1	R5	1.2	1/10W		±5%	ThickFilm	R0805	CR0805-10W-1R2J	Venkel
1	R7	10	1/10W		±1%	ThickFilm	R0805	CR0805-10W-10R0F	Venkel
1	R8	3	1/8W		±1%	ThickFilm	R0805	CR0805-8W-3R00FT	Venkel
4	SO1, SO2, SO3, SO4	STANDOFF				STANDOFF		2397	SPC Technology
1	T1	750319935		5V		FLYBACK	XFMR-EP10	750319935	Würth Elektronik
3	TP1, TP12, TP17	RED				LOOP	TESTPOINT	5000	Keystone
6	TP8, TP9, TP10, TP13, TP14, TP15	BLACK				LOOP	TESTPOINT	5001	Keystone
1	U2	RJ-45				Receptacle	RJ45-74982104400	74982104400	Würth Elektronik
1	U3	Si3406		120V		PD	QFN20N5X5P0.8	Si3406-A-GM	Skyworks
1	U4	VO618A-3X017T					SO4N10.16P2.54-AKEC	VO618A-3X017T	Vishay
1	U5	TLV431				SHUNT	TLV431-DBZ	TLV431BCDBZR	TI
Not Installed Components									
1	C11	0.22uF		16V	±10%	X7R	C0805	C0805X7R160-224KNE	Venkel
8	C20, C21, C22, C23, C24, C25, C26, C27	1nF		100V	±10%	X7R	C0603	C0603X7R101-102K	Venkel
4	C28, C29, C30, C31	1nF		2000V	±5%	X7R	C1206	C1206C102JGRACU	Kemet
1	C5	100uF		6.3V	±10%	X5R	C1210	C1210X5R6R3-107K	Venkel
1	C7	1uF		100V	±10%	X7R	C1210	C1210X7R101-105K	Venkel
2	D15, D16	SMAJ58CA	400W	58V		TVS	DO-214AC	SMAJ58CA	Littelfuse
1	L5	1uH	2.4A		±20%	Shielded	L0805	TFM201208ALD-1R0MTCA	TDK
1	Q1	NVTF56H888NLTAG	14A	80V		N-CHNL	POWER33	NVTF56H888NLTAG	ON Semiconductor

Table 13. Si3406 Isolated Flyback 5 V Bill of Materials (Continued)

Qty	Reference	Value	Rating	Voltage	Tol	Type	PCB_Footprint	Mfr Part Number	Mfr
1	R1	1K	1/10W		±1%	ThickFilm	R0805	CR0805-10W-1001F	Venkel
1	R13	0	2A			ThickFilm	R0805	CR0805-10W-000	Venkel
1	R6	10	1/10W		±1%	ThickFilm	R0805	CR0805-10W-10R0F	Venkel
1	R9	24K	1/10W		±1%	ThickFilm	R0805	CR0805-10W-2402FT	Venkel
1	T2	1200uH	none	1500V	none		XFMR-PA0184NL	PA0184NL	Pulse Engineering
7	TP2, TP3, TP4, TP5, TP6, TP11, TP16	BLACK				LOOP	TESTPOINT	5001	Keystone

5. Si3406-ISO-FB EVB: 12 V, Class 2 Configuration

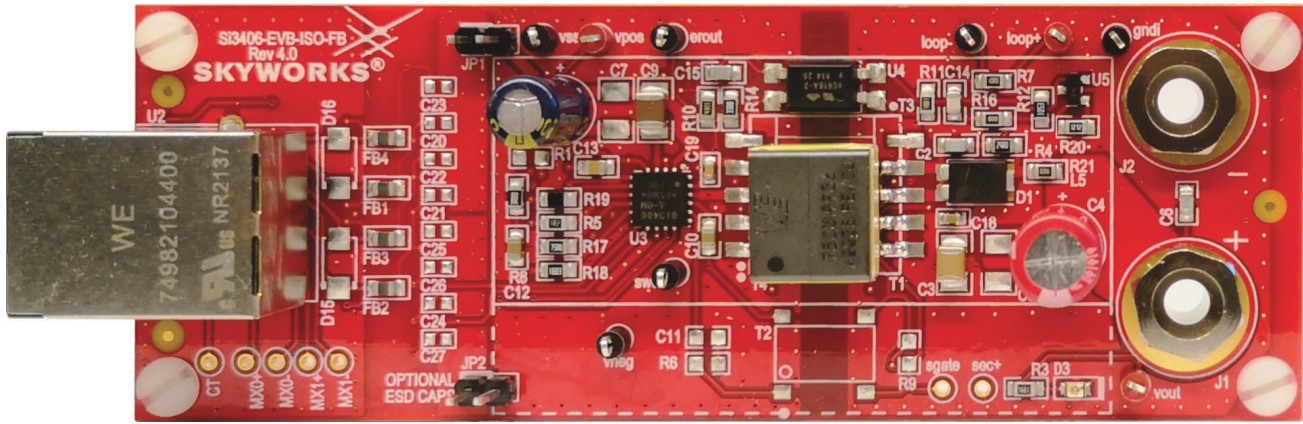

Figure 43. Si3406-ISO-FB EVB 12 V Board

5.1. Si3406-ISO-FB EVB Schematic: 12 V, Class 2, 7W

The figure below shows the schematic of the Si3406-ISO-FB 12 V, Class 2 EVB. The parts in red on the schematic represent the BOM differences compared to the other output voltage variants of this EVB. The parts in gray are not installed on the EVB, but they have footprints.

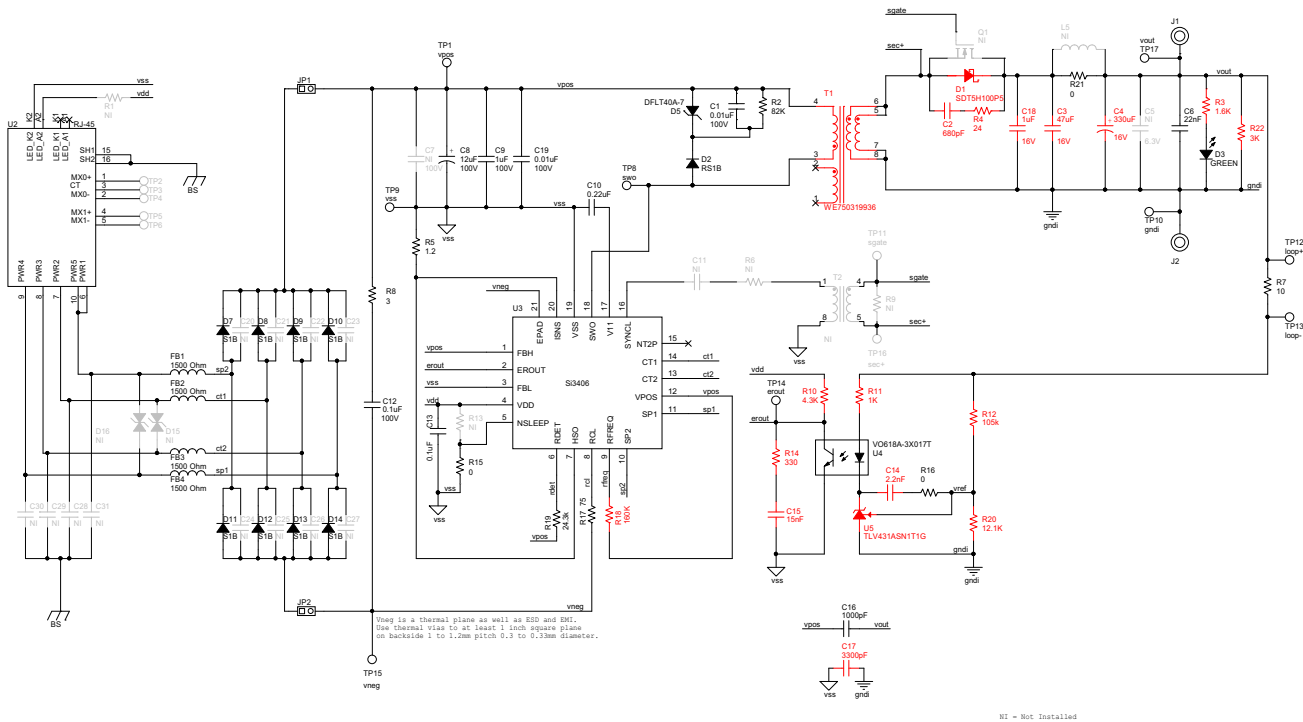

Figure 44. Si3406-ISO-FB Isolated EVB Schematic: 12 V, Class 2 PD, 7 W

5.2. End-to-End EVB Efficiency

The end-to-end conversion efficiency measurement data of the Si3406 12 V ISO-FB board is shown in the figure below with internal and external (S1B) input bridges. Efficiency was measured from PoE (RJ45 connector) input to the 12 V output. The efficiency was measured at three different input voltage levels: 40.8 V, 50 V, and 57 V.

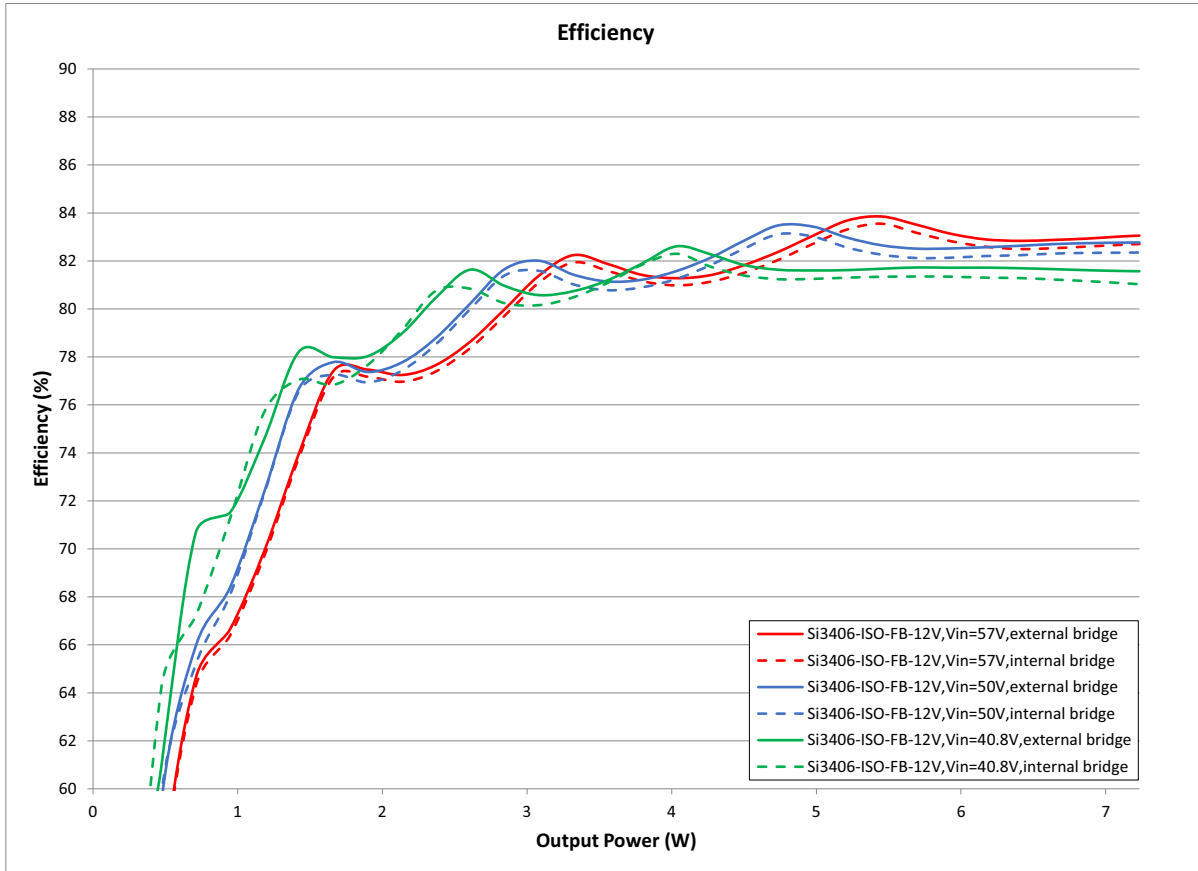

Figure 45. Si3406-ISO-FB End-to-End Efficiency Chart with Internal and External (S1B) Input Bridge Diodes: 40.8V, 50 V and 57V Input, 12 V Output, Class 2

Note The chart shows end-to-end EVB efficiency. The voltage drop of the diode bridge is included. Indicator LEDs are removed as they are not part of the power conversion.

5.3. Thermal Measurements

The Si3406-ISO-FB EVB’s temperature was measured at maximum **input power – 6.5 W**. The Si3406-ISO-FB EVB is configured for 12 V output voltage and Class 2 power level. Figure 3 shows the thermal images taken of the EVB board at maximum input power.

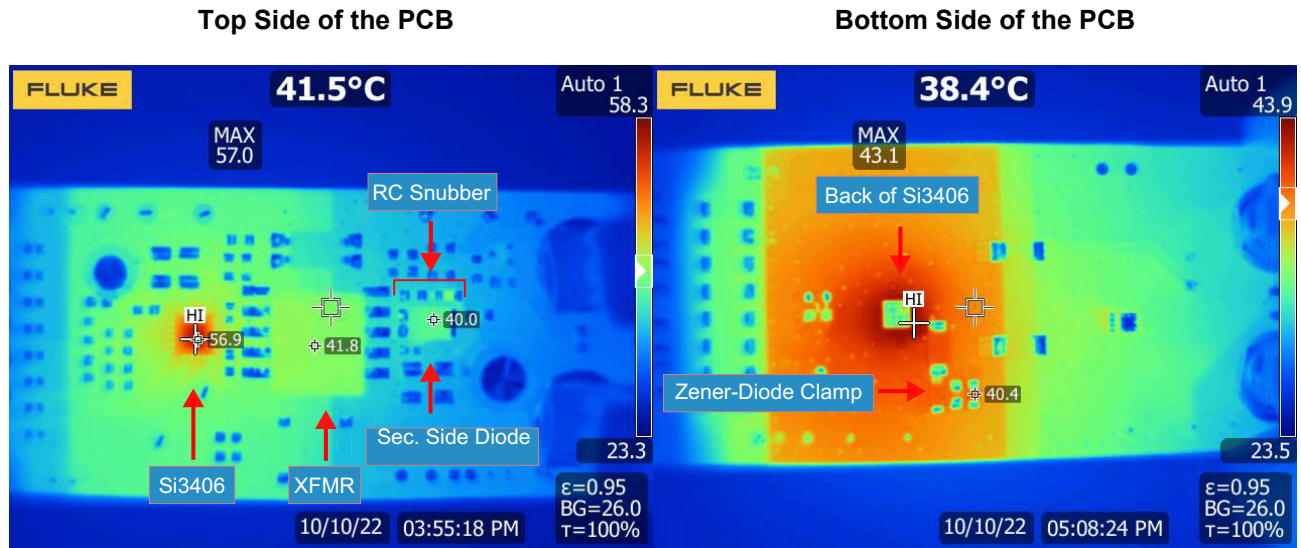

Figure 46. Thermal Measurements of the Si3406-ISO-FB Isolated EVB, 12 V, Class 2 PD

Table 14 lists the temperatures of notable components across the board.

Table 14. Component Temperatures at Full Load

Component	Temperature ¹
Si3406 – U3	56.9 °C
Flyback Transformer – T1	41.8 °C
Secondary Side Diode – D1	40.0 °C
Primary Side Zener Diode Clamp – D4-D5	40.4 °C
Note:	
1. The ambient temperature was 26 °C during the thermal measurements.	

5.4. SIFOS PoE Compatibility Test Results

The PDA-604A Powered Device Analyzer is a single-box comprehensive solution for testing IEEE 802.3at and IEEE 802.3bt PoE Powered Devices (PDs). The Si3406-ISO-FB 12 V EVB board has been successfully tested with the PDA-604A Powered Device Analyzer from Sifos Technologies.

See “11. Complete 12 V Si3406 Isolated Flyback Sifos Compatibility Test Reports” on page 84.

5.5. Adjustable EVB Current Limit

For additional safety, the Si3406 has an adjustable EVB current limit feature.

The Si3406 controller measures the voltage on the R_{SENSE} resistor (R5) through the ISNS pin. Care must be taken that this voltage goes below V_{SS} . When the voltage on the R5 is $V_{ISNS} = -270$ mV (referenced to V_{SS}), the internal current limit circuit restarts the PD to protect the application.

The EVB current limit for this Class 2 application can be calculated with the following formula:

$$R_{SENSE} = 1.2 \Omega$$
$$I_{LIMIT} = \frac{270 \text{ mV}}{1.2 \Omega} = 225 \text{ mA}$$

Equation 3. EVB Class 2 Current Limit

5.6. Feedback Loop Phase and Gain Measurement Results (Bode Plots)

The Si3406 device integrates a current-mode-controlled switching mode power supply controller circuit. Therefore, the application is a closed-loop system. To guarantee stable output voltage of the power supply and to reduce the influence of the input voltage variations and load changes on the output voltage, the feedback loop should be stable.

To verify the stability of the loop, the gain and phase of the loop has been measured.

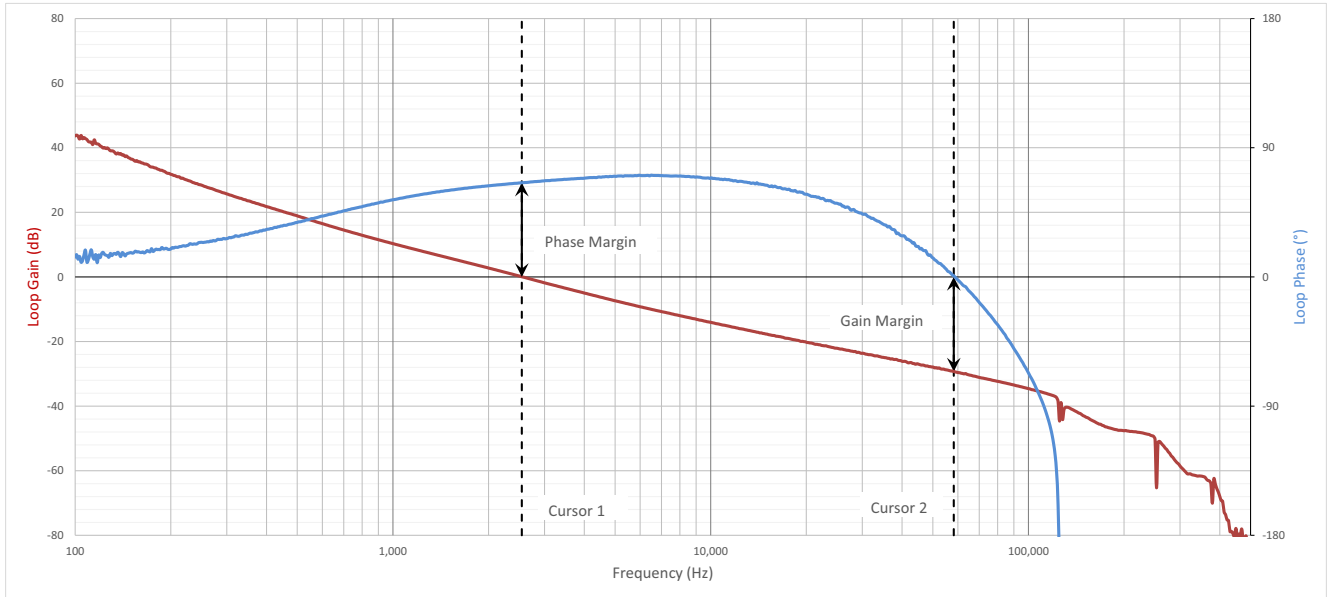

Figure 47. Si3406-ISO-FB Isolated EVB, 12 V, Class 2 PD Feedback Loop Measurement Results at Light Load

Table 15. Measured Loop Gain and Phase Margin at Light Load

	Frequency	Gain	Phase
Cursor 1 (Phase Margin)	2.54 kHz	0 dB	65.64°
Cursor 2 (Gain Margin)	58.21 kHz	29.27 dB	0°

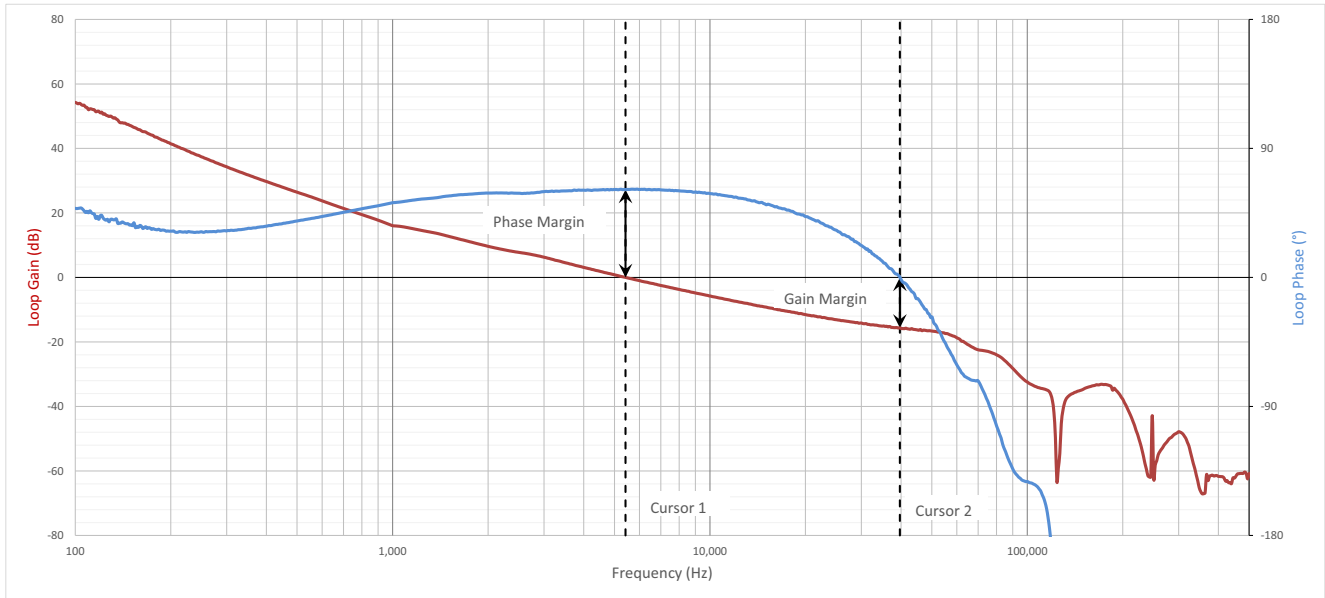

Figure 48. Si3406-ISO-FB Isolated EVB, 12 V, Class 2 PD Feedback Loop Measurement Results at Full Load

Table 16. Measured Loop Gain and Phase Margin at Full Load

	Frequency	Gain	Phase
Cursor 1 (Phase Margin)	5.42 kHz	0 dB	61.3°
Cursor 2 (Gain Margin)	39.68 kHz	15.63 dB	0°

The following table sums up the circumstances of the feedback loop measurements.

Table 17. Feedback Loop Measurement Circumstances

Measurement Name	Input Voltage	Output Load
Feedback Loop Measurement at Light Load	50 V	100 Ω
Feedback Loop Measurement at Full Load	50 V	24.98 Ω

5.7. Load Step Transient Measurement Results

The output of the Si3406-ISO-FB EVB board's output has been tested with a load step function to verify the converter's output dynamic response.

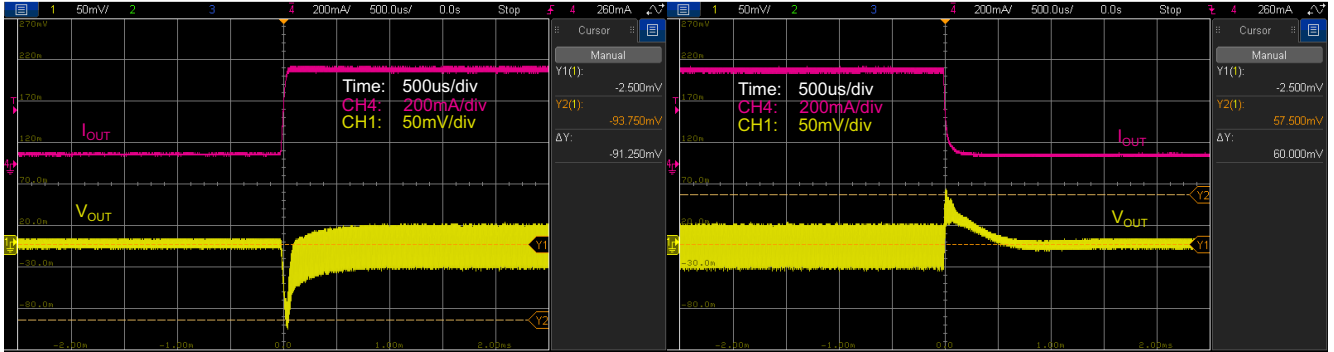

Figure 49. Si3406-ISO-FB EVB, 12 V, Class 2 PD Output Load Step Transient Test

Table 18 sums up the results of the load step measurements.

Table 18. Output Load Step Transient Results

Measurement Name	From (Output Current)	To (Output Current)	Slew Rate (Output Current)	VOUT Change
Stepping up the load	0.04 A	0.45 A	2500 mA/μs	12 V – 91.25 mV
Stepping down the load	0.45 A	0.04 A	2500 mA/μs	12 V + 60 mV

5.8. Output Voltage Ripple

The Si3406-ISO-FB EVB output voltage ripple has been measured under both No-Load and Heavy-Load conditions.

No-Load V_{OUT} Ripple = 11.73 mV

Heavy-Load V_{OUT} Ripple = 118.13 mV

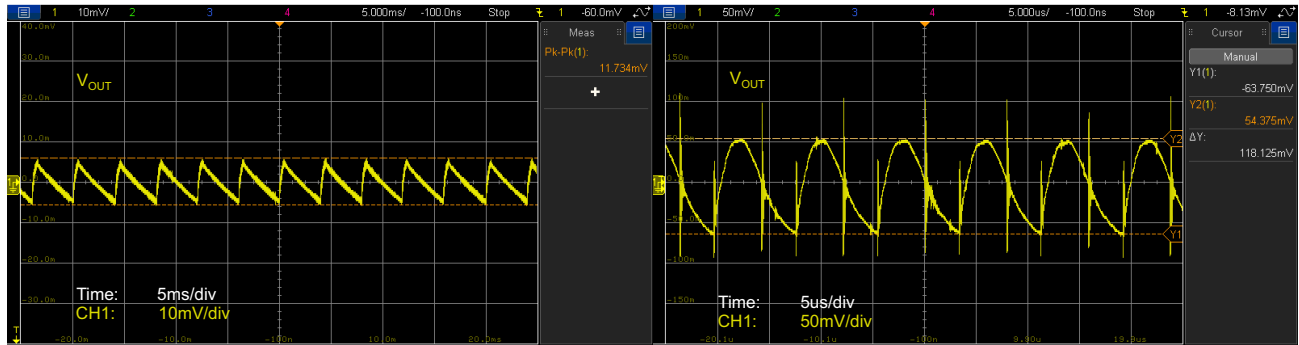

Figure 50. Si3406-ISO-FB EVB, 12 V, Class 2 Output Voltage Ripple No Load (Left) and Heavy Load (Right) Conditions

5.9. Soft-Start Protection

The Si3406 device has an integrated dynamic soft-start protection mechanism to avoid stressing the components by the sudden current or voltage changes associated with the initial charging of the output capacitors.

The Si3406 intelligent adaptive soft-start mechanism does not require any external component to be installed. The controller continuously measures the input current of the PD and dynamically adjusts the internal I_{PEAK} limit during soft-start, thus adjusting the output voltage ramp-up time as a function of the attached load.

The controller allows the output voltage to rise faster in no load (or light load) condition. With heavy load at the output, the controller slows down the output voltage ramp to avoid exceeding the desired regulated output voltage value.

No-load Soft-Start $t_{RISE} = 18$ ms

Heavy-load Soft-Start $t_{RISE} = 53.4$ ms

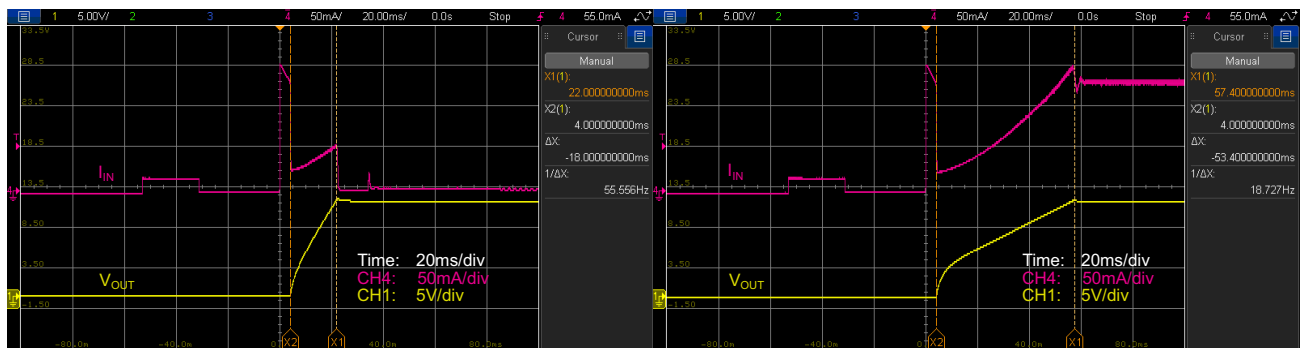

Figure 51. Si3406-ISO-FB EVB, 12 V, Class 2 Output Voltage Soft-Start at Low Load (Left) and Heavy Load (Right) Conditions

5.10. Output Short Protection

The Si3406 has an integrated output short protection mechanism, which protects the IC and surrounding external components from overheating in the case of an electrical short on the output.

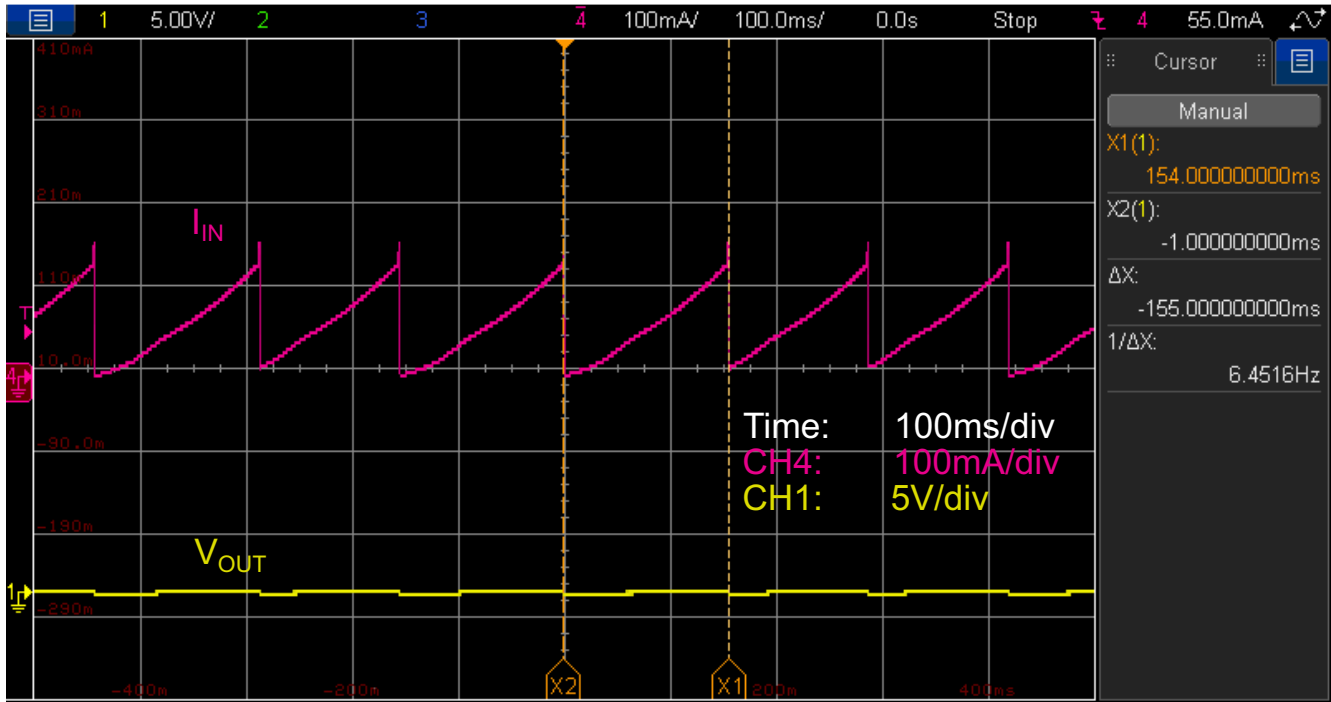

Figure 52. Si3406-ISO-FB EVB, 12 V, Class 2 Output Short Circuit Protection

5.11. Pulse Skipping at No-Load Condition

The Si3406 device has an integrated pulse skipping mechanism to ensure ultra-low power consumption at light load condition.

As the output load decreases, the controller starts to reduce the pulse-width of the PWM signal (switcher ON time). At some point, even the minimum width pulse would provide higher energy than the application requires, which could result in loss of voltage regulation.

When the controller detects light load condition (which requires less ON time than the minimum pulse width), the controller enters into pulse-skipping mode. This mode is shown in the following figure, which depicts the switching node of the integrated switching FET at a no load condition.

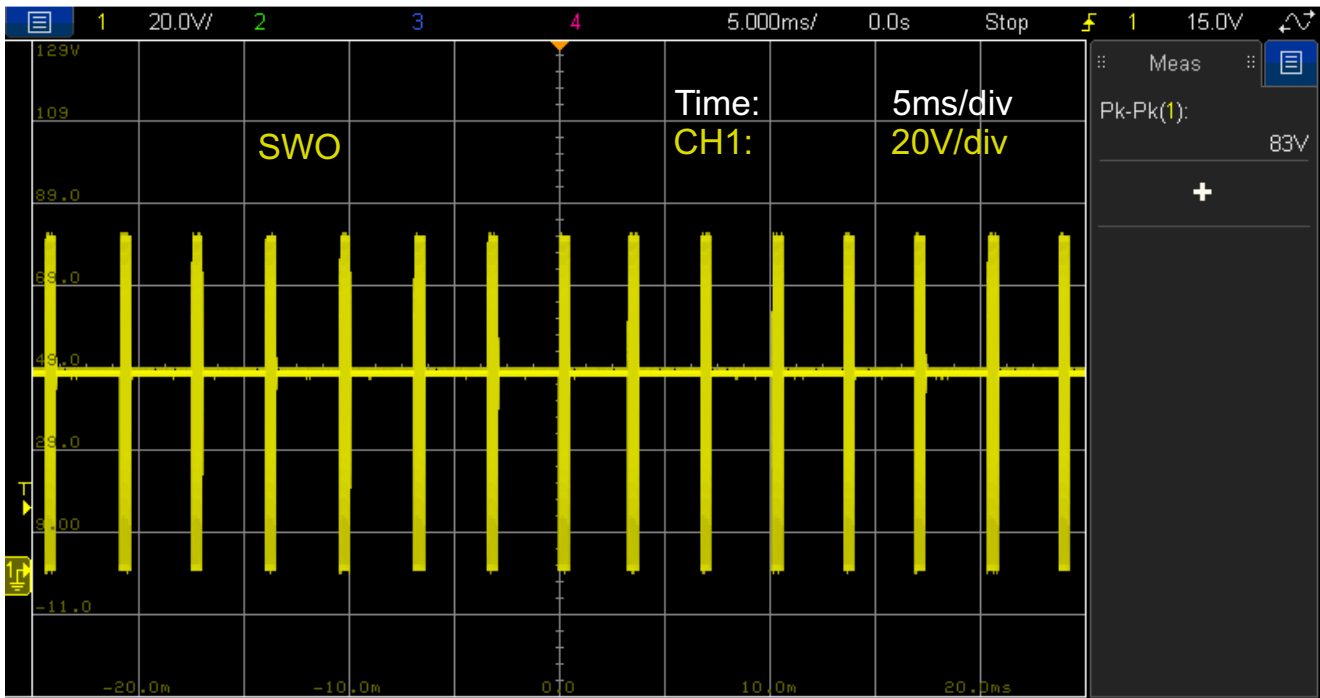

Figure 53. Si3406-ISO-FB EVB, 12 V, Class 2 Pulse Skipping at No-load Condition: SWO Waveform

5.12. Discontinuous (DCM) and Continuous (CCM) Conduction Modes

At low load, the converter works in discontinuous conduction mode (DCM). At heavy load, the converter runs in continuous conduction mode (CCM). At low load, the SWO voltage waveform has a ringing waveform, which is typical for DCM operation.

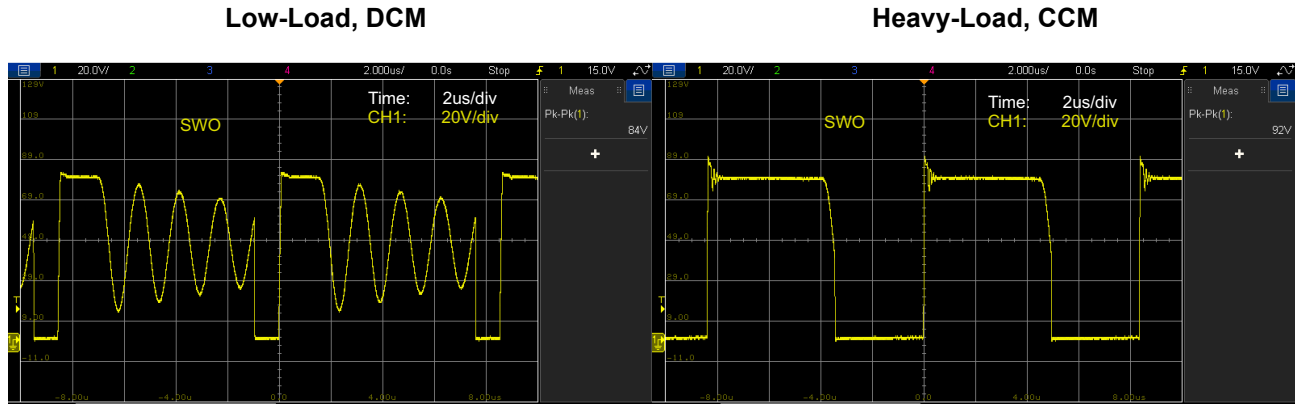

Figure 54. Si3406-ISO-FB EVB, 12 V, Class 2: SWO Waveform in Discontinuous Conduction Mode (DCM) at Low Load (Left), and in Continuous Conduction Mode (CCM) at Heavy Load (Right)

Similar voltage waveforms can be observed on the secondary side diode, D1. The voltage amplitudes on the secondary side diode, D1, are much lower due to the transformer turns ratio; however, the discontinuous and continuous conduction mode characteristics are still present.

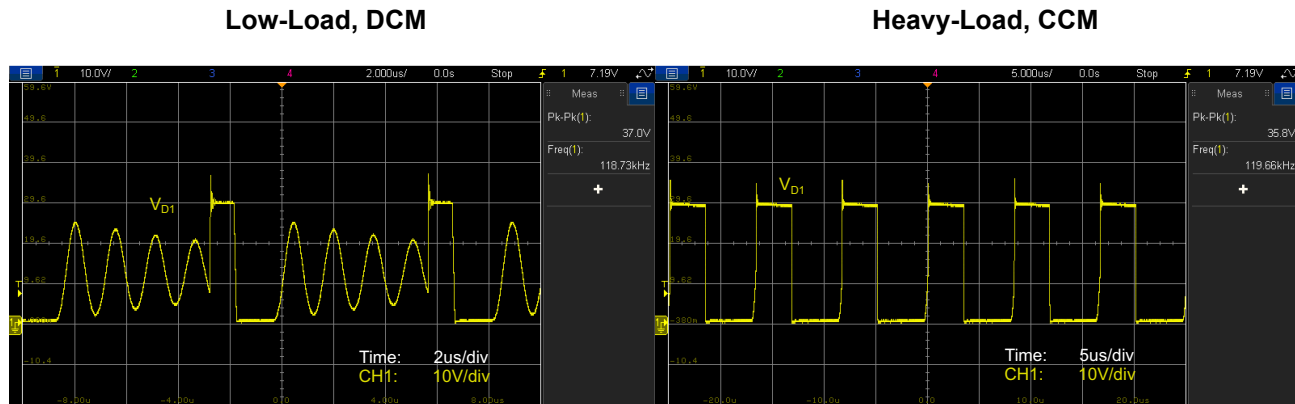

Figure 55. Si3406-ISO-FB EVB, 12 V, Class 2: Secondary Side Diode Voltage Waveform in Discontinuous Conduction Mode (DCM) at Low Load (Left), and in Continuous Conduction Mode (CCM) at Heavy Load (Right)

5.13. Maintain Power Signature (MPS)

The Si3406-ISO-FB EVB board has a built-in MPS feature which is enabled by default. The Si3406 maintains the connection with the PSE when the PD is in a low-current consumption mode. MPS can be used in user mode or in automatic mode. In user mode, nSLEEP shall be tied to VDD at startup (R13) and the host controller needs to manually start/stop MPS generation by pulling the nSLEEP line low or high respectively. To enable automatic MPS feature, nSLEEP shall be tied to VSS at startup (R15). In automatic mode, Si3406 monitors the input current and turns on MPS automatically when it falls below a predefined level.

Note: Si3406 assumes a minimum consumption of the host controller therefore to pass Sifos MPS tests, a dummy load has been installed on the EVB (R22) along with the pre-installed status LED to keep the consumption above the pre-defined current threshold. The figure below shows the automatic MPS pulses generated by the EVB with a 3 kΩ dummy load installed at the output.

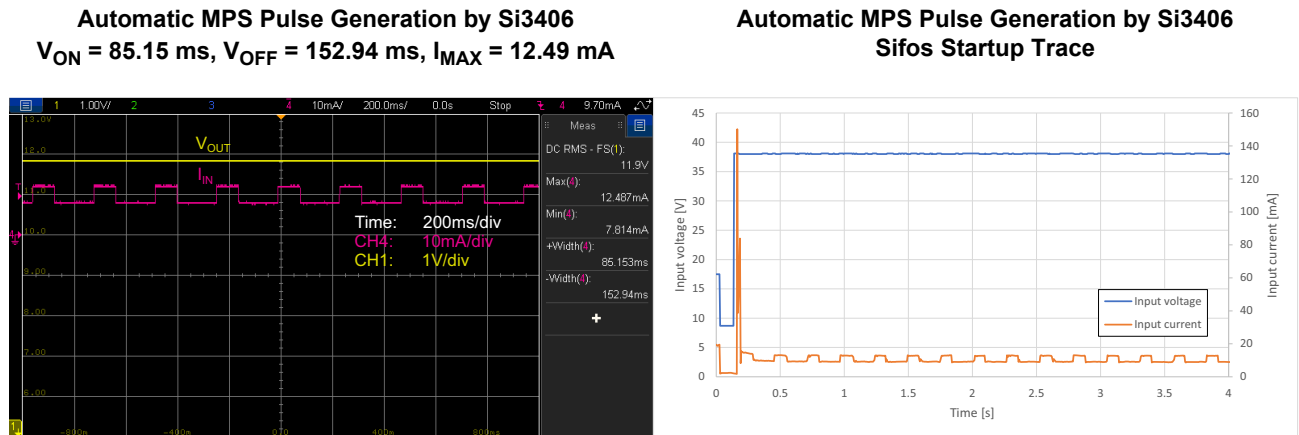

Figure 56. Si3406-ISO-FB EVB, 12 V, Class 2 PD Automatic Maintain Power Signature (MPS) Generation

5.14. (Optional) Secondary-Side Synchronous Rectification

The Si3406-ISO-FB EVB board has an option to include a Secondary-Side Synchronous Rectification which helps to increase overall efficiency. The necessary changes are indicated in the figure below.

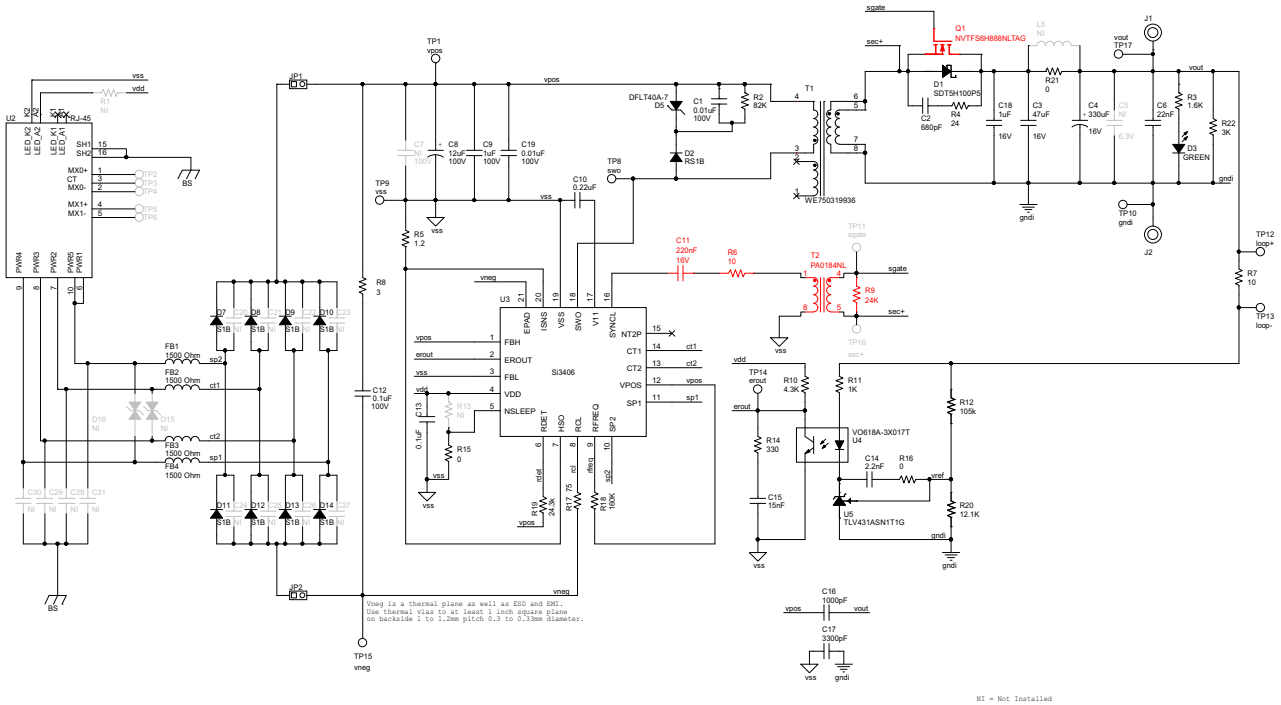

Figure 57. Si3406-ISO-FB EVB, 12 V, Class 2 Secondary-Side Synchronous Rectification Modifications

Figure 58 shows the efficiency improvement of the EVB with the NVTFS6H888NLTAG MOSFET installed. The efficiency was measured at three different input voltage levels: 40.8 V, 50 V, and 57 V.

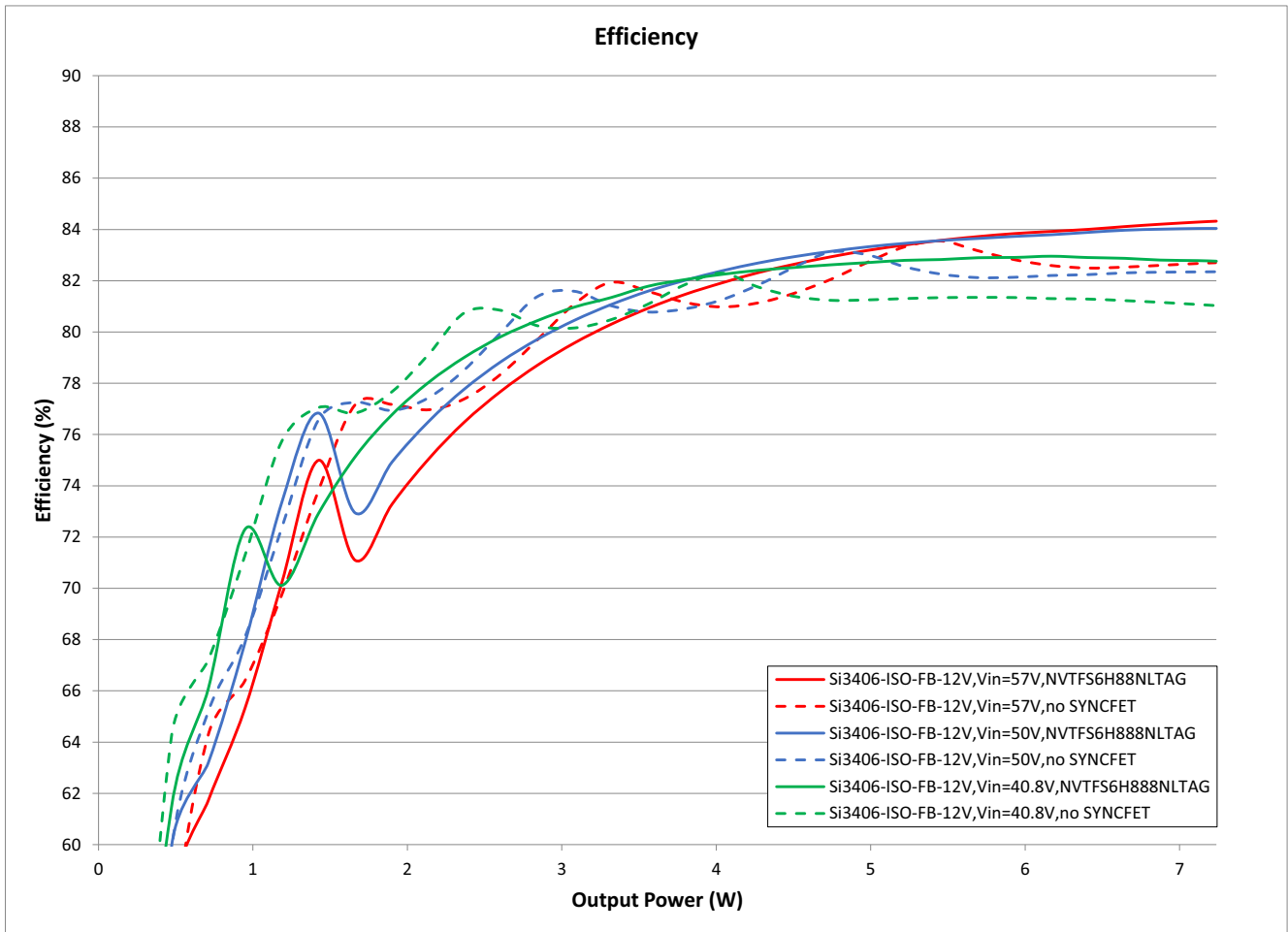

Figure 58. Si3406-ISO-FB End-to-End Efficiency Chart with Internal Input Bridge Diodes and Secondary-Side Synchronous Rectification: 40.8 V, 50 V and 57 V Input, 12 V Output, Class 2

5.15. Radiated Emissions Measurement Results

Radiated emissions of the Si3406-ISO-FB, 12 V, Class 2 EVB board have been measured with 50 V input voltage and a full load connected to the output. The input power was 6.5 W in this case.

As shown below, the Si3406-ISO-FB, 12 V, Class 2 EVB is fully compliant with the international EN 55032 Class B emissions standard.

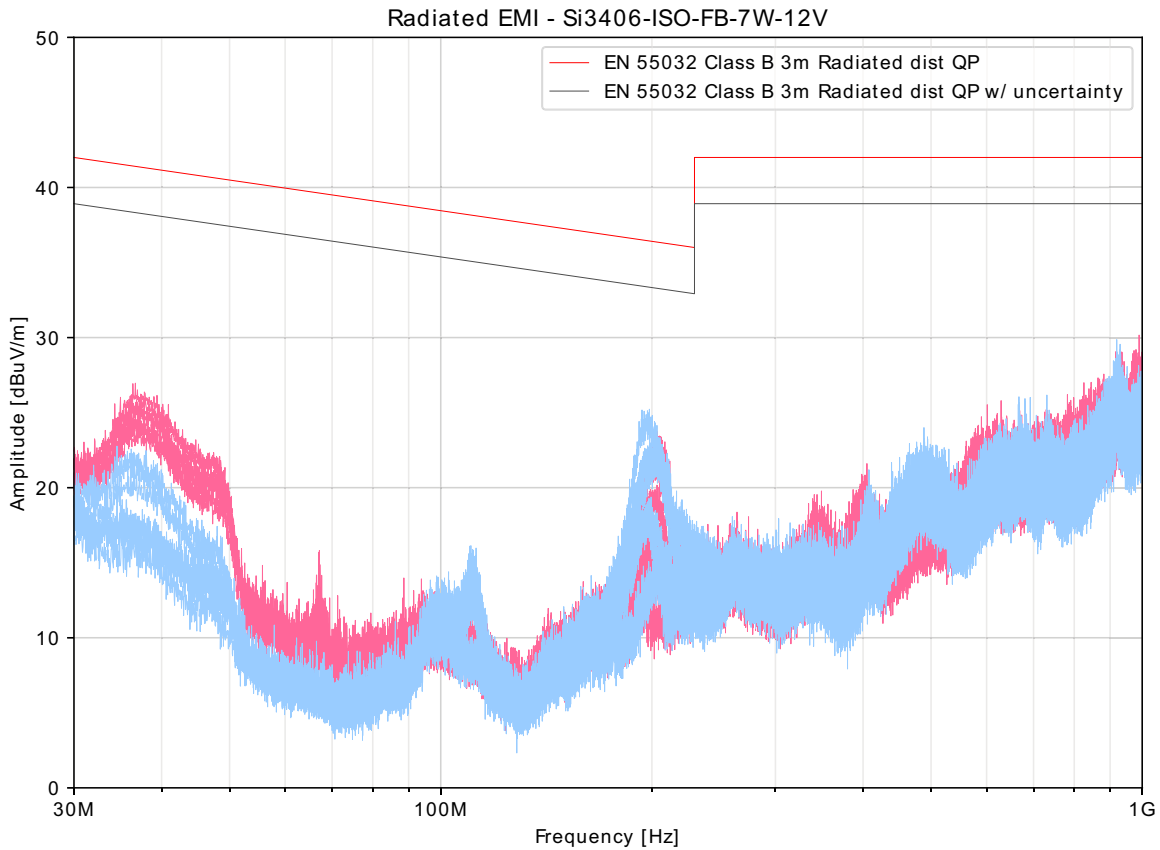

Figure 59. Si3406-ISO-FB EVB Radiated Emissions Measurements Results: 50 V Input, 12 V Output, 6.5 W Input Power

The EVB is measured at full load with peak detection in both vertical and horizontal polarizations. This is a relatively fast process that produces a red curve (vertical polarization) and a blue curve (horizontal polarization). The chamber was non-reflective and multiple measurements were made by rotating the table in steps of 45 degrees. All these measurement results are displayed on the graph above.

Next, specific frequencies are selected for quasi-peak measurements if the peak detection shows significant violations. The board is measured again at those specific frequencies with a quasi-peak detector, which is a very slow but accurate measurement. The results of this quasi-peak detector measurement are the blue rhombuses (if any). These frequencies and the corresponding results are displayed in the table above if quasi-peak measurements are executed.

The red and blue curves and the blue rhombuses (if any) represent the final result of the measurement process. To have passing results, the blue rhombuses should be below the highlighted EN 55032 Class B limit.

5.16. Conducted Emissions Measurement Results

The Si3406-ISO-FB, 12 V, Class 2 EVB board's conducted emissions have been measured in two different measurement methods to comply with the international EN 55032 standard. The EVB is supplied and measured on its PoE input port as shown in Figure 60.

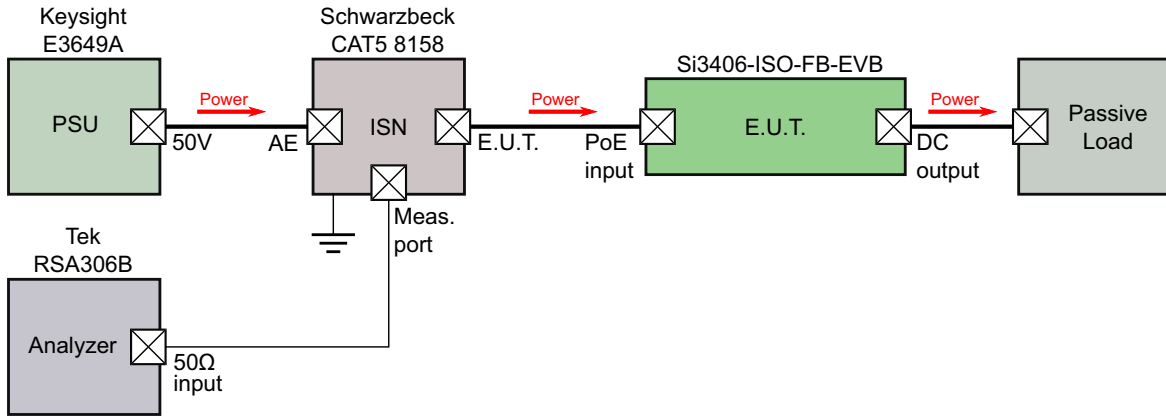

Figure 60. Conducted EMI Measurement Setup

The detector in the spectrum analyzer is set to:

- Peak detector and
- Average detector

Both results are shown in Figure 61:

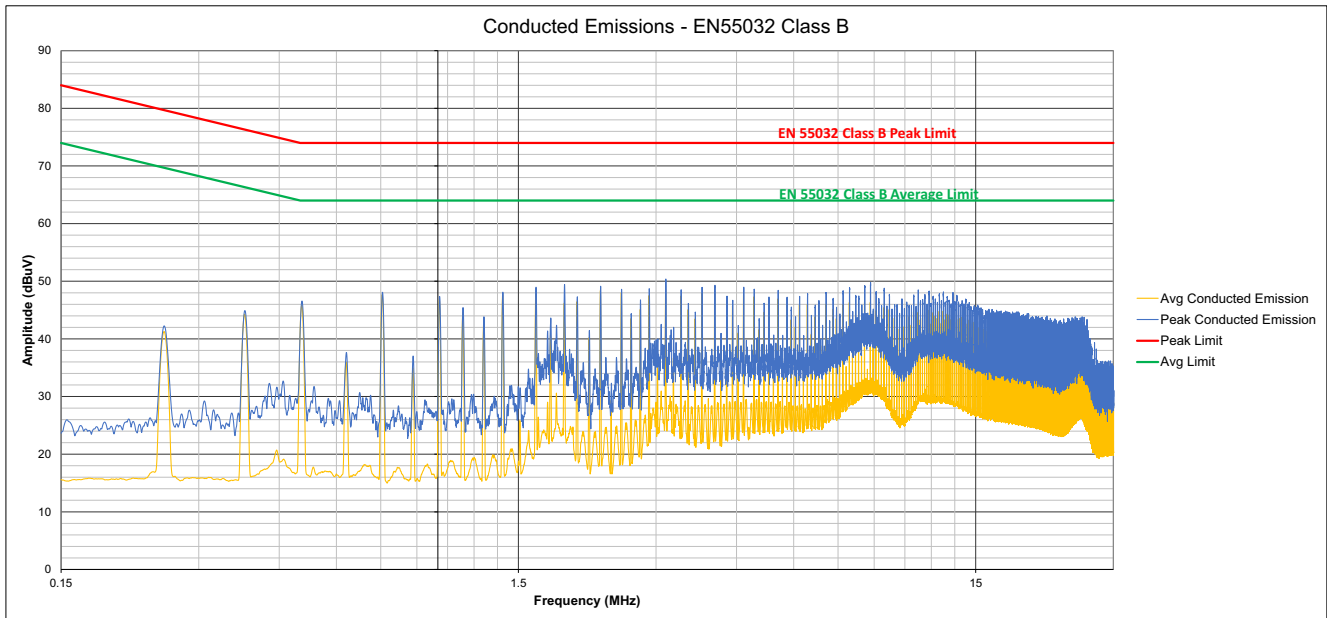

Figure 61. Si3406-ISO-FB EVB Conducted Emissions Measurements Results; 50 V Input, 12 V Output, 6.5 W Input Power

5.17. Bill of Materials

Table 19 is the BOM listing for the standard 12 V output evaluation board with Option PoE Class 2.

Table 19. Si3406 Isolated Flyback 12 V Bill of Materials

Qty	Ref	Value	Rating	Voltage	Tol	Type	PCB_Footprint	Mfr Part Number	Mfr
1	C1	0.01uF		100V	±10%	X7R	C0805	C0805X7R101-103K	Venkel
1	C10	0.22uF		16V	±10%	X7R	C0805	C0805X7R160-224KNE	Venkel
1	C12	0.1uF		100V	±10%	X7R	C0805	C0805X7R101-104K	Venkel
1	C13	0.1uF		16V	±10%	X7R	C0805	C0805X7R160-104K	Venkel
1	C14	2.2nF		50V	±10%	C0G	C0805	C0805C0G500-222K	Venkel
1	C15	15nF		50V	±5%	C0G	C0805	C0805C0G500-153J	Venkel
1	C16	1000pF		2000V	±5%	C0G	C1808	C1808C0G202-102JNE	Venkel
1	C17	3300pF		2000V	±10%	X7R	C1808	C1808X7R202-332KNE	Venkel
1	C18	1uF		16V	±10%	X5R	C0603	C0603X5R160-105K	Venkel
1	C19	0.01uF		100V	±10%	X7R	C0603	C0603X7R101-103K	Venkel
1	C2	680pF		100V	±1%	C0G	C0805	C0805C0G101-681FNP	Venkel
1	C3	47uF		16V	±20%	X5R	C1210	C1210X5R160-476MNE	Venkel
1	C4	330uF		16V	±20%	Alum_Elec	C3.5X8MM-RAD	860010374011	Würth Elektronik
1	C6	22nF		25V	±5%	C0G	C0805	C0805C0G250-223J	Venkel
1	C8	12uF		100V	±20%	Alum_Elec	C2.5X6.3MM-RAD	EEUFC2A120	Panasonic
1	C9	1uF		100V	±10%	X7R	C1210	C1210X7R101-105K	Venkel
1	D1	SDT5H100P5	5A	100V		Schottky	POWERDI-5	SDT5H100P5-7	Diodes Inc.
1	D2	RS1B	1.0A	100V		Single	DO-214AC	RS1B	Fairchild
1	D3	GREEN					LED-0805-K-K1A2	XZVG54W-8	SunLED
1	D5	DFLT40A-7	3.49A	40V		Zener	POWERDI-123	DFLT40A-7	Diodes Inc.
8	D7, D8, D9, D10, D11, D12, D13, D14	S1B	1.0A	100V		Single	DO-214AC	S1B	Fairchild
4	FB1, FB2, FB3, FB4	1500 Ohm	1000mA			SMT	L0805	742792097	Würth
2	J1, J2	BND_POST	15A			BANANA	BANANA-JACK	101	ABBATRON HH SMITH
2	JP1, JP2	HEADER 1X2				Header	CONN1X2	TSW-102-07-T-S	Samtec
1	LB1	LABEL-Si3406-EVB-ISO-FB-R4.2-12V				POLYIMIDE, WHITE	PTL-14-717	LABEL-Si3406-EVB-ISO-FB-R4.2-12V	Skyworks
4	MH1, MH2, MH3, MH4	4-40				SCREW	MH-125 MH-125NP	NSS-4-4-01	Richco Plastic Co
1	PCB1	Si3406-EVB-ISO-FB REV 4.0				BARE PCB	N/A	Si3406-EVB-ISO-FB REV 4.0	Skyworks
1	R10	4.3K	1/8W		±1%	ThickFilm	R0805	CR0805-8W-4301F	Venkel

Table 19. Si3406 Isolated Flyback 12 V Bill of Materials (Continued)

Qty	Ref	Value	Rating	Voltage	Tol	Type	PCB_Footprint	Mfr Part Number	Mfr
1	R11	1K	1/10W		±1%	ThickFilm	R0805	CR0805-10W-1001F	Venkel
1	R12	105k	1/8W		±1%	ThickFilm	R0805	RC0805FR-07105KL	Yageo
1	R14	330	1/10W		±1%	ThickFilm	R0805	CR0805-10W-3300F	Venkel
3	R15, R16, R21	0	2A			ThickFilm	R0805	CR0805-10W-000	Venkel
1	R17	75	1/10W		±1%	ThickFilm	R0805	CR0805-10W-75R0F	Venkel
1	R18	160K	1/10W		±1%	ThickFilm	R0805	CR0805-10W-1603F	Venkel
1	R19	24.3k	1/8W		±1%	ThickFilm	R0805	CRCW080524K3FKEA	vishay
1	R2	82K	1/10W		±5%	ThickFilm	R0805	CR0805-10W-823J	Venkel
1	R20	12.1K	1/10W		±1%	ThickFilm	R0805	CR0805-10W-1212F	Venkel
1	R22	3K	1/4W		±1%	ThickFilm	R1206	ERJ-8ENF3001V	Panasonic
1	R3	1.6K	1/8W		±1%	ThickFilm	R0805	CR0805-8W-1601F	Venkel
1	R4	24	1/8W		±1%	ThickFilm	R0805	CR0805-8W-24R0F	Venkel
1	R5	1.2	1/10W		±5%	ThickFilm	R0805	CR0805-10W-1R2J	Venkel
1	R7	10	1/10W		±1%	ThickFilm	R0805	CR0805-10W-10R0F	Venkel
1	R8	3	1/8W		±1%	ThickFilm	R0805	CR0805-8W-3R00FT	Venkel
4	SO1, SO2, SO3, SO4	STANDOFF				STANDOFF		2397	SPC Technology
1	T1	750319936		12V		FLYBACK	XFMR-EP10	750319936	Würth Elektronik
3	TP1, TP12, TP17	RED				LOOP	TESTPOINT	5000	Keystone
6	TP8, TP9, TP10, TP13, TP14, TP15	BLACK				LOOP	TESTPOINT	5001	Keystone
1	U2	RJ-45				Receptacle	RJ45-74982104400	74982104400	Würth Elektronik
1	U3	Si3406		120V		PD	QFN20N5X5P0.8	Si3406-A-GM	Skyworks
1	U4	VO618A-3X017T					SO4N10.16P2.54-AKEC	VO618A-3X017T	Vishay
1	U5	TLV431ASN1T1G		16V		SHUNT	TLV431-DBZ	TLV431ASN1T1G	ON Semi
Not Installed Components									
1	C11	0.22uF		16V	±10%	X7R	C0805	C0805X7R160-224KNE	Venkel
8	C20, C21, C22, C23, C24, C25, C26, C27	1nF		100V	±10%	X7R	C0603	C0603X7R101-102K	Venkel
4	C28, C29, C30, C31	1nF		2000V	±5%	X7R	C1206	C1206C102JGRACU	Kemet
1	C5	100uF		6.3V	±10%	X5R	C1210	C1210X5R6R3-107K	Venkel
1	C7	1uF		100V	±10%	X7R	C1210	C1210X7R101-105K	Venkel
2	D15, D16	SMAJ58CA	400W	58V		TVS	DO-214AC	SMAJ58CA	Littelfuse
1	L5	1uH	2.4A		±20%	Shielded	L0805	TFM201208ALD-1R0MTCA	TDK
1	Q1	NVTF56H888NLTAG	14A	80V		N-CHNL	POWER33	NVTF56H888NLTAG	ON Semiconductor
1	R1	1K	1/10W		±1%	ThickFilm	R0805	CR0805-10W-1001F	Venkel
1	R13	0	2A			ThickFilm	R0805	CR0805-10W-000	Venkel

Table 19. Si3406 Isolated Flyback 12 V Bill of Materials (Continued)

Qty	Ref	Value	Rating	Voltage	Tol	Type	PCB_Footprint	Mfr Part Number	Mfr
1	R6	10	1/10W		±1%	ThickFilm	R0805	CR0805-10W-10R0F	Venkel
1	R9	24K	1/10W		±1%	ThickFilm	R0805	CR0805-10W-2402FT	Venkel
1	T2	1200uH	none	1500V	none		XFMR-PA0184NL	PA0184NL	Pulse Engineering
7	TP2, TP3, TP4, TP5, TP6, TP11, TP16	BLACK				LOOP	TESTPOINT	5001	Keystone

6. Tunable Switching Frequency

The switching frequency of the oscillator is selected by choosing an external resistor (R_{FREQ}) connected between R_{FREQ} and V_{POS} pins. The following figure will aid in choosing the R_{FREQ} value to achieve the desired switching frequency.

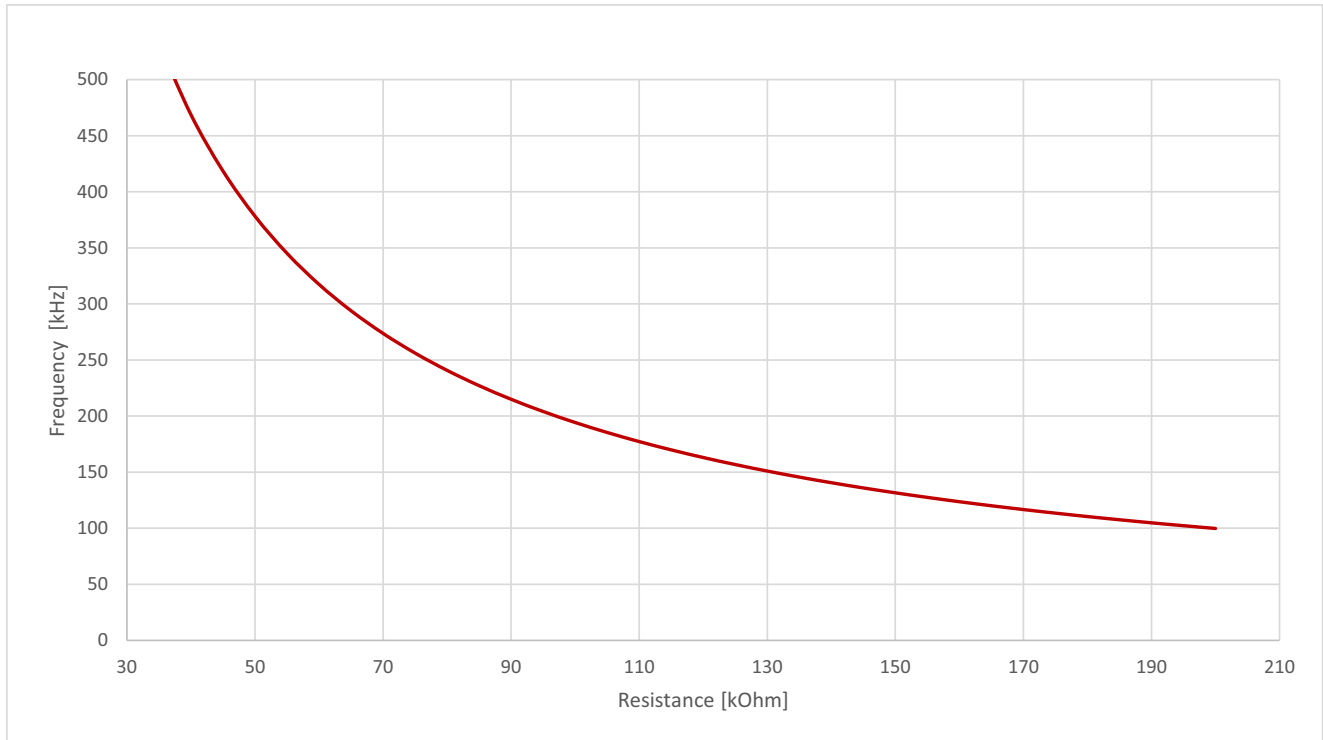

Figure 62. Switching Frequency vs RFREQ

The selected switching frequencies for these applications are 177 kHz, 150 kHz and 123 kHz for 3.3V, 5V and 12V respectively which is achieved by setting the R_{FREQ} resistor (R18) to 110 k Ω , 130 k Ω and 160 k Ω .

7. Board Layout

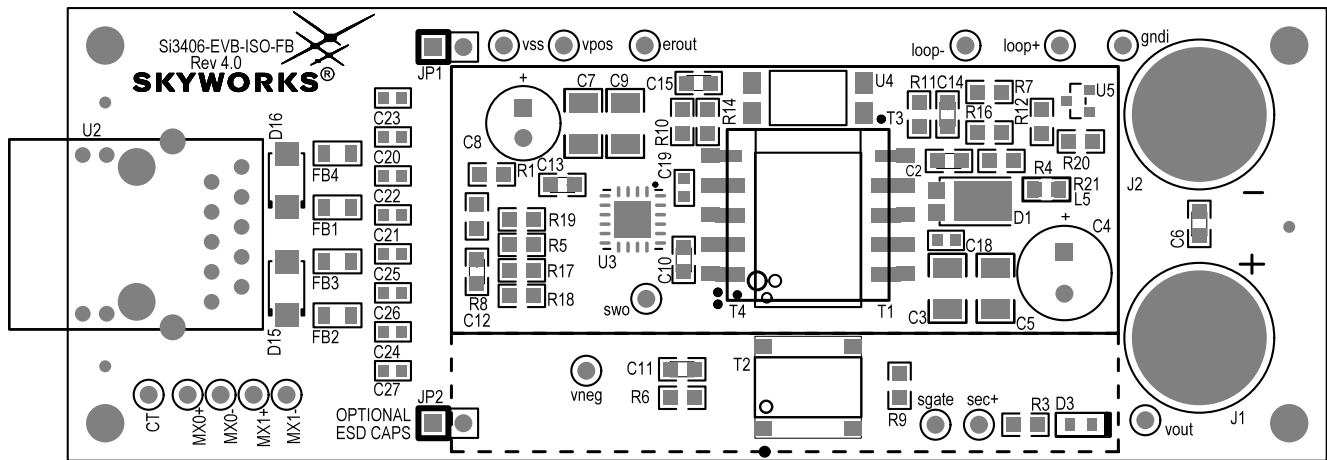

Figure 63. Top Silkscreen

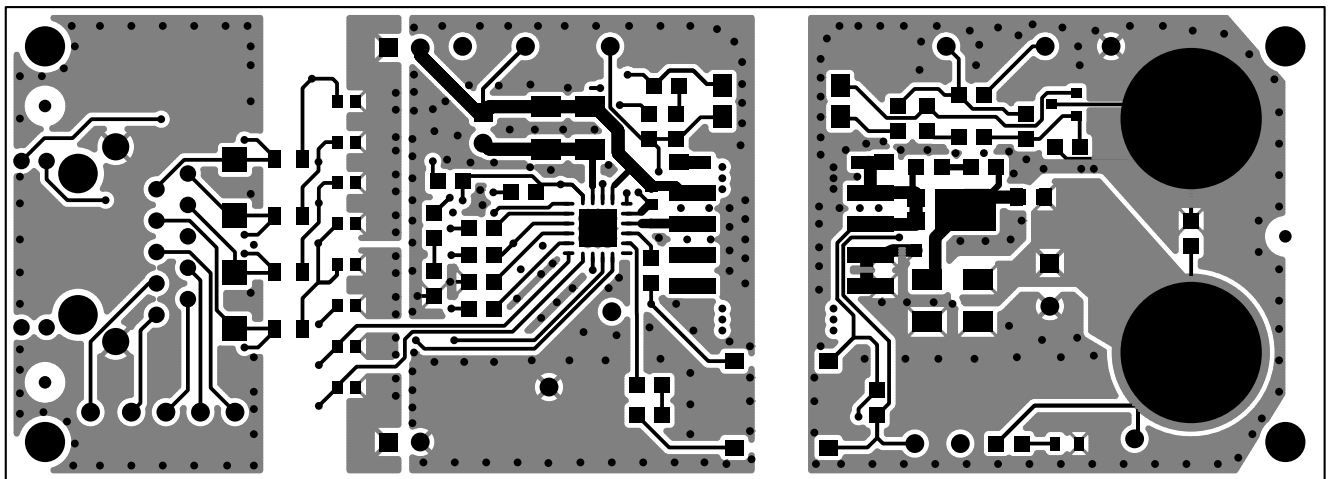

Figure 64. Top Layer

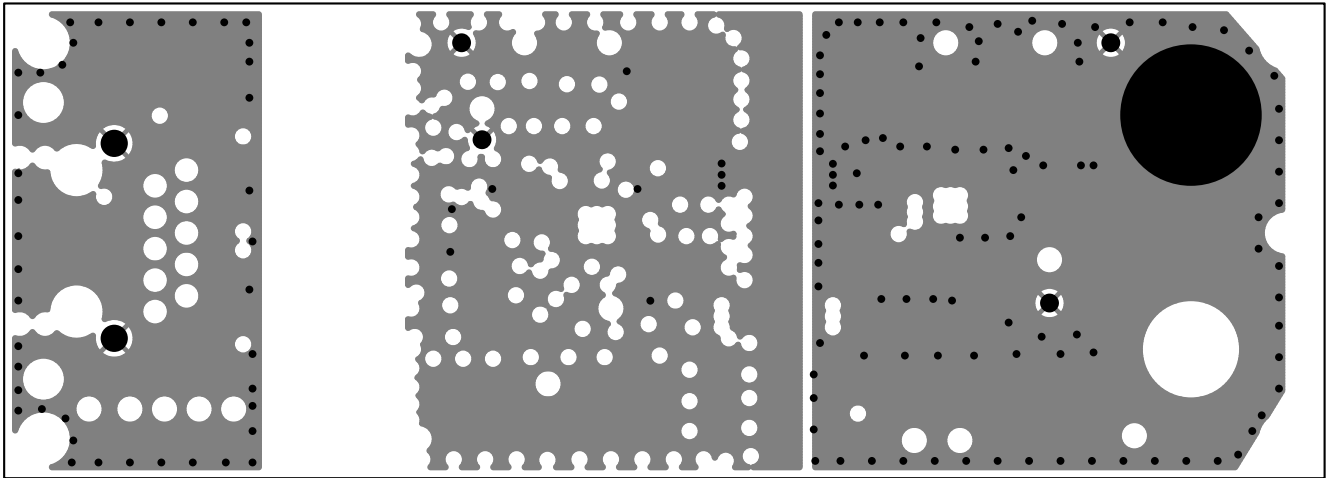

Figure 65. Internal 1 (Layer 2)

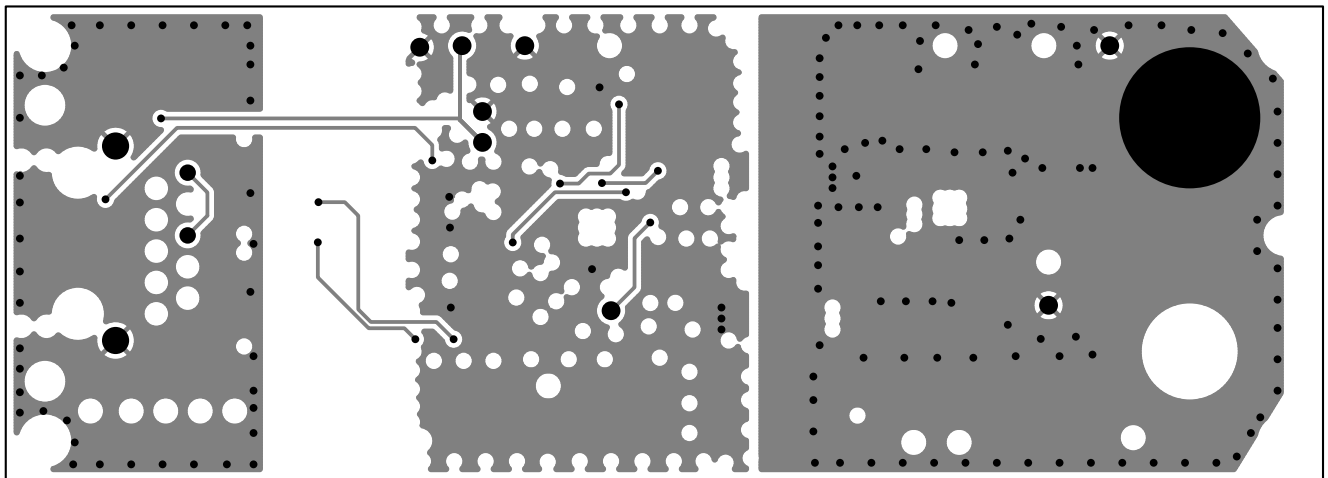

Figure 66. Internal 2 (Layer 3)

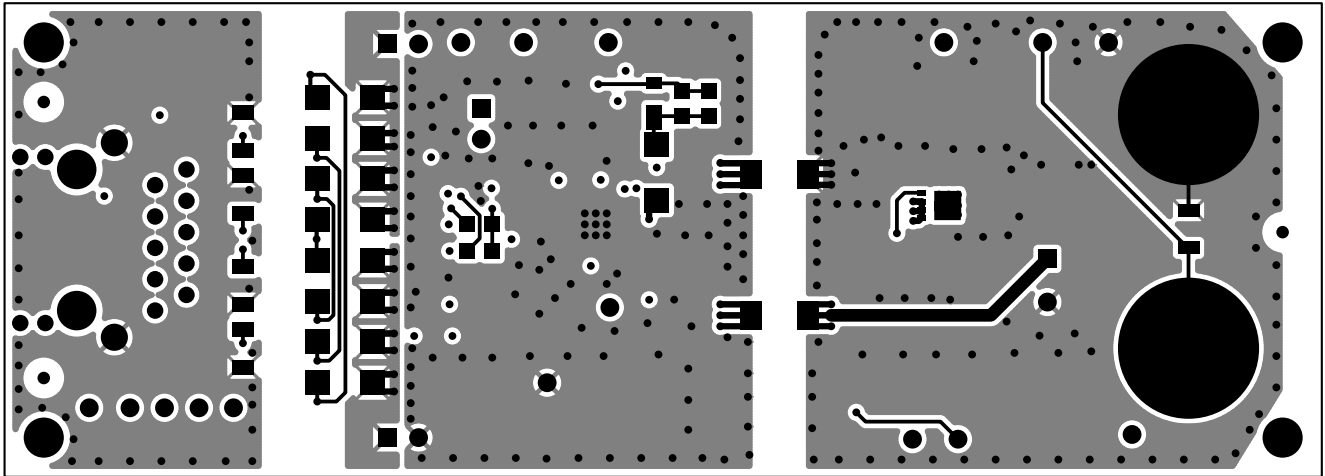

Figure 67. Bottom Layer

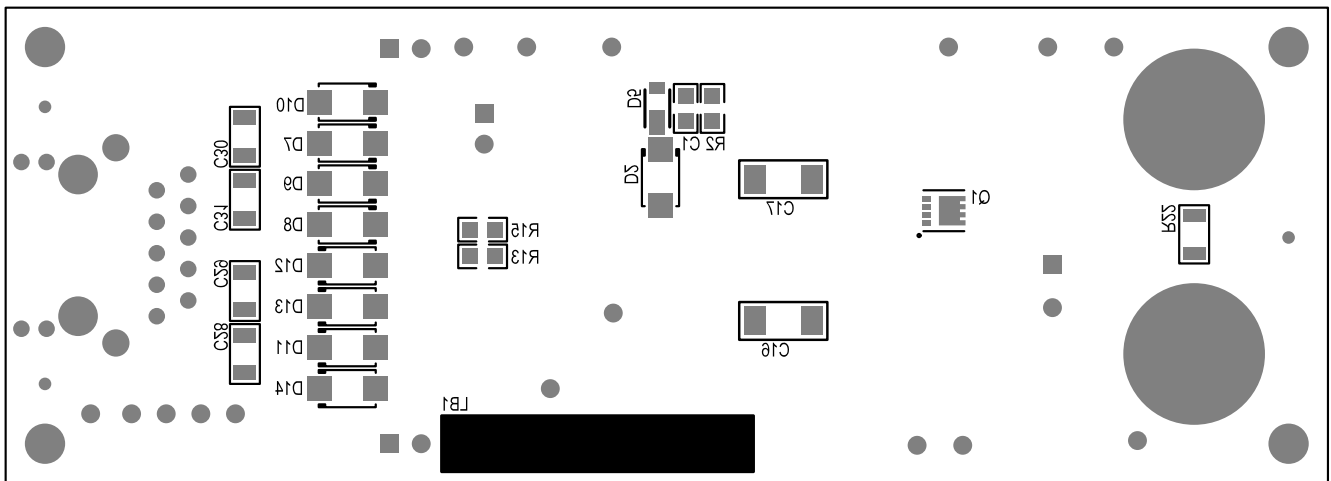

Figure 68. Bottom Silkscreen

8. Design and Layout Checklist

The complete EVB design databases for the four configurations are located at:

<https://www.skyworksinc.com/Products/Power-Powered-Devices>.

Skyworks strongly recommends using these EVB schematics and layout files as a starting point to ensure robust performance and avoid common mistakes in the schematic capture and PCB layout processes.

Below is a recommended design checklist that can assist in trouble-free development of robust PD designs.

Refer also to the [Si3406s Data Sheet](#) and “[AN1130: Si3404/06x PoE-PD Controller Design Guide](#)” when using the following checklist.

1. Design Planning Checklist:
 - a. Determine if your design requires an isolated or non-isolated topology. For more information, see AN1130.
 - b. Skyworks strongly recommends using the EVB schematics and layout files as a starting point as you begin integrating the Si3406-ISO-FB into your system design process.
 - c. Determine your load's power requirements (i.e., VOUT and IOU consumed by the PD, including the typical expected transient surge conditions). In general, to achieve the highest overall efficiency performance of the Si3406-ISO-FB, choose the highest output voltage option used in your PD and then post regulate to the lower supply rails, if necessary.
 - d. Based on your required PD power level, select the appropriate class resistor RCLASS value by referring to AN1130
2. General Design Checklist:
 - a. Non-standard PoE injectors turns on the PD without detection and classification phases. In most cases, dV/dt is not controlled and could violate IEEE requirements. To ensure robustness with those injectors, please include a $3\ \Omega$ resistors in series with the 100 nF / 100 V detection capacitor.
 - b. If MPS is not used, Skyworks recommends the inclusion of a minimum load (250 mW) to avoid the PSE port being disconnected by the PSE. If your load is not at least 250 mW, add a resistor load to dissipate at least 250 mW.
3. Layout Guidelines:
 - a. Make sure VNEG pin of the Si3406 is connected to the backside of the QFN package with an adequate thermal plane, as noted in the data sheet and AN1130
 - b. Keep the trace length from SWO to VSS as short as possible. Make all of the power (high current) traces as short, direct, and thick as possible. It is a good practice on a standard PCB board to make the traces an absolute minimum of 15 mils (0.381 mm) per ampere.
 - c. Usually, one standard via handles 200 mA of current. If the trace needs to conduct a significant amount of current from one plane to the other, use multiple vias.
 - d. Keep the circular area of the loop from SWO to the transformer and returning from the input filter capacitors (C8, C9, C19) to VSS as small a diameter as possible. Also, minimize the circular area of the loop from the output of the transformer to the rectifier diode (D1) and returning through the output filter capacitor back to the transformer as small as possible. If possible, keep the direction of current flow in these two loops the same.
 - e. Keep the high-power traces as short as possible.
 - f. Keep the feedback and loop stability components as far from the transformer and noisy power traces as possible.
 - g. If the outputs have a ground plane or positive output plane, do not connect the high current carrying components and the filter capacitors through the plane. Connect them together, and then connect to the plane at a single point.

To help ensure first-pass success, contact our customer support by submitting a help ticket and uploading your schematics and layout files for review.

9. Complete 3.3 V Si3406 Isolated Flyback Sifos Compatibility Test Reports

Table 20. Si3406-ISO-FB-3.3 V Alt A MDI Test Report

Detection and Classification	PSE Emulation		Pairs	A	Polarity	MDI	Det_Cycles	3
Parameter Cycle	1	Units	Min.	Max.	Average	Low Limit	High Limit P/F	
Rdet	24.44	kohm	24.44	24.44	24.44	23.70	26.30	P
Rdet_final	24.44	kohm	24.44	24.44	24.44	23.70	26.30	P
Rdet_unpwr	>99.00	kohm	99.00	99.00	99.00	<12.00	>45.00	P
Rdet_at_Vmin	24.56	kohm	24.56	24.56	24.56	23.70	26.30	P
Rdet_at_Vmax	24.40	kohm	24.40	24.40	24.40	23.70	26.30	P
Rdet_Voffset	1.4	VDC	1.4	1.4	1.4	0.0	1.9	P
Cdet	0.10	uF	0.10	0.10	0.10	0.05	0.12	P
Cdet_final	0.10	uF	0.10	0.10	0.10	0.05	0.12	P
1 Event Classification								
Iclass	18.6	mA	18.6	18.6	18.6	17.0	20.0	P
ClassNum	2		2	2	-	0	4	P
Tclass	0.0005	sec	0.0005	0.0005	0.0005	0.0005	0.0050	P
ClassStability	1					1	1	P
Iclass_at_Vmin	18.4	mA	18.4	18.4	18.4	17.0	20.0	P
Iclass_at_Vmax	18.3	mA	18.3	18.3	18.3	17.0	20.0	P
2 Event Classification								
Iclass_event1	18.6	mA	18.6	18.6	18.6	17.0	20.0	P
Iclass_event2	18.6	mA	18.6	18.6	18.6	17.0	20.0	P
MarkI	1.49	mA	1.49	1.49	1.49	0.25	4.00	INFO
ClassNum2	2		2	2	-	0	4	P
Tclass_event1	0.0005	sec	0.0005	0.0005	0.0005	0.0005	0.0050	P
Tclass_event2	0.0005	sec	0.0005	0.0005	0.0005	0.0005	0.0050	P
ClassStability_event1	1					1	1	P
ClassStability_event2	1					1	1	P

Table 20. Si3406-ISO-FB-3.3 V Alt A MDI Test Report (Continued)

Power-Up / Down								
Parameter Cycle	1	Units	Min.	Max.	Average	Low Limit	High Limit P/F	
InrushI_1	155.6	mA	155.6	155.6	155.6	0.0	400.0	P
InrushI_2	155.4	mA	155.4	155.4	155.4	0.0	400.0	P
Pmax_Tdelay	0.2	W	0.2	0.2	0.2	0.0	8.4	P
Inrush_delayed	0		0	0	-	0	0	P
Von	37.6	VDC	37.6	37.6	37.6	30.0	42.0	P
Voff	33.6	VDC	33.6	33.6	33.6	30.0	42.0	P
Vhyst	4.0	VDC	4.0	4.0	4.0	2.8	12.0	INFO
BackfeedV	0.1	VDC	0.1	0.1	0.1	0.0	2.8	P
ClassRecover	0		0	0	-	0	0	P
SigRecoverTime	0.0	sec	0.0	0.0	0.0	0.0	30.0	P
MDI Powered Type-1	PSE Emulation		On Time	10 sec	Off Time	10 sec	Vport	38.0
Parameter Cycle	1	Units	Min.	Max.	Average	Low Lim.	High Lim.	P/F
MinI_1	8.3	mA	8.3	8.3	8.3	0.0	219.5	P
MaxI_1	13.5	mA	13.5	13.5	13.5	10.0	219.5	P
Vport_1	38.0	VDC	38.0	38.0	38.0	37.0	57.0	INFO
Ppeak_1	0.51	W	0.51	0.51	0.51	0.0	8.4	P
Pavg_1	0.40	W	0.40	0.40	0.40	0.0	6.5	P
MPSViolation_1	0		0	0	-	0	0	P
TcutWindowViolation_1	0		0	0	-	0	0	P
DutyCycleViolation_1	0		0	0	-	0	0	P
MDI Powered Type-2 PHY	PSE Emulation		On Time	10 sec	Off Time	10 sec	Vport	43.5
Parameter Cycle	1	Units	Min.	Max.	Average	Low Lim.	High Lim.	P/F
MinI_2	2.7	mA	2.7	2.7	2.7	0.0	191.8	P
MaxI_2	50.5	mA	50.5	50.5	50.5	10.0	191.8	P
Vport_2	43.6	VDC	43.6	43.6	43.6	42.5	57.0	INFO
Ppeak_2	2.20	W	2.20	2.20	2.20	0.0	8.4	P
Pavg_2	0.46	W	0.46	0.46	0.46	0.0	6.5	P
MPSViolation_2	0		0	0	-	0	0	P
TcutWindowViolation_2	0		0	0	-	0	0	P
DutyCycleViolation_2	0		0	0	-	0	0	P
MDI Powered Type-2 LLDP	PSE Emulation		On Time	-1 sec	Off Time	10 sec	Vport	-1.0
Parameter Cycle	1	Units	Min.	Max.	Average	Low Lim.	High Lim.	P/F

Table 21. Si3406-ISO-FB-3.3 V Alt A MDI-X Test Report

Detection and Classification	PSE Emulation		Pairs	A	Polarity	MDI-X	Det_Cycles	3
Parameter Cycle	1	Units	Min.	Max.	Average	Low Lim.	High Lim.	P/F
Rdet	24.44	kohm	24.44	24.44	24.44	23.70	26.30	P
Rdet_final	24.49	kohm	24.49	24.49	24.49	23.70	26.30	P
Rdet_unpwr	>99.00	kohm	99.00	99.00	99.00	<12.00	>45.00	P
Rdet_at_Vmin	24.88	kohm	24.88	24.88	24.88	23.70	26.30	P
Rdet_at_Vmax	24.52	kohm	24.52	24.52	24.52	23.70	26.30	P
Rdet_Voffset	1.4	VDC	1.4	1.4	1.4	0.0	1.9	P
Cdet	0.10	uF	0.10	0.10	0.10	0.05	0.12	P
Cdet_final	0.10	uF	0.10	0.10	0.10	0.05	0.12	P
1 Event Classification								
Iclass	18.6	mA	18.6	18.6	18.6	17.0	20.0	P
ClassNum	2		2	2	-	0	4	P
Tclass	0.0005	sec	0.0005	0.0005	0.0005	0.0005	0.0050	P
ClassStability	1					1	1	P
Iclass_at_Vmin	18.4	mA	18.4	18.4	18.4	17.0	20.0	P
Iclass_at_Vmax	18.4	mA	18.4	18.4	18.4	17.0	20.0	P
2 Event Classification								
Iclass_event1	18.6	mA	18.6	18.6	18.6	17.0	20.0	P
Iclass_event2	18.6	mA	18.6	18.6	18.6	17.0	20.0	P
MarkI	1.49	mA	1.49	1.49	1.49	0.25	4.00	INFO
ClassNum2	2		2	2	-	0	4	P
Tclass_event1	0.0005	sec	0.0005	0.0005	0.0005	0.0005	0.0050	P
Tclass_event2	0.0005	sec	0.0005	0.0005	0.0005	0.0005	0.0050	P
ClassStability_event1	1					1	1	P
ClassStability_event2	1					1	1	P

Table 21. Si3406-ISO-FB-3.3 V Alt A MDI-X Test Report (Continued)

Power-Up / Down								
Parameter Cycle	1	Units	Min.	Max.	Average	Low Lim.	High Lim.	P/F
InrushI_1	155.8	mA	155.8	155.8	155.8	0.0	400.0	P
InrushI_2	155.3	mA	155.3	155.3	155.3	0.0	400.0	P
Pmax_Tdelay	0.2	W	0.2	0.2	0.2	0.0	8.4	P
Inrush_delayed	0		0	0	-	0	0	P
Von	37.8	VDC	37.8	37.8	37.8	30.0	42.0	P
Voff	33.7	VDC	33.7	33.7	33.7	30.0	42.0	P
Vhyst	4.0	VDC	4.0	4.0	4.0	2.8	12.0	INFO
BackfeedV	0.0	VDC	0.0	0.0	0.0	0.0	2.8	P
ClassRecover	0		0	0	-	0	0	P
SigRecoverTime	0.0	sec	0.0	0.0	0.0	0.0	30.0	P
MDI Powered Type-1	PSE Emulation		On Time	10 sec	Off Time	10 sec	Vport	38.0
Parameter Cycle	1	Units	Min.	Max.	Average	Low Lim.	High Lim.	P/F
MinI_1	8.2	mA	8.2	8.2	8.2	0.0	218.8	P
MaxI_1	13.5	mA	13.5	13.5	13.5	10.0	218.8	P
Vport_1	38.2	VDC	38.2	38.2	38.2	37.0	57.0	INFO
Ppeak_1	0.52	W	0.52	0.52	0.52	0.0	8.4	P
Pavg_1	0.40	W	0.40	0.40	0.40	0.0	6.5	P
MPSViolation_1	0		0	0	-	0	0	P
TcutWindowViolation_1	0		0	0	-	0	0	P
DutyCycleViolation_1	0		0	0	-	0	0	P
MDI Powered Type-2 PHY	PSE Emulation		On Time	10 sec	Off Time	10 sec	Vport	43.5
Parameter Cycle	1	Units	Min.	Max.	Average	Low Lim.	High Lim.	P/F
MinI_2	2.7	mA	2.7	2.7	2.7	0.0	191.3	P
MaxI_2	45.7	mA	45.7	45.7	45.7	10.0	191.3	P
Vport_2	43.8	VDC	43.8	43.8	43.8	42.5	57.0	INFO
Ppeak_2	2.00	W	2.00	2.00	2.00	0.0	8.4	P
Pavg_2	0.45	W	0.45	0.45	0.45	0.0	6.5	P
MPSViolation_2	0		0	0	-	0	0	P
TcutWindowViolation_2	0		0	0	-	0	0	P
DutyCycleViolation_2	0		0	0	-	0	0	P
MDI Powered Type-2 LLDP	PSE Emulation		On Time	-1 sec	Off Time	10 sec	Vport	-1.0
Parameter Cycle	1	Units	Min.	Max.	Average	Low Lim.	High Lim.	P/F

Table 22. Si3406-ISO-FB-3.3 V Alt B MDI Test Report

Detection and Classification	PSE Emulation		Pairs	B	Polarity	MDI	Det_Cycles	3
Parameter Cycle	1	Units	Min.	Max.	Average	Low Lim.	High Lim.	P/F
Rdet	24.44	kohm	24.44	24.44	24.44	23.70	26.30	P
Rdet_final	24.46	kohm	24.46	24.46	24.46	23.70	26.30	P
Rdet_unpwr	>99.00	kohm	99.00	99.00	99.00	<12.00	>45.00	P
Rdet_at_Vmin	24.65	kohm	24.65	24.65	24.65	23.70	26.30	P
Rdet_at_Vmax	24.60	kohm	24.60	24.60	24.60	23.70	26.30	P
Rdet_Voffset	1.4	VDC	1.4	1.4	1.4	0.0	1.9	P
Cdet	0.10	uF	0.10	0.10	0.10	0.05	0.12	P
Cdet_final	0.10	uF	0.10	0.10	0.10	0.05	0.12	P
1 Event Classification								
Iclass	18.7	mA	18.7	18.7	18.7	17.0	20.0	P
ClassNum	2		2	2	-	0	4	P
Tclass	0.0005	sec	0.0005	0.0005	0.0005	0.0005	0.0050	P
ClassStability	1					1	1	P
Iclass_at_Vmin	18.8	mA	18.8	18.8	18.8	17.0	20.0	P
Iclass_at_Vmax	18.6	mA	18.6	18.6	18.6	17.0	20.0	P
2 Event Classification								
Iclass_event1	18.7	mA	18.7	18.7	18.7	17.0	20.0	P
Iclass_event2	18.7	mA	18.7	18.7	18.7	17.0	20.0	P
MarkI	1.57	mA	1.57	1.57	1.57	0.25	4.00	INFO
ClassNum2	2		2	2	-	0	4	P
Tclass_event1	0.0005	sec	0.0005	0.0005	0.0005	0.0005	0.0050	P
Tclass_event2	0.0005	sec	0.0005	0.0005	0.0005	0.0005	0.0050	P
ClassStability_event1	1					1	1	P
ClassStability_event2	1					1	1	P

Table 22. Si3406-ISO-FB-3.3 V Alt B MDI Test Report (Continued)

Power-Up / Down								
Parameter Cycle	1	Units	Min.	Max.	Average	Low Lim.	High Lim.	P/F
InrushI_1	156.1	mA	156.1	156.1	156.1	0.0	400.0	P
InrushI_2	156.1	mA	156.1	156.1	156.1	0.0	400.0	P
Pmax_Tdelay	0.2	W	0.2	0.2	0.2	0.0	8.4	P
Inrush_delayed	0		0	0	-	0	0	P
Von	37.6	VDC	37.6	37.6	37.6	30.0	42.0	P
Voff	33.6	VDC	33.6	33.6	33.6	30.0	42.0	P
Vhyst	4.0	VDC	4.0	4.0	4.0	2.8	12.0	INFO
BackfeedV	0.1	VDC	0.1	0.1	0.1	0.0	2.8	P
ClassRecover	0		0	0	-	0	0	P
SigRecoverTime	0.0	sec	0.0	0.0	0.0	0.0	30.0	P
MDI Powered Type-1	PSE Emulation		On Time	10 sec	Off Time	10 sec	Vport	38.0
Parameter Cycle	1	Units	Min.	Max.	Average	Low Lim.	High Lim.	P/F
MinI_1	7.9	mA	7.9	7.9	7.9	0.0	219.8	P
MaxI_1	13.1	mA	13.1	13.1	13.1	10.0	219.8	P
Vport_1	38.0	VDC	38.0	38.0	38.0	37.0	57.0	INFO
Ppeak_1	0.50	W	0.50	0.50	0.50	0.0	8.4	P
Pavg_1	0.38	W	0.38	0.38	0.38	0.0	6.5	P
MPSViolation_1	0		0	0	-	0	0	P
TcutWindowViolation_1	0		0	0	-	0	0	P
DutyCycleViolation_1	0		0	0	-	0	0	P
MDI Powered Type-2 PHY	PSE Emulation		On Time	10 sec	Off Time	10 sec	Vport	43.5
Parameter Cycle	1	Units	Min.	Max.	Average	Low Lim.	High Lim.	P/F
MinI_2	2.5	mA	2.5	2.5	2.5	0.0	191.8	P
MaxI_2	33.7	mA	33.7	33.7	33.7	10.0	191.8	P
Vport_2	43.6	VDC	43.6	43.6	43.6	42.5	57.0	INFO
Ppeak_2	1.47	W	1.47	1.47	1.47	0.0	8.4	P
Pavg_2	0.44	W	0.44	0.44	0.44	0.0	6.5	P
MPSViolation_2	0		0	0	-	0	0	P
TcutWindowViolation_2	0		0	0	-	0	0	P
DutyCycleViolation_2	0		0	0	-	0	0	P
MDI Powered Type-2 LLDP	PSE Emulation		On Time	-1 sec	Off Time	10 sec	Vport	-1.0
Parameter Cycle	1	Units	Min.	Max.	Average	Low Lim.	High Lim.	P/F

Table 23. Si3406-ISO-FB-3.3 V Alt B MDI-X Test Report

Detection and Classification	PSE Emulation		Pairs	B	Polarity	MDI-X	Det_Cycles	3
Parameter Cycle	1	Units	Min.	Max.	Average	Low Lim.	High Lim.	P/F
Rdet	24.51	kohm	24.51	24.51	24.51	23.70	26.30	P
Rdet_final	24.44	kohm	24.44	24.44	24.44	23.70	26.30	P
Rdet_unpwr	>99.00	kohm	99.00	99.00	99.00	<12.00	>45.00	P
Rdet_at_Vmin	24.75	kohm	24.75	24.75	24.75	23.70	26.30	P
Rdet_at_Vmax	24.57	kohm	24.57	24.57	24.57	23.70	26.30	P
Rdet_Voffset	1.4	VDC	1.4	1.4	1.4	0.0	1.9	P
Cdet	0.10	uF	0.10	0.10	0.10	0.05	0.12	P
Cdet_final	0.10	uF	0.10	0.10	0.10	0.05	0.12	P
1 Event Classification								
Iclass	18.7	mA	18.7	18.7	18.7	17.0	20.0	P
ClassNum	2		2	2	-	0	4	P
Tclass	0.0005	sec	0.0005	0.0005	0.0005	0.0005	0.0050	P
ClassStability	1					1	1	P
Iclass_at_Vmin	18.6	mA	18.6	18.6	18.6	17.0	20.0	P
Iclass_at_Vmax	18.6	mA	18.6	18.6	18.6	17.0	20.0	P
2 Event Classification								
Iclass_event1	18.7	mA	18.7	18.7	18.7	17.0	20.0	P
Iclass_event2	18.7	mA	18.7	18.7	18.7	17.0	20.0	P
MarkI	1.57	mA	1.57	1.57	1.57	0.25	4.00	INFO
ClassNum2	2		2	2	-	0	4	P
Tclass_event1	0.0005	sec	0.0005	0.0005	0.0005	0.0005	0.0050	P
Tclass_event2	0.0005	sec	0.0005	0.0005	0.0005	0.0005	0.0050	P
ClassStability_event1	1					1	1	P
ClassStability_event2	1					1	1	P

Table 23. Si3406-ISO-FB-3.3 V Alt B MDI-X Test Report (Continued)

Power-Up / Down								
Parameter Cycle	1	Units	Min.	Max.	Average	Low Lim.	High Lim.	P/F
InrushI_1	156.1	mA	156.1	156.1	156.1	0.0	400.0	P
InrushI_2	155.8	mA	155.8	155.8	155.8	0.0	400.0	P
Pmax_Tdelay	0.2	W	0.2	0.2	0.2	0.0	8.4	P
Inrush_delayed	0		0	0	-	0	0	P
Von	37.7	VDC	37.7	37.7	37.7	30.0	42.0	P
Voff	33.7	VDC	33.7	33.7	33.7	30.0	42.0	P
Vhyst	4.0	VDC	4.0	4.0	4.0	2.8	12.0	INFO
BackfeedV	0.0	VDC	0.0	0.0	0.0	0.0	2.8	P
ClassRecover	0		0	0	-	0	0	P
SigRecoverTime	0.0	sec	0.0	0.0	0.0	0.0	30.0	P
MDI Powered Type-1	PSE Emulation		On Time	10 sec	Off Time	10 sec	Vport	38.0
Parameter Cycle	1	Units	Min.	Max.	Average	Low Lim.	High Lim.	P/F
MinI_1	7.9	mA	7.9	7.9	7.9	0.0	219.4	P
MaxI_1	13.1	mA	13.1	13.1	13.1	10.0	219.4	P
Vport_1	38.1	VDC	38.1	38.1	38.1	37.0	57.0	INFO
Ppeak_1	0.50	W	0.50	0.50	0.50	0.0	8.4	P
Pavg_1	0.38	W	0.38	0.38	0.38	0.0	6.5	P
MPSViolation_1	0		0	0	-	0	0	P
TcutWindowViolation_1	0		0	0	-	0	0	P
DutyCycleViolation_1	0		0	0	-	0	0	P
MDI Powered Type-2 PHY	PSE Emulation		On Time	10 sec	Off Time	10 sec	Vport	43.5
Parameter Cycle	1	Units	Min.	Max.	Average	Low Lim.	High Lim.	P/F
MinI_2	2.2	mA	2.2	2.2	2.2	0.0	191.4	P
MaxI_2	45.7	mA	45.7	45.7	45.7	10.0	191.4	P
Vport_2	43.7	VDC	43.7	43.7	43.7	42.5	57.0	INFO
Ppeak_2	2.00	W	2.00	2.00	2.00	0.0	8.4	P
Pavg_2	0.44	W	0.44	0.44	0.44	0.0	6.5	P
MPSViolation_2	0		0	0	-	0	0	P
TcutWindowViolation_2	0		0	0	-	0	0	P
DutyCycleViolation_2	0		0	0	-	0	0	P
MDI Powered Type-2 LLDP	PSE Emulation		On Time	-1 sec	Off Time	10 sec	Vport	-1.0
Parameter Cycle	1	Units	Min.	Max.	Average	Low Lim.	High Lim.	P/F

10. Complete 5 V Si3406 Isolated Flyback Sifos Compatibility Test Reports

Table 24. Si3406-ISO-FB-5 V Alt A MDI Test Report

Detection and Classification	PSE Emulation		Pairs	A	Polarity	MDI	Det_Cycles	3
Parameter Cycle	1	Units	Min.	Max.	Average	Low Lim.	High Lim.	P/F
Rdet	24.37	kohm	24.37	24.37	24.37	23.70	26.30	P
Rdet_final	24.40	kohm	24.40	24.40	24.40	23.70	26.30	P
Rdet_unpwr	>99.00	kohm	99.00	99.00	99.00	<12.00	>45.00	P
Rdet_at_Vmin	24.69	kohm	24.69	24.69	24.69	23.70	26.30	P
Rdet_at_Vmax	24.45	kohm	24.45	24.45	24.45	23.70	26.30	P
Rdet_Voffset	1.4	VDC	1.4	1.4	1.4	0.0	1.9	P
Cdet	0.10	uF	0.10	0.10	0.10	0.05	0.12	P
Cdet_final	0.10	uF	0.10	0.10	0.10	0.05	0.12	P
1 Event Classification								
Iclass	18.3	mA	18.3	18.3	18.3	17.0	20.0	P
ClassNum	2		2	2	-	0	4	P
Tclass	0.0005	sec	0.0005	0.0005	0.0005	0.0005	0.0050	P
ClassStability	1					1	1	P
Iclass_at_Vmin	18.5	mA	18.5	18.5	18.5	17.0	20.0	P
Iclass_at_Vmax	18.1	mA	18.1	18.1	18.1	17.0	20.0	P
2 Event Classification								
Iclass_event1	18.3	mA	18.3	18.3	18.3	17.0	20.0	P
Iclass_event2	18.3	mA	18.3	18.3	18.3	17.0	20.0	P
MarkI	1.66	mA	1.66	1.66	1.66	0.25	4.00	INFO
ClassNum2	2		2	2	-	0	4	P
Tclass_event1	0.0005	sec	0.0005	0.0005	0.0005	0.0005	0.0050	P
Tclass_event2	0.0005	sec	0.0005	0.0005	0.0005	0.0005	0.0050	P
ClassStability_event1	1					1	1	P
ClassStability_event2	1					1	1	P

Table 24. Si3406-ISO-FB-5 V Alt A MDI Test Report (Continued)

Power-Up / Down								
Parameter Cycle	1	Units	Min.	Max.	Average	Low Lim.	High Lim.	P/F
InrushI_1	161.5	mA	161.5	161.5	161.5	0.0	400.0	P
InrushI_2	160.9	mA	160.9	160.9	160.9	0.0	400.0	P
Pmax_Tdelay	0.2	W	0.2	0.2	0.2	0.0	8.4	P
Inrush_delayed	0		0	0	-	0	0	P
Von	37.3	VDC	37.3	37.3	37.3	30.0	42.0	P
Voff	33.6	VDC	33.6	33.6	33.6	30.0	42.0	P
Vhyst	3.7	VDC	3.7	3.7	3.7	2.8	12.0	INFO
BackfeedV	0.0	VDC	0.0	0.0	0.0	0.0	2.8	P
ClassRecover	0		0	0	-	0	0	P
SigRecoverTime	0.0	sec	0.0	0.0	0.0	0.0	30.0	P
MDI Powered Type-1	PSE Emulation		On Time	10 sec	Off Time	10 sec	Vport	38.0
Parameter Cycle	1	Units	Min.	Max.	Average	Low Lim.	High Lim.	P/F
MinI_1	9.1	mA	9.1	9.1	9.1	0.0	219.7	P
MaxI_1	14.3	mA	14.3	14.3	14.3	10.0	219.7	P
Vport_1	38.1	VDC	38.1	38.1	38.1	37.0	57.0	INFO
Ppeak_1	0.55	W	0.55	0.55	0.55	0.0	8.4	P
Pavg_1	0.43	W	0.43	0.43	0.43	0.0	6.5	P
MPSViolation_1	0		0	0	-	0	0	P
TcutWindowViolation_1	0		0	0	-	0	0	P
DutyCycleViolation_1	0		0	0	-	0	0	P
MDI Powered Type-2 PHY	PSE Emulation		On Time	10 sec	Off Time	10 sec	Vport	43.5
Parameter Cycle	1	Units	Min.	Max.	Average	Low Lim.	High Lim.	P/F
MinI_2	3.0	mA	3.0	3.0	3.0	0.0	191.8	P
MaxI_2	51.3	mA	51.3	51.3	51.3	10.0	191.8	P
Vport_2	43.6	VDC	43.6	43.6	43.6	42.5	57.0	INFO
Ppeak_2	2.24	W	2.24	2.24	2.24	0.0	8.4	P
Pavg_2	0.47	W	0.47	0.47	0.47	0.0	6.5	P
MPSViolation_2	0		0	0	-	0	0	P
TcutWindowViolation_2	0		0	0	-	0	0	P
DutyCycleViolation_2	0		0	0	-	0	0	P
MDI Powered Type-2 LLDP	PSE Emulation		On Time	-1 sec	Off Time	10 sec	Vport	-1.0
Parameter Cycle	1	Units	Min.	Max.	Average	Low Lim.	High Lim.	P/F

Table 25. Si3406-ISO-FB-5 V Alt A MDI-X Test Report

Detection and Classification	PSE Emulation		Pairs	A	Polarity	MDI-X	Det_Cycles	3
Parameter Cycle	1	Units	Min.	Max.	Average	Low Lim.	High Lim.	P/F
Rdet	24.37	kohm	24.37	24.37	24.37	23.70	26.30	P
Rdet_final	24.40	kohm	24.40	24.40	24.40	23.70	26.30	P
Rdet_unpwr	>99.00	kohm	99.00	99.00	99.00	<12.00	>45.00	P
Rdet_at_Vmin	24.84	kohm	24.84	24.84	24.84	23.70	26.30	P
Rdet_at_Vmax	24.49	kohm	24.49	24.49	24.49	23.70	26.30	P
Rdet_Voffset	1.4	VDC	1.4	1.4	1.4	0.0	1.9	P
Cdet	0.10	uF	0.10	0.10	0.10	0.05	0.12	P
Cdet_final	0.10	uF	0.10	0.10	0.10	0.05	0.12	P
1 Event Classification								
Iclass	18.3	mA	18.3	18.3	18.3	17.0	20.0	P
ClassNum	2		2	2	-	0	4	P
Tclass	0.0005	sec	0.0005	0.0005	0.0005	0.0005	0.0050	P
ClassStability	1					1	1	P
Iclass_at_Vmin	18.5	mA	18.5	18.5	18.5	17.0	20.0	P
Iclass_at_Vmax	18.3	mA	18.3	18.3	18.3	17.0	20.0	P
2 Event Classification								
Iclass_event1	18.3	mA	18.3	18.3	18.3	17.0	20.0	P
Iclass_event2	18.3	mA	18.3	18.3	18.3	17.0	20.0	P
MarkI	1.66	mA	1.66	1.66	1.66	0.25	4.00	INFO
ClassNum2	2		2	2	-	0	4	P
Tclass_event1	0.0005	sec	0.0005	0.0005	0.0005	0.0005	0.0050	P
Tclass_event2	0.0005	sec	0.0005	0.0005	0.0005	0.0005	0.0050	P
ClassStability_event1	1					1	1	P
ClassStability_event2	1					1	1	P

Table 25. Si3406-ISO-FB-5 V Alt A MDI-X Test Report (Continued)

Power-Up / Down								
Parameter Cycle	1	Units	Min.	Max.	Average	Low Lim.	High Lim.	P/F
InrushI_1	161.5	mA	161.5	161.5	161.5	0.0	400.0	P
InrushI_2	161.0	mA	161.0	161.0	161.0	0.0	400.0	P
Pmax_Tdelay	0.2	W	0.2	0.2	0.2	0.0	8.4	P
Inrush_delayed	0		0	0	-	0	0	P
Von	37.4	VDC	37.4	37.4	37.4	30.0	42.0	P
Voff	33.7	VDC	33.7	33.7	33.7	30.0	42.0	P
Vhyst	3.7	VDC	3.7	3.7	3.7	2.8	12.0	INFO
BackfeedV	0.1	VDC	0.1	0.1	0.1	0.0	2.8	P
ClassRecover	0		0	0	-	0	0	P
SigRecoverTime	0.0	sec	0.0	0.0	0.0	0.0	30.0	P
MDI Powered Type-1	PSE Emulation		On Time	10 sec	Off Time	10 sec	Vport	38.0
Parameter Cycle	1	Units	Min.	Max.	Average	Low Lim.	High Lim.	P/F
MinI_1	9.1	mA	9.1	9.1	9.1	0.0	218.8	P
MaxI_1	14.1	mA	14.1	14.1	14.1	10.0	218.8	P
Vport_1	38.2	VDC	38.2	38.2	38.2	37.0	57.0	INFO
Ppeak_1	0.54	W	0.54	0.54	0.54	0.0	8.4	P
Pavg_1	0.43	W	0.43	0.43	0.43	0.0	6.5	P
MPSViolation_1	0		0	0	-	0	0	P
TcutWindowViolation_1	0		0	0	-	0	0	P
DutyCycleViolation_1	0		0	0	-	0	0	P
MDI Powered Type-2 PHY	PSE Emulation		On Time	10 sec	Off Time	10 sec	Vport	43.5
Parameter Cycle	1	Units	Min.	Max.	Average	Low Lim.	High Lim.	P/F
MinI_2	3.0	mA	3.0	3.0	3.0	0.0	191.3	P
MaxI_2	47.7	mA	47.7	47.7	47.7	10.0	191.3	P
Vport_2	43.8	VDC	43.8	43.8	43.8	42.5	57.0	INFO
Ppeak_2	2.09	W	2.09	2.09	2.09	0.0	8.4	P
Pavg_2	0.47	W	0.47	0.47	0.47	0.0	6.5	P
MPSViolation_2	0		0	0	-	0	0	P
TcutWindowViolation_2	0		0	0	-	0	0	P
DutyCycleViolation_2	0		0	0	-	0	0	P
MDI Powered Type-2 LLDP	PSE Emulation		On Time	-1 sec	Off Time	10 sec	Vport	-1.0
Parameter Cycle	1	Units	Min.	Max.	Average	Low Lim.	High Lim.	P/F

Table 26. Si3406-ISO-FB-5 V Alt B MDI Test Report

Detection and Classification	PSE Emulation		Pairs	B	Polarity	MDI	Det_Cycles	3
Parameter Cycle	1	Units	Min.	Max.	Average	Low Lim.	High Lim.	P/F
Rdet	24.40	kohm	24.40	24.40	24.40	23.70	26.30	P
Rdet_final	24.40	kohm	24.40	24.40	24.40	23.70	26.30	P
Rdet_unpwr	>99.00	kohm	99.00	99.00	99.00	<12.00	>45.00	P
Rdet_at_Vmin	24.56	kohm	24.56	24.56	24.56	23.70	26.30	P
Rdet_at_Vmax	24.50	kohm	24.50	24.50	24.50	23.70	26.30	P
Rdet_Voffset	1.4	VDC	1.4	1.4	1.4	0.0	1.9	P
Cdet	0.10	uF	0.10	0.10	0.10	0.05	0.12	P
Cdet_final	0.10	uF	0.10	0.10	0.10	0.05	0.12	P
1 Event Classification								
Iclass	18.4	mA	18.4	18.4	18.4	17.0	20.0	P
ClassNum	2		2	2	-	0	4	P
Tclass	0.0005	sec	0.0005	0.0005	0.0005	0.0005	0.0050	P
ClassStability	1					1	1	P
Iclass_at_Vmin	18.7	mA	18.7	18.7	18.7	17.0	20.0	P
Iclass_at_Vmax	18.2	mA	18.2	18.2	18.2	17.0	20.0	P
2 Event Classification								
Iclass_event1	18.4	mA	18.4	18.4	18.4	17.0	20.0	P
Iclass_event2	18.4	mA	18.4	18.4	18.4	17.0	20.0	P
MarkI	1.73	mA	1.73	1.73	1.73	0.25	4.00	INFO
ClassNum2	2		2	2	-	0	4	P
Tclass_event1	0.0005	sec	0.0005	0.0005	0.0005	0.0005	0.0050	P
Tclass_event2	0.0005	sec	0.0005	0.0005	0.0005	0.0005	0.0050	P
ClassStability_event1	1					1	1	P
ClassStability_event2	1					1	1	P

Table 26. Si3406-ISO-FB-5 V Alt B MDI Test Report (Continued)

Power-Up / Down								
Parameter Cycle	1	Units	Min.	Max.	Average	Low Lim.	High Lim.	P/F
Inrush1_1	161.7	mA	161.7	161.7	161.7	0.0	400.0	P
Inrush1_2	162.1	mA	162.1	162.1	162.1	0.0	400.0	P
Pmax_Tdelay	0.2	W	0.2	0.2	0.2	0.0	8.4	P
Inrush_delayed	0		0	0	-	0	0	P
Von	37.4	VDC	37.4	37.4	37.4	30.0	42.0	P
Voff	33.6	VDC	33.6	33.6	33.6	30.0	42.0	P
Vhyst	3.7	VDC	3.7	3.7	3.7	2.8	12.0	INFO
BackfeedV	0.1	VDC	0.1	0.1	0.1	0.0	2.8	P
ClassRecover	0		0	0	-	0	0	P
SigRecoverTime	0.0	sec	0.0	0.0	0.0	0.0	30.0	P
MDI Powered Type-1	PSE Emulation		On Time	10 sec	Off Time	10 sec	Vport	38.0
Parameter Cycle	1	Units	Min.	Max.	Average	Low Lim.	High Lim.	P/F
MinI_1	8.3	mA	8.3	8.3	8.3	0.0	219.8	P
MaxI_1	13.5	mA	13.5	13.5	13.5	10.0	219.8	P
Vport_1	38.0	VDC	38.0	38.0	38.0	37.0	57.0	INFO
Ppeak_1	0.51	W	0.51	0.51	0.51	0.0	8.4	P
Pavg_1	0.40	W	0.40	0.40	0.40	0.0	6.5	P
MPSViolation_1	0		0	0	-	0	0	P
TcutWindowViolation_1	0		0	0	-	0	0	P
DutyCycleViolation_1	0		0	0	-	0	0	P
MDI Powered Type-2 PHY	PSE Emulation		On Time	10 sec	Off Time	10 sec	Vport	43.5
Parameter Cycle	1	Units	Min.	Max.	Average	Low Lim.	High Lim.	P/F
MinI_2	2.6	mA	2.6	2.6	2.6	0.0	191.7	P
MaxI_2	45.3	mA	45.3	45.3	45.3	10.0	191.7	P
Vport_2	43.6	VDC	43.6	43.6	43.6	42.5	57.0	INFO
Ppeak_2	1.98	W	1.98	1.98	1.98	0.0	8.4	P
Pavg_2	0.43	W	0.43	0.43	0.43	0.0	6.5	P
MPSViolation_2	0		0	0	-	0	0	P
TcutWindowViolation_2	0		0	0	-	0	0	P
DutyCycleViolation_2	0		0	0	-	0	0	P
MDI Powered Type-2 LLDP	PSE Emulation		On Time	-1 sec	Off Time	10 sec	Vport	-1.0
Parameter Cycle	1	Units	Min.	Max.	Average	Low Lim.	High Lim.	P/F

Table 27. Si3406-ISO-FB-5 V Alt B MDI-X Test Report

Detection and Classification	PSE Emulation		Pairs	B	Polarity	MDI-X	Det_Cycles	3
Parameter Cycle	1	Units	Min.	Max.	Average	Low Lim.	High Lim.	P/F
Rdet	24.35	kohm	24.35	24.35	24.35	23.70	26.30	P
Rdet_final	24.40	kohm	24.40	24.40	24.40	23.70	26.30	P
Rdet_unpwr	>99.00	kohm	99.00	99.00	99.00	<12.00	>45.00	P
Rdet_at_Vmin	24.91	kohm	24.91	24.91	24.91	23.70	26.30	P
Rdet_at_Vmax	24.45	kohm	24.45	24.45	24.45	23.70	26.30	P
Rdet_Voffset	1.4	VDC	1.4	1.4	1.4	0.0	1.9	P
Cdet	0.10	uF	0.10	0.10	0.10	0.05	0.12	P
Cdet_final	0.10	uF	0.10	0.10	0.10	0.05	0.12	P
1 Event Classification								
Iclass	18.4	mA	18.4	18.4	18.4	17.0	20.0	P
ClassNum	2		2	2	-	0	4	P
Tclass	0.0005	sec	0.0005	0.0005	0.0005	0.0005	0.0050	P
ClassStability	1					1	1	P
Iclass_at_Vmin	18.5	mA	18.5	18.5	18.5	17.0	20.0	P
Iclass_at_Vmax	18.4	mA	18.4	18.4	18.4	17.0	20.0	P
2 Event Classification								
Iclass_event1	18.4	mA	18.4	18.4	18.4	17.0	20.0	P
Iclass_event2	18.4	mA	18.4	18.4	18.4	17.0	20.0	P
MarkI	1.73	mA	1.73	1.73	1.73	0.25	4.00	INFO
ClassNum2	2		2	2	-	0	4	P
Tclass_event1	0.0005	sec	0.0005	0.0005	0.0005	0.0005	0.0050	P
Tclass_event2	0.0005	sec	0.0005	0.0005	0.0005	0.0005	0.0050	P
ClassStability_event1	1					1	1	P
ClassStability_event2	1					1	1	P

Table 27. Si3406-ISO-FB-5 V Alt B MDI-X Test Report (Continued)

Power-Up / Down								
Parameter Cycle	1	Units	Min.	Max.	Average	Low Lim.	High Lim.	P/F
InrushI_1	161.0	mA	161.0	161.0	161.0	0.0	400.0	P
InrushI_2	161.3	mA	161.3	161.3	161.3	0.0	400.0	P
Pmax_Tdelay	0.2	W	0.2	0.2	0.2	0.0	8.4	P
Inrush_delayed	0		0	0	-	0	0	P
Von	37.5	VDC	37.5	37.5	37.5	30.0	42.0	P
Voff	33.7	VDC	33.7	33.7	33.7	30.0	42.0	P
Vhyst	3.8	VDC	3.8	3.8	3.8	2.8	12.0	INFO
BackfeedV	0.0	VDC	0.0	0.0	0.0	0.0	2.8	P
ClassRecover	0		0	0	-	0	0	P
SigRecoverTime	0.0	sec	0.0	0.0	0.0	0.0	30.0	P
MDI Powered Type-1	PSE Emulation		On Time	10 sec	Off Time	10 sec	Vport	38.0
Parameter Cycle	1	Units	Min.	Max.	Average	Low Lim.	High Lim.	P/F
MinI_1	8.7	mA	8.7	8.7	8.7	0.0	219.4	P
MaxI_1	13.9	mA	13.9	13.9	13.9	10.0	219.4	P
Vport_1	38.1	VDC	38.1	38.1	38.1	37.0	57.0	INFO
Ppeak_1	0.53	W	0.53	0.53	0.53	0.0	8.4	P
Pavg_1	0.42	W	0.42	0.42	0.42	0.0	6.5	P
MPSViolation_1	0		0	0	-	0	0	P
TcutWindowViolation_1	0		0	0	-	0	0	P
DutyCycleViolation_1	0		0	0	-	0	0	P
MDI Powered Type-2 PHY	PSE Emulation		On Time	10 sec	Off Time	10 sec	Vport	43.5
Parameter Cycle	1	Units	Min.	Max.	Average	Low Lim.	High Lim.	P/F
MinI_2	2.7	mA	2.7	2.7	2.7	0.0	191.5	P
MaxI_2	47.8	mA	47.8	47.8	47.8	10.0	191.5	P
Vport_2	43.7	VDC	43.7	43.7	43.7	42.5	57.0	INFO
Ppeak_2	2.09	W	2.09	2.09	2.09	0.0	8.4	P
Pavg_2	0.46	W	0.46	0.46	0.46	0.0	6.5	P
MPSViolation_2	0		0	0	-	0	0	P
TcutWindowViolation_2	0		0	0	-	0	0	P
DutyCycleViolation_2	0		0	0	-	0	0	P
MDI Powered Type-2 LLDP	PSE Emulation		On Time	-1 sec	Off Time	10 sec	Vport	-1.0
Parameter Cycle	1	Units	Min.	Max.	Average	Low Lim.	High Lim.	P/F

11. Complete 12 V Si3406 Isolated Flyback Sifos Compatibility Test Reports

Table 28. Si3406-ISO-FB-12 V Alt A MDI Test Report

Detection and Classification	PSE Emulation		Pairs	A	Polarity	MDI	Det_Cycles	3
Parameter Cycle	1	Units	Min.	Max.	Average	Low Lim.	High Lim.	P/F
Rdet	24.26	kohm	24.26	24.26	24.26	23.70	26.30	P
Rdet_final	24.37	kohm	24.37	24.37	24.37	23.70	26.30	P
Rdet_unpwr	>99.00	kohm	99.00	99.00	99.00	<12.00	>45.00	P
Rdet_at_Vmin	24.69	kohm	24.69	24.69	24.69	23.70	26.30	P
Rdet_at_Vmax	24.44	kohm	24.44	24.44	24.44	23.70	26.30	P
Rdet_Voffset	1.4	VDC	1.4	1.4	1.4	0.0	1.9	P
Cdet	0.11	uF	0.11	0.11	0.11	0.05	0.12	P
Cdet_final	0.11	uF	0.11	0.11	0.11	0.05	0.12	P
1 Event Classification								
Iclass	18.6	mA	18.6	18.6	18.6	17.0	20.0	P
ClassNum	2		2	2	-	0	4	P
Tclass	0.0005	sec	0.0005	0.0005	0.0005	0.0005	0.0050	P
ClassStability	1					1	1	P
Iclass_at_Vmin	18.5	mA	18.5	18.5	18.5	17.0	20.0	P
Iclass_at_Vmax	18.7	mA	18.7	18.7	18.7	17.0	20.0	P
2 Event Classification								
Iclass_event1	18.6	mA	18.6	18.6	18.6	17.0	20.0	P
Iclass_event2	18.6	mA	18.6	18.6	18.6	17.0	20.0	P
MarkI	1.62	mA	1.62	1.62	1.62	0.25	4.00	INFO
ClassNum2	2		2	2	-	0	4	P
Tclass_event1	0.0005	sec	0.0005	0.0005	0.0005	0.0005	0.0050	P
Tclass_event2	0.0005	sec	0.0005	0.0005	0.0005	0.0005	0.0050	P
ClassStability_event1	1					1	1	P
ClassStability_event2	1					1	1	P

Table 28. Si3406-ISO-FB-12 V Alt A MDI Test Report (Continued)

Power-Up / Down								
Parameter Cycle	1	Units	Min.	Max.	Average	Low Lim.	High Lim.	P/F
InrushI_1	158.8	mA	158.8	158.8	158.8	0.0	400.0	P
InrushI_2	159.8	mA	159.8	159.8	159.8	0.0	400.0	P
Pmax_Tdelay	0.2	W	0.2	0.2	0.2	0.0	8.4	P
Inrush_delayed	0		0	0	-	0	0	P
Von	37.3	VDC	37.3	37.3	37.3	30.0	42.0	P
Voff	33.1	VDC	33.1	33.1	33.1	30.0	42.0	P
Vhyst	4.1	VDC	4.1	4.1	4.1	2.8	12.0	INFO
BackfeedV	0.1	VDC	0.1	0.1	0.1	0.0	2.8	P
ClassRecover	0		0	0	-	0	0	P
SigRecoverTime	0.0	sec	0.0	0.0	0.0	0.0	30.0	P
MDI Powered Type-1	PSE Emulation		On Time	10 sec	Off Time	10 sec	Vport	38.0
Parameter Cycle	1	Units	Min.	Max.	Average	Low Lim.	High Lim.	P/F
MinI_1	8.7	mA	8.7	8.7	8.7	0.0	219.7	P
MaxI_1	15.5	mA	15.5	15.5	15.5	10.0	219.7	P
Vport_1	38.0	VDC	38.0	38.0	38.0	37.0	57.0	INFO
Ppeak_1	0.59	W	0.59	0.59	0.59	0.0	8.4	P
Pavg_1	0.41	W	0.41	0.41	0.41	0.0	6.5	P
MPSViolation_1	0		0	0	-	0	0	P
TcutWindowViolation_1	0		0	0	-	0	0	P
DutyCycleViolation_1	0		0	0	-	0	0	P
MDI Powered Type-2 PHY	PSE Emulation		On Time	10 sec	Off Time	10 sec	Vport	43.5
Parameter Cycle	1	Units	Min.	Max.	Average	Low Lim.	High Lim.	P/F
MinI_2	3.0	mA	3.0	3.0	3.0	0.0	191.8	P
MaxI_2	62.6	mA	62.6	62.6	62.6	10.0	191.8	P
Vport_2	43.6	VDC	43.6	43.6	43.6	42.5	57.0	INFO
Ppeak_2	2.73	W	2.73	2.73	2.73	0.0	8.4	P
Pavg_2	0.49	W	0.49	0.49	0.49	0.0	6.5	P
MPSViolation_2	0		0	0	-	0	0	P
TcutWindowViolation_2	0		0	0	-	0	0	P
DutyCycleViolation_2	0		0	0	-	0	0	P
MDI Powered Type-2 LLDP	PSE Emulation		On Time	-1 sec	Off Time	10 sec	Vport	-1.0
Parameter Cycle	1	Units	Min.	Max.	Average	Low Lim.	High Lim.	P/F

Table 29. Si3406-ISO-FB-12 V Alt A MDI-X Test Report

Detection and Classification	PSE Emulation		Pairs	A	Polarity	MDI-X	Det_Cycles	3
Parameter Cycle	1	Units	Min.	Max.	Average	Low Lim.	High Lim.	P/F
Rdet	24.35	kohm	24.35	24.35	24.35	23.70	26.30	P
Rdet_final	24.30	kohm	24.30	24.30	24.30	23.70	26.30	P
Rdet_unpwr	>99.00	kohm	99.00	99.00	99.00	<12.00	>45.00	P
Rdet_at_Vmin	24.73	kohm	24.73	24.73	24.73	23.70	26.30	P
Rdet_at_Vmax	24.44	kohm	24.44	24.44	24.44	23.70	26.30	P
Rdet_Voffset	1.4	VDC	1.4	1.4	1.4	0.0	1.9	P
Cdet	0.11	uF	0.11	0.11	0.11	0.05	0.12	P
Cdet_final	0.11	uF	0.11	0.11	0.11	0.05	0.12	P
1 Event Classification								
Iclass	18.6	mA	18.6	18.6	18.6	17.0	20.0	P
ClassNum	2		2	2	-	0	4	P
Tclass	0.0005	sec	0.0005	0.0005	0.0005	0.0005	0.0050	P
ClassStability	1					1	1	P
Iclass_at_Vmin	18.7	mA	18.7	18.7	18.7	17.0	20.0	P
Iclass_at_Vmax	18.4	mA	18.4	18.4	18.4	17.0	20.0	P
2 Event Classification								
Iclass_event1	18.6	mA	18.6	18.6	18.6	17.0	20.0	P
Iclass_event2	18.6	mA	18.6	18.6	18.6	17.0	20.0	P
MarkI	1.62	mA	1.62	1.62	1.62	0.25	4.00	INFO
ClassNum2	2		2	2	-	0	4	P
Tclass_event1	0.0005	sec	0.0005	0.0005	0.0005	0.0005	0.0050	P
Tclass_event2	0.0005	sec	0.0005	0.0005	0.0005	0.0005	0.0050	P
ClassStability_event1	1					1	1	P
ClassStability_event2	1					1	1	P

Table 29. Si3406-ISO-FB-12 V Alt A MDI-X Test Report (Continued)

Power-Up / Down								
Parameter Cycle	1	Units	Min.	Max.	Average	Low Lim.	High Lim.	P/F
Inrush1_1	160.2	mA	160.2	160.2	160.2	0.0	400.0	P
Inrush1_2	159.8	mA	159.8	159.8	159.8	0.0	400.0	P
Pmax_Tdelay	0.2	W	0.2	0.2	0.2	0.0	8.4	P
Inrush_delayed	0		0	0	-	0	0	P
Von	37.5	VDC	37.5	37.5	37.5	30.0	42.0	P
Voff	33.4	VDC	33.4	33.4	33.4	30.0	42.0	P
Vhyst	4.1	VDC	4.1	4.1	4.1	2.8	12.0	INFO
BackfeedV	0.0	VDC	0.0	0.0	0.0	0.0	2.8	P
ClassRecover	0		0	0	-	0	0	P
SigRecoverTime	0.0	sec	0.0	0.0	0.0	0.0	30.0	P
MDI Powered Type-1	PSE Emulation		On Time	10 sec	Off Time	10 sec	Vport	38.0
Parameter Cycle	1	Units	Min.	Max.	Average	Low Lim.	High Lim.	P/F
MinI_1	8.7	mA	8.7	8.7	8.7	0.0	218.8	P
MaxI_1	15.5	mA	15.5	15.5	15.5	10.0	218.8	P
Vport_1	38.1	VDC	38.1	38.1	38.1	37.0	57.0	INFO
Ppeak_1	0.59	W	0.59	0.59	0.59	0.0	8.4	P
Pavg_1	0.41	W	0.41	0.41	0.41	0.0	6.5	P
MPSViolation_1	0		0	0	-	0	0	P
TcutWindowViolation_1	0		0	0	-	0	0	P
DutyCycleViolation_1	0		0	0	-	0	0	P
MDI Powered Type-2 PHY	PSE Emulation		On Time	10 sec	Off Time	10 sec	Vport	43.5
Parameter Cycle	1	Units	Min.	Max.	Average	Low Lim.	High Lim.	P/F
MinI_2	2.8	mA	2.8	2.8	2.8	0.0	191.3	P
MaxI_2	78.6	mA	78.6	78.6	78.6	10.0	191.3	P
Vport_2	43.7	VDC	43.7	43.7	43.7	42.5	57.0	INFO
Ppeak_2	3.43	W	3.43	3.43	3.43	0.0	8.4	P
Pavg_2	0.48	W	0.48	0.48	0.48	0.0	6.5	P
MPSViolation_2	0		0	0	-	0	0	P
TcutWindowViolation_2	0		0	0	-	0	0	P
DutyCycleViolation_2	0		0	0	-	0	0	P
MDI Powered Type-2 LLDP	PSE Emulation		On Time	-1 sec	Off Time	10 sec	Vport	-1.0
Parameter Cycle	1	Units	Min.	Max.	Average	Low Lim.	High Lim.	P/F

Table 30. Si3406-ISO-FB-12 V Alt B MDI Test Report

Detection and Classification	PSE Emulation		Pairs	B	Polarity	MDI	Det_Cycles	3
Parameter Cycle	1	Units	Min.	Max.	Average	Low Lim.	High Lim.	P/F
Rdet	24.31	kohm	24.31	24.31	24.31	23.70	26.30	P
Rdet_final	24.28	kohm	24.28	24.28	24.28	23.70	26.30	P
Rdet_unpwr	>99.00	kohm	99.00	99.00	99.00	<12.00	>45.00	P
Rdet_at_Vmin	24.73	kohm	24.73	24.73	24.73	23.70	26.30	P
Rdet_at_Vmax	24.34	kohm	24.34	24.34	24.34	23.70	26.30	P
Rdet_Voffset	1.4	VDC	1.4	1.4	1.4	0.0	1.9	P
Cdet	0.11	uF	0.11	0.11	0.11	0.05	0.12	P
Cdet_final	0.11	uF	0.11	0.11	0.11	0.05	0.12	P
1 Event Classification								
Iclass	18.7	mA	18.7	18.7	18.7	17.0	20.0	P
ClassNum	2		2	2	-	0	4	P
Tclass	0.0005	sec	0.0005	0.0005	0.0005	0.0005	0.0050	P
ClassStability	1					1	1	P
Iclass_at_Vmin	18.5	mA	18.5	18.5	18.5	17.0	20.0	P
Iclass_at_Vmax	18.1	mA	18.1	18.1	18.1	17.0	20.0	P
2 Event Classification								
Iclass_event1	18.6	mA	18.6	18.6	18.6	17.0	20.0	P
Iclass_event2	18.6	mA	18.6	18.6	18.6	17.0	20.0	P
MarkI	1.69	mA	1.69	1.69	1.69	0.25	4.00	INFO
ClassNum2	2		2	2	-	0	4	P
Tclass_event1	0.0005	sec	0.0005	0.0005	0.0005	0.0005	0.0050	P
Tclass_event2	0.0005	sec	0.0005	0.0005	0.0005	0.0005	0.0050	P
ClassStability_event1	1					1	1	P
ClassStability_event2	1					1	1	P

Table 30. Si3406-ISO-FB-12 V Alt B MDI Test Report (Continued)

Power-Up / Down								
Parameter Cycle	1	Units	Min.	Max.	Average	Low Lim.	High Lim.	P/F
InrushI_1	159.6	mA	159.6	159.6	159.6	0.0	400.0	P
InrushI_2	161.7	mA	161.7	161.7	161.7	0.0	400.0	P
Pmax_Tdelay	0.2	W	0.2	0.2	0.2	0.0	8.4	P
Inrush_delayed	0		0	0	-	0	0	P
Von	37.3	VDC	37.3	37.3	37.3	30.0	42.0	P
Voff	33.2	VDC	33.2	33.2	33.2	30.0	42.0	P
Vhyst	4.2	VDC	4.2	4.2	4.2	2.8	12.0	INFO
BackfeedV	0.1	VDC	0.1	0.1	0.1	0.0	2.8	P
ClassRecover	0		0	0	-	0	0	P
SigRecoverTime	0.0	sec	0.0	0.0	0.0	0.0	30.0	P
MDI Powered Type-1	PSE Emulation		On Time	10 sec	Off Time	10 sec	Vport	38.0
Parameter Cycle	1	Units	Min.	Max.	Average	Low Lim.	High Lim.	P/F
MinI_1	8.7	mA	8.7	8.7	8.7	0.0	219.7	P
MaxI_1	15.5	mA	15.5	15.5	15.5	10.0	219.7	P
Vport_1	38.0	VDC	38.0	38.0	38.0	37.0	57.0	INFO
Ppeak_1	0.59	W	0.59	0.59	0.59	0.0	8.4	P
Pavg_1	0.42	W	0.42	0.42	0.42	0.0	6.5	P
MPSViolation_1	0		0	0	-	0	0	P
TcutWindowViolation_1	0		0	0	-	0	0	P
DutyCycleViolation_1	0		0	0	-	0	0	P
MDI Powered Type-2 PHY	PSE Emulation		On Time	10 sec	Off Time	10 sec	Vport	43.5
Parameter Cycle	1	Units	Min.	Max.	Average	Low Lim.	High Lim.	P/F
MinI_2	2.3	mA	2.3	2.3	2.3	0.0	191.7	P
MaxI_2	65.5	mA	65.5	65.5	65.5	10.0	191.7	P
Vport_2	43.6	VDC	43.6	43.6	43.6	42.5	57.0	INFO
Ppeak_2	2.85	W	2.85	2.85	2.85	0.0	8.4	P
Pavg_2	0.48	W	0.48	0.48	0.48	0.0	6.5	P
MPSViolation_2	0		0	0	-	0	0	P
TcutWindowViolation_2	0		0	0	-	0	0	P
DutyCycleViolation_2	0		0	0	-	0	0	P
MDI Powered Type-2 LLDP	PSE Emulation		On Time	-1 sec	Off Time	10 sec	Vport	-1.0
Parameter Cycle	1	Units	Min.	Max.	Average	Low Lim.	High Lim.	P/F

Table 31. Si3406-ISO-FB-12 V Alt B MDI-X Test Report

Detection and Classification	PSE Emulation		Pairs	B	Polarity	MDI-X	Det_Cycles	3
Parameter Cycle	1	Units	Min.	Max.	Average	Low Lim.	High Lim.	P/F
Rdet	24.26	kohm	24.26	24.26	24.26	23.70	26.30	P
Rdet_final	24.28	kohm	24.28	24.28	24.28	23.70	26.30	P
Rdet_unpwr	>99.00	kohm	99.00	99.00	99.00	<12.00	>45.00	P
Rdet_at_Vmin	24.74	kohm	24.74	24.74	24.74	23.70	26.30	P
Rdet_at_Vmax	24.37	kohm	24.37	24.37	24.37	23.70	26.30	P
Rdet_Voffset	1.4	VDC	1.4	1.4	1.4	0.0	1.9	P
Cdet	0.11	uF	0.11	0.11	0.11	0.05	0.12	P
Cdet_final	0.11	uF	0.11	0.11	0.11	0.05	0.12	P
1 Event Classification								
Iclass	18.7	mA	18.7	18.7	18.7	17.0	20.0	P
ClassNum	2		2	2	-	0	4	P
Tclass	0.0005	sec	0.0005	0.0005	0.0005	0.0005	0.0050	P
ClassStability	1					1	1	P
Iclass_at_Vmin	18.6	mA	18.6	18.6	18.6	17.0	20.0	P
Iclass_at_Vmax	18.8	mA	18.8	18.8	18.8	17.0	20.0	P
2 Event Classification								
Iclass_event1	18.7	mA	18.7	18.7	18.7	17.0	20.0	P
Iclass_event2	18.6	mA	18.6	18.6	18.6	17.0	20.0	P
MarkI	1.69	mA	1.69	1.69	1.69	0.25	4.00	INFO
ClassNum2	2		2	2	-	0	4	P
Tclass_event1	0.0005	sec	0.0005	0.0005	0.0005	0.0005	0.0050	P
Tclass_event2	0.0005	sec	0.0005	0.0005	0.0005	0.0005	0.0050	P
ClassStability_event1	1					1	1	P
ClassStability_event2	1					1	1	P

Table 31. Si3406-ISO-FB-12 V Alt B MDI-X Test Report (Continued)

Power-Up / Down								
Parameter Cycle	1	Units	Min.	Max.	Average	Low Lim.	High Lim.	P/F
Inrush1_1	161.3	mA	161.3	161.3	161.3	0.0	400.0	P
Inrush1_2	161.7	mA	161.7	161.7	161.7	0.0	400.0	P
Pmax_Tdelay	0.2	W	0.2	0.2	0.2	0.0	8.4	P
Inrush_delayed	0		0	0	-	0	0	P
Von	37.4	VDC	37.4	37.4	37.4	30.0	42.0	P
Voff	33.6	VDC	33.6	33.6	33.6	30.0	42.0	P
Vhyst	3.8	VDC	3.8	3.8	3.8	2.8	12.0	INFO
BackfeedV	0.0	VDC	0.0	0.0	0.0	0.0	2.8	P
ClassRecover	0		0	0	-	0	0	P
SigRecoverTime	0.0	sec	0.0	0.0	0.0	0.0	30.0	P
MDI Powered Type-1	PSE Emulation		On Time	10 sec	Off Time	10 sec	Vport	38.0
Parameter Cycle	1	Units	Min.	Max.	Average	Low Lim.	High Lim.	P/F
MinI_1	9.1	mA	9.1	9.1	9.1	0.0	219.4	P
MaxI_1	15.5	mA	15.5	15.5	15.5	10.0	219.4	P
Vport_1	38.0	VDC	38.0	38.0	38.0	37.0	57.0	INFO
Ppeak_1	0.59	W	0.59	0.59	0.59	0.0	8.4	P
Pavg_1	0.43	W	0.43	0.43	0.43	0.0	6.5	P
MPSViolation_1	0		0	0	-	0	0	P
TcutWindowViolation_1	0		0	0	-	0	0	P
DutyCycleViolation_1	0		0	0	-	0	0	P
MDI Powered Type-2 PHY	PSE Emulation		On Time	10 sec	Off Time	10 sec	Vport	43.5
Parameter Cycle	1	Units	Min.	Max.	Average	Low Lim.	High Lim.	P/F
MinI_2	2.5	mA	2.5	2.5	2.5	0.0	191.5	P
MaxI_2	80.8	mA	80.8	80.8	80.8	10.0	191.5	P
Vport_2	43.6	VDC	43.6	43.6	43.6	42.5	57.0	INFO
Ppeak_2	3.52	W	3.52	3.52	3.52	0.0	8.4	P
Pavg_2	0.48	W	0.48	0.48	0.48	0.0	6.5	P
MPSViolation_2	0		0	0	-	0	0	P
TcutWindowViolation_2	0		0	0	-	0	0	P
DutyCycleViolation_2	0		0	0	-	0	0	P
MDI Powered Type-2 LLDP	PSE Emulation		On Time	-1 sec	Off Time	10 sec	Vport	-1.0
Parameter Cycle	1	Units	Min.	Max.	Average	Low Lim.	High Lim.	P/F