

SID11x2K SCALE-iDriver Family

Up to 8 A Single Channel IGBT/MOSFET Gate Driver
Providing Reinforced Galvanic Isolation

Product Highlights

Highly Integrated, Compact Footprint

- Split outputs providing up to 8 A peak drive current
- Integrated FluxLink™ technology providing safe isolation between primary-side and secondary-side
- Rail-to-rail stabilized output voltage
- Unipolar supply voltage for secondary-side
- Suitable for 600 V / 650 V / 1200 V IGBT and MOSFET switches
- Up to 250 kHz switching frequency
- Low propagation delay time 260 ns
- Propagation delay jitter ± 5 ns
- -40 °C to 125 °C operating ambient temperature
- High common-mode transient immunity
- eSOP package with 9.5 mm creepage and clearance

Advanced Protection / Safety Features

- Undervoltage lock-out protection for primary and secondary-side (UVLO) and fault feedback
- Short-circuit protection using V_{CESAT} monitoring and fault feedback
- Advanced Soft Shut Down (ASSD)

Full Safety and Regulatory Compliance

- 100% production partial discharge test
- 100% production HIPOT compliance testing at 6 kV RMS 1 s
- Reinforced insulation meets VDE 0884-10

Green Package

- Halogen free and RoHS compliant

Applications

- General purpose and servo drives
- UPS, solar, welding inverters and power supplies

Description

The SID11x2K is a single channel IGBT and MOSFET driver in an eSOP package. Reinforced galvanic isolation is provided by Power Integrations' innovative solid insulator FluxLink technology. The up to 8 A peak output drive current enables the product to drive devices up to 450 A (typical) without requiring any additional active components. For gate drive requirements that exceed the stand-alone capability of the SID1182K's, an external amplifier (booster) may be added. Stable positive and negative voltages for gate control are provided by one unipolar isolated voltage source.

Additional features such as short-circuit protection (DESAT) with Advanced Soft Shut Down (ASSD), undervoltage lock-out (UVLO) for primary-side and secondary-side and rail-to-rail output with temperature and process compensated output impedance guarantee safe operation even in harsh conditions.

Controller (PWM and fault) signals are compatible with 5 V CMOS logic, which may also be adjusted to 15 V levels by using external resistor divider.

Product Portfolio

Product ¹	Peak Output Drive Current
SID1112K	1.0 A
SID1132K	2.5 A
SID1152K	5.0 A
SID1182K	8.0 A

Table 1. SCALE-iDriver Portfolio.

Notes:

1. Package: eSOP-R16B.



Figure 2. eSOP-R16B Package.

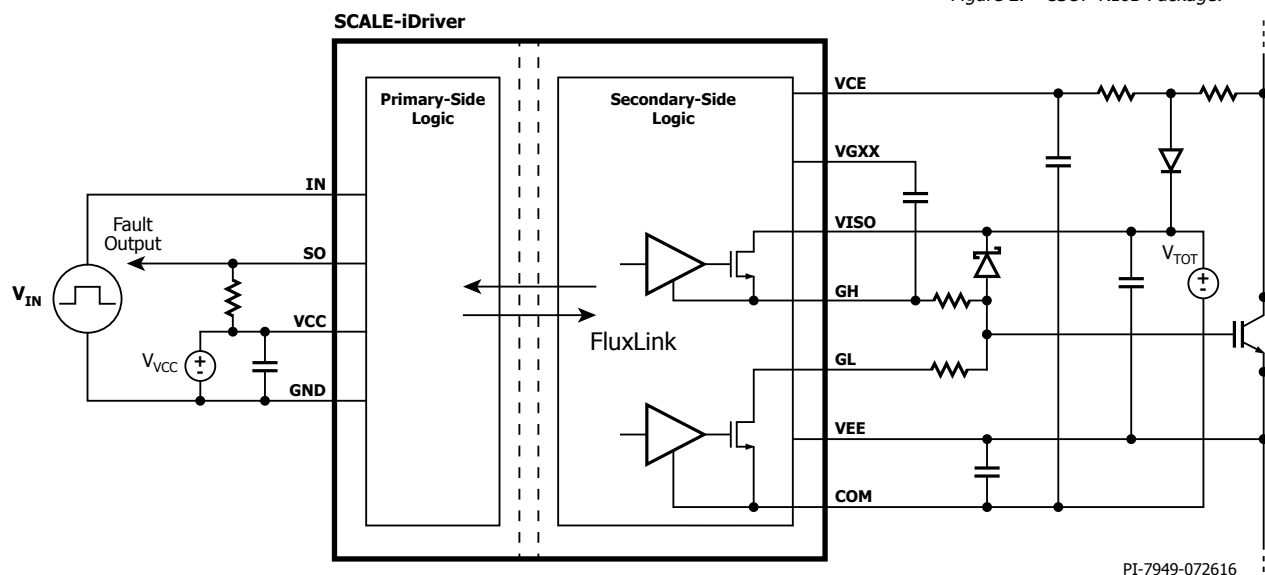
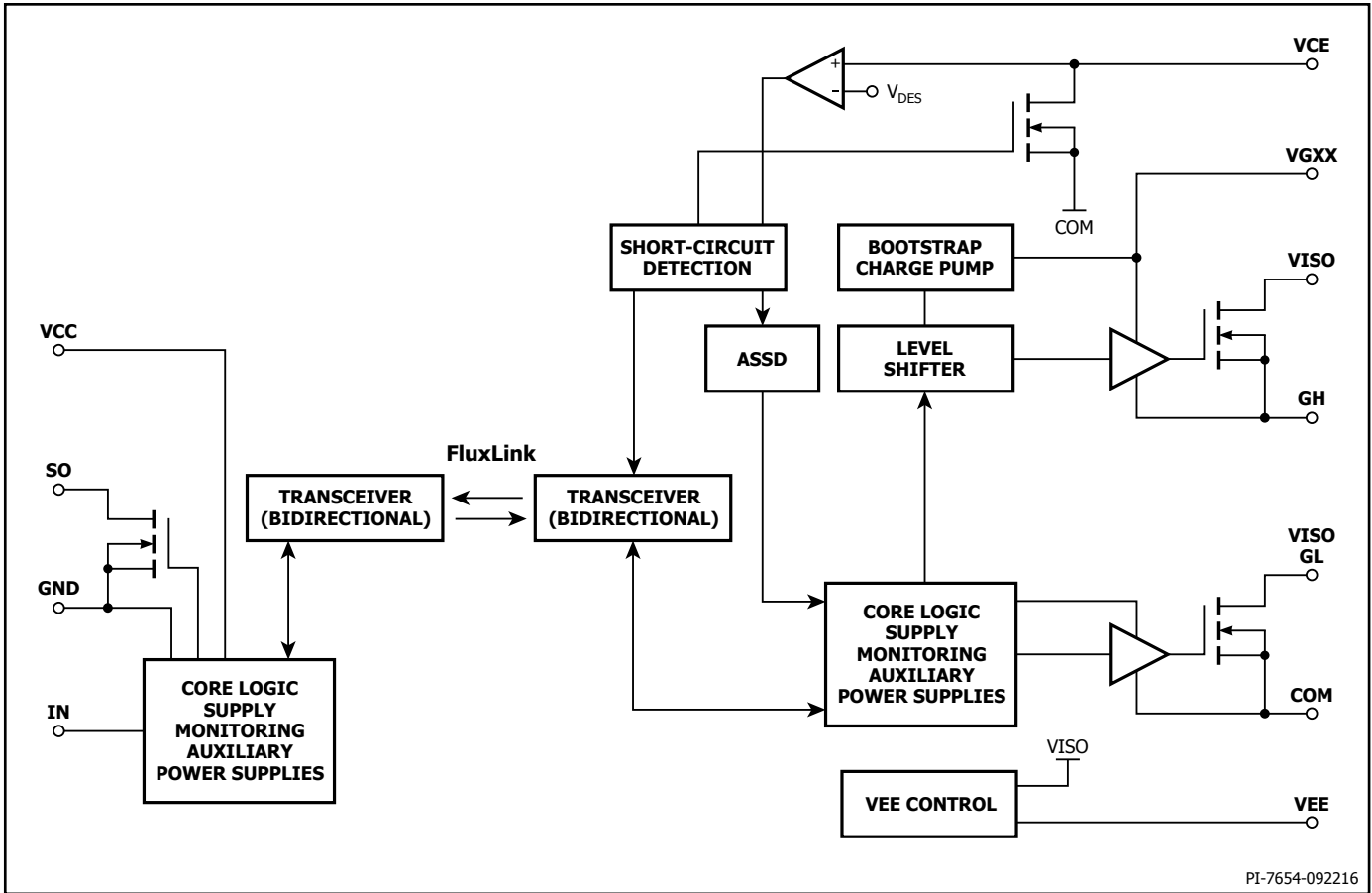

Figure 1. Typical Application Schematic.

PI-7949-072616



PI-7654-092216

Figure 3. Functional Block Diagram.

Pin Functional Description

VCC Pin (Pin 1):

This pin is the primary-side supply voltage connection.

GND Pin (Pin 3-6):

This pin is the connection for the primary-side ground potential. All primary-side voltages refer to the pin.

IN Pin (Pin 7):

This pin is the input for the logic command signal.

SO Pin (Pin 8):

This pin is the output for the logic fault signal (open drain).

NC Pin (Pin 9):

This pin must be un-connected. Minimum PCB pad size for soldering is required.

VEE Pin (Pin 10):

Common (IGBT emitter/MOSFET source) output supply voltage.

VCE Pin (Pin 11):

This pin is the desaturation monitoring voltage input connection.

VGXX Pin (Pin 12):

This pin is the bootstrap and charge pump supply voltage source.

GH Pin (Pin 13):

This pin is the driver output – sourcing current (turn-on) connection.

VISO Pin (Pin 14):

This pin is the input for the secondary-side positive supply voltage.

COM Pin (Pin 15):

This pin provides the secondary-side reference potential.

GL Pin (Pin 16):

This pin is the driver output – sinking current (turn-off).

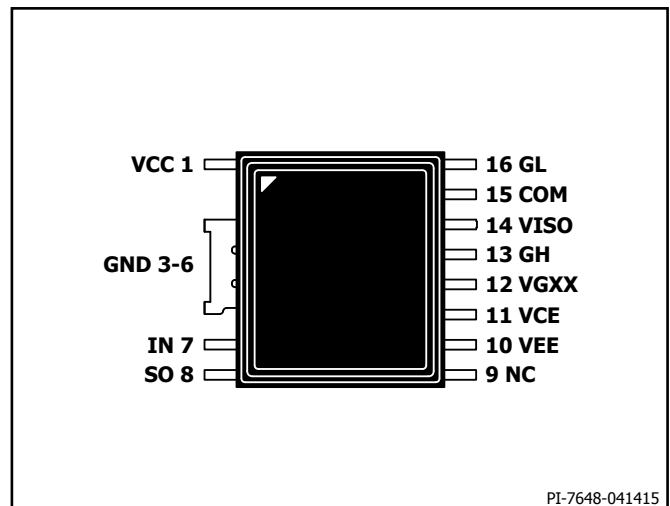

PI-7648-041415

Figure 4. Pin Configuration.

SCALE-iDriver Functional Description

The single channel SCALE-iDriver™ family is designed to drive IGBTs and MOSFETs or other semiconductor power switches with a blocking voltage of up to 1200 V and provide reinforced isolation between micro-controller and the power semiconductor switch. The logic input (PWM) command signals applied via the IN pin and the primary supply voltage supplied via the VCC pin are both reference to the GND pin. The working status of the power semiconductor switch and SCALE-iDriver is monitored via the SO pin.

PMW command signals are transferred from the primary (IN) to secondary-side via FluxLink isolation technology. The GH pin supplies a positive gate voltage and charges the semiconductor gate during the turn-on process. The GL pin supplies the negative voltage and discharges the gate during the turn-off process.

Short-circuit protection is implemented using a desaturation detection technique monitored via the VCE pin. After the SCALE-iDriver detects a short-circuit, the semiconductor turn-off process is implemented using an Advanced Soft Shut Down (ASSD) technique.

Power Supplies

The SID11x2K requires two power supplies. One is the primary-side (V_{VCC}) which powers the primary-side logic and communication with the secondary (insulated) side. One supply voltage is required for the secondary-side, V_{TOT} is applied between the VISO pin and the COM pin. V_{TOT} needs to be insulated from the primary-side and must provide at least the same insulation capabilities as the SCALE-iDriver. V_{TOT} must have a low capacitive coupling to the primary or any other secondary-side. The positive gate-emitter voltage is provided by V_{VISO} which is internally generated and stabilized to 15 V (typically) with respect to VEE. The negative gate-emitter voltage is provided by V_{VEE} with respect to COM. Due to the limited current sourcing capabilities of the VEE pin, any additional load needs to be applied between the VISO and COM pins. No additional load between VISO and VEE pins or between VEE and COM pins is allowed.

Input and Fault Logic (Primary-Side)

The input (IN) and output (SO) logic is designed to work directly with micro-controllers using 5 V CMOS logic. If the physical distance between the controller and the SCALE-iDriver is large or if a different logic level is required the resistive divider in Figure 5, or Schmitt-trigger ICs (Figures 13 and 14) can be used. Both solutions adjust the logic level as necessary and will also improve the driver's noise immunity.

Gate driver commands are transferred from the IN pin to the GH and GL pins with a propagation delay $t_{p(LH)}$ and $t_{p(HL)}$.

During normal operation, when there is no fault detected, the SO pin stays at high impedance (open). Any fault is reported by connecting the SO pin to GND. The SO pin stays low as long as the V_{VCC} voltage (primary-side) stays below $UVLO_{VCC}$ and the propagation delay is negligible. If desaturation is detected (there is a short-circuit), or the supply voltages V_{VISO} , V_{VEE} (secondary-side) drop below $UVLO_{VISO}$, $UVLO_{VEE}$ the SO status changes with a delay time t_{FAULT} and keeps status low for a time defined as t_{SO} . In case of a fault condition the driver applies the off-state (the GL pin is connected to COM). During the t_{SO} period, command signal transitions from the IN pin are ignored. A new turn-on command transition is required before the driver will enter the on-state.

The SO pin current is defined as I_{SO} ; voltage during low status is defined as $V_{SO(FAULT)}$.

Output (Secondary-Side)

The gate of the power semiconductor switch to be driven can be connected to the SCALE-iDriver output via pins GH and GL, using two different resistor values. Turn-on gate resistor R_{GON} needs to be

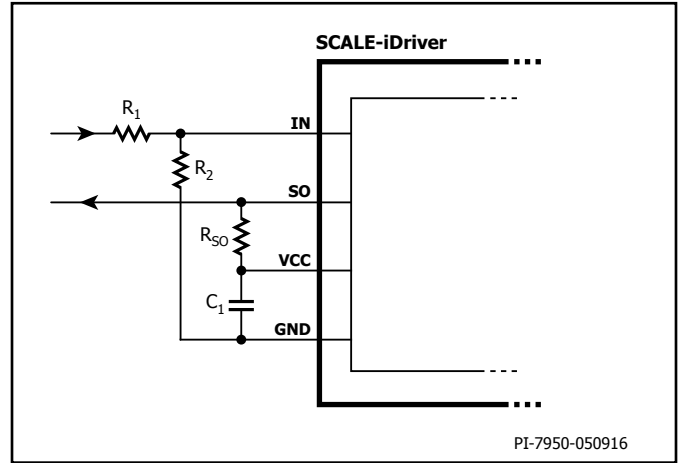

Figure 5. Increased Threshold Voltages V_{IN+LT} and V_{IN+HT} For $R_1 = 3.3\text{ k}\Omega$ and $R_2 = 1\text{ k}\Omega$ the IN Logic Level is 15 V.

connected to the GH pin and turn-off gate resistor R_{GOFF} to the GL pin. If both gate resistors have the same value, the GL and GH pins can be connected together. Note: The SCALE-iDriver data sheet defines the R_{GH} and R_{GL} values as total resistances connected to the respective pins GH and GL. Note that most power semiconductor data sheets specify an internal gate resistor R_{GINT} which is already integrated into the power semiconductor switch. In Addition to R_{GINT} , external resistor devices R_{GON} and R_{GOFF} are specified to setup the gate current levels to the application requirements. Consequently, R_{GH} is the sum of R_{GON} and R_{GINT} as shown in Figures 9 and 10. Careful consideration should be given to the power dissipation and peak current associated with the external gate resistors.

The GH pin output current source (I_{GH}) of SID1182K is capable of handling up to 7.3 A during turn-on, and the GL pin output current source (I_{GL}) is able to sink up to 8.0 A during turn-off. The SCALE-iDriver's internal resistances are described as R_{GHI} and R_{GLI} respectively. If the gate resistors for SCALE-iDriver family attempt to draw a higher peak current, the peak current will be internally limited to a safe value, see Figures 6 and 7. Figure 8 shows the peak current

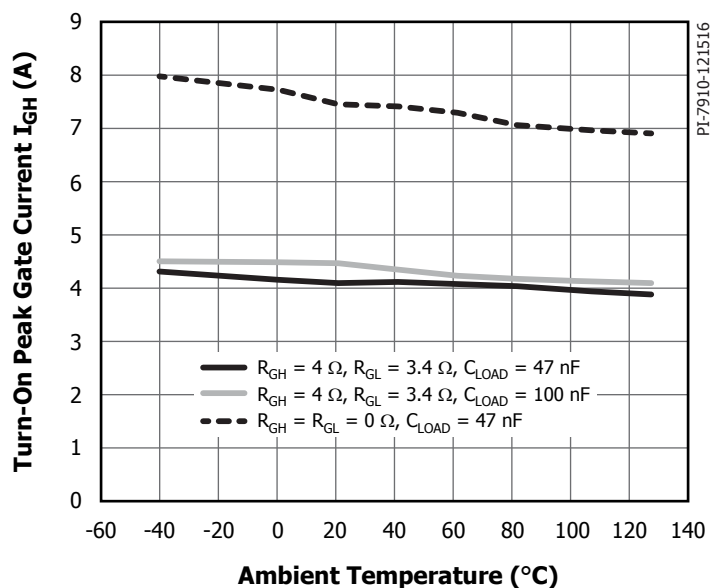

Figure 6. Turn-On Peak Output Current (Source) vs. Ambient Temperature. Conditions: $V_{CC} = 5\text{ V}$, $V_{TOT} = 25\text{ V}$, $f_s = 20\text{ kHz}$, Duty Cycle = 50%.

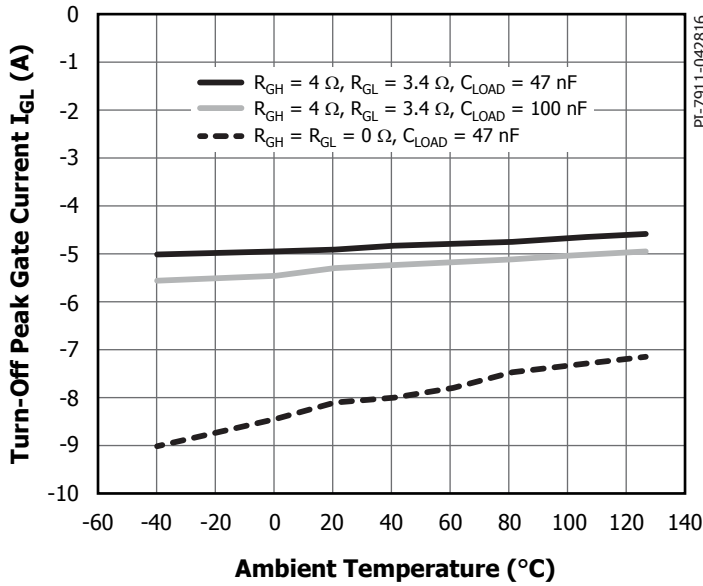

Figure 7. Turn-Off Peak Output Current (Sink) vs. Ambient Temperature. Conditions: $V_{VCC} = 5\text{ V}$, $V_{TOT} = 25\text{ V}$, $f_s = 20\text{ kHz}$, Duty Cycle = 50%

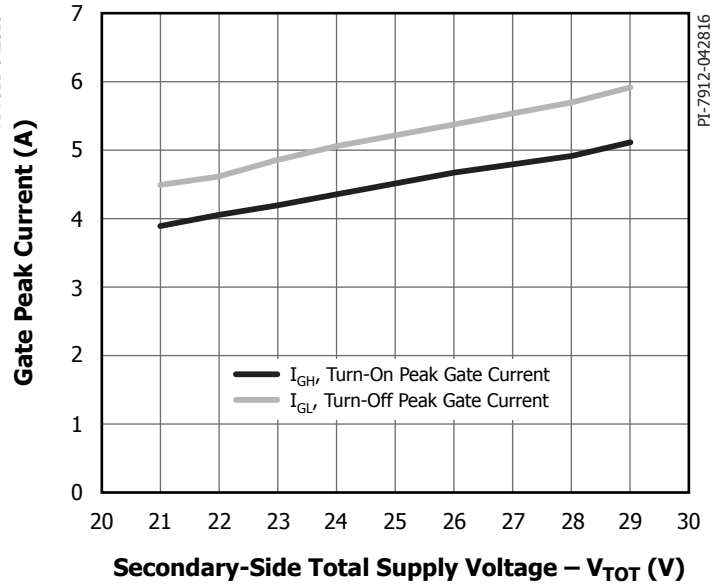

Figure 8. Turn-On and Turn-Off Peak Output Current vs. Secondary-Side Total Supply Voltage (V_{TOT}). Conditions: $V_{VCC} = 5\text{ V}$, $T_j = 25\text{ °C}$, $R_{GH} = 4\text{ Ω}$, $R_{GL} = 3.4\text{ Ω}$, $C_{LOAD} = 100\text{ nF}$, $f_s = 1\text{ kHz}$, Duty Cycle = 50%.

that can be achieved for a given supply voltage for same gate resistor values, load capacitance and layout design.

Short-Circuit Protection

The SCALE-iDriver uses the semiconductor desaturation effect to detect short-circuits and protects the device against damage by employing an Advanced Soft Shut Down (ASSD) technique. Desaturation can be detected using two different circuits, either with diode sense circuitry D_{VCE} (Figure 10) or with resistors R_{VCEX} (Figure 9). With the help of a well stabilized V_{VISO} and a Schottky diode (D_{STO}) connected between semiconductor gate and VISO pin the short-circuit current value can be limited to a safe value.

During the off-state, the VCE pin is internally connected to the COM pin and C_{RES} is discharged (red curve in Figure 11 represents the potential of the VCE pin). When the power semiconductor switch receives a turn-on command, the collector-emitter voltage (V_{CE}) decreases from the off-state level same as the DC-link voltage to a normally much lower on-state level (see blue curve in Figure 11) and C_{RES} begins to be charged up to the V_{CE} saturation level ($V_{CE\text{SAT}}$). C_{RES} charging time depends on the resistance of R_{VCEX} (Figure 9), DC-link voltage and C_{RES} and R_{VCE} value. The V_{CE} voltage during on-state is continuously observed and compared with a reference voltage, V_{DES} . The V_{DES} level is optimized for IGBT applications. As soon as $V_{CE} > V_{DES}$ (red circle in Figure 11), the driver turns off the power semiconductor switch with a controlled collector current slope, limiting the V_{CE} overvoltage excursions to below the maximum collector-emitter voltage ($V_{CE\text{ES}}$). Turn-on commands during this time and during t_{SO} are ignored, and the SO pin is connected to GND.

The response time t_{RES} is the C_{RES} charging time and describes the delay between V_{CE} asserting and the voltage on the VCE pin rising (see Figure 11). Response time should be long enough to avoid false tripping during semiconductor turn-on and is adjustable via R_{RES} and C_{RES} (Figure 10) or R_{VCE} and C_{RES} (Figure 9) values. It should not be longer than the period allowed by the semiconductor manufacturer.

Safe Power-Up and Power-Down

During driver power-up and power-down, several unintended input / output states may occur. In order to avoid these effects, it is recommended that the IN pin is kept at logic low during power-up

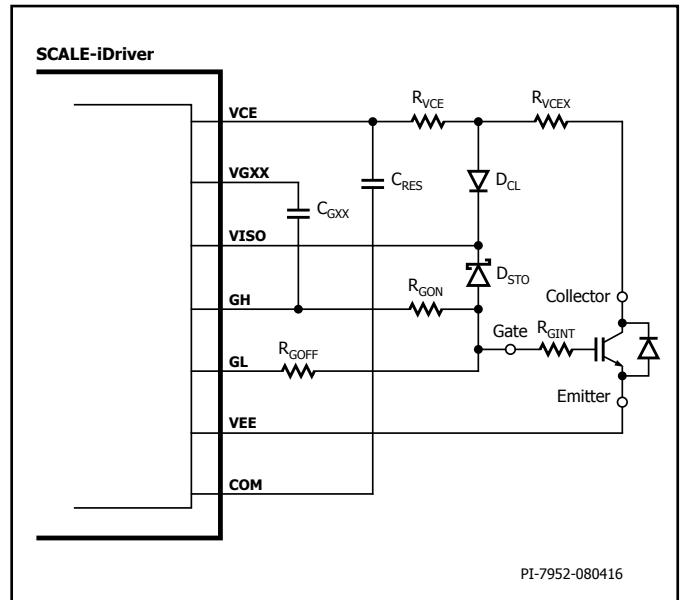

Figure 9. Short-Circuit Protection using a Resistor Chain R_{VCEX}

and power-down. Any supply voltage related to VCC, VISO, VEE and VGXX pins should be stabilized using ceramic capacitors C_1 , C_{S1X} , C_{S2X} , C_{GXX} respectively as shown in Figures 13 and 14. After supply voltages reach their nominal values, the driver will begin to function after a time delay t_{START} .

Short-Pulse Operation

If command signals applied to the IN pin are shorter than the minimum specified by $t_{GE(MIN)}$, then SCALE-iDriver output signals, GH and GL pins, will extend to value $t_{GE(MIN)}$. The duration of pulses longer than $t_{GE(MIN)}$ will not be changed.

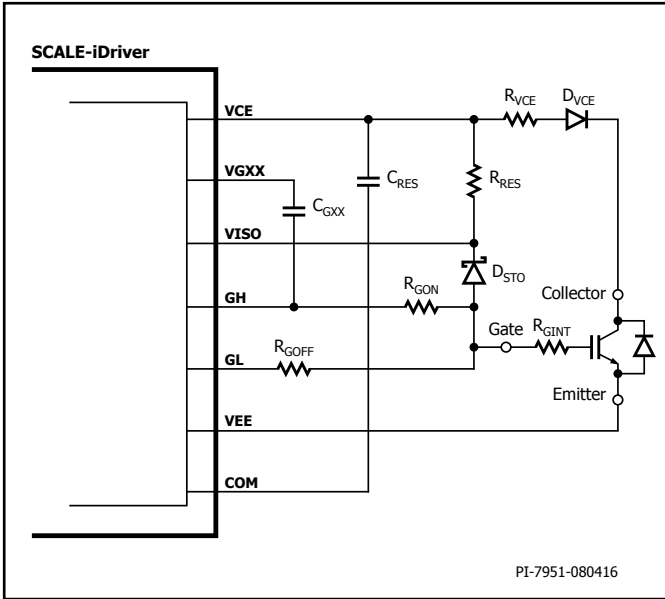

Figure 10. Short-Circuit Protection Using Rectifier Diode D_{VCE}

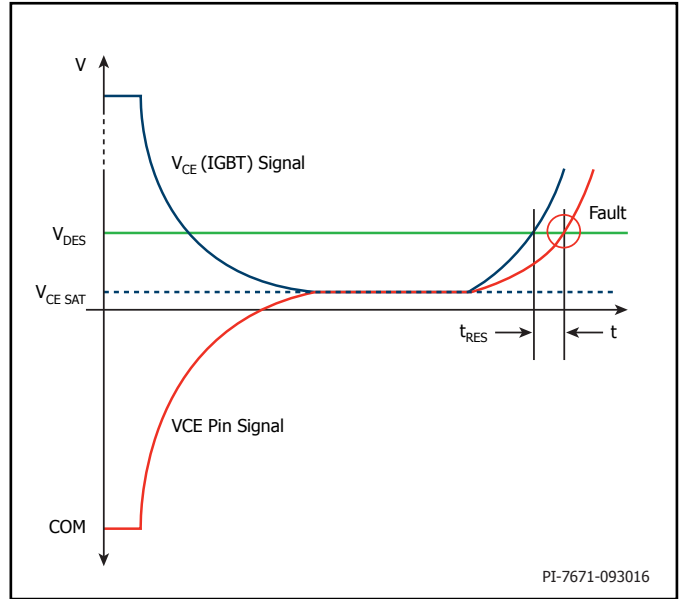

Figure 11. Short-Circuit Protection Using Resistors Chain R_{VCE}

Advanced Soft Shut Down (ASSD)

This function is activated after a short-circuit is detected. It protects the power semiconductor switch against destruction by ending the turn-on state and limiting the current slope in order to keep momentary V_{CE} overvoltages below V_{CES} . This function is particularly suited to IGBT applications. Figure 12 shows how the ASSD function operates. The V_{CE} desaturation is visible during time period P1 (yellow line). During this time, the gate-emitter voltage (green line) is kept very stable. Collector current (pink line) is also well stabilized and limited

to a safe value. At the end of period P1, V_{GE} is reduced during t_{FSSD1} . Due to collector current decrease a small V_{CE} overvoltage is seen. During t_{FSSD1} V_{GE} is further reduced and the gate of the power semiconductor switch is further discharged. During t_{FSSD2} additional small V_{CE} overvoltage events may occur. Once V_{GE} drops below the gate threshold of the IGBT, the collector current has decayed almost to zero and the remaining gate charge is removed – ending the short-circuit event. The whole short-circuit current detection and safe switch-off is lower than 10 μs (8 μs in this example).

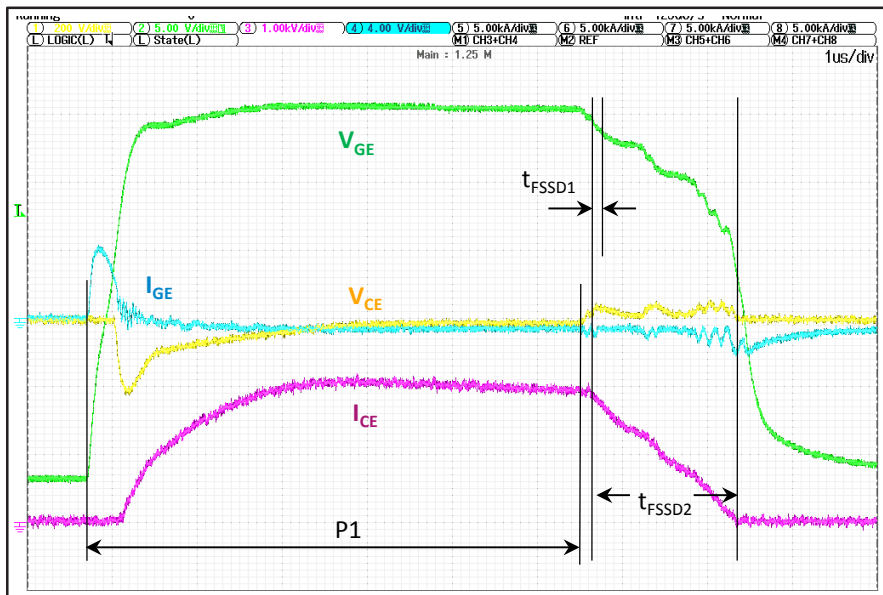

Figure 12. Advanced Soft Shut Down Function.

To avoid parasitic power-switch-conduction during system power-on, the gate is connected to COM through 6.8 kΩ resistor.

Figure 13 shows how switch desaturation can be measured using resistors $R_{VCE2} - R_{VCE11}$. In this example all the resistors have a value of 100 kΩ and 1206 size. The total resistance is 1 MΩ. The resistors should be chosen to limit current to between 0.6 mA to 0.8 mA at maximum DC-link voltage. The sum of $R_{VCE2} - R_{VCE11}$ should be approximately 1 MΩ for 1200 V semiconductors and 500 kΩ for 600 V semiconductors. In each case the resistor string must provide sufficient creepage and clearance distances between collector of the semiconductor and SCALE-iDriver. The low leakage diode D_{CL} keeps the short-circuit duration constant over a wide DC-link voltage range.

Response time is set up through R_{VCE} and C_{RES} (typically 120 kΩ and 33 pF respectively for 1200 V semiconductors). If short-circuit detection proves to be too sensitive, the C_{RES} value can be increased. The maximum short-circuit duration must be limited to the maximum value given in the semiconductor data sheet.

Figure 14 illustrates how diodes D_{VCE1} and D_{VCE2} may be used to measure switch desaturation. For insulation, two diodes in SMD packages are used (STTH212U for example). R_{RES} connected to VISO guarantees current flow through the diodes when the semiconductor is in the on-state. When the switch desaturates, C_{RES} starts to be charged through R_{RES} . In this configuration the response time is controlled by R_{RES} and C_{RES} . In this application example $C_{RES} = 33$ pF and $R_{RES} = 62$ kΩ; if desaturation is too sensitive or the short-circuit duration too long, both C_{RES} and R_{RES} can be adjusted.

Figure 15 shows the recommended PCB layout and corresponds to the schematic in Figure 13. The PCB is a two layer design. It is important to ensure that PCB traces do not cover the area below the desaturation resistors or diodes D_{VCE1} and D_{VCE2} . This is a critical design requirement to avoid coupling capacitance with the SCALE-iDriver's VCE pin and isolation issues within the PCB.

Gate resistors are located physically close to the power semiconductor switch. As these components can get hot, it is recommended that they are placed away from the SCALE-iDriver.

Power Dissipation and IC Junction Temperature Estimation

First calculation in designing the power semiconductor switch gate driver stage is to calculate the required gate power - P_{DRV} . The power is calculated based on equation 1:

$$P_{DRV} = Q_{GATE} \times f_s \times V_{TOT} \quad (1)$$

where,

Q_{GATE} – Controlled power semiconductor switch gate charge (derived for the particular gate potential range defined by V_{TOT}). See semiconductor manufacturer data sheet.

f_s – Switching frequency which is same as applied to the IN pin of SCALE-iDriver.

V_{TOT} – SCALE-iDriver secondary-side supply voltage.

In addition to P_{DRV} , P_P (primary-side IC power dissipation) and P_{SNL} (secondary-side IC power dissipation without capacitive load) must be considered. Both are ambient temperature and switching frequency dependent (see typical performance characteristics).

$$P_P = V_{VCC} \times I_{VCC} \quad (2)$$

$$P_{SNL} = V_{TOT} \times I_{VISO} \quad (3)$$

During IC operation, the P_{DRV} power is shared between turn-on (R_{GH}), turn-off (R_{GL}) external gate resistors and internal driver resistances R_{GHI} and R_{GLI} . For junction temperature estimation purposes, the dissipated power under load (P_{OL}) inside the IC can be calculated accordingly to equation 4:

$$P_{OL} = 0.5 \times Q_{GATE} \times f_s \times V_{TOT} \times \left(\frac{R_{GHI}}{R_{GHI} + R_{GH}} + \frac{R_{GLI}}{R_{GLI} + R_{GL}} \right) \quad (4)$$

R_{GH} and R_{GL} represent sum of external (R_{GON} , R_{GOFF}) and power semiconductor internal gate resistance (R_{GINT}):

$$R_{GH} = R_{GON} + R_{GINT}$$

$$R_{GL} = R_{GOFF} + R_{GINT}$$

Total IC power dissipation (P_{DIS}) is estimated as sum of equations 2, 3 and 4:

$$P_{DIS} = P_P + P_{SNL} + P_{OL} \quad (5)$$

The operating junction temperature (T_J) for given ambient temperature (T_A) can be estimated according to equation 6:

$$T_J = \theta_{JA} \times P_{DIS} + T_A \quad (6)$$

Example

An example is given below,

$f_s = 20$ kHz, $T_A = 85$ °C, $V_{TOT} = 25$ V, $V_{VCC} = 5$ V.

$Q_{GATE} = 2.5$ μC (the gate charge value here should correspond to selected V_{TOT}), $R_{GINT} = 2.5$ Ω, $R_{GON} = R_{GOFF} = 1.8$ Ω.

$P_{DRV} = 2.5$ μC × 20 kHz × 25 V = 1.25 W, according to equation 1.

$P_P = 5$ V × 13.5 mA = 67 mW, according to equation 2 (see Figure 18).

$P_{SNL} = 25$ V × 7.5 mA = 185 mW, according to equation 3 (see Figure 20).

The dissipated power under load is:

$$P_{OL} = 0.5 \times 2.5 \mu C \times 20 \text{ kHz} \times 25 \text{ V} \times \left(\frac{1.45 \Omega}{1.45 \Omega + 4.3 \Omega} + \frac{1.2 \Omega}{1.2 \Omega + 4.3 \Omega} \right) \cong 0.3 \text{ W},$$

according to equation 4.

$R_{GHI} = 1.45$ Ω as maximum data sheet value.

$R_{GLI} = 1.2$ Ω as maximum data sheet value.

$R_{GH} = R_{GL} = 1.8$ Ω + 2.5 Ω = 4.3 Ω.

$P_{DIS} = 67$ mW + 185 mW + 300 mW = 552 mW according to equation 5.

$T_J = 67$ °C/W × 552 mW + 85 °C = 122 °C according to equation 6.

Estimated junction temperature for this design would be approximately 122 °C and is lower than the recommended maximum value. As the gate charge is not adjusted to selected V_{TOT} and internal IC resistor values are maximum values, it is understood that the example represents worst-case conditions.

Table 2 describes the recommended capacitor and resistor characteristics and layout requirements to achieve optimum performances of SCALE-iDriver.

Pin	Return to Pin	Recommended Value	Symbol	Notes
VCC	GND	4.7 μ F	C_1	VCC blocking capacitor needs to be placed close to IC. Enlarged loop could result in inadequate VCC supply voltage during operation.
VISO	VEE	4.7 μ F	C_{S21}/C_{S22}	25V X7R type is recommended. Example part number could be Murata 25 V part #GRM31CR71E475KA88. This capacitor needs to be close to IC pins.
VEE	COM	4.7 μ F	C_{S11}/C_{S12}	25 V X7R type is recommended. Example part number could be Murata 25 V part #GRM31CR71E-475KA88. This capacitor needs to be close to IC pins.
VGXX	GH	10 nF	C_{GXX}	To avoid mis-operation, this pin should not be connected to anything else. This capacitor needs to be as close to IC pins as possible. 25 V X7R type is recommended. Example part number could be Yageo 25 V part#CC0603KRX7R9BB103.
VCE	COM	33 pF	C_{RES}	Select C_{RES} to achieve needed desaturation protection response time. 50 V COG/NPO is recommended. A value of 33 pF is initially recommended. Example part number could be KEMET 50 V part C0603C330J5GACTU. Any net and any other layer should provide sufficient distance to components C_{RES} in order to avoid parasitic effects (capacitance)
VCE			$R_{VCE}, D_{VCE}, C_{RES}, R_{RES}, D_{CL}$	Select R_{VCE} or R_{RES} for the proper operation of the short-circuit protection. Any net and any other layer should provide sufficient distance to components $R_{VCE}, D_{VCE}, R_{RES}$ and D_{CL} in order to avoid parasitic effects.

Table 2. PCB Layout and Component Guidelines.

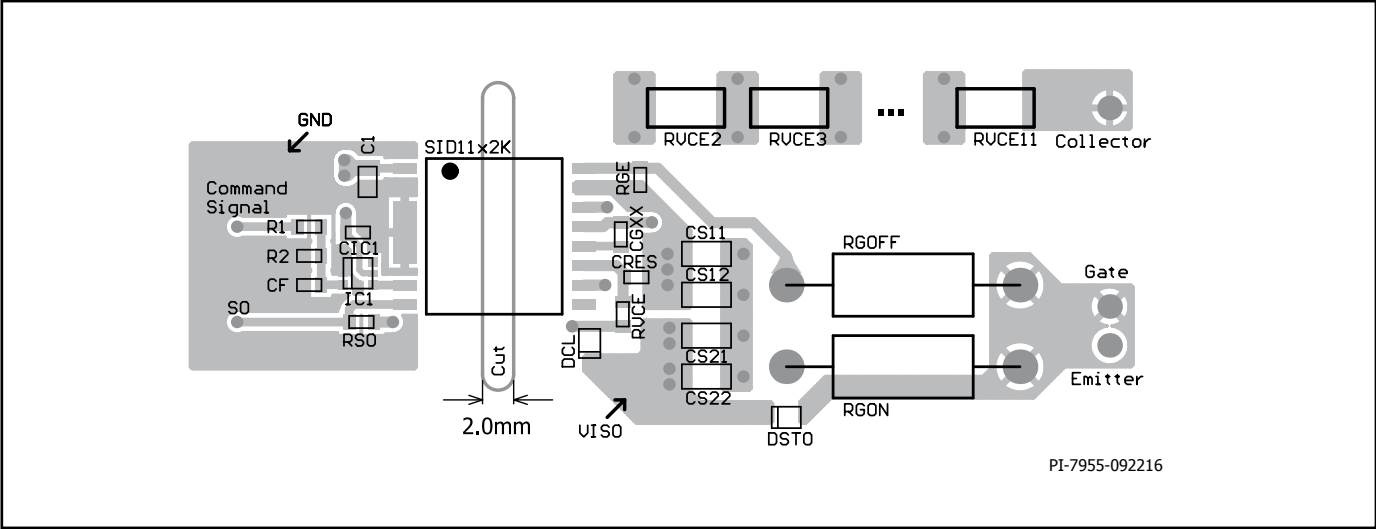

Figure 15a. Top View of Recommended PCB Layout. Corresponds to Schematic Shown in Figure 13.

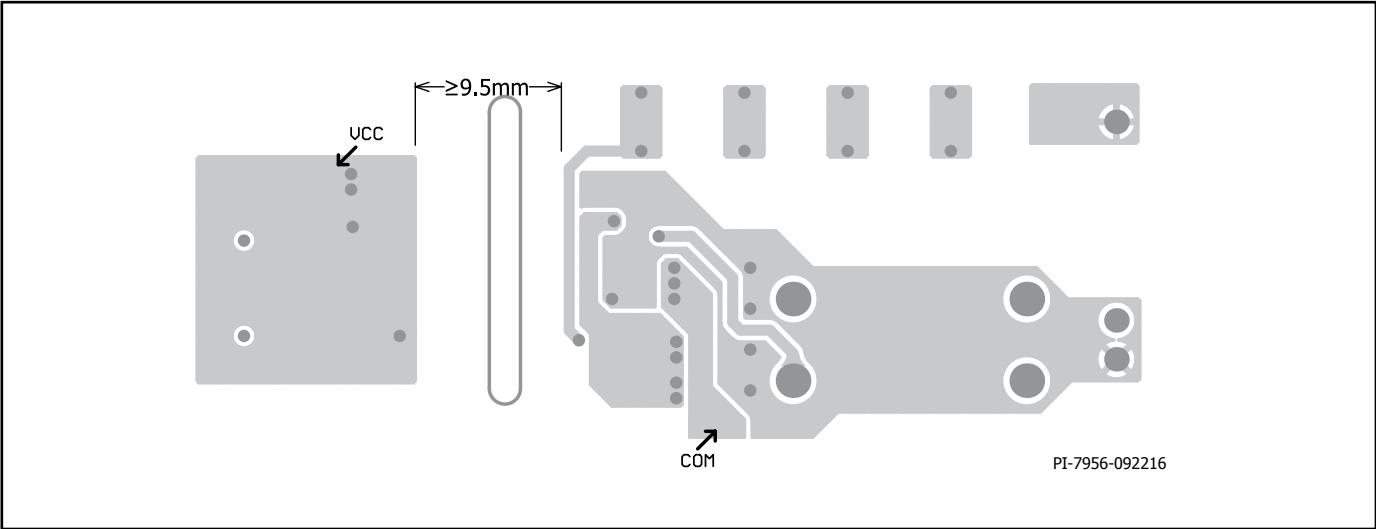

Figure 15b. Bottom View of Recommended PCB Layout. Corresponds to Schematic Shown in Figure 13.

Parameter	Symbol	Conditions	Min	Max	Units
Absolute Maximum Ratings¹					
Primary-Side Supply Voltage ²	V_{VCC}	VCC to GND	-0.5	6.5	V
Secondary-Side Total Supply Voltage	V_{TOT}	VISO to COM	-0.5	30	V
Secondary-Side Positive Supply Voltage	V_{VISO}	VISO to VEE	-0.5	17.5	V
Secondary-Side Negative Supply Voltage	V_{VEE}	VEE to COM	-0.5	15	V
Logic Input Voltage (command signal)	V_{IN}	IN to GND	-0.5	$V_{VCC} + 0.5$	V
Logic Output Voltage (fault signal)	V_{SO}	SO to GND	-0.5	$V_{VCC} + 0.5$	V
Logic Output Current (fault signal)	I_{SO}	Positive Current Flowing into the Pin		10	mA
VCE Pin Voltage	V_{VCE}	VCE - COM	-0.5	$V_{TOT} + 0.5$	V
Switching Frequency	f_s			250	kHz
Storage Temperature	T_s		-65	150	°C
Operating Junction Temperature	T_j		-40	150 ³	°C
Operating Ambient Temperature	T_A		-40	125	°C
Operating Case Temperature	T_C		-40	125	°C
Input Power Dissipation ⁴	P_p	$V_{VCC} = 5\text{ V}, V_{TOT} = 28\text{ V},$ $T_A = 25\text{ °C}$ $f_s = 250\text{ kHz}$		188	mW
Output Power Dissipation ⁴	P_s			1602	
Total IC Power Dissipation ⁴	P_{DJS}			1790	

NOTES:

- Stresses beyond those listed under absolute maximum ratings may cause permanent damage to the device.
- Defined as peak voltage measured directly on VCC pin.
- Transmission of command signals could be affected by PCB layout parasitic inductances at junction temperatures higher than recommended.
- Input Power Dissipation refers to equation 2. Output Power Dissipation is secondary-side IC power dissipation without capacitive load (P_{SNL} , equation 3) and dissipated power under load (P_{OL} , equation 4). Total IC power dissipation is sum of P_p and P_s .

Thermal Resistance

Thermal Resistance: eSOP-R16B Package:

Primary-side (θ_{JA})	51 °C/W ¹
Secondary-side (θ_{JA})	67 °C/W ¹
Primary-side (θ_{JC})	22 °C/W ²
Secondary-side (θ_{JC})	34 °C/W ²

Notes:

- 2 oz. (610 g/m²) copper clad. Measured with layout shown in Figure 15.
- The case temperature is measured at the plastic surface at the top of the package.

Parameter	Conditions	Rating	Units
Ratings for UL1577			
Primary-Side Current Rating	Current at Pin 1 (VCC) $T_A = 125\text{ °C}$	34	mA
Primary-Side Power Rating	$T_A = 25\text{ °C}$	180	mW
Secondary-Side Current Rating	Current at Pin 14 (VISO) $T_A = 125\text{ °C}$	27	mA
	Peak Current at Pin 13 (GH) / 16 (GL), $T_A = 125\text{ °C}$ Frequency = 250 kHz (SID1182K)	6.1	A
	Peak Current at Pin 13 (GH) / 16 (GL), $T_A = 125\text{ °C}$ Frequency = 250 kHz (SID1152K)	4	
Peak Current at Pin 13 (GH) / 16 (GL), $T_A = 125\text{ °C}$ Frequency = 250 kHz (SID1132K)	2		
Secondary-Side Power Rating	$T_A = 25\text{ °C}$	800	mW

Parameter	Symbol	Conditions	Min	Typ	Max	Units
		$T_j = -40\text{ °C to }+125\text{ °C}$ See Note 1 (Unless Otherwise Specified)				
Recommended Operation Conditions						
Primary-Side Supply Voltage	V_{VCC}	VCC – GND	4.75		5.25	V
Secondary-Side Total Supply Voltage	V_{TOT}	VISO – COM	22		28	V
Logic Low Input Voltage	V_{IL}				0.5	V
Logic High Input Voltage	V_{IH}		3.3			V
Switching Frequency	f_s		0		75	kHz
Operating IC Junction Temperature	T_j		-40		125	°C
Electrical Characteristics						
Logic Low Input Threshold Voltage	V_{IN+LT}	$f_s = 0\text{ Hz}$	0.6	1.25	1.8	V
Logic High Input Threshold Voltage	V_{IN+HT}	$f_s = 0\text{ Hz}$	1.7	2.2	3.05	V
Logic Input Voltage Hysteresis	V_{IN+HS}	$f_s = 0\text{ Hz}$	0.1			V
Input Bias Current	I_{IN}	$V_{IN} = 5\text{ V}$	56	113	165	μA
		$V_{IN} > 3\text{ V}$ See Note 12		106		
Supply Current (Primary-Side)	I_{VCC}	$V_{IN} = 0\text{ V}$	4	11	17	mA
		$V_{IN} = 5\text{ V}$		16	23	
		$f_s = 20\text{ kHz}$		14.5	20	
		$f_s = 75\text{ kHz}$		16.3	23	
Supply Current (Secondary-Side)	I_{VISO}	$V_{IN} = 0\text{ V}$		6	8	mA
		$V_{IN} = 5\text{ V}$		7	9	
		$f_s = 20\text{ kHz}$		7.4	10	
		$f_s = 75\text{ kHz}$		10.3	14	
Power Supply Monitoring Threshold (Primary-Side)	$UVLO_{VCC}$	Clear Fault		4.28	4.65	V
		Set Fault	3.85	4.12		
		Hysteresis, See Notes 3, 4	0.02			
Power Supply Monitoring Threshold (Secondary-Side, Positive Rail V_{VISO})	$UVLO_{VISO}$	Clear Fault		12.85	13.5	V
		Set Fault, Note 3	11.7	12.35		
		Hysteresis	0.3			
Power Supply Monitoring Blanking Time, V_{VISO}	$UVLO_{VISO(BL)}$	Voltage Drop 13.5 V to 11.5 V See Note 12	0.5			μs
Power Supply Monitoring Threshold (Secondary-Side, Negative Rail V_{VEE})	$UVLO_{VEE}$	Clear Fault, $V_{TOT} = 20\text{ V}$		5.15	5.5	V
		Set Fault, $V_{TOT} = 20\text{ V}$	4.67	4.93		
		Hysteresis	0.1			

Parameter	Symbol	Conditions		Min	Typ	Max	Units	
		$T_j = -40\text{ °C to }+125\text{ °C}$ See Note 1 (Unless Otherwise Specified)						
Electrical Characteristics (cont.)								
Power Supply Monitoring Blanking Time, V_{VEE}	$UVLO_{VEE(BL)}$	Voltage Drop 5.5 V to 4.5 V See Note 12		0.5			μS	
Secondary-Side Positive Supply Voltage Regulation	$V_{VISO(HS)}$	$21\text{ V} \leq V_{TOT} \leq 30\text{ V}$, $ i(V_{VEE}) \leq 1.5\text{ mA}$		14.4	15.07	15.75	V	
VEE Source Capability	$I_{VEE(SO)}$	$V_{TOT} = 15\text{ V}$, V_{VEE} set to 0 V		0.1			mA	
		$V_{TOT} = 25\text{ V}$, V_{VEE} set to 7.5 V See Note 13		1.85	3.3	4.5		
VEE Sink Capability	$I_{VEE(SI)}$	$V_{TOT} = 25\text{ V}$, V_{VEE} set to 12.5 V See Note 13		1.74	3.1	4.5	mA	
DESAT Detection Level	V_{DES}	VCE-VEE, $V_{IN} = 5\text{ V}$		7.2	7.8	8.3	V	
DESAT Sink Current	I_{DES}	$V_{VCE} = 10\text{ V}$, $V_{IN} = 0\text{ V}$		15	28	50	mA	
DESAT Bias Current	$I_{DES(BS)}$	$V_{VCE} - V_{VEE} = 4.5\text{ V}$, $V_{IN} = 5\text{ V}$		-0.5		3	μA	
VCE Pin Capacitance	C_{VCE}	Between VCE and COM pins, See Note 12			12.5		pF	
Turn-On Propagation Delay	$t_{P(LH)}$	$T_j = 25\text{ °C}$, See Note 5		180	253	340	ns	
		$T_j = 125\text{ °C}$, See Note 5		210	278	364		
Turn-Off Propagation Delay	$t_{P(HL)}$	$T_j = 25\text{ °C}$, See Note 6		200	262	330	ns	
		$T_j = 125\text{ °C}$, See Note 6		211	287	359		
Minimum Turn-On and Off Pulses	$t_{GE(MIN)}$	See Note 12				650	ns	
Output Rise Time	t_R	No C_G , See Note 7			22	45	ns	
		$C_G = 10\text{ nF}$, See Note 7	SID1112K See Note 12					1125
			SID1132K See Note 12					450
			SID1152K See Note 12					225
			SID1182K		55	90		150
		$C_G = 47\text{ nF}$, See Note 7	SID1112K See Note 12					N/A
			SID1132K See Note 12					1950
			SID1152K See Note 12					975
SID1182K			300	465	650			

Parameter	Symbol	Conditions $T_J = -40\text{ }^\circ\text{C to } +125\text{ }^\circ\text{C}$ See Note 1 (Unless Otherwise Specified)	Min	Typ	Max	Units		
Electrical Characteristics (cont.)								
Output Fall Time	t_F	No C_G , See Note 8			18	45	ns	
		$C_G = 10\text{ nF}$ See Note 8	SID1112K See Note 12			1125		
			SID1132K See Note 12			450		
			SID1152K See Note 12			225		
			SID1182K	40	81	150		
		$C_G = 47\text{ nF}$ See Note 8	SID1112K See Note 12			N/A		
			SID1132K See Note 12			1950		
			SID1152K See Note 12			975		
			SID1182K	300	460	650		
		ASSD Rate of Change	t_{FSSD1}	VGE change from 14.5 V to 14 V, See Note 12		60		
t_{FSSD2}	VGE change from 14.5 V to 2.5 V, See Note 12		950	1828	2800			
Propagation Delay Jitter		See Note 12		± 5		ns		
Fault Signalization Delay Time	t_{FAULT}	See Note 10		190	750	ns		
SO Fault Signalization time	t_{SO}		6.8	10	13.4	μs		
Power-On Start-Up Time	t_{START}	See Note 11			10	ms		
Gate Sourcing Peak Current GH Pin	I_{GH}	$V_{GH} \geq V_{TOT} - 8.8\text{ V}$ $C_G = 470\text{ nF}$ See Note 13	SID1112K See Note 12	0.48			A	
			SID1132K See Note 12	1.2				
			SID1152K See Note 12	2.4				
			SID1182K	3.6	4.6	5.5		
		$R_G = 0, C_G = 47\text{ nF}$ See Notes 2, 12, 13	SID1112K		0.96			
			SID1132K		2.4			
			SID1152K		4.8			
			SID1182K		7.3			

Parameter	Symbol	Conditions		Min	Typ	Max	Units	
		$T_J = -40\text{ }^\circ\text{C to } +125\text{ }^\circ\text{C}$ See Note 1 (Unless Otherwise Specified)						
Electrical Characteristics (cont.)								
Gate Sinking Peak Current GL Pin	I_{GL}	$V_{GL} \leq 7.5\text{ V}$ $C_G = 470\text{ nF}$ V_{GL} is Referenced to COM	SID1112K See Note 12	0.52			A	
			SID1132K See Note 12	1.3				
			SID1152K See Note 12	2.6				
			SID1182K	4	4.8	5.5		
		$R_G = 0, C_G = 47\text{ nF}$ See Notes 2, 12	SID1112K		1.04			
			SID1132K		2.6			
			SID1152K		5.2			
			SID1182K		7.8			
Turn-On Internal Gate Resistance	R_{GHI}	$I(GH) = -250\text{ mA}$ $V_{IN} = 5\text{ V}$	SID1112K See Note 12			12	Ω	
			SID1132K See Note 12			4.8		
			SID1152K See Note 12			2.4		
			SID1182K		0.76	1.2		
Turn-Off Internal Gate Resistance	R_{GLI}	$I(GL) = 250\text{ mA}$ $V_{IN} = 0\text{ V}$	SID1112K See Note 12			10	Ω	
			SID1132K See Note 12			4		
			SID1152K See Note 12			2		
			SID1182K		0.68	1.1		
Turn-On Gate Output Voltage	$V_{GH(ON)}$	$I(GH) = 2\text{ mA}$ $V_{IN} = 5\text{ V}$, See Note 13	SID1112K See Note 12	$V_{TOT} - 0.04$			V	
		$I(GH) = 6.6\text{ mA}$ $V_{IN} = 5\text{ V}$, See Note 13	SID1132K See Note 12					
		$I(GH) = 10\text{ mA}$ $V_{IN} = 5\text{ V}$, See Note 13	SID1152K See Note 12					
		$I(GH) = 20\text{ mA}$ $V_{IN} = 5\text{ V}$, See Note 13	SID1182K					
Turn-Off Gate Output Voltage (Referred to COM Pin)	$V_{GL(OFF)}$	$I(GL) = -2\text{ mA}$ $V_{IN} = 0\text{ V}$	SID1112K See Note 12			0.04	V	
		$I(GL) = -6.6\text{ mA}$ $V_{IN} = 0\text{ V}$	SID1132K See Note 12					
		$I(GL) = -10\text{ mA}$ $V_{IN} = 0\text{ V}$	SID1152K See Note 12					
		$I(GL) = -20\text{ mA}$ $V_{IN} = 0\text{ V}$	SID1182K					
SO Output Voltage	$V_{SO(FAULT)}$	Fault Condition, $I_{SO} = 3.4\text{ mA}$, $V_{VCC} \geq 3.9\text{ V}$			210	450	mV	

Parameter	Symbol	Conditions				Units
		$T_J = -40\text{ °C to }+125\text{ °C}$ See Note 1 (Unless Otherwise Specified)				
Package Characteristics (See Notes 12, 14)						
Distance Through the Insulation	DTI	Minimum Internal Gap (Internal Clearance)	0.4			mm
Minimum Air Gap (Clearance)	L1 (IO1)	Shortest Terminal-to-Terminal Distance Through Air	9.5			mm
Minimum External Tracking (Creepage)	L2 (IO2)	Shortest Terminal-to-Terminal Distance Across the Package Surface	9.5			mm
Tracking Resistance (Comparative Tracking Index)	CTI	DIN EN 60112 (VDE 0303-11): 2010-05 EN / IEC 60112:2003 + A1:2009	600			
Isolation Resistance, Input to Output See Note 16	R_{IO}	$V_{IO} = 500\text{ V}, T_J = 25\text{ °C}$	10^{12}			Ω
		$V_{IO} = 500\text{ V}, 100\text{ °C} \leq T_J \leq T_{C(MAX)}$	10^{11}			
Isolation Capacitance, Input to Output See Note 16	C_{IO}			1		pF
Package Insulation Characteristics						
Maximum Working Isolation Voltage	V_{IOWM}				1000	V_{RMS}
Maximum Repetitive Peak Isolation Voltage	V_{IORM}				1414	V_{PEAK}
Input to Output Test Voltage	V_{PD}	Method A, After Environmental Tests Subgroup 1, $V_{PR} = 1.6 \times V_{IORM}$, $t = 10\text{ s}$ (qualification) Partial Discharge < 5 pC			2263	V_{PEAK}
		Method A, After Input/Output Safety Test Subgroup 2/3, $V_{PR} = 1.2 \times V_{IORM}$, $t = 10\text{ s}$, (qualification) Partial Discharge < 5 pC			1697	
		Method B1, 100% Production Test, $V_{PR} = 1.875 \times V_{IORM}$, $t = 1\text{ s}$ Partial Discharge < 5 pC			2652	
Maximum Transient Isolation Voltage	V_{IOTM}	$V_{TEST} = V_{IOTM}$, $t = 60\text{ s}$ (qualification), $t = 1\text{ s}$ (100% production)			8000	V_{PEAK}
Maximum Surge Isolation Voltage	V_{IOSM}	Test Method Per IEC 60065, 1.2/50 μs Waveform, $V_{TEST} = 1.6 \times V_{IOSM} = 12800\text{ V}$ (qualification)			8000	V_{PEAK}
Insulation Resistance	R_S	$V_{IO} = 500\text{ V}$ at T_S			$>10^9$	Ω
Maximum Case Temperature	T_S				150	$^{\circ}\text{C}$
Safety Total Dissipated Power	P_S	$T_A = 25\text{ °C}$			1.79	W
Pollution Degree				2		
Climatic Classification				40/125/21		
Withstanding Isolation Voltage	V_{ISO}	$V_{TEST} = V_{ISO}$, $t = 60\text{ s}$ (qualification), $V_{TEST} = 1.2 \times V_{ISO} = 6000\text{ V}_{RMS}$, $t = 1\text{ s}$ (100% production)			5000	V_{RMS}

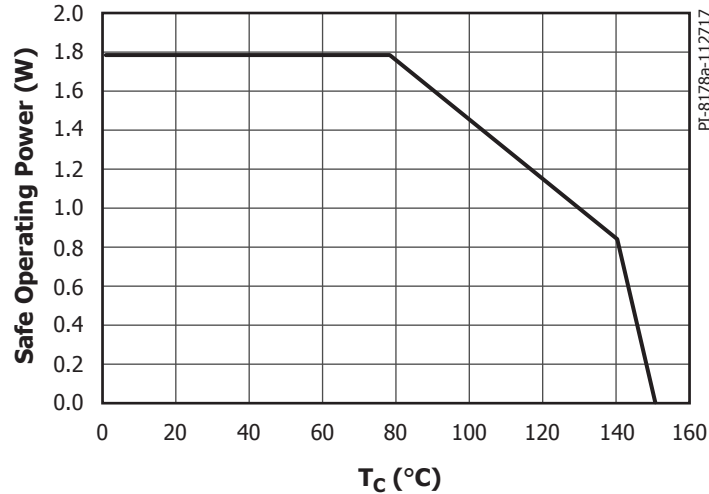

Figure 16. Thermal Derating Curve Showing Dependence of Limited Dissipated Power on Case Temperature (DIN V VDE V 0884-10).

Continuous device operating is allowed until T_J and/or T_C of 125 °C are reached. Thermal stress beyond those values but below thermal derating curve may lead to permanent functional product damage. Operating beyond thermal SR derating curve may affect product reliability.

NOTES:

1. $V_{VCC} = 5\text{ V}$, $V_{TOT} = 25\text{ V}$; GH and GL pins are shorted together. $R_G = 4\ \Omega$, No C_G ; VCC pin is connected to the SO pin through a 2 k Ω resistor. The VGXX pin is connected to the GH pin through a 10 nF capacitor. Typical values are defined at $T_A = 25\text{ °C}$; $f_s = 20\text{ kHz}$, Duty Cycle = 50%. Positive currents are assumed to be flowing into pins.
2. Pulse width $\leq 10\ \mu\text{s}$, duty cycle $\leq 1\%$. The maximum value is controlled by the ASIC to a safe level. There is no need to limit the current by the application. The internal peak power is safely controlled for $R_G \geq 0$ and power semiconductor module input gate capacitance $C_{IES} \leq 47\text{ nF}$.
3. During very slow V_{VCC} power-up and power-down related to V_{TOT} , V_{VCC} and V_{VEE} respectively, several SO fault pulses may be generated.
4. SO pin connected to GND as long as V_{VCC} stays below minimum value. No signal transferred from primary to secondary-side.
5. V_{IN} potential changes from 0 V to 5 V within 10 ns. Delay is measured from 50% voltage increase on IN pin to 10% voltage increase on GH pin.
6. V_{IN} potential changes from 5 V to 0 V within 10 ns. Delay is measured from 50% voltage decrease on IN pin to 10% voltage decrease on GL pin.
7. Measured from 10% to 90% of V_{GE} (C_G simulates semiconductor gate capacitance). The V_{GE} is measured across C_G .
8. Measured from 90% to 10% of V_{GE} (C_G simulates semiconductor gate capacitance). The V_{GE} is measured across C_G .
9. ASSD function limits G-E voltage of controlled semiconductor in specified time. Conditions: $C_G = 10\text{ nF}$, $V_{TOT} = V_{VISO} = 15\text{ V}$, $V_{VEE} = 0\text{ V}$ (VEE shorted to COM).
10. The amount of time needed to transfer fault event (UVLO or DESAT) from secondary-side to SO pin.
11. The amount of time after primary and secondary-side supply voltages (V_{VCC} and V_{TOT}) reach minimal required level for driver proper operation. No signal is transferred from primary to secondary-side during that time, and no fault condition will be transferred from the secondary-side to the primary-side.
12. Guaranteed by design.
13. Positive current is flowing out of the pin.
14. Safety distances are application dependent and the creepage and clearance requirements should follow specific equipment isolation standards of an application. Board design should ensure that the soldering pads of an IC maintain required safety relevant distances.
15. Measured accordingly to IEC 61000-4-8 ($f_s = 50\text{ Hz}$, and 60 Hz) and IEC 61000-4-9.
16. All pins on each side of the barrier tied together creating a two-terminal device.

Typical Performance Characteristics

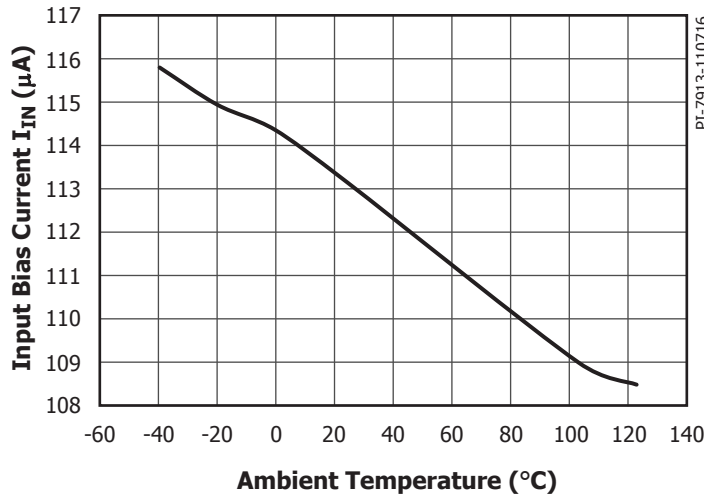

Figure 17. Input Bias Current vs. Ambient Temperature. Conditions: $V_{VCC} = 5\text{ V}$, $V_{IN} = 5\text{ V}$, $V_{TOT} = 25\text{ V}$.

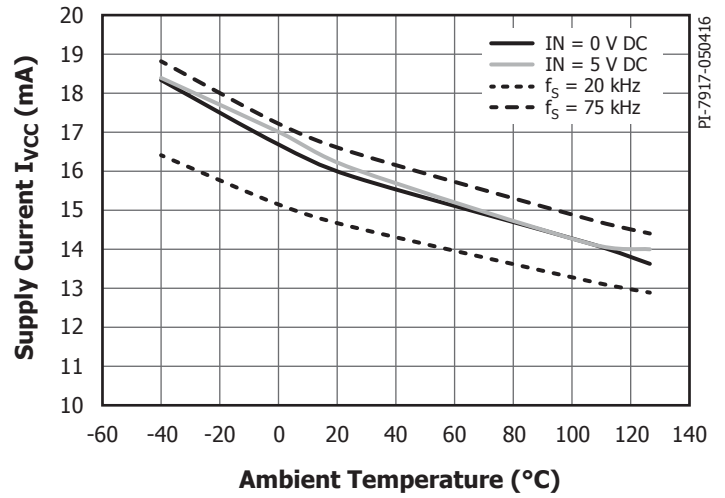

Figure 18. Supply Current Primary-Side I_{VCC} vs. Ambient Temperature. Conditions: $V_{VCC} = 5\text{ V}$, $V_{TOT} = 25\text{ V}$, No-Load.

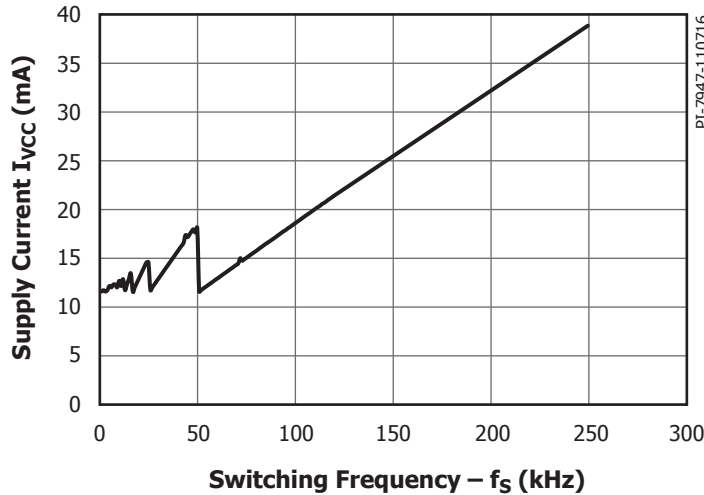

Figure 19. Supply Current Primary-Side I_{VCC} vs. Switching Frequency. Conditions: $V_{VCC} = 5\text{ V}$, $V_{TOT} = 25\text{ V}$, $T_J = 25\text{ }^\circ\text{C}$, $0\text{ Hz} \leq f_S \leq 250\text{ kHz}$, No-Load.

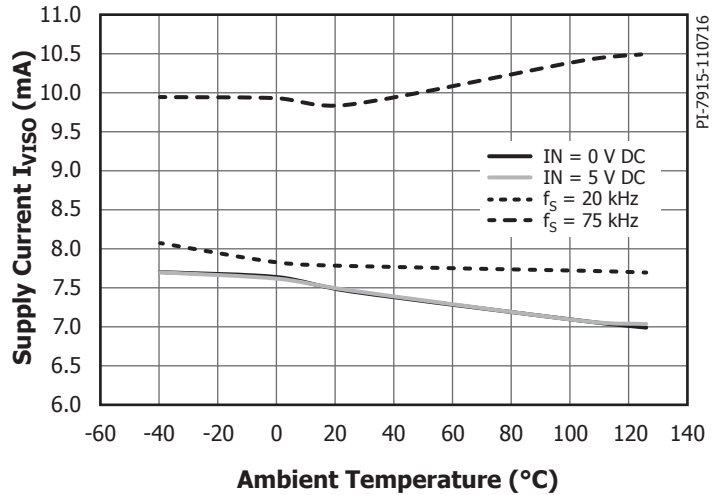

Figure 20. Supply Current Secondary-Side I_{VISO} vs. Ambient Temperature. Conditions: $V_{VCC} = 5\text{ V}$, $V_{TOT} = 25\text{ V}$, No-Load.

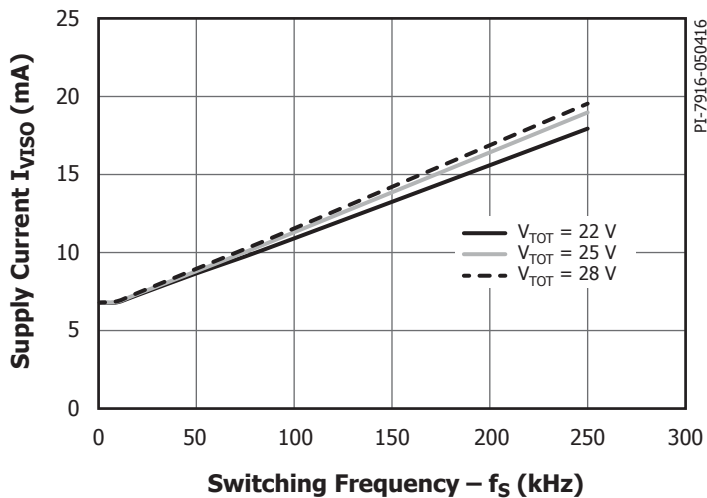

Figure 21. Supply Current Secondary-Side I_{VISO} vs. Ambient Temperature. Conditions: $V_{VCC} = 5\text{ V}$, $V_{TOT} = 25\text{ V}$, No-Load.

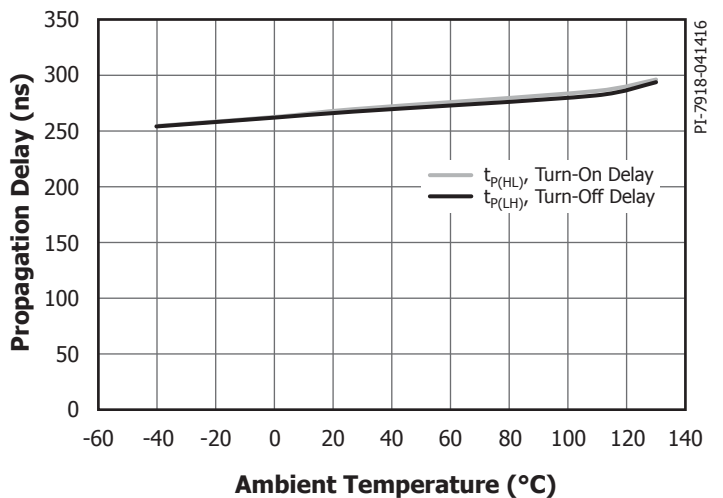

Figure 22. Propagation Delay Time vs. Ambient Temperature. Conditions: $V_{VCC} = 5\text{ V}$, $V_{TOT} = 25\text{ V}$, $f_S = 20\text{ kHz}$, $C_{LOAD} = 2.2\text{ nF}$.

Typical Performance Characteristics

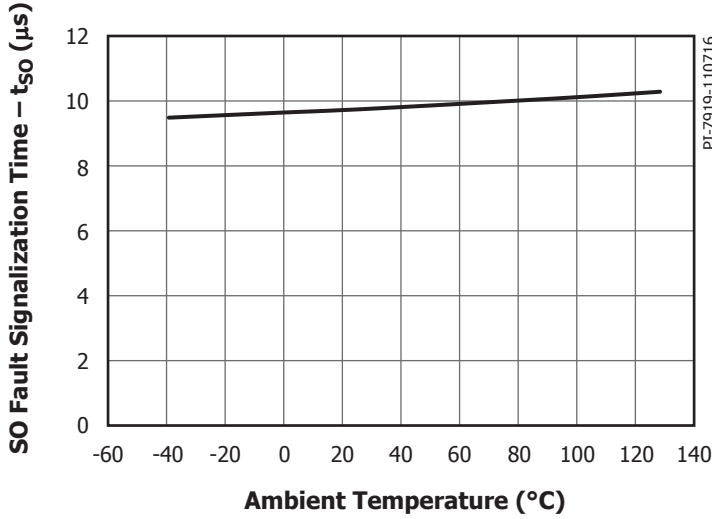

Figure 23. SO Fault Signalization Time vs. Ambient Temperature. Conditions: $V_{CC} = 5\text{ V}$, $V_{TOT} = 25\text{ V}$, $R_{SO} = 4.7\text{ k}\Omega$.

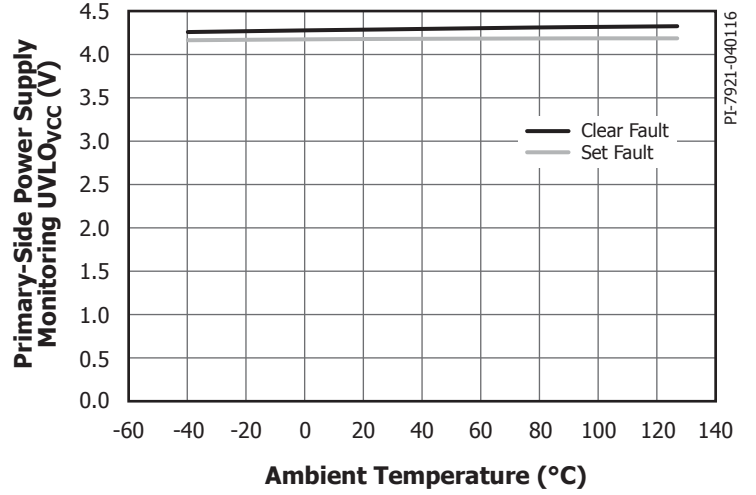

Figure 24. Power Supply Monitoring $UVLO_{VCC}$ vs. Ambient Temperature. Conditions: $V_{TOT} = 25\text{ V}$.

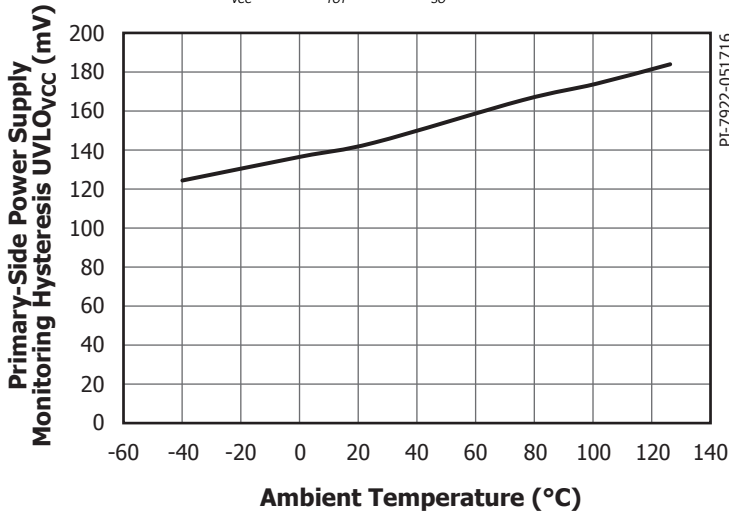

Figure 25. Power Supply Monitoring Hysteresis $UVLO_{VCC}$ vs. Ambient Temperature. Conditions: $V_{TOT} = 25\text{ V}$.

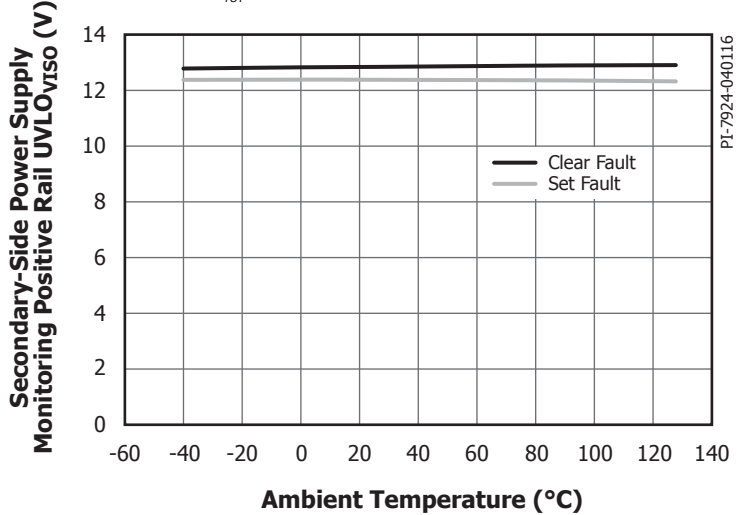

Figure 26. Power Supply Monitoring Positive Rail $UVLO_{VISO}$ vs. Ambient Temperature. Conditions: $V_{CC} = 5\text{ V}$.

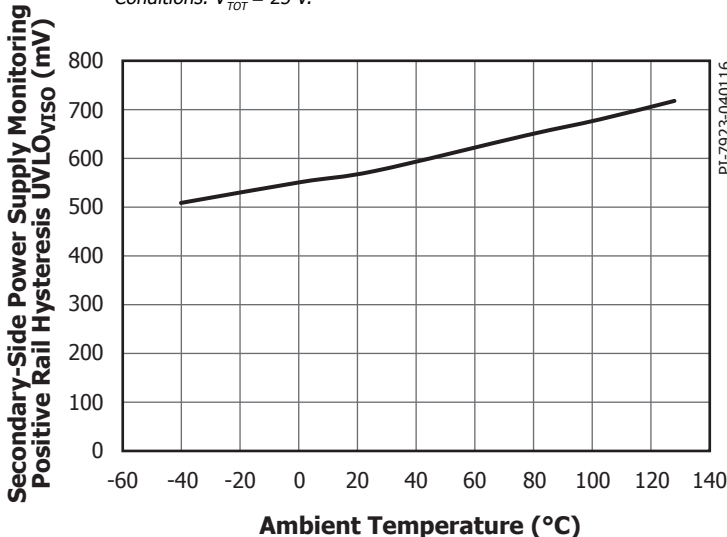

Figure 27. Power Supply Monitoring Positive Rail Hysteresis $UVLO_{VISO}$ vs. Ambient Temperature. Conditions: $V_{CC} = 5\text{ V}$.

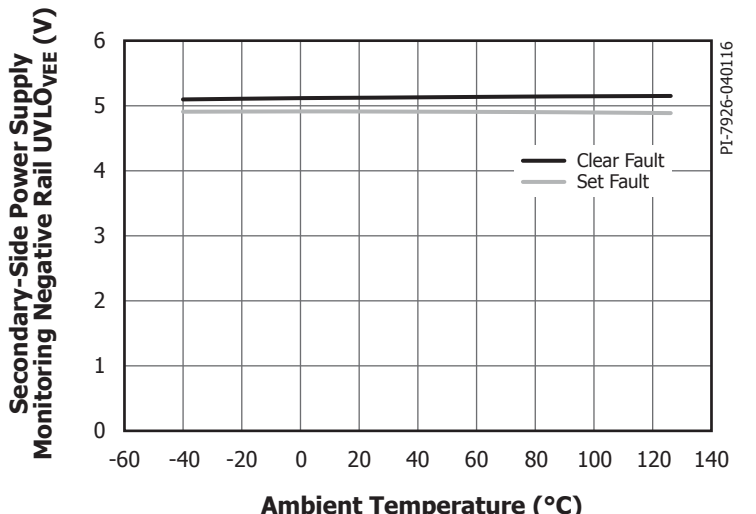

Figure 28. Power Supply Monitoring Negative Rail $UVLO_{VEE}$ vs. Ambient Temperature. Conditions: $V_{CC} = 5\text{ V}$.

Typical Performance Characteristics

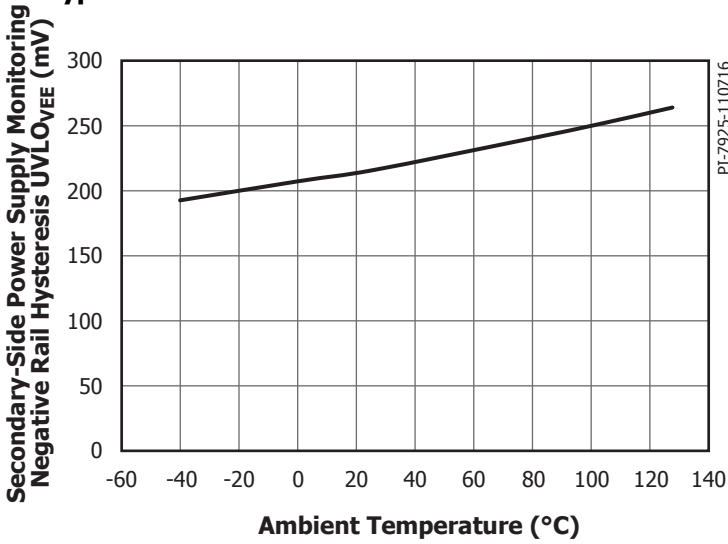

Figure 29. Power Supply Monitoring Negative Rail Hysteresis UVLO_{VEE} vs. Ambient Temperature. Conditions: V_{VCC} = 5 V.

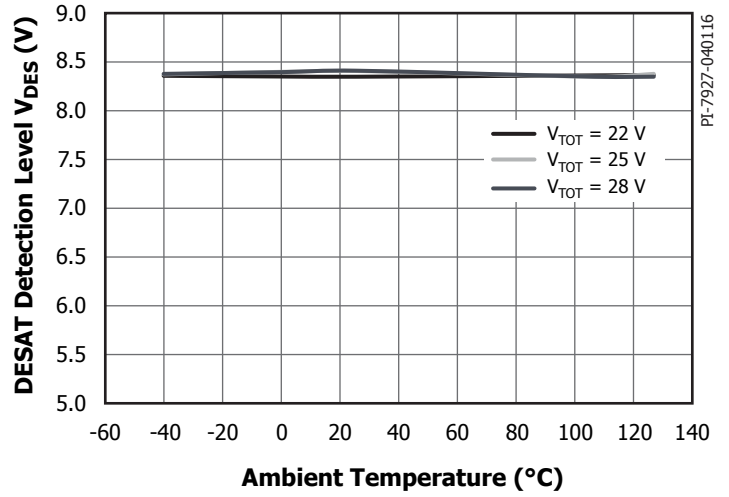

Figure 30. Desaturation Detection Level V_{DES} vs. Ambient Temperature. Conditions: V_{VCC} = 5 V.

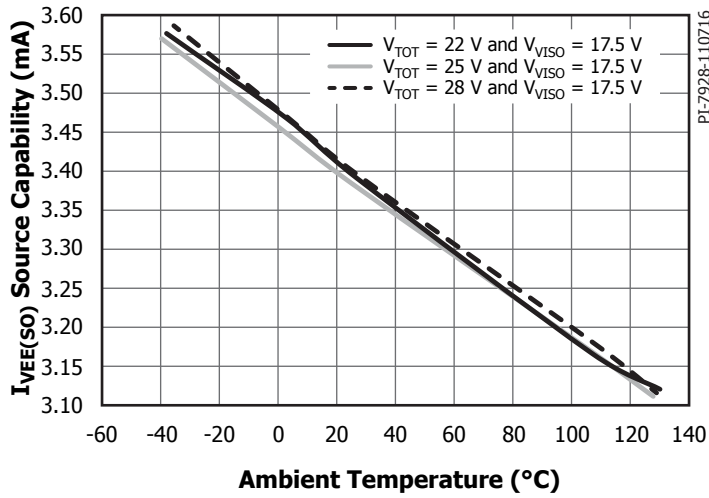

Figure 31. VEE Source Capability I_{VEE(SO)} vs. Ambient Temperature and V_{VISO}. Conditions: V_{VCC} = 5 V, f_s = 20 kHz, Duty Cycle = 50%.

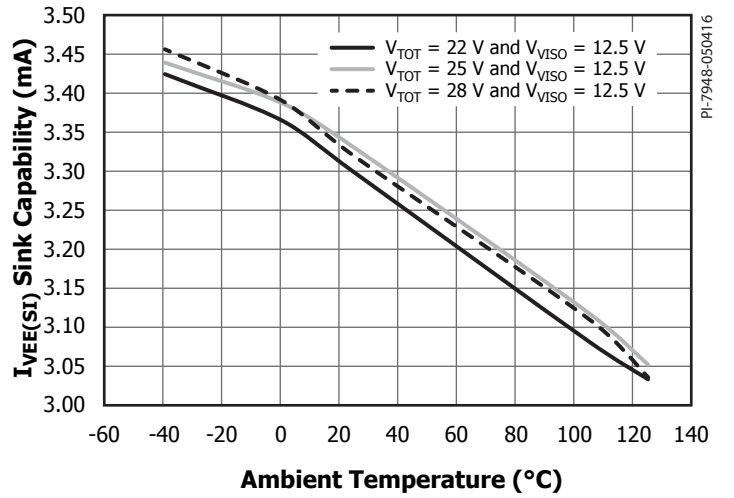
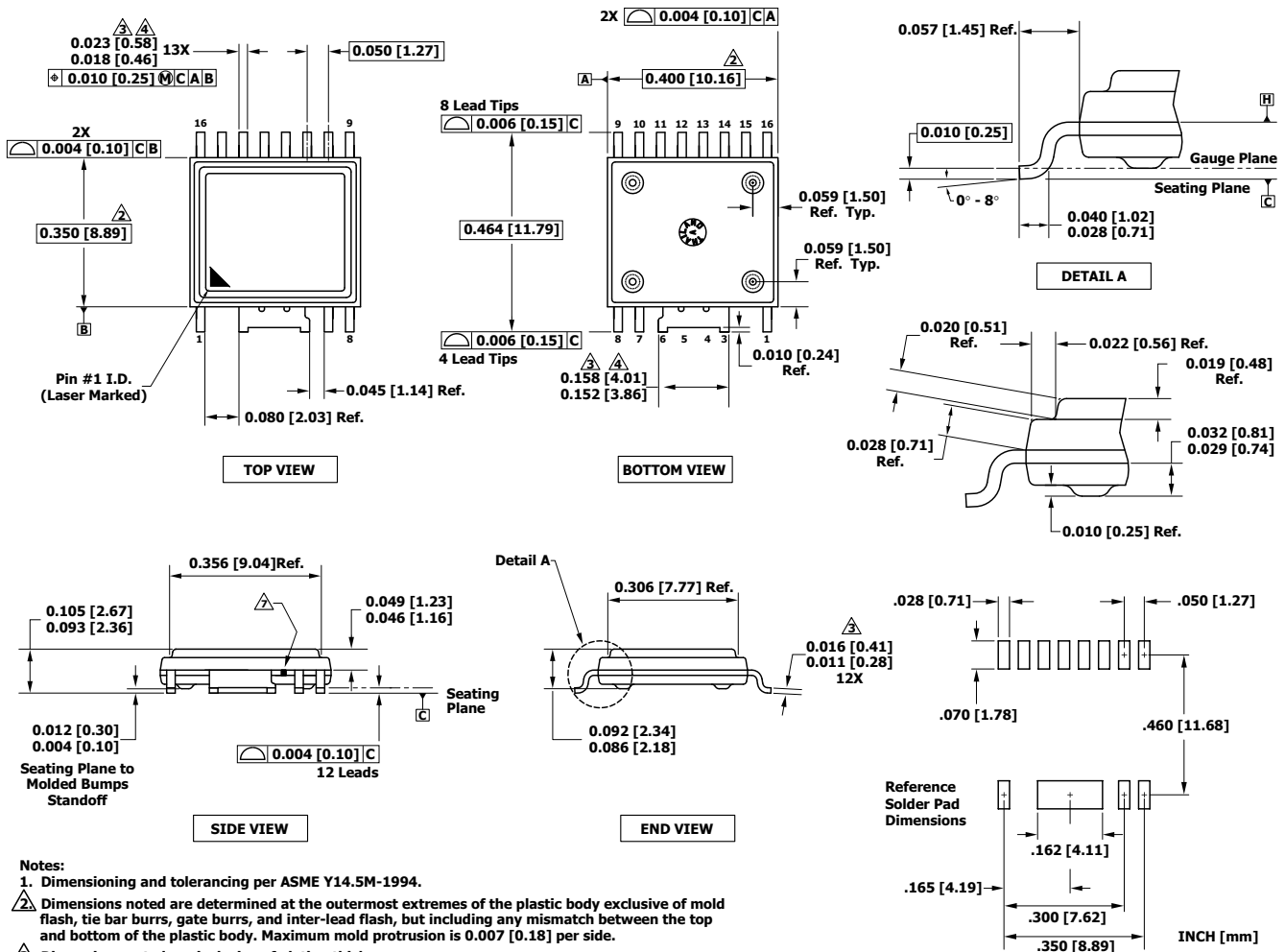

Figure 32. VEE Sink Capability I_{VEE(SI)} vs. Ambient Temperature and V_{VISO}. Conditions: V_{VCC} = 5 V, f_s = 20 kHz, Duty Cycle = 50%.

eSOP-R16B



Notes:

1. Dimensioning and tolerancing per ASME Y14.5M-1994.
2. Dimensions noted are determined at the outermost extremes of the plastic body exclusive of mold flash, tie bar burrs, gate burrs, and inter-lead flash, but including any mismatch between the top and bottom of the plastic body. Maximum mold protrusion is 0.007 [0.18] per side.
3. Dimensions noted are inclusive of plating thickness.
4. Does not include inter-lead flash or protrusions.
5. Controlling dimensions in inches [mm].
6. Datums A and B to be determined in Datum H.
7. Exposed metal at the plastic package body outline/surface between leads 6 and 7, connected internally to wide lead 3/4/5/6.

PI-6995-051716
 POD-eSOP-R16B Rev B

MSL Table

Part Number	MSL Rating
SID11x2K	3

ESD and Latch-Up Table

Test	Conditions	Results
Latch-up at 125 °C	JESD78D	> ±100 mA or > 1.5 × V _{MAX} on all pins
Human Body Model ESD	JESD22-A114F	> ±2000 V on all pins
Charged Device Model ESD	JESD22-C101	> ±500 V on all pins
Machine Model ESD	JESD22-A115C	> ±200 V on all pins

IEC 60664-1 Rating Table

Parameter	Conditions	Specifications
Basic Isolation Group	Material Group	I
Installation Classification	Rated mains voltage ≤ 150 V _{RMS}	I - IV
	Rated mains voltage ≤ 300 V _{RMS}	I - IV
	Rated mains voltage ≤ 600 V _{RMS}	I - IV
	Rated mains voltage ≤ 1000 V _{RMS}	I - III

Electrical Characteristics (EMI) Table

Parameter	Symbol	Conditions	Min	Typ	Max	Units
Common-Mode Transient Immunity, Logic High	CM _H	Typical values measured according to Figures 33, 34. Maximum values are design values assuming trapezoid waveforms		-35 / 50	-100 / 100	kV/μs
Common-Mode Transient Immunity, Logic Low	CM _L	Typical values measured according to Figures 33, 34. Maximum values are design values assuming trapezoid waveforms		-35 / 50	-100 / 100	kV/μs
Variable Magnetic Field Immunity	H _{HPEAK}	See Note 15		1000		A/m
	H _{LPEAK}	See Note 15		1000		

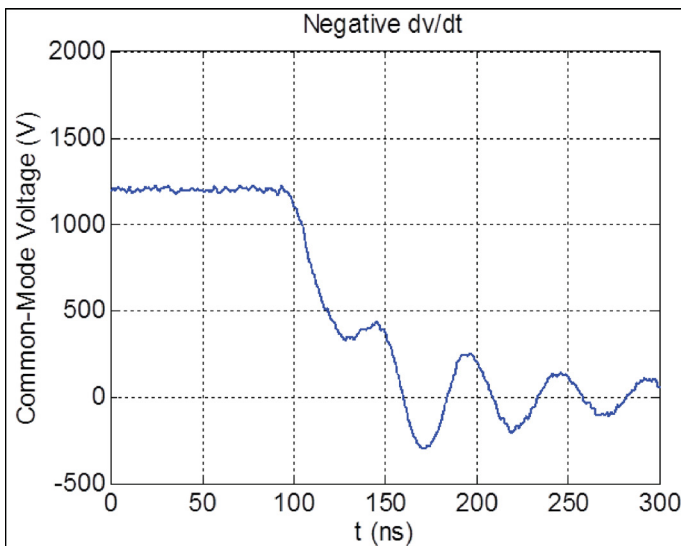

Figure 33. Applied Common Mode Pulses for Generating Negative dv/dt.

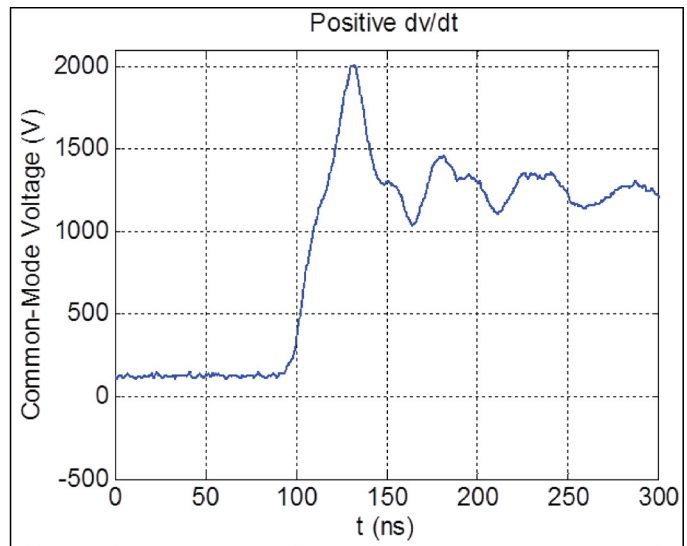
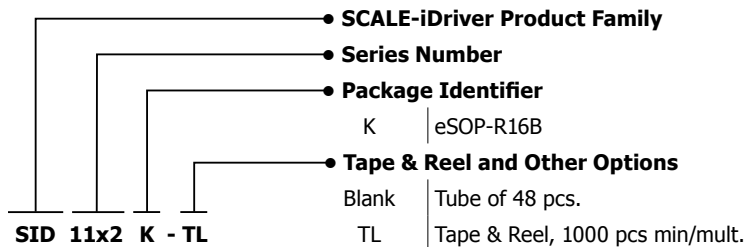

Figure 34. Applied Common Mode Pulses for Generating Positive dv/dt.

Regulatory Information Table

VDE	UL	CSA
Certified to DIN V VDE V 0884-10 (VDE V 0884-10): 2006-12	UR recognized under UL1577 Component Recognition Program	UR recognized to CSA Component Acceptance Notice 5A
Reinforced insulation for Max. Transient Isolation voltage 8 kV _{PEAK} Max. Surge Isolation voltage 8 kV _{PEAK} Max. Repetitive Peak Isolation voltage 1414 V _{PEAK}	Single protection, 5000 V _{RMS} dielectric voltage withstand	Single protection, 5000 V _{RMS} dielectric voltage withstand
File No. 40044363	File E358471	File E358471

Part Ordering Information



Revision	Notes	Date
A	Code S. Initial Release.	05/16
B	Updated Figure 1.	06/16
C	Updated Figures 1, 3, 9, 10, 13 and 14.	08/16
D	Code A. Updated Figure 3, reversed order of Figures 9 and 10, and made text corrections to pages 4, 6 and 7. Updated I_{VCC} , I_{VISO} , t_{R} , t_{F} , t_{FSSD1} , I_{GH} , I_{GL} , $V_{SO(FAULT)}$, $I_{DES(BS)}$ parameters. Moved Electrical Characteristics (EMI) parameter section to page 20 and updated Figure 20.	10/16
E	Made updates to Abs Max Ratings table, added T_C and changed T_{AMB} to T_A under Conditions on page 10. Deleted Typ value from $UVLO_{VISO(BL)}$ on page 11, made changes in Conditions column for $I_{VEE(SO)}$, $I_{VEE(SI)}$, t_{R} and t_{F} on page 12, corrected Max and Units value for t_{START} and $V_{GH(ON)}$ value changes under Conditions on page 13, removed Typ value for DTI, corrected Condition value for R_{IO} and moved Typ values to Max column under Package Insulation Characteristic parameter on page 14. Moved Typ value to Max column for P_S on page 15, added Note 16 and updated Note 1, updated Figure 16 and changed T_{JOP} to T_J on page 16, minor aesthetic updates to Figures 17, 19 20, 23, corrected vertical axis label on Figure 29, updated vertical axis values in Figure 31, updated ESD and Latch-Up table and fixed capitalization in row 2, column 1 of Regulatory Information table.	12/16
F	Added Min value to I_{VCC} parameter on page 11. Added SID1112K part number to family.	11/17
G	Updated with UL approval information for VDE column in Regulatory Information table on page 22.	05/18