

MODEL: SJ-25014A-SMT-TR | **DESCRIPTION:** AUDIO JACK**FEATURES**

- gold flash terminal plating
- low profile design
- reflow solder compatible
- surface mount

**SPECIFICATIONS**

| parameter | conditions/description | min | typ | max | units |
|---------------------------------|--|-----|-------|----------|----------|
| rated input voltage | | | 12 | | Vdc |
| rated input current | | | | 1 | A |
| contact resistance ¹ | between terminal and mating plug between terminal in a closed circuit | | | 50 30 | mΩ mΩ |
| insulation resistance | at 500 Vdc | 100 | | | MΩ |
| voltage withstand | for 1 minute | | | 500 | Vac |
| insertion/withdrawal force | | 0.3 | | 3 | kg |
| operating temperature | | -25 | | 85 | °C |
| life | at a rate of 24 cycles/minute | | 5,000 | | cycles |
| flammability rating | UL94V-0 | | | | |
| RoHS | yes | | | | |

Note: 1. When measured at a current of less than 100 mA/1 kHz
2. All specifications measured at 10~35°C, humidity at 45~85%, under standard atmospheric pressure, unless otherwise noted.

SOLDERABILITY

| parameter | conditions/description | min | typ | max | units |
|--------------------------------|--|-----|-----|-----|-------|
| reel storage | at relative humidity <80% | | | 40 | °C |
| reflow soldering ³ | see reflow profile | 255 | 260 | 265 | °C |
| drying conditions ⁴ | parts in reel: bake at 40°C ±5°C for 72 hours parts removed from reel: bake at 40°C ±5°C for 10 hours | | | | |

Note: 3. It is recommended to reflow solder within 72 hours from opening vacuum packaging at a temperature <30°C & relative humidity <60%.
4. When exceeding floor life by >72 hours.

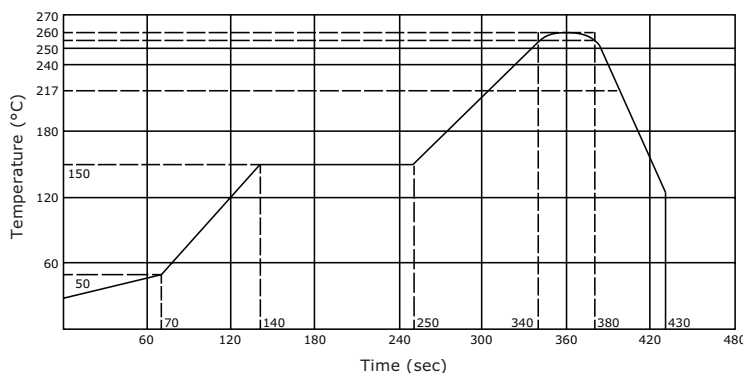

MECHANICAL DRAWING

units: mm
 tolerance:
 X.X ±0.2 mm
 X.XX ±0.10 mm
 X.XXX ±0.050 mm
 PCB: ±0.05 mm

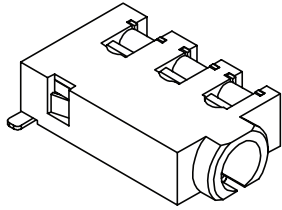

| | MATERIAL | PLATING |
|------------|--------------|------------|
| terminal 1 | copper alloy | gold flash |
| terminal 2 | copper alloy | gold flash |
| terminal 3 | copper alloy | gold flash |
| terminal 4 | copper alloy | gold flash |
| plastic | PA10T | |

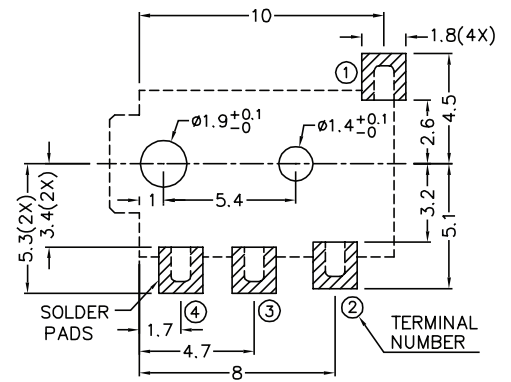
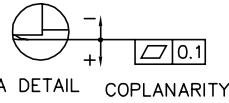
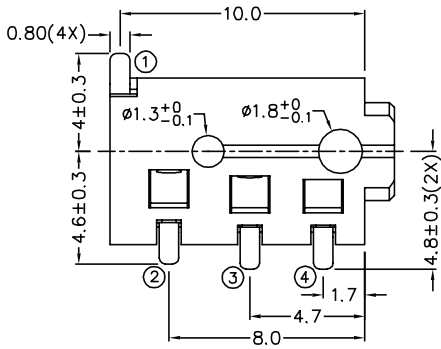
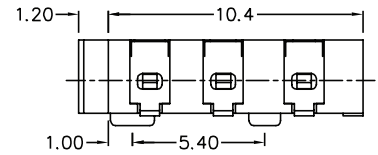
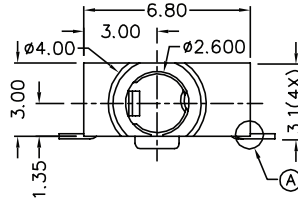
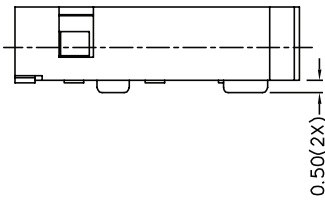

Recommended PCB Layout
Top View

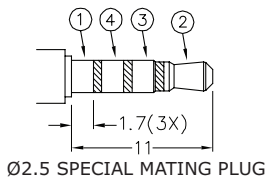

| | |
|-----------|------------------|
| Model No. | SJ-25014A-SMT-TR |
| Schematic | |
| PIN | |
| 1 | sleeve |
| 2 | tip |
| 3 | ring 1 |
| 4 | ring 2 |

PACKAGING

units: mm

Reel Size: $\varnothing 330$ mm

Reel QTY: 1,000 pcs per reel

