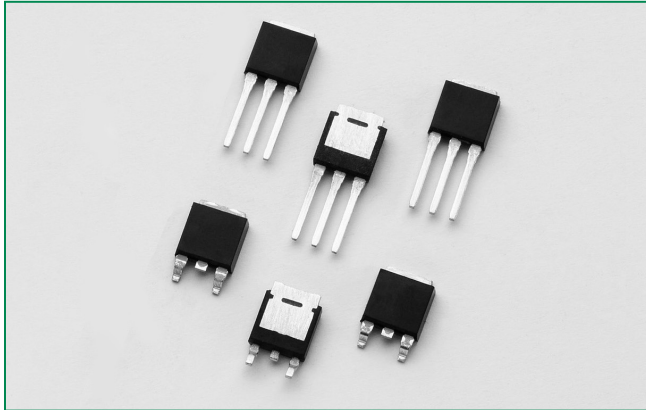


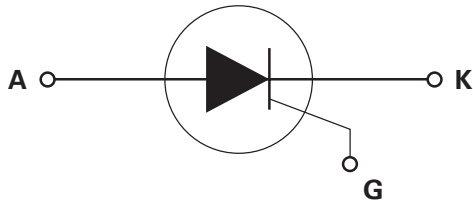
**SJxx06xSx & SJxx06xx Series**



**Main Features**

| Symbol            | Value      | Unit |
|-------------------|------------|------|
| $I_{T(RMS)}$      | 6          | A    |
| $V_{DRM}/V_{RRM}$ | 400 or 600 | V    |
| $I_{GT}$          | 0.2 to 15  | mA   |

**Schematic Symbol**



**Description**

This SJxx06xx high temperature SCR series is ideal for uni-directional switch applications such as phase control, heating, motor speed controls, converters/rectifiers and capacitive discharge ignitions.

These SCRs have a low gate current trigger level of 6mA or 15mA maximum at approximately 1.5V, with a sensitive version of this series having a gate trigger current less than 200µA.

**Features & Benefits**

- Voltage capability up to 600V
- Surge capability up to 100A at 60Hz half cycle
- 150°C maximum junction temperature
- Halogen free and RoHS compliant

**Applications**

Typical applications includes capacitive discharge system for motorcycle engine CDI, portable generator engine ignition, strobe lights and nailers, as well as generic rectifiers, battery voltage regulators and converters. Also controls for power tools, home/brown goods and white goods appliances.

### Absolute Maximum Ratings — Sensitive SCRs

| Symbol            | Parameter                                 | Test Conditions  | Value                   | Unit                   |
|-------------------|---|--|-------------------------|------------------------|
| $I_{T(RMS)}$      | RMS on-state current                      | $T_C = 120^\circ\text{C}$  | 6                       | A                      |
| $I_{T(AV)}$       | Average on-state current                  | $T_C = 120^\circ\text{C}$  | 3.84                    | A                      |
| $I_{TSM}$         | Peak non-repetitive surge current         | single half cycle; $f = 50\text{Hz}$ ;<br>$T_J$ (initial) = $25^\circ\text{C}$ | 83                      | A                      |
|                   |   | single half cycle; $f = 60\text{Hz}$ ;<br>$T_J$ (initial) = $25^\circ\text{C}$ | 100                     |                        |
| $I^2t$            | $I^2t$ Value for fusing                   | $t_p = 8.3\text{ms}$   | 41                      | $\text{A}^2\text{s}$   |
| $di/dt$           | Critical rate of rise of on-state current | $f = 60\text{Hz}, T_J = 150^\circ\text{C}$                                     | 70                      | $\text{A}/\mu\text{s}$ |
| $I_{GM}$          | Peak gate current                         | $P_w = 20\mu\text{s}, T_J = 150^\circ\text{C}$                                 | 0.5                     | A                      |
| $P_{G(AV)}$       | Average gate power dissipation            | $T_J = 150^\circ\text{C}$  | 0.1                     | W                      |
| $T_{stg}$         | Storage temperature range                 |  | -40 to 150              | $^\circ\text{C}$       |
| $T_J$             | Operating junction temperature range      |  | -40 to 150              | $^\circ\text{C}$       |
| $V_{DSM}/V_{RSM}$ | Peak non-repetitive blocking voltage      | $P_w = 100\mu\text{s}$   | $V_{DRM}/V_{RRM} + 100$ | V                      |

### Absolute Maximum Ratings — Standard SCRs

| Symbol            | Parameter                                 | Test Conditions  | Value                   | Unit                   |
|-------------------|---|--|-------------------------|------------------------|
| $I_{T(RMS)}$      | RMS on-state current                      | $T_C = 125^\circ\text{C}$  | 6                       | A                      |
| $I_{T(AV)}$       | Average on-state current                  | $T_C = 125^\circ\text{C}$  | 3.84                    | A                      |
| $I_{TSM}$         | Peak non-repetitive surge current         | single half cycle; $f = 50\text{Hz}$ ;<br>$T_J$ (initial) = $25^\circ\text{C}$ | 83                      | A                      |
|                   |   | single half cycle; $f = 60\text{Hz}$ ;<br>$T_J$ (initial) = $25^\circ\text{C}$ | 100                     |                        |
| $I^2t$            | $I^2t$ Value for fusing                   | $t_p = 8.3\text{ms}$   | 41                      | $\text{A}^2\text{s}$   |
| $di/dt$           | Critical rate-of-rise of on-state current | $f = 60\text{Hz}, T_J = 150^\circ\text{C}$                                     | 100                     | $\text{A}/\mu\text{s}$ |
| $I_{GM}$          | Peak gate current                         | $P_w = 20\mu\text{s}, T_J = 150^\circ\text{C}$                                 | 0.5                     | A                      |
| $P_{G(AV)}$       | Average gate power dissipation            | $T_J = 150^\circ\text{C}$  | 0.1                     | W                      |
| $T_{stg}$         | Storage temperature range                 |  | -40 to 150              | $^\circ\text{C}$       |
| $T_J$             | Operating junction temperature range      |  | -40 to 150              | $^\circ\text{C}$       |
| $V_{DSM}/V_{RSM}$ | Peak non-repetitive blocking voltage      | $P_w = 100\mu\text{s}$   | $V_{DRM}/V_{RRM} + 100$ | V                      |

### Electrical Characteristics ( $T_J = 25^\circ\text{C}$ , unless otherwise specified) — Sensitive SCRs

| Symbol    | Test Conditions   |      | Value     | Unit                   |
|-----------|---|------|-----------|------------------------|
|           |   |      | SJxx06xS2 |                        |
| $I_{GT}$  | $V_D = 6\text{V}, R_L = 100\Omega$  | MIN. | 20        | $\mu\text{A}$          |
|           |   | MAX. | 200       | $\mu\text{A}$          |
| $V_{GT}$  |   | MAX. | 0.8       | V                      |
| $dv/dt$   | $V_D = V_{DRM}; R_{GK} = 220\Omega; T_J = 125^\circ\text{C}$                          | MIN. | 15        | $\text{V}/\mu\text{s}$ |
| $V_{GD}$  | $V_D = V_{DRM}; R_L = 3.3\text{k}\Omega; T_J = 125^\circ\text{C}$                     | MIN. | 0.2       | V                      |
|           | $V_D = V_{DRM}; R_L = 3.3\text{k}\Omega; T_J = 150^\circ\text{C}$                     | MIN. | 0.1       | V                      |
| $V_{GRM}$ | $I_{GR} = 10\mu\text{A}$  | MIN. | 6         | V                      |
| $I_H$     | $I_T = 20\text{mA}$ (initial)   | MAX. | 6         | mA                     |
| $t_q$     | $t_p = 50\mu\text{s}; dv/dt = 5\text{V}/\mu\text{s}; di/dt = -30\text{A}/\mu\text{s}$ | MAX. | 130       | $\mu\text{s}$          |
| $t_{gt}$  | $I_G = 2 \times I_{GT}; P_W = 15\mu\text{s}; I_T = 8\text{A}$                         | TYP. | 6         | $\mu\text{s}$          |

NOTE: xx = voltage

### Electrical Characteristics ( $T_J = 25^\circ\text{C}$ , unless otherwise specified) – Standard SCRs

| Symbol   | Test Conditions   |      | Value    |         | Unit             |
|----------|---|------|----------|---------|------------------|
|          |   |      | SJxx06x1 | SJxx06x |                  |
| $I_{GT}$ | $V_D = 12\text{V}$ $R_L = 60\Omega$   | MAX. | 6        | 15      | mA               |
| $V_{GT}$ |   | MAX. | 1.5      | 1.5     | V                |
| $dv/dt$  | $V_D = V_{DRM}$ ; gate open; $T_J = 125^\circ\text{C}$  | MIN. | 100      | 200     | V/ $\mu\text{s}$ |
|          | $V_D = V_{DRM}$ ; gate open; $T_J = 150^\circ\text{C}$  |      | 50       | 120     |                  |
| $V_{GD}$ | $V_D = V_{DRM}$ ; $R_L = 3.3\text{k}\Omega$ ; $T_J = 125^\circ\text{C}$   | MIN. | 0.2      | 0.2     | V                |
|          | $V_D = V_{DRM}$ ; $R_L = 3.3\text{k}\Omega$ ; $T_J = 150^\circ\text{C}$   | MIN. | 0.1      | 0.1     |                  |
| $I_H$    | $I_T = 200\text{mA}$ (initial)  | MAX. | 20       | 30      | mA               |
| $t_q$    | $I_T = 0.5\text{A}$ ; $t_p = 50\mu\text{s}$ ; $dv/dt = 5\text{V}/\mu\text{s}$ ; $di/dt = -30\text{A}/\mu\text{s}$ | MAX. | 30       | 35      | $\mu\text{s}$    |
| $t_{gt}$ | $I_G = 2 \times I_{GT}$ ; $PW = 15\mu\text{s}$ ; $I_T = 8\text{A}$  | TYP. | 0.5      | 2       | $\mu\text{s}$    |

NOTE: xx = voltage

### Static Characteristics

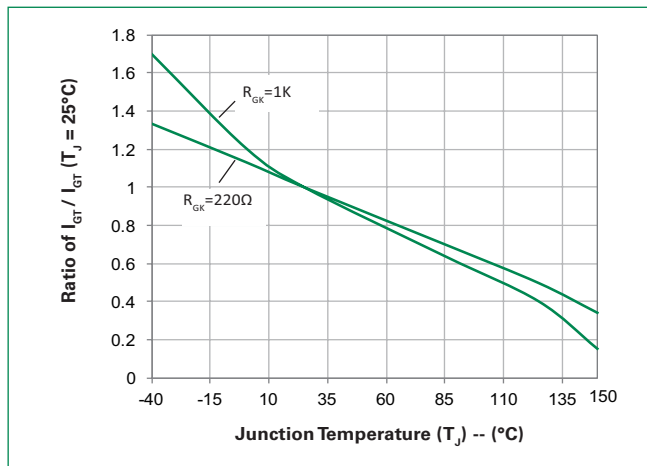
| Symbol              | Test Conditions                             |           |  | Value      | Unit |      |               |
|---------------------|---|-----------|--|------------|------|------|---------------|
| $V_{TM}$            | $I_T = 12\text{A}$ ; $t_p = 380\mu\text{s}$ |           |  | MAX.       | 1.6  | V    |               |
| $I_{DRM} / I_{RRM}$ | @ $V_{DRM} / V_{RRM}$                       | SJxx06xS2 | $T_J = 25^\circ\text{C}$                         | 400 - 600V | MAX. | 5    | $\mu\text{A}$ |
|                     |   |           | $T_J = 125^\circ\text{C}$ , $R_{GK} = 220\Omega$ | 400 - 600V |      | 1000 |               |
|                     |   |           | $T_J = 150^\circ\text{C}$ , $R_{GK} = 220\Omega$ | 400 - 600V |      | 3000 |               |
|                     |   | SJxx06xx  | $T_J = 25^\circ\text{C}$                         | 400 - 600V |      | 10   |               |
|                     |   |           | $T_J = 125^\circ\text{C}$                        | 400 - 600V |      | 1000 |               |
|                     |   |           | $T_J = 150^\circ\text{C}$                        | 400 - 600V |      | 3000 |               |

### Thermal Resistances

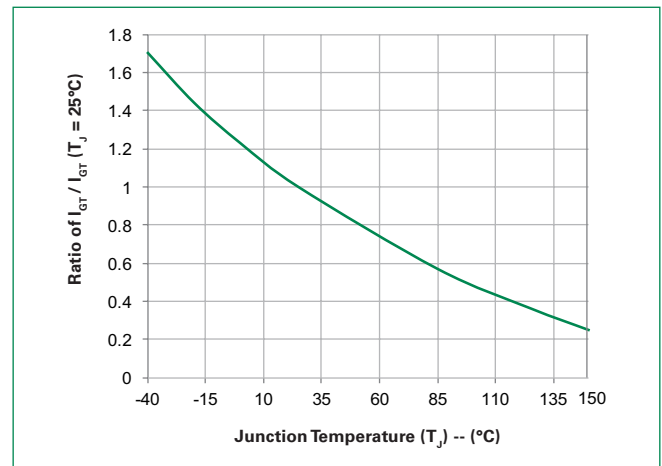
| Symbol            | Parameter             | Value     | Unit |
|-------------------|-----------------------|-----------|------|
| $R_{\theta(J-C)}$ | Junction to case (AC) | SJxx06xS2 | 1.2  |
|                   |                       | SJxx06xx  | 1.2  |

Note: xx = voltage

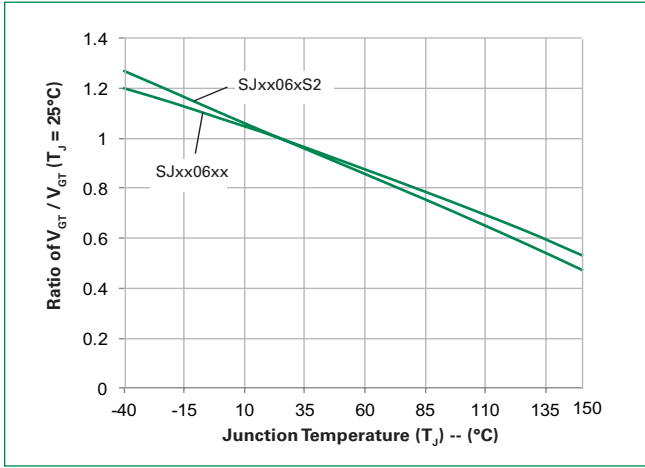
**Figure 1: Normalized DC Gate Trigger Current vs. Junction Temperature (Sensitive SCR)**



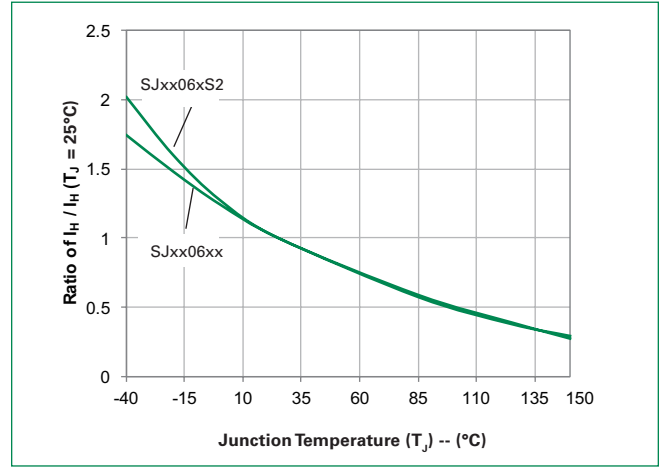
**Figure 2: Normalized DC Gate Trigger Current vs. Junction Temperature (Standard SCR)**



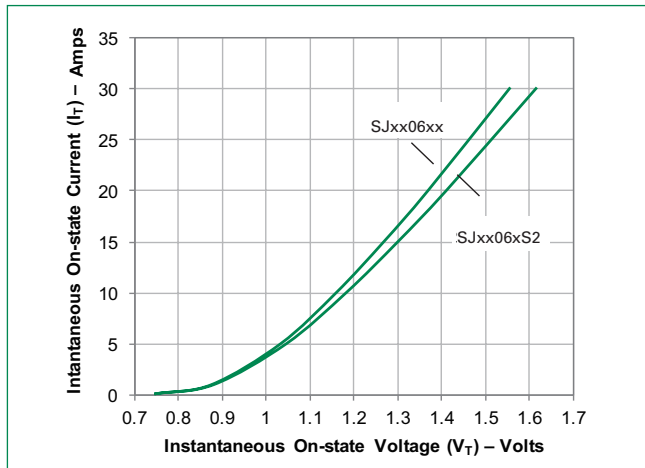
**Figure 3: Normalized DC Gate Trigger Voltage vs. Junction Temperature**



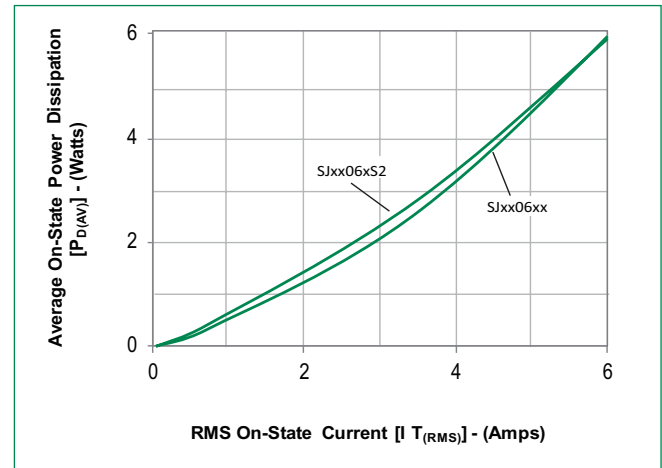
**Figure 4: Normalized DC Holding Current vs. Junction Temperature**



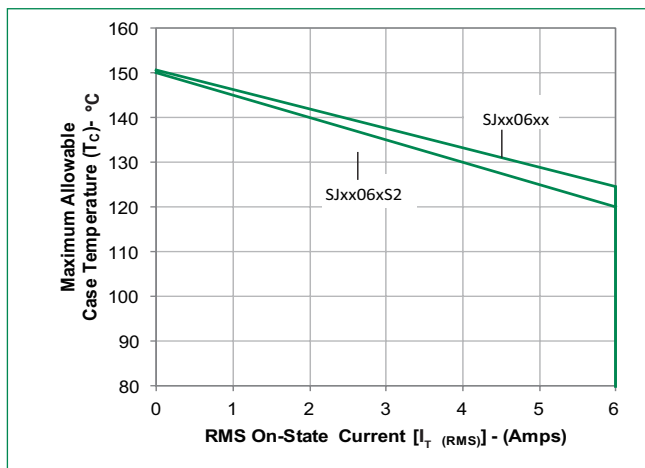
**Figure 5: On-State Current vs. On-State Voltage (Typical)**



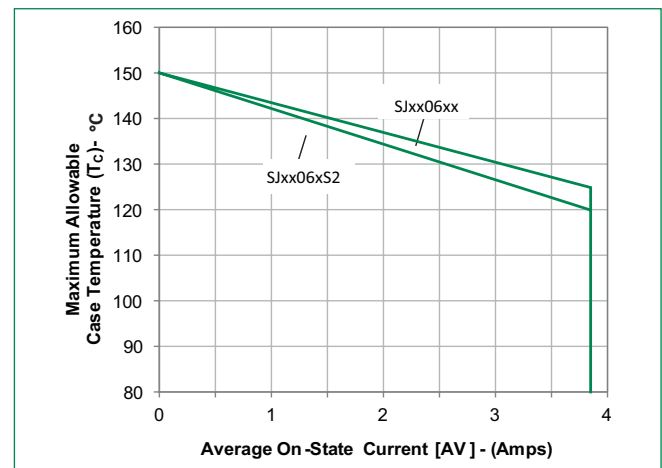
**Figure 6: Power Dissipation (Typical) vs. RMS On-State Current**



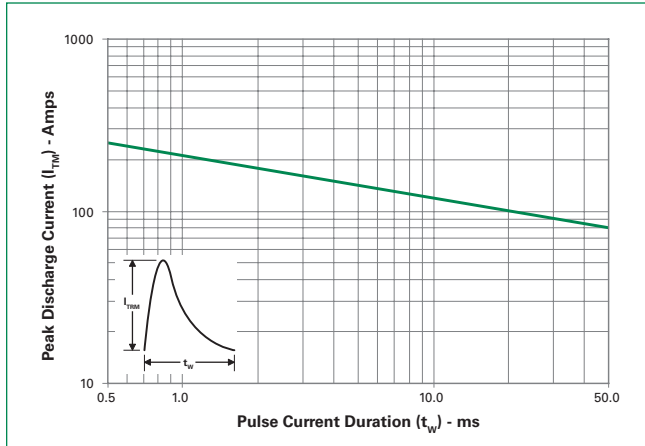
**Figure 7: Maximum Allowable Case Temperature vs. RMS On-State Current**



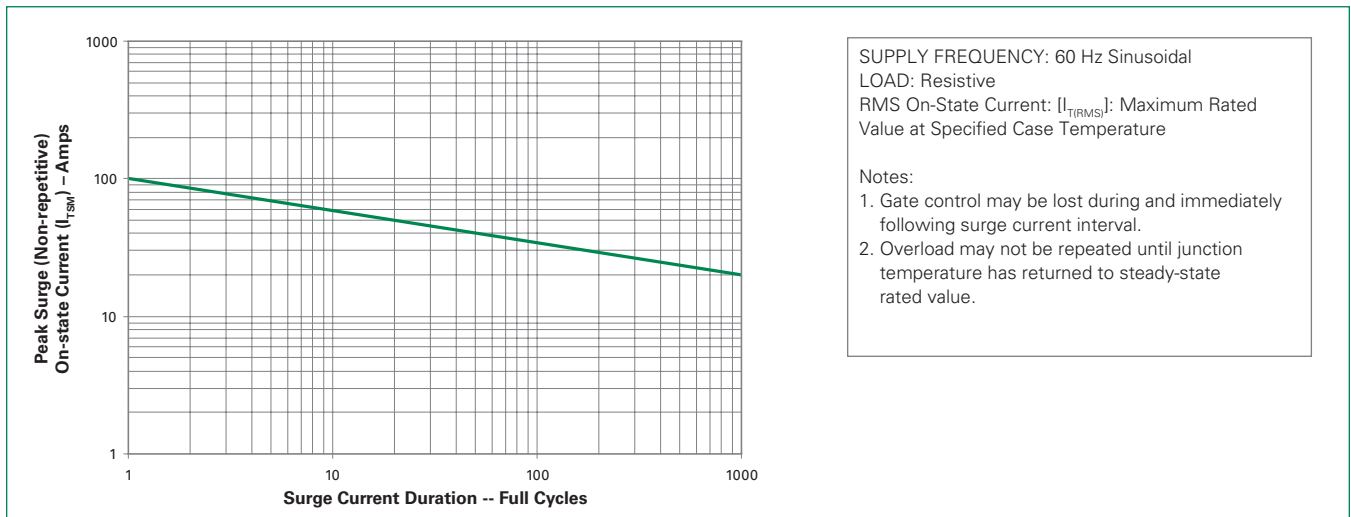
**Figure 8: Maximum Allowable Case Temperature vs. Average On-State Current**



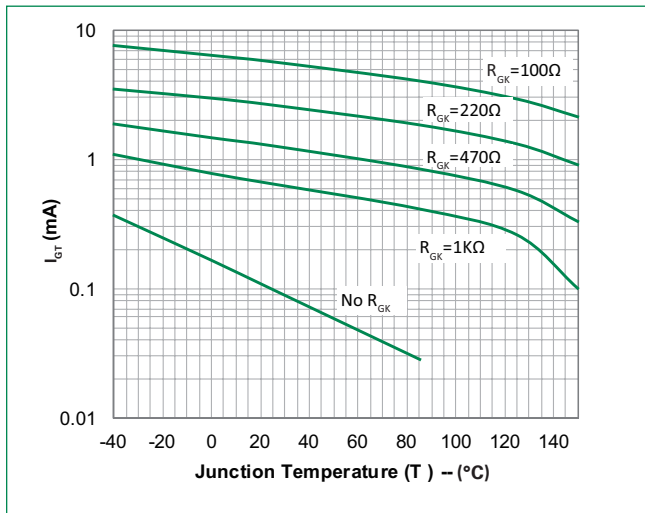
**Figure 9: Peak Capacitor Discharge Current**



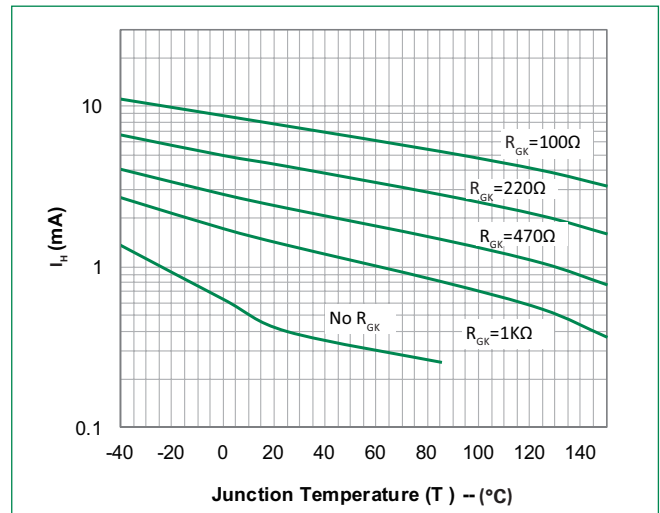
**Figure 10: Surge Peak On-State Current vs. Number of Cycles**



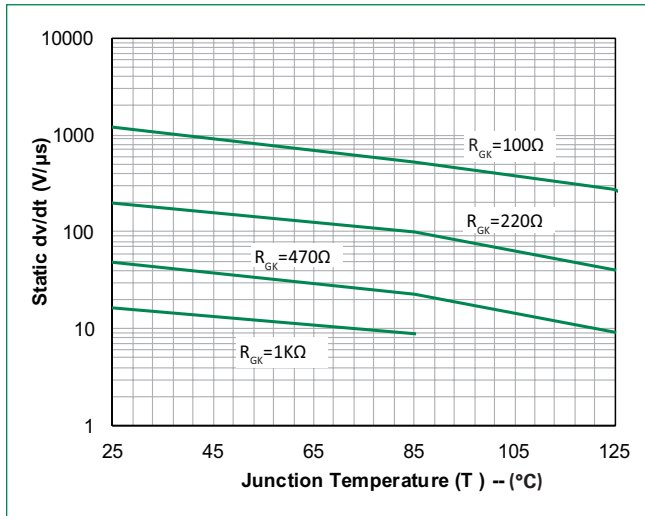
**Figure 11: Typical DC Gate Trigger Current with  $R_{GK}$  vs. Junction Temperature (Sensitive SCR)**



**Figure 12: Typical DC Holding Current with  $R_{GK}$  vs. Junction Temperature (Sensitive SCR)**

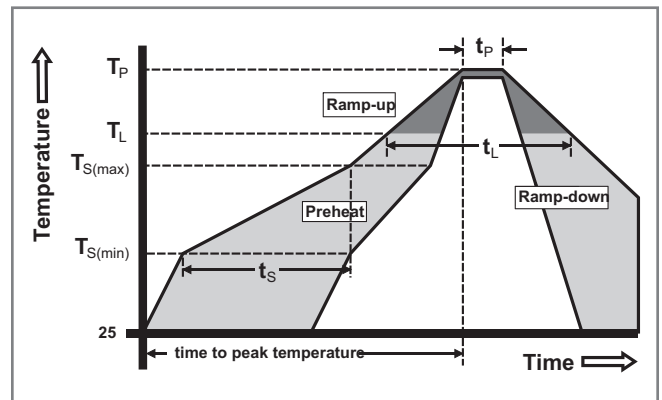


**Figure 13: Typical Static dv/dt with  $R_{GK}$  vs. Junction Temperature (Sensitive SCR)**



**Soldering Parameters**

|  |                                    |                  |
|--|------------------------------------|------------------|
| Reflow Condition                                       | Pb – Free assembly                 |                  |
| Pre Heat   | - Temperature Min ( $T_{s(min)}$ ) | 150°C            |
|  | - Temperature Max ( $T_{s(max)}$ ) | 200°C            |
|  | - Time (min to max) ( $t_s$ )      | 60 – 180 secs    |
| Average ramp up rate (Liquidus Temp) ( $T_L$ ) to peak | 5°C/second max                     |                  |
| $T_{s(max)}$ to $T_L$ - Ramp-up Rate                   | 5°C/second max                     |                  |
| Reflow   | - Temperature ( $T_L$ ) (Liquidus) | 217°C            |
|  | - Time ( $t_L$ )                   | 60 – 150 seconds |
| Peak Temperature ( $T_p$ )                             | 260 <sup>+0/-5</sup> °C            |                  |
| Time within 5°C of actual peak Temperature ( $t_p$ )   | 20 – 40 seconds                    |                  |
| Ramp-down Rate   | 5°C/second max                     |                  |
| Time 25°C to peak Temperature ( $T_p$ )                | 8 minutes Max.                     |                  |
| Do not exceed  | 280°C                              |                  |



### Physical Specifications

|                        |   |
|------------------------|---|
| <b>Terminal Finish</b> | 100% Matte Tin-plated                               |
| <b>Body Material</b>   | UL Recognized epoxy meeting flammability rating V-0 |
| <b>Lead Material</b>   | Copper Alloy  |

### Design Considerations

Careful selection of the correct component for the application's operating parameters and environment will go a long way toward extending the operating life of the Thyristor. Good design practice should limit the maximum continuous current through the main terminals to 75% of the component rating. Other ways to ensure long life for a power discrete semiconductor are proper heat sinking and selection of voltage ratings for worst case conditions. Overheating, overvoltage (including dv/dt), and surge currents are the main killers of semiconductors. Correct mounting, soldering, and forming of the leads also help protect against component damage.

### Environmental Specifications

| Test                              | Specifications and Conditions  |
|-----------------------------------|--|
| <b>AC Blocking</b>                | MIL-STD-750, M-1040, Cond A Applied Peak AC voltage for 1008 hours     |
| <b>Temperature Cycling</b>        | MIL-STD-750, M-1051, 100 cycles; -40°C to +150°C; 15-min dwell-time    |
| <b>Temperature/Humidity</b>       | EIA / JEDEC, JESD22-A101 1008 hours; 160V - DC: 85°C; 85% rel humidity |
| <b>High Temp Storage</b>          | MIL-STD-750, M-1031, 1008 hours; 150°C                                 |
| <b>Low-Temp Storage</b>           | 1008 hours; -40°C  |
| <b>Resistance to Solder Heat</b>  | MIL-STD-750 Method 2031  |
| <b>Solderability</b>              | ANSI/J-STD-002, category 3, Test A                                     |
| <b>Lead Bend</b>                  | MIL-STD-750, M-2036 Cond E   |
| <b>Moisture Sensitivity Level</b> | Level 1, JEDEC-J-STD-020   |

### Product Selector

| Part Number | Voltage |      | Gate Sensitivity | Type          | Package |
|-------------|---------|------|------------------|---------------|---------|
|             | 400V    | 600V |                  |               |         |
| SJxx06VS2   | X       | X    | 0.2mA            | Sensitive SCR | TO-251  |
| SJxx06DS2   | X       | X    | 0.2mA            | Sensitive SCR | TO-252  |
| SJxx06V     | X       | X    | 15mA             | Standard SCR  | TO-251  |
| SJxx06D     | X       | X    | 15mA             | Standard SCR  | TO-252  |
| SJxx06V1    | X       | X    | 6mA              | Standard SCR  | TO-251  |
| SJxx06D1    | X       | X    | 6mA              | Standard SCR  | TO-252  |

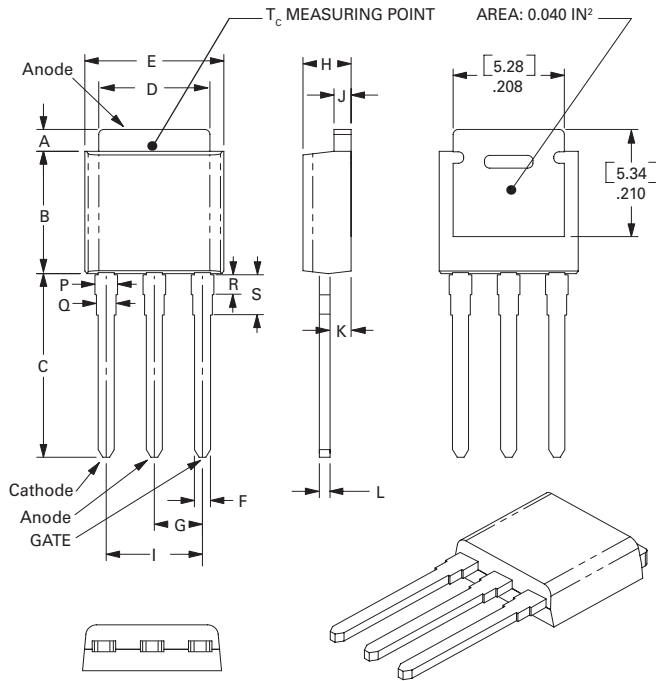
Note: xx = Voltage

### Packing Options

| Part Number | Marking   | Weight | Packing Mode     | Base Quantity     |
|-------------|-----------|--------|------------------|-------------------|
| SJxx06DS2TP | SJxx06DS2 | 0.3 g  | Tube             | 750 (75 per tube) |
| SJxx06DS2RP | SJxx06DS2 | 0.3 g  | Embossed Carrier | 2500              |
| SJxx06VS2TP | SJxx06VS2 | 0.4 g  | Tube             | 750 (75 per tube) |
| SJxx06DTP   | SJxx06D   | 0.3 g  | Tube             | 750 (75 per tube) |
| SJxx06DRP   | SJxx06D   | 0.3 g  | Embossed Carrier | 2500              |
| SJxx06VTP   | SJxx06V   | 0.4 g  | Tube             | 750 (75 per tube) |
| SJxx06D1TP  | SJxx06D1  | 0.3 g  | Tube             | 750 (75 per tube) |
| SJxx06D1RP  | SJxx06D1  | 0.3 g  | Embossed Carrier | 2500              |
| SJxx06V1TP  | SJxx06V1  | 0.4 g  | Tube             | 750 (75 per tube) |

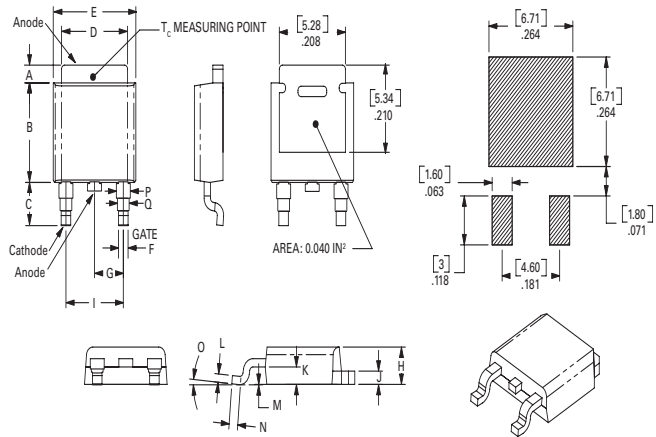
Note: xx = Voltage

### Dimensions — TO-251AA (V/I-Package) — V/I-PAK Through Hole



| Dimension | Inches |       |       | Millimeters |      |      |
|-----------|--------|-------|-------|-------------|------|------|
|           | Min    | Typ   | Max   | Min         | Typ  | Max  |
| A         | 0.037  | 0.040 | 0.043 | 0.94        | 1.01 | 1.09 |
| B         | 0.235  | 0.242 | 0.245 | 5.97        | 6.15 | 6.22 |
| C         | 0.350  | 0.361 | 0.375 | 8.89        | 9.18 | 9.53 |
| D         | 0.205  | 0.208 | 0.213 | 5.21        | 5.29 | 5.41 |
| E         | 0.255  | 0.262 | 0.265 | 6.48        | 6.66 | 6.73 |
| F         | 0.027  | 0.031 | 0.033 | 0.69        | 0.80 | 0.84 |
| G         | 0.087  | 0.090 | 0.093 | 2.21        | 2.28 | 2.36 |
| H         | 0.085  | 0.092 | 0.095 | 2.16        | 2.34 | 2.41 |
| I         | 0.176  | 0.180 | 0.184 | 4.47        | 4.57 | 4.67 |
| J         | 0.018  | 0.020 | 0.023 | 0.46        | 0.51 | 0.58 |
| K         | 0.035  | 0.037 | 0.039 | 0.90        | 0.95 | 1.00 |
| L         | 0.018  | 0.020 | 0.023 | 0.46        | 0.52 | 0.58 |
| P         | 0.042  | 0.047 | 0.052 | 1.06        | 1.20 | 1.32 |
| Q         | 0.034  | 0.039 | 0.044 | 0.86        | 1.00 | 1.11 |
| R         | 0.034  | 0.039 | 0.044 | 0.86        | 1.00 | 1.11 |
| S         | 0.074  | 0.079 | 0.084 | 1.86        | 2.00 | 2.11 |

### Dimensions — TO-252AA (D-Package) — D-PAK Surface Mount



| Dimension | Inches |       |       | Millimeters |      |      |
|-----------|--------|-------|-------|-------------|------|------|
|           | Min    | Typ   | Max   | Min         | Typ  | Max  |
| A         | 0.037  | 0.040 | 0.043 | 0.94        | 1.01 | 1.09 |
| B         | 0.235  | 0.243 | 0.245 | 5.97        | 6.16 | 6.22 |
| C         | 0.106  | 0.108 | 0.113 | 2.69        | 2.74 | 2.87 |
| D         | 0.205  | 0.208 | 0.213 | 5.21        | 5.29 | 5.41 |
| E         | 0.255  | 0.262 | 0.265 | 6.48        | 6.65 | 6.73 |
| F         | 0.027  | 0.031 | 0.033 | 0.69        | 0.80 | 0.84 |
| G         | 0.087  | 0.090 | 0.093 | 2.21        | 2.28 | 2.36 |
| H         | 0.085  | 0.092 | 0.095 | 2.16        | 2.33 | 2.41 |
| I         | 0.176  | 0.179 | 0.184 | 4.47        | 4.55 | 4.67 |
| J         | 0.018  | 0.020 | 0.023 | 0.46        | 0.51 | 0.58 |
| K         | 0.035  | 0.037 | 0.039 | 0.90        | 0.95 | 1.00 |
| L         | 0.018  | 0.020 | 0.023 | 0.46        | 0.51 | 0.58 |
| M         | 0.000  | 0.000 | 0.004 | 0.00        | 0.00 | 0.10 |
| N         | 0.021  | 0.026 | 0.027 | 0.53        | 0.67 | 0.69 |
| O         | 0°     | 0°    | 5°    | 0°          | 0°   | 5°   |
| P         | 0.042  | 0.047 | 0.052 | 1.06        | 1.20 | 1.32 |
| Q         | 0.034  | 0.039 | 0.044 | 0.86        | 1.00 | 1.11 |