

gen4-uLCD-24PT

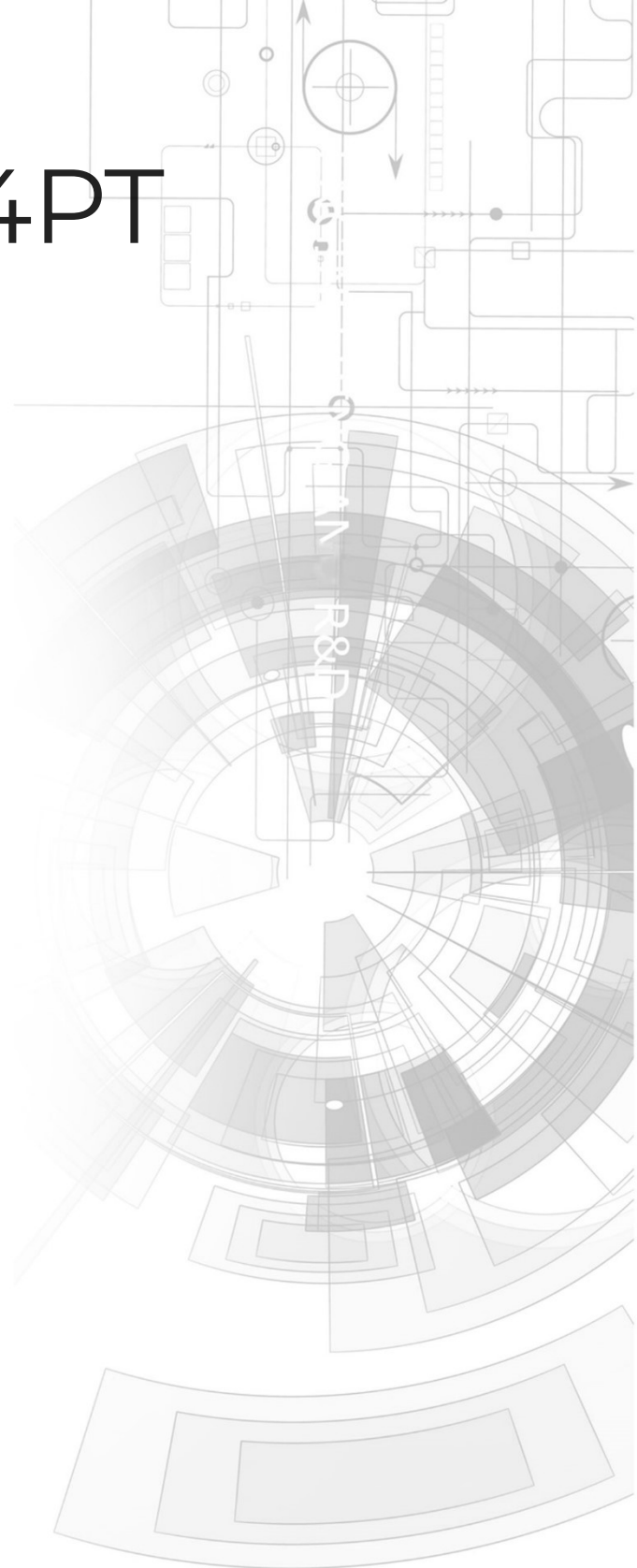

Datasheet

Revision 1.8

Copyright © 2023 4D Systems

Content may change at any time. Please refer to the resource centre for latest documentation.

Contents

1. Description	4
2. Features	5
3. Hardware Overview	6
4. Hardware Interface - Pins	8
4.1. Serial Ports - TTL Level	8
4.2. General Purpose I/O	9
4.3. System Pins	10
4.4. I2C	11
5. Module Features	11
5.1. Picaso Processor	11
5.2. Audio	12
5.3. SD/SDHC Memory Cards	12
5.4. FAT16	13
5.5. Application PCB Support	14
5.6. RF / EMI Shielding Support	15
6. Display/Module Preparations	16
7. Hardware Tools	17
7.1. 4D-UPA Programming Cable/Adaptor	17
8. Programming Language	19
9. Workshop4 IDE	20
9.1. PmmC Programming	21
10. Display Module Part Numbers	23
11. FFC Cable	23
12. Starter Kit	24
13. Mechanical Details	25
14. Schematic Details	26
15. Specifications	27
16. Revision History	31

1. Description

The gen4 2.4" Picaso Integrated Display Module is part of the latest gen4 series of modules Designed and Manufactured by 4D Systems.

The gen4 series was designed specifically for ease of integration and use, with careful consideration for space requirements and functionality.

This specific gen4 module features a 2.4" colour TFT LCD, with resistive touch. It is powered by the well-known 4D Labs Picaso Graphics Processor, which offers an array of functionality and options for any Designer / Integrator / User.

The Picaso processor features include 13 customisable GPIO, 2 Serial ports, and a Master I2C interface.

The 2.4" Picaso Integrated Display Module features a TFT LCD Display and is capable of Touch Detection, microSD memory Storage, GPIO and Communications, along with multiple millisecond resolution timers, and Audio Generation.

The gen4 Series is 100% compatible with the Workshop4 IDE and its 4 different development environments, providing the User with a wealth of options for programming and controlling their system.

Anything designed to run on other 4D Systems displays modules featuring Picaso Graphic Processors can be run on this gen4 Integrated Display Module, with little or no required modifications. Please contact 4D Systems Support Team for assistance if migrating from a previous model.

The gen4 series of Integrated Display Modules features a 30-pin ZIF/FFC/FPC socket, designed for a 30-pin FPC cable, for easy and simple connection to an application or mother board, or for connecting to accessory boards for a range of functionality advancements.

The gen4 series of modules has been designed to minimise the impact of display-related circuitry and provide a platform suitable for integration into a product. Application boards can sit flush on the back of the gen4 if required, as the display-related electronics sit inside the plastic mounting base, leaving the application board surface clear for User circuitry.

2. Features

- Universal 2.4" Intelligent LCD-TFT display module powered by the Picaso Processor.
- 240 x 320 Resolution, RGB 65K true to life colours, TFT Screen with integrated 4-wire Resistive Touch Panel.
- 14KB of Flash memory for User Application Code and Data.
- 14KB of SRAM for user variables, or 14KB shared user code and program variables.
- 2 x Asynchronous hardware serial ports (COM0, COM1), TTL interface, with 300 to 600K baud.
- 1 x I²C interface (Master).
- 8 x 16-bit timers with 1 millisecond resolution.
- 13 x General Purpose I/O pins. Supports fast 8-bit parallel data transfer through Upper 8 bits.
- 30pin FPC connection, for all signals, power, communication, GPIO and programming.
- On-board latch type micro-SD memory card connected for multimedia storage and data logging purposes.
- DOS-compatible file access (FAT16 format) as well as low-level access to card memory.
- Built-in extensive 4DGL graphics and system library functions.
- Display full colour images, animations, icons and video clips.
- Supports all available Windows fonts.
- 4.0V to 5.5V range operation (single supply).
- Module dimensions: 78.4 x 44.8 x 7.2mm
- Weighing ~ 21 g
- Display Viewing Area: 48.96 x 36.72mm.
- 4x mounting tabs with 3.2mm holes for mechanical mounting using M3 screws.
- RoHS and REACH compliant.
- CE Compliant - please ask for CE declarations from our Support Team.

3. Hardware Overview

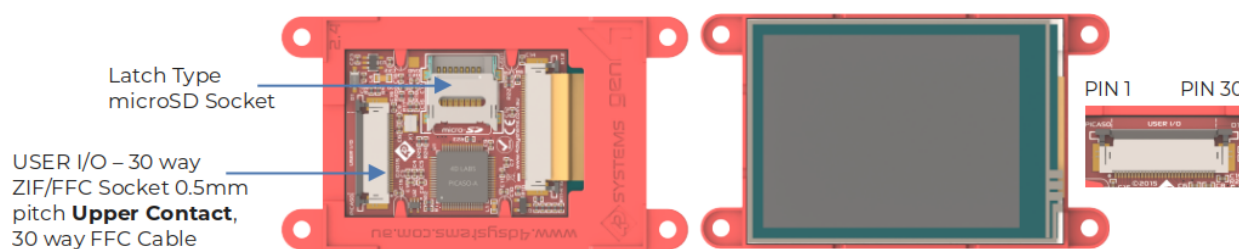

FPC Pinout

Pin	Symbol	I/O	Description
1	GND	P	Supply Ground
2	IO1	I/O	General Purpose Input/Output, 3.3V Level - 5VTolerant
3	IO2	I/O	General Purpose Input/Output, 3.3V Level - 5VTolerant
4	IO3	I/O	General Purpose Input/Output, 3.3V Level - 5VTolerant
5	IO4	I/O	General Purpose Input/Output, 3.3V Level - 5VTolerant. Also used for Bus Read.
6	BUS5	I/O	General Purpose Input/Output, 3.3V Level - 5VTolerant
7	BUS4	I/O	General Purpose Input/Output, 3.3V Level - 5VTolerant
8	BUS3	I/O	General Purpose Input/Output, 3.3V Level - 5VTolerant
9	BUS2	I/O	General Purpose Input/Output, 3.3V Level - 5VTolerant
10	BUS1	I/O	General Purpose Input/Output, 3.3V Level - 5VTolerant
11	BUS0	I/O	General Purpose Input/Output, 3.3V Level - 5VTolerant
12	BUS6	I/O	General Purpose Input/Output, 3.3V Level - 5VTolerant
13	BUS7	I/O	General Purpose Input/Output, 3.3V Level - 5VTolerant
14	IO5	I/O	General Purpose Input/Output, 3.3V Level - 5VTolerant. Also Bus Write.
15	RX1	I	Asynchronous Serial Receive COM1, TTL level. Connect this pin to the Transmit (TX) signal of other serial devices. Used in conjunction with the TX1 pin. This pin is tolerant up to 5.0V levels.
16	TX1	O	Asynchronous Serial Transmit COM1, TTL level. Connect this pin to the Receive (RX) signal of other serial devices. Used in conjunction with the RX1 pin. This pin has a 3.3V Level output.
17	I2C SCL	O	I2C Interface, SCL pin.
18	I2C SDA	I/O	I2C Interface, SDA pin.

Pin	Symbol	I/O	Description
19	AUDIO_OUT	O	Audio Output, PWM, to feed into external amplifier via filter network.
20	AUDENB	O	Audio Amplifier Enable, to enable/disable external amplifier.
21	GND	P	Supply Ground
22	RESET	I	Master Reset signal. Internally pulled up to 3.3V via a 10K resistor. An active Low pulse greater than 2 micro-seconds will reset the module. If the module needs to be reset externally, only use open collector type circuits. This pin is not driven low by any internal conditions. The host should control this pin via one of its port pins using an open collector/drain arrangement.
23	RX0	I	Asynchronous Serial Receive COM0, TTL level. Connect this pin to the Transmit (TX) signal of other serial devices. Used in conjunction with the TX0 pin for programming this module. This pin is tolerant up to 5.0V levels.
24	TX0	O	Asynchronous Serial Transmit COM0, TTL level. Connect this pin to the Receive (RX) signal of other serial devices. Used in conjunction with the RX0 pin for programming this module. This pin has a 3.3V Level output.
25	GND	P	Supply Ground
26	5V IN	P	Main Voltage Supply +ve input pin. Reverse polarity protected. The range is 4.0V to 5.5V, nominal 5.0V.
27	5V IN	P	Main Voltage Supply +ve input pin. Reverse polarity protected. The range is 4.0V to 5.5V, nominal 5.0V.
28	NC	-	Not Connected
29	NC	-	Not Connected
30	GND	P	Supply Ground

 **Note**

I = Input, **O** = Output, **P** = Power

4. Hardware Interface - Pins

This section describes in detail the hardware interface pins of the device.

4.1. Serial Ports - TTL Level

The Picaso Processor has two dedicated hardware Asynchronous Serial ports that can communicate with external serial devices. These are referred to as the COM0 and the COM1 serial ports.

The primary features are:

- Full-Duplex 8-bit data transmission and reception.
- Data format: 8 bits, No Parity, 1 Stop bit.
- Independent Baud rates from 300 baud up to 600K baud.
- Single byte transmits and receives a fully buffered service. The buffered service feature runs in the background capturing and buffering serial data without the user application having to constantly poll any of the serial ports. This frees up the application to service other tasks.

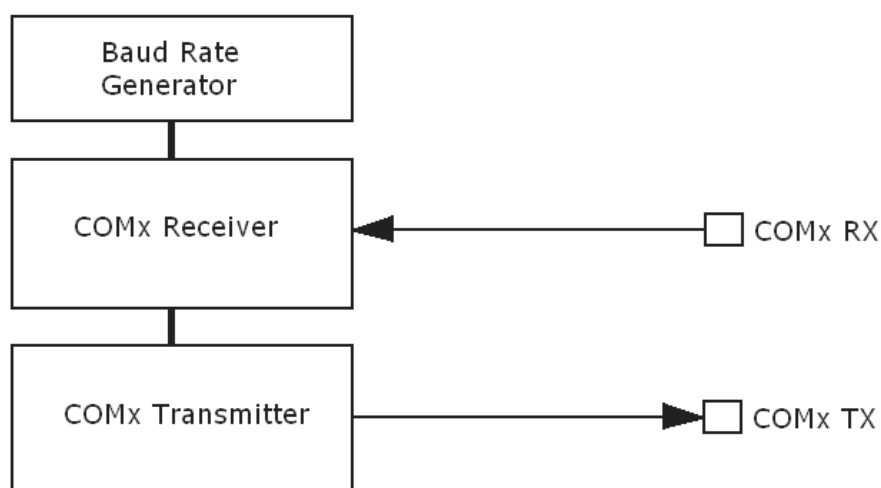

A single-byte serial transmission consists of the start bit, 8 bits of data followed by the stop bit. The start bit is always 0, while a stop bit is always 1. The LSB (Least Significant Bit, Bit 0) is sent out first following the start bit. The figure below shows a single-byte transmission timing diagram.

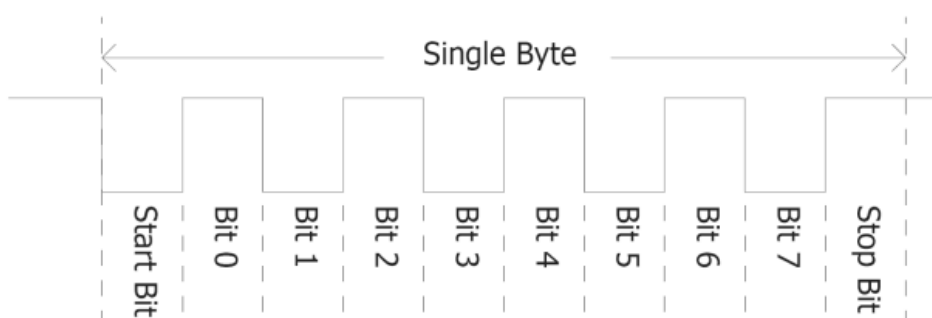

COM0 is also the primary interface for 4DGL user program downloads and chip configuration (PmmC programming). Once the compiled 4DGL application program (EVE byte-code) is downloaded and the user code starts executing, the serial port is then available to the user application. Refer to the [PmmC Programming](#) section for more details on this subject.

TX0 pin (Serial Transmit COM0):

Asynchronous Serial port COM0 transmit pin, TX0. Connect this pin to the external serial device receive (Rx) signal. This pin outputs at a 3.3V Level.

RX0 pin (Serial Receive COM0):

Asynchronous Serial port COM0 receive pin, RX0. Connect this pin to an external serial device transmit (Tx) signal. This pin is native 3.3V level, but 5.0V tolerant.

TX1 pin (Serial Transmit COM1):

Asynchronous Serial port COM1 transmit pin, TX1. Connect this pin to the external serial device receive (Rx) signal. This pin outputs at a 3.3V Level.

RX1 pin (Serial Receive COM1):

Asynchronous Serial port COM1 receive pin, RX1. Connect this pin to an external serial device transmit (Tx) signal. This pin is native 3.3V level, but 5.0V tolerant.

Serial ports output at the level of TTL 3.3V, but, they are 5V tolerant, so they can accept communications from 5V devices.

Please refer to the [Picaso Internal Functions Manual](#) for more information.

4.2. General Purpose I/O

There are 13 general purpose Input/Output (GPIO) pins available to the user. These are grouped as IO1 -> IO5 and BUS0 -> BUS7. Power-Up Reset default is all INPUTS.

The 5 I/O pins (IO1 -> IO5), provide flexibility for individual bit operations while the 8 pins (BUS0 -> BUS7), known as GPIO BUS, serve collectively for byte-wise operations. The IO4 and IO5 also act as strobing signals to control the GPIO Bus. GPIO Bus can be read or written by strobing a low pulse (50ns duration or greater) the IO4/BUS_RD or IO5/BUS_WR for read or write respectively.

Please refer to the [Picaso Internal Functions Manual](#) for detailed information.

IO1-IO5 pins:

General purpose I/O pins. Each pin can be individually set for INPUT or an OUTPUT. Power-Up Reset default is all INPUTS. Digital GPIO can source/sink 4mA.

For more information see the [Specifications](#) section of this datasheet.

IO4/BUS_RD pin (GPIO IO4 or BUS_RD pin):

General Purpose IO4 pin. Also used for BUS_RD signal to read and latch the data into the parallel GPIO BUS0..BUS7.

IO5/BUS_WR pin (GPIO IO5 or BUS_WR pin):

General Purpose IO5 pin. Also used for BUS_WR signal to write and latch the data to the parallel GPIO BUS0..BUS7.

BUS0-BUS7 pins (GPIO 8-Bit Bus):

8-bit parallel General purpose I/O Bus.

 **Note**

GPIO pins are 5.0V tolerant. All pins output at 3.3V levels.

4.3. System Pins

+5V IN (Module Voltage Input):

Module supply voltage input pins. Both of these pins should be connected to a stable supply voltage in the range of 4.0 Volts to 5.5 Volts DC. The nominal operating voltage is 5.0 Volts. Note backlight brightness will be lower for voltages under 5.0V.

GND (Module Ground):

Device ground pins. At least two pins should be connected to the ground.

RESET (Module Master Reset):

Module Master Reset pin. An active low pulse of greater than 2 μ s will reset the module. Internally pulled up to 3.3V via a 10K resistor. Only use open collector-type circuits to reset the device if an external reset is required.

AUDENB (Audio Enable Output):

Output dedicated to enabling or disabling an external amplifier, where required.

AUDIO (PWM Audio Output):

Output specifically for Audio. This pin is a PWM output from the Picaso Processor. This pin is a 3.3V level PWM output to drive an external amplifier with Picaso-generated Audio, via an external filtering circuit to turn digital PWM into Analog. Note that AUDENB must be enabled in Picaso for any input signal to be heard.

4.4. I2C

There is one I²C Master Channel on the Picaso processor. The I²C channel is Master only, and cannot be configured to be a slave at this time.

To setup the I²C Channel the following 4DGL function is used:

- **I2C_Open(Speed)**

where :

'Speed' is the desired I2C Bus speed.

There are then an array of functions, typical of any I2C capable processor, such as Close, Start, Stop, Restart, Read, Write, Ack, Nack, etc.

Please refer to the [Picaso Internal Functions Manual](#) for more information on how to use the I²C functions, along with the [Picaso-Processor](#) datasheet.

5. Module Features

The gen4 series of Integrated Display Modules are designed to accommodate most applications. Some of the main features of the module are listed below.

5.1. Picaso Processor

The module is designed around the Picaso Graphics Controller from 4D-Labs.

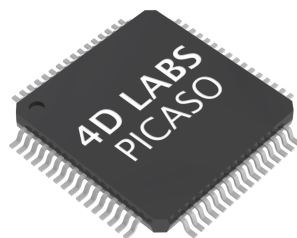

The Picaso is a smart Controller and the interface to the TFT- LCDs is almost plug-n-play.

All of the data and control signals are provided by the chip to interface directly with the display.

Powerful graphics, text, images, animation and countless more features are built right inside the chip.

For more information read the [Picaso Processor](#) datasheet.

5.2. Audio

Audio playback support in the Picaso Processor enables this module to play audio WAV files stored in the micro-SD memory card. PWM audio is generated and made available on the AUDIO pin of the 30-way ZIF connector, ready to interface with an audio amplifier on your application board.

A simple instruction enables the user to play/pause/stop audio files while continuing the execution of the user application code, such as display updates, touch recognition, communications, etc. The audio system also allows real-time pitch change of audio samples.

For a complete list of audio commands please refer to the [Picaso 4DGL Internal Functions](#)

5.3. SD/SDHC Memory Cards

The Picaso processor uses off-the-shelf standard SDHC/SD/microSD memory cards with up to 2GB capacity usable with FAT16 formatting. For any FAT file-related operations, before the memory card can be used it must first be formatted to FAT16. The formatting of the card can be done on any PC system with a card reader. Select the appropriate drive and choose the FAT16 (or just FAT in some systems) option when formatting. The card is now ready to be used in the Picaso-based application.

The Picaso processor also supports high-capacity HC memory cards (4GB and above). The available capacity of SD-HC cards varies according to the way the card is partitioned and the commands used to access it.

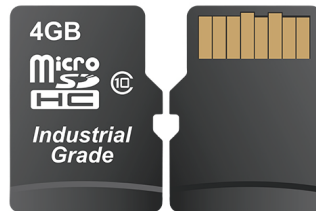

The FAT partition is always first (if it exists) and can be up to the maximum size permitted by FAT16. Windows 7 will format FAT16 up to 4GB. Windows XP will format FAT16 up to 2GB and the Windows XP command prompt will format FAT16 up to 4GB.

RMPET, a 4D Systems Tool found in the Workshop4 IDE, is capable of repartitioning and formatting microSD cards to be the appropriate type and format for 4D Systems processors. This tool should be used for all cards.

 **Note**

1. An SPI Compatible SDHC/SD/microSD card MUST be used. Picaso along with other 4D Systems Processors requires SPI mode to communicate with the SD card. If a non-SPI compatible SD card is used, then the processor will not be able to mount the card.
2. Read disturbance is a well-known issue with flash memory devices, such as microSD cards, where reading data from a flash cell can cause the nearby cells in the same memory block to change over time. This issue can be prevented by using industrial-grade microSD cards with read disturb protection. Industrial-grade microSD cards have firmware that actively monitors the read operation and refreshes areas of memory that have high traffic and even move data around to prevent read disturb error from occurring. Furthermore, manufacturers may choose to implement read disturb protection on a specific part of the flash memory only, such that the beginning part of the memory might not be protected. The RMPET utility in Workshop4 is designed to create the first partition at an offset from the start of the microSD card to account for this situation. It is therefore recommended to always partition and format an industrial microSD card using the RMPET utility before using it with 4D Systems processors. Many commercial grade cards designed for Cameras etc, do not handle read disturb well at all, and therefore it is always recommended to use an Industrial grade microSD card with 4D modules. 4D offers one that is tried and tested, on our website.

5.4. FAT16

All 4D Systems display modules featuring 4D Labs processors use off-the-shelf standard SDHC/SD/micro-SD memory cards (SPI Compatible Only) with up to 4GB capacity usable with FAT16 formatting.

For any FAT file-related operations, before the memory card can be used it must first be formatted correctly. Built into Workshop4 is a tool created by 4D, called RMPET (please refer to the Tools menu, in any Environment, inside the Workshop4 IDE). RMPET allows the User to easily partition and format microSD cards, to make their file system ready to be used with 4D Systems modules. The formatting of the card can be done on any PC system with a card reader.

The Picaso Processor also supports high-capacity HC memory cards (4GB and above). The available capacity of SD-HC cards varies according to the way the card is partitioned and the commands used to access it. Refer to the 4D Systems RMPET tool in the Workshop4 IDE.

A Max of 4GB can be used by the FAT16 file system. The FAT partition is always first (if it exists). Any space larger than 4GB will be RAW, and can still be used by your 4D Systems module, using different functions. Please refer to the [Application Notes](#).

5.5. Application PCB Support

The gen4 2.4" Picaso Integrated Display Module is designed to accommodate a range of applications and therefore is suited for those wanting to make a customised module, without the need for piggyback or daughter boards mounted on headers.

On the back of the gen4 module, the display-related circuitry will be found, which is recessed into plastic. The level of the plastic on the back of the gen4 module is higher than the tallest component on the display circuit PCB, meaning an Application PCB can be mounted on the back of the gen4, without affecting the display-related circuitry.

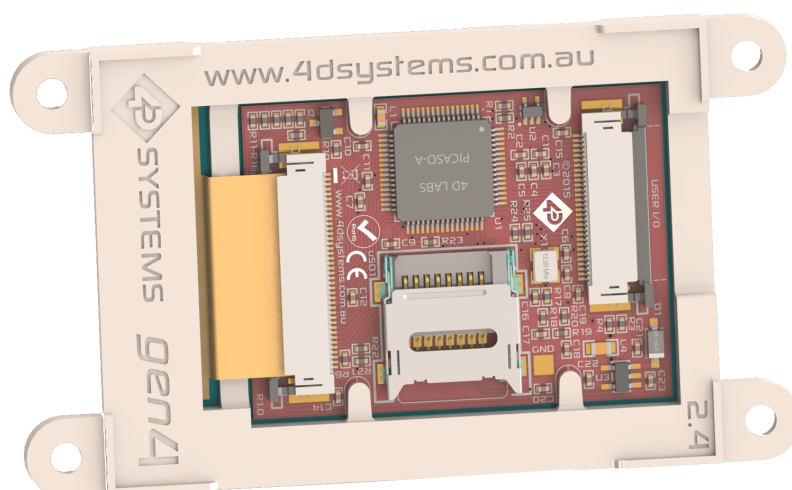

The image below shows a mock Application PCB on the back of the gen4 display (Blue area). It features a cut-out in the PCB so access to the micro-SD socket on the gen4's display board is possible, however, this may or may not be required depending on the application and if the micro-SD socket is used or requiring access once the Application PCB is applied.

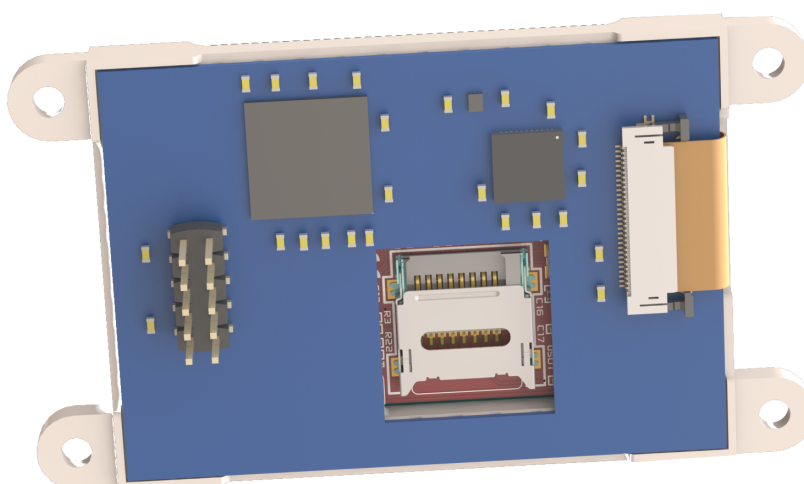

The micro-SD socket is a latch type, so it is accessible from the top, rather than a push/push or push/pull style which is accessible from the side.

5.6. RF / EMI Shielding Support

As per what is written under the [Application PCB Support](#) section, there is an option for extended RF shielding and EMI protection on this module.

On the back of the gen4's display PCB, are grounded plated 'X pads', which make contact with the metal housing of the display.



Where the Application PCB is shown to sit from the [Application PCB Support](#) section, can house a small metal shield of the same size. This shield is used instead of, or underneath an Application PCB, to aid the onboard electronics in the prevention of potential RF or EMI signals.

On the top of the display, PCB is another GND pad, which can have a pogo pin or similar device mounted on it, which can make contact with this metal shield.

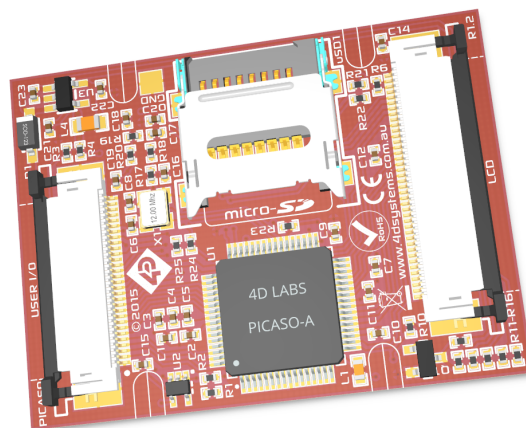

The display electronics are then sandwiched between the display's metal housing, and the metal shield, all connected with a common ground.

Note

There are no guarantees these steps will increase chances or grant access to EMI-related certifications. However, the gen4 can utilise shielding of the module's electronics, should the need arise. This may or may not assist the User with protecting the device against EMI/EMF/RF type noise, depending on the source, strength and type of noise present, but it should aid in the protection. 4D Systems do not make nor stock these, this is an example only, which could be trialed.

6. Display/Module Preparations

- Avoid having to display the same image/object on the screen for lengthy periods. This can cause a burn-in which is a common problem with all types of display technologies. Blank the screen after a while or dim it very low by adjusting the contrast. Better still; implement a screen saver feature.
- Moisture and water can damage the display. Moisture on the surface of a powered display should not cause any problems, however, if water is to enter the display either from the front or from the rear, or come in contact with the PCB, it will damage. Wipe off any moisture gently or let the display dry before usage. If using this display module in an environment where it can get wet, ensure an appropriate enclosure is used.
- Dirt from fingerprint oil and fat can easily stain the surface of the display. Gently wipe off any stains with a soft lint-free cloth.
- The performance of the display will degrade under high temperatures and humidity. Avoid such conditions when storing.
- Do not tamper with the display flex cable that is connected to the control board. This may affect the connection between the display and the driving circuitry and cause failure.
- Displays are susceptible to mechanical shock and any force exerted on the module may result in deformed zebra stripes, a cracked display cell and a broken backlight
- Always use the mounting holes on the module's corner plates to mount the display where possible.
- Display modules have a finite life, which is typically dictated by the display itself, more specifically the backlight. The backlight contains LEDs, which fade over time. In the [Specifications](#) section, is a table for the typical life of the display, and the criteria are listed.
- The resistive Touch model features a touch-sensitive film over the display which is sensitive to pressure. Take note when mounting the display module in an enclosure that pressure is not applied to the surface of the display by the enclosure, false touches will occur, or the touch will simply not function at all.

7. Hardware Tools

The following hardware tools are required for full control of the gen4 Integrated Display Modules.

7.1. 4D-UPA Programming Cable/Adaptor

The 4D programming interfaces are used to program a new Firmware/PmmC, Display Driver and for downloading compiled 4DGL code into the processor. They even serve as an interface for communicating serial data to the PC.

The 4D Programming Cable is a USB to Serial-TTL UART converter cable incorporating the Silabs CP2102 USB to Serial UART bridge IC.



4D Programming Cable

Note

In conjunction with a Programming Cable or a Programming Adaptor, the gen4 series of Display Modules require a simple interface board (gen4-IB), as there is no 5-way male header on gen4 modules like other 4D Systems modules.

gen4 Interface boards (gen4-IB) ship with each gen4 Display Module unless otherwise stated. Simply connect the supplied 30-way FPC cable to the ZIF connector on the gen4 Interface Board, and connect the Programming Cable or Adaptor to the 5-way header on the Interface Board. You are now ready to program using a 4D Programming Cable. This can also be used to interface with other devices such as a 4D Arduino Adaptor Shield, breadboard etc.

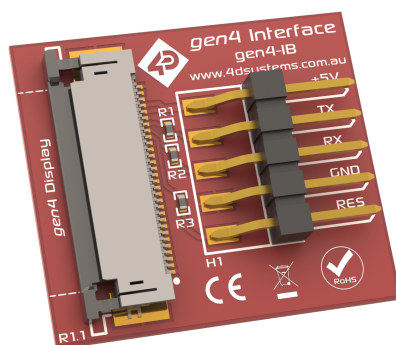

gen4-IB

An alternative to using a gen4-IB and a 4D Programming Cable is a single all-in-one board called the 4D-UPA (4D Universal Programming Adaptor).

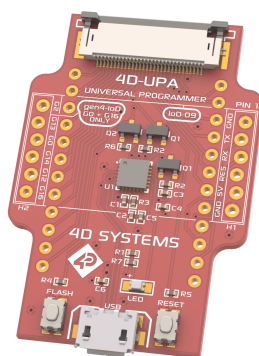

4D-UPA

The 4D-UPA minimizes the connections and modules required for programming - creating a single module with a micro USB interface, and DIP style pads for GPIO breakout of all the signals used on the gen4 Display interface, which is useful for development or final product use.

The GPIO naming convention on the 4D-UPA does not reflect the GPIO naming of the actual display module, due to the 4D-UPA being universal and able to be used with many 4D Products. Please review the 4D-UPA datasheet for information on mapping the GPIO naming from this module, with the GPIO naming on the 4D-UPA, to ensure you connect to the correct pins you desire.

Note

In addition to these modules, the [gen4-PA](#) and [uUSB-PA5/uUSB-PA5-II](#) can still be used. Please be reminded though that the uUSB-PA5/PA5-II still needs a gen4-IB to be used for programming.

Using a non-4D programming interface could damage your processor, and **void your warranty**.

8. Programming Language

The PICASO processor belongs to a family of processors powered by a highly optimised softcore virtual engine called EVE (Extensible Virtual Engine). EVE was designed and created by 4D Systems in the early 2000s, and should not be confused with FTDI's solution of EVE, which was developed a decent decade or so later.

EVE is a proprietary, high-performance virtual machine with an extensive byte-code instruction set optimised to execute compiled 4DGL programs.

4DGL (4D Graphics Language) was specifically developed from the ground up for the EVE engine core. It is a high-level language that is easy to learn and simple to understand yet powerful enough to tackle many embedded graphics applications.

4DGL is a graphics-oriented language allowing rapid application development, and the syntax structure was designed using elements of popular languages such as C, Basic, Pascal and others.

Programmers familiar with these languages will feel right at home with 4DGL. It includes many familiar instructions such as `IF..ELSE..ENDIF`,

`WHILE..WEND`, `REPEAT..UNTIL`, `GOSUB..ENDSUB`, `GOTO`, `PRINT` as well as some specialised instructions `SERIN`, `SEROUT`, `GFX_LINE`, `GFX_CIRCLE` and many more.

For detailed information about the 4DGL language, please refer to the following documents:

- [4DGL Programmers Reference Manual](#)
- [Picaso Internal Functions Manual](#)

To assist with the development of 4DGL applications, the Workshop4 IDE combines a full-featured editor, a compiler, a linker and a downloader into a single PC-based application. It's all you need to code, test and run your applications.

4DGL is available to be written in two of the four environments offered by the Workshop4 IDE, Designer and ViSi. The other two environments, Serial and ViSi-Genie do not directly use 4DGL by the User (Except in Workshop4 Pro, for ViSi-Genie), however, it is present in the background. Serial is an application that runs, and that is written in 4DGL. ViSi-Genie automatically generates 4DGL itself based on what is configured in the GUI. More information about each follows.

9. Workshop4 IDE

Workshop4 is a comprehensive software IDE that provides an integrated software development platform for all of the 4D family of processors and modules. The IDE combines the Editor, Compiler, Linker and Downloader to develop complete 4DGL application code. All user application code is developed within the Workshop4 IDE.



The Workshop4 IDE supports multiple development environments for the user, to cater to different user requirements and skill levels.

- The **Designer** environment enables the user to write 4DGL code in its natural form to program the range of 4D System's intelligent displays.
- A visual programming experience, suitably called **Visi**, enables drag-and-drop type placement of objects to assist with 4DGL code generation and allows the user to visualise how the display will look while being developed.
- An advanced environment called **Visi-Genie** doesn't require any 4DGL coding at all, it is all done automatically for you. Simply lay the display out with the objects you want, set the events to drive them and the code is written for you automatically. This can be extended with additional features when a Workshop4 PRO license is purchased from the 4D Systems website. Extended Advanced features for Visi-Genie are available in the PRO version of WS4. Further details are explained in the [Visi Genie](#) section of the Workshop4 documentation.
- A **Serial** environment is also provided to transform the display module into a slave serial module, allowing the user to control the display from any host microcontroller or device with a serial port.

For more information regarding these environments, refer to the [Workshop4 manuals](#).

The Workshop 4 IDE is available from the [4D Systems website](#).

9.1. PmmC Programming

The DIABLO16 processor is a custom graphics processor. All functionality including the high-level commands is built into the chip. This chip-level configuration is available as a PmmC (Personality-module-micro-Code) file, which can be likened to traditional Firmware. There is also a Display Driver file, which separates specific display settings from the PmmC, unlike on the PICASO processor where everything is combined.

A PmmC file contains all of the low-level micro-code information (analogy of that of a soft silicon) which defines the characteristics and functionality of the device. The ability of programming the device with a PmmC file provides an extremely flexible method of customising as well as upgrading it with future enhancements.

The Display Driver contains the initialisation and parameters associated with the particular display that is to be connected to the DIABLO16 processor, along with product-specific settings and parameters which are required over and above what is found in the PmmC.

The PmmC file and Display Driver file can only be programmed into the device via the COM0 serial port with the aid of Workshop 4, the 4D Systems IDE software.

Solutions, which remove the need to use Workshop4 to program the display modules, are available for commercial customers requiring batch programming or production line programming. These solutions are practical for production staff and minimize the chance of unwanted or unauthorised modifications on the production line.

Three solutions come with the Workshop4 IDE, which can be separated for production line computers if required, **ScriptC**, **PmmC Loader** and **Program Loader**.

ScriptC is a command line interface that can be controlled from a Batch Script or similar, useful for repetitive loading or when controlled from an external application. Example scripts are provided, showing how to load PmmC, Display Drivers and Applications using a batch script.

Program Loader is a GUI interface designed to download Applications to either Flash or RAM, useful for testing or production loading, without the need for Workshop4 itself.

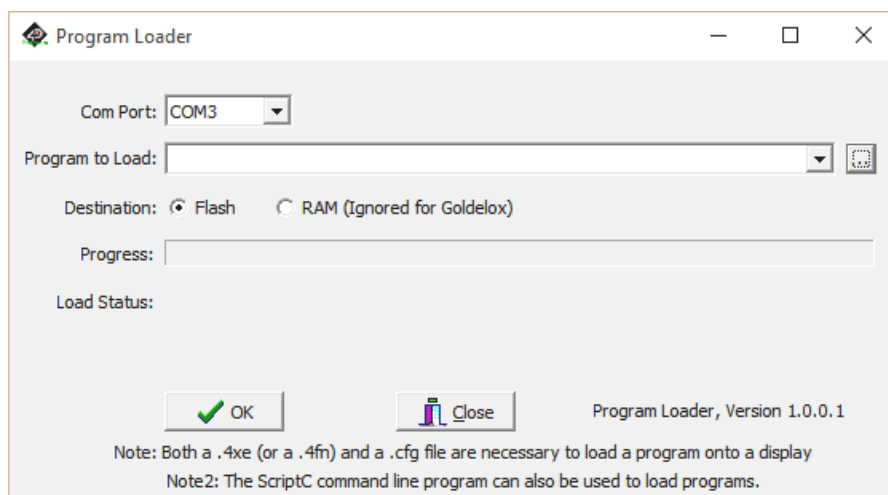

PmmC Loader is a GUI interface designed to download PmmC's and Drivers to 4D Systems Processors. It can automatically update existing PmmC's and Drivers present on a module, or manually change or force download to a blank processor or module, overwriting anything written in previously.

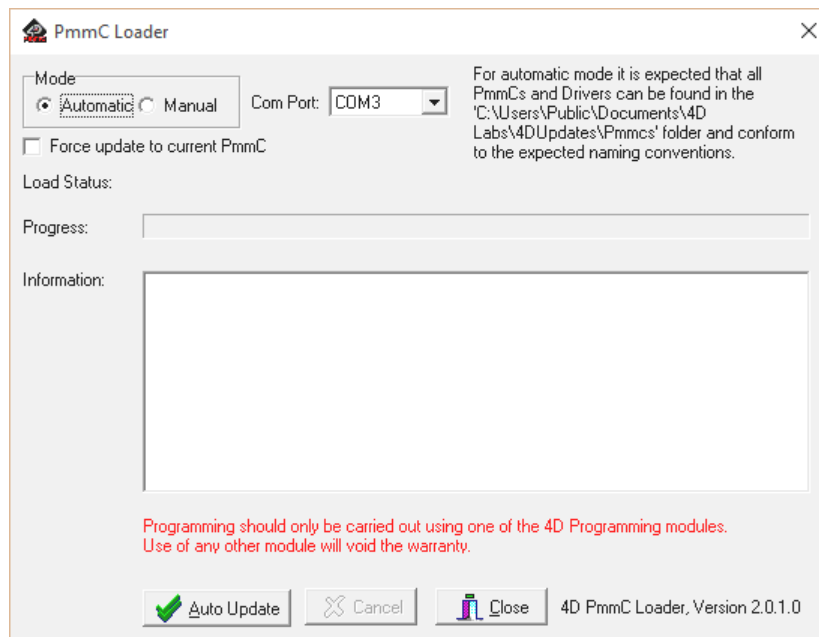

Please contact our Support Team for more information on what we can provide. Some solutions also exist for external processor-based loading, if there is a requirement for that. This solution is available under NDA. Using a non-4D programming interface could damage your module, and **void your warranty**.

10. Display Module Part Numbers

The following is a breakdown of the part numbers and what they mean.

Example:

· gen4-uLCD-24PT-CLB-SB

where:

gen4 - gen4 Display Range

uLCD - microLCD Display Family

24 - Display size (2.4")

P - Picaso Processor

T - Resistive Touch

11. FFC Cable

The FFC cables supplied by 4D Systems (included with products) have the following specifications:

- **30 Pin** Flexible Flat Cable, 150mm Long, 0.5mm (0.02") pitch
- Cable Type: AWM 20624 80C 60V VW-1
- Heat Resistance 80 Degrees Celsius
- Connections on the opposite side at each end (Type B)

Note

You can get different cable lengths by contacting the 4D Systems sales team.

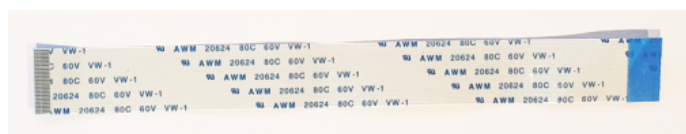

If you are interfacing with this module directly to your product, and wish to interface via the FFC cable directly, suitable connectors are readily available from many electronics suppliers, such as Digikey, Mouser, Farnell, RS, etc.

A standard 30-pin, 0.5mm pitch, 0.3mm thick FFC, FFC connector. They are available in Top Contact and Bottom Contact, so depending how you orientate the cable on your product, will determine which one you need. Please however take care of the pinout and how it flows from the display module, through the FFC and into your product, to ensure Pin1 and Pin30 are where you expect them to be.

12. Starter Kit

4D Systems highly recommends all first-time buyers of 4D Systems' displays, to purchase the Starter Kit when purchasing their first 4D Systems display solution.

The Starter Kit provides all the hardware that is required to get the User up and running.

Not all development environments and features will be needed by every User. However, purchasing the display solution in a Starter Kit allows you to take full advantage of all of the features of the 4D Systems Display Solution and try out each of the 4D Workshop4 Environments before settling with the preferred feature set.

The **Designer** environment can utilise every feature of the display, however, depending on the user requirements, a micro-SD (uSD) card may not be required. The uSD card is used when displaying images/video/sound, along with data logging to uSD, and a programming cable or adaptor is required for downloading compiled code and PmmC/Firmware updates.

The **Visi** environment is the same as Designer in terms of feature utilisation, but is image based so requires a uSD card, along with a programming cable.

The **Visi-Genie** environment is also image-based, and therefore requires a uSD card and programming cable also.

The **Serial** environment does not require either a uSD or Programming cable to be used once the module has been configured as a Serial device, however, can utilise both depending on the user's requirements. The uSD card can be used for such things as storage and display of multimedia files, data logging, and the Programming cable for PmmC/Firmware updates, or changing to one of the other three programming environments.

Starter Kits typically include:

- gen4 Integrated Display Module
- gen4 Interface Module (gen4-IB)
- 4D Universal Programming Adaptor (4D-UPA)
- 4GB micro-SD Card
- 5-way cable for easy connection to a breadboard or host via the gen4-IB
- 150mm 30-way FFC cable for connecting gen4 display to gen4-IB or 4D-UPA

Please refer to the [4D Systems website](#) for the current components included in the Starter Kit.

Simply select the Starter Kit option when purchasing the chosen display module on the 4D Systems shopping cart, or from your local distributor.

13. Mechanical Details

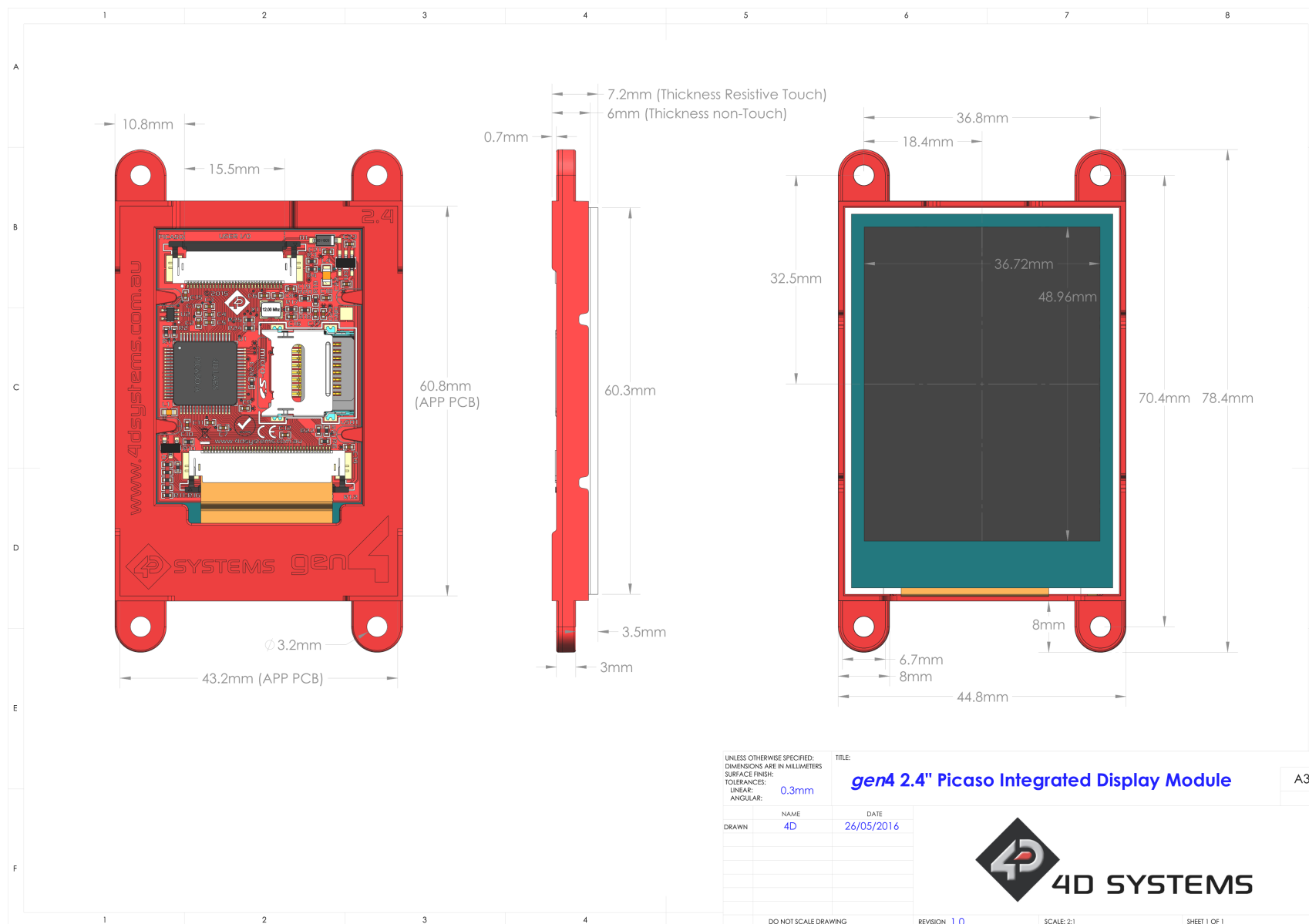

14. Schematic Details

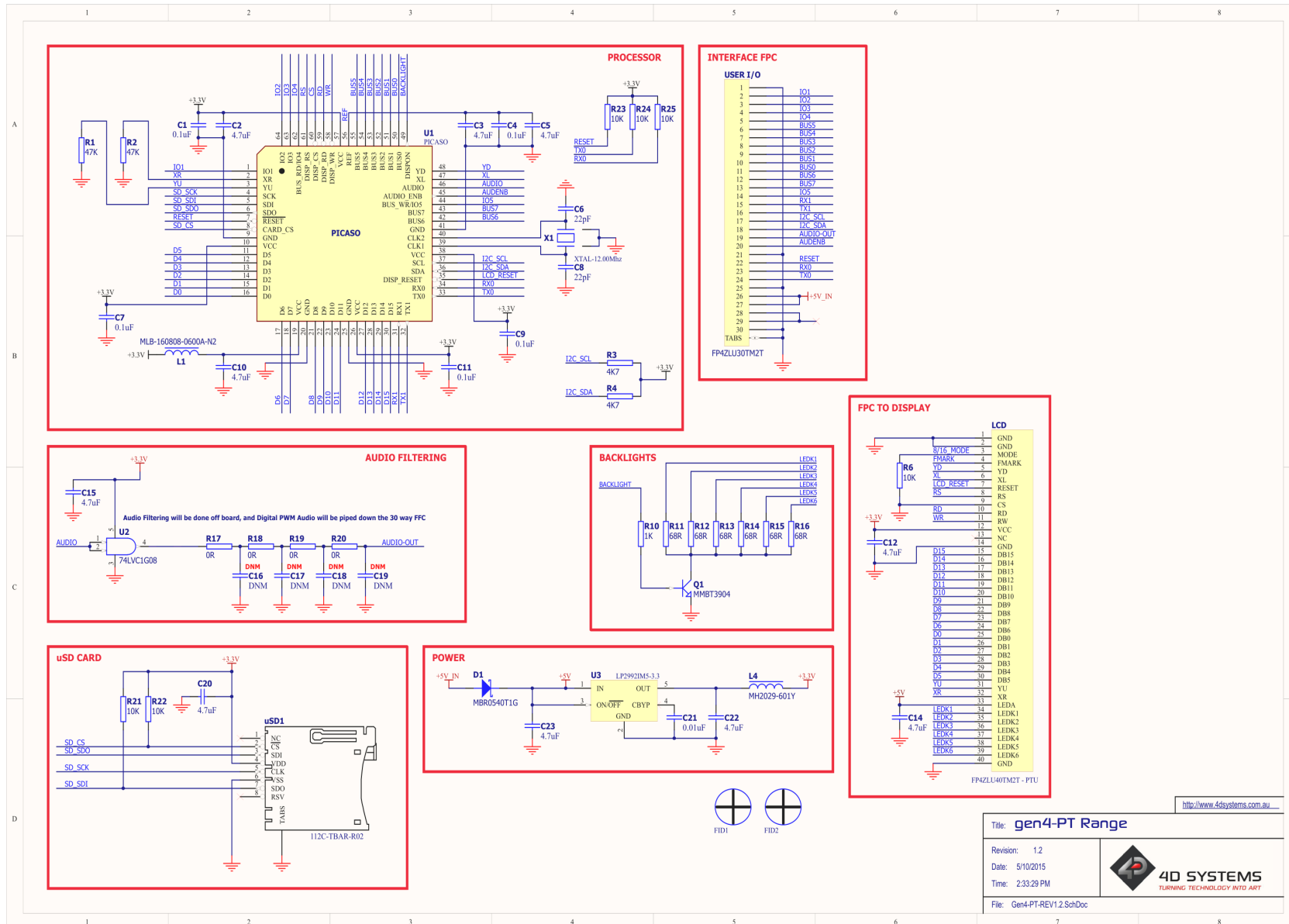

http://www.4dsystems.com.au

Title: **gen4-PT Range**

Revision: 1.2
 Date: 5/10/2015
 Time: 2:33:29 PM

File: Gen4-PT-REV1.2.SchDoc

4D SYSTEMS
TURNING TECHNOLOGY INTO ART

15. Specifications

Absolute Maximum Ratings

Operating ambient temperature	-20°C to +70°C
Storage temperature	-30°C to +80°C
Voltage on any digital input pin with respect to GND	-0.3V to 6.0V
Voltage on VCC with respect to GND	-0.3V to 6.0V
Maximum current sunk/sourced by any pin	4.0mA
Maximum current sunk/sourced by all ports	200.0mA

Note

Stresses above those listed here may cause permanent damage to the device. This is for stress rating only and functional operation of the device at those or any other conditions above those indicated in the recommended operation listings of this specification is not implied. Exposure to maximum rating conditions for extended periods may affect device reliability.

Recommended Operating Conditions

Parameter	Conditions	Min	Typ	Max	Unit
Supply Voltage (VCC)	Stable external supply required	4.0	5.0	5.5	V
Processor voltage (VP)		--	3.3	--	V
Input Low Voltage (VIL)	all pins	0	--	0.2VP	V
Input High Voltage (VIH)	non 5V tolerant pins	0.8VP	--	3.3	V
Input High Voltage (VIH)	PA4-PA13, RX0 and TX0 pins	0.8VP	--	5.5	V
Reset Pulse	External Open Collector	2.0	--	--	μs
Operational Delay	Power-Up or External Reset	500	--	3000	ms

 Global Characteristics Based on Operating Conditions					
Parameter	Conditions	Min	Typ	Max	Unit
Supply Current (ICC)	5V Supply	--	150	--	mA
Display Endurance	Hours of operation, measured to when the display is 50% original brightness	30000	--	--	Hours
Touch Screen Endurance (Resistive Touch)	Number of touches/hits with a 12.5mm tip at a rate of 2x per second with 250gf force	--	1M	--	Touches
	Slide stylus on screen, 100gf force, 60mm/s speed with a 0.8mm polyacetal tip stylus pen	--	100K	--	Slides
Touch Screen Transparency		80	--	--	%
Touch Screen Operational Force	Only use Finger or Stylus, do not use anything sharp or metal	20	--	100	g

 **LCD DISPLAY INFORMATION (TN DISPLAY)**

Parameter	Conditions	Specification
Display Type	gen4-uLCD-24PT – Modules produced before January 2021	TN - TFT Transmissive LCD
Display Size		2.4" Diagonal
Display Resolution		240 x 320 (Portrait View)
Display Brightness	5V Supply - gen4-uLCD-24PT	182 cd/m ²
Display Contrast Ratio	Typical	250:1
Display Viewing Angles	Above Centre	35 Degrees
	Below Centre	55 Degrees
	Left of Centre	55 Degrees
	Right of Centre	55 Degrees
Display Viewing Direction		6 O'clock Display (Optimal viewing is from below when in Portrait mode)
Display Backlighting	White LED Backlighting	1x4 Parallel LED's
Pixel Pitch		0.153 x 0.153 mm (Square pixels)
Pixel Density	Number of pixels in 1 row in 25.4mm	166 DPI/PPI

 **LCD DISPLAY INFORMATION (IPS DISPLAY)**

Parameter	Conditions	Specification
Display Type	gen4-uLCD-24PT – Modules produced January 2021 onwards.	IPS - TFT Transmissive LCD
Display Size		2.4" Diagonal
Display Resolution		240 x 320 (Portrait View)
Display Brightness	5V Supply, gen4-uLCD-24PT	270 cd/m2 (typical)
Display Contrast Ratio	Typical	800:1
Display Viewing Angles	Above Centre	80 Degrees
	Below Centre	80 Degrees
	Left of Centre	80 Degrees
	Right of Centre	80 Degrees
Display Viewing Direction		ALL (wide viewing IPS Display)
Display Backlighting	White LED Backlighting	1x4 Parallel LED's
Pixel Pitch		0.153 x 0.153 mm (Square pixels)
Pixel Density	Number of pixels in 1 row in 25.4mm	166 DPI/PPI

 **Note**

Relevant for both TN and IPS displays, the Displays used are of the highest rated 'Grade A', which allows for 0-4 defective pixels. A defective pixel could be solid Black (Dead), White, Red, Green or Blue.