

gen4-uLCD-43D Series

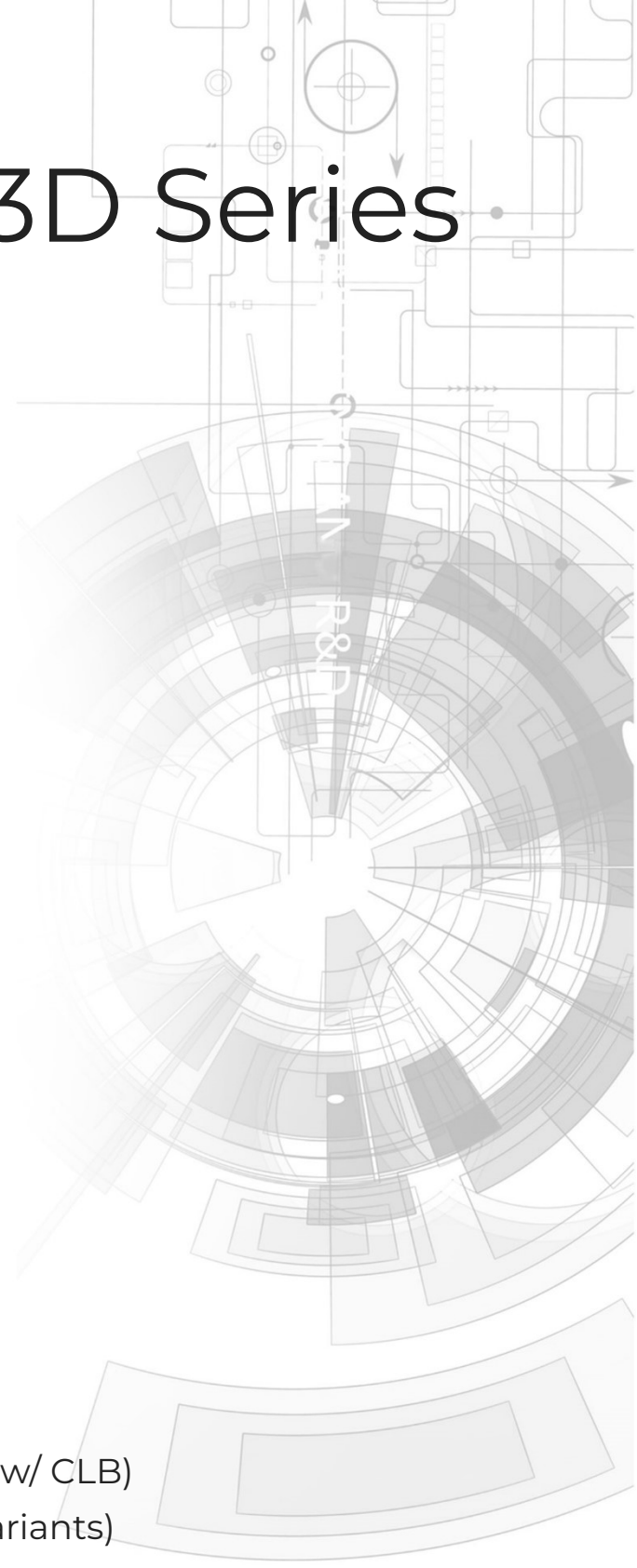

gen4-uLCD-43D (Non-touch)

gen4-uLCD-43D-CLB (Non-touch w/ CLB)

gen4-uLCD-43DT (Resistive touch)

gen4-uLCD-43DCT (Capacitive touch)

gen4-uLCD-43DCT-CLB (Capacitive touch w/ CLB)

gen4-uLCD-43Dxx-xxx-SB (Super Bright variants)

Datasheet

Revision 1.14

Copyright © 2023 4D Systems

Content may change at any time. Please refer to the resource centre for latest documentation.

Contents

1. Description	4
2. Features	5
3. Hardware Overview	6
4. Hardware Interface - Pins	8
4.1. Serial Ports - TTL Level	8
4.2. General Purpose I/O	11
4.3. System Pins	13
4.4. Alternate Pin Function Overview	14
4.5. SPI	17
4.6. I2C	18
4.7. Pulse Out	19
4.8. PWM Out	20
4.9. Pin Counter	21
4.10. Quadrature In	22
4.11. Analog Inputs	23
5. Module Features	24
5.1. DIABLO16 Processor	24
5.2. Audio	24
5.3. SD/SDHC Memory Cards	25
5.4. FAT16	26
5.5. Application PCB Support	26
5.6. RF / EMI Shielding Support	27
6. Display/Module Precautions	29
7. Hardware Tools	30
7.1. 4D-UPA Programming Cable/Adaptor	30
8. Programming Language	32

9. Workshop4 IDE	33
9.1. PmmC Programming	34
10. Display Module Part Numbers	36
11. Cover Lens Bezel - Tape Spec	36
12. FFC Cable	37
13. Starter Kit	38
14. Mechanical Details (Non-Touch & Resistive Touch)	39
15. Mechanical Details (Non-Touch CLB & Capacitive Touch CLB)	40
16. Mechanical Details (Capacitive Touch - Non-CLB)	41
17. Schematic Details (HW REV 1.2)	42
18. Schematic Details (HW REV 1.3)	43
19. Schematic Details (HW REV 1.5)	44
20. Schematic Details (HW REV 2.1)	45
21. Specifications	46
22. Revision History	50

1. Description

The gen4 4.3" Diablo16 Intelligent Display Module belongs to the latest gen4 range of modules Designed and Manufactured by 4D Systems.

This specific gen4 module features a 4.3" colour TFT LCD, with non-Touch (D), Resistive Touch (DT), or Capacitive Touch (DCT), microSD memory Storage, GPIO and Communications, along with multiple millisecond resolution timers, and Audio Generation built-in.

It is powered by the feature-rich 4D Labs Diablo16 Graphics Processor, which offers a wide range of functionality and options for any Designer / Integrator / User.

Diablo16 processor features include 16 customisable GPIO, capable of PWM, Serial, I2C, SPI, Pulse Out, Quadrature Input, and Analog Input.

The standalone display also features a 30-pin ZIF/FFC/FPC socket, designed for a 30-pin FFC cable, for easy and simple connection to an application or mother board, or for connecting to accessory boards for added range of functionality advancements.

gen4 range family of products is all designed to be fully compatible with the Workshop4 IDE and its four different development environments, providing the User necessary tools and options for programming and manipulating the display to their desired function for their system project.

Any code designed and written to run on other 4D Systems display modules featuring Picaso or Diablo16 Graphics Processors can be run on this gen4 Intelligent Display Module, with little or no required modifications. Please contact 4D Systems Support Team for assistance if you are planning on migrating from a previous model.

The gen4 series of modules has been carefully designed from top to bottom for easy integration and use, with meticulous consideration for space requirements to minimize the impact of display-related circuitry. Thereby, allowing application boards to sit flush on the back of the gen4 if required, as the display-related electronics sit inside the plastic mounting base, leaving the application board surface clear for User circuitry.

2. Features

- Powerful 4.3" Intelligent LCD-TFT display module powered by DIABLO16.
 - 480 x 272 Resolution, RGB 65K true to-life colours, TFT Screen with non-touch (D), integrated 4-wire Resistive Touch Panel (DT) or Capacitive Touch Panel (DCT).
 - 6 banks of 32750 bytes of Flash memory for User Application Code and Data.
 - 32Kb of SRAM purely for the User.
 - 16 General Purpose I/O pins for user interfacing, which include 4 configurable Analog Inputs.
 - The GPIO is variously configurable for alternative functions such as:
 - 3x I2C channels available.
 - 1x SPI dedicated for SD Card and 3x configurable SPI channels > available.
 - 1x dedicated and 3x configurable TTL Serial comm ports > available.
 - Up to 6 GPIO can be used as Pin Counters.
 - Up to 6 GPIO for PWM (simple and Servo).
 - Up to 10 GPIO for Pulse Output.
 - Up to 14 GPIO can be configured for Quadrature Encoder Inputs (2 > channels).
 - 30pin FPC connection, for all signals, power, communications, GPIO and programming.
 - Latch-type micro-SD memory card connector for multimedia storage and data logging purposes.
 - DOS-compatible file access (FAT16 format) as well as low-level access to card memory.
 - Dedicated PWM Audio pin for sound generation, for an external amplifier.
 - Display full colour images, animations, icons and video clips.
 - Supports all available Windows fonts.
 - 4.0V to 5.5V range operation (single supply).
 - 4x mounting tabs with 4.0mm holes for mechanical mounting using M4 screws (D/DT Models only).
 - RoHS, REACH and CE compliant.
-
- | | |
|--|--|
| <ul style="list-style-type: none"> • Module dimensions: • (D): 127.6 x 69.3 x 6.7mm • (D-CLB): 123.0 x 84.5 x 7.4mm • (DT): 127.6 x 69.3 x 7.8mm • (DCT): 127.6 x 69.3 x 8.1mm • (DCT-CLB): 123.0 x 84.5 x 8.4mm | <ul style="list-style-type: none"> • Weighing: • (D): ~ 63g • (D-CLB): ~ 87g • (DT): ~ 78g • (DCT-CLB): ~ 90g • (DCT-CLB): ~ 95g |
|--|--|

3. Hardware Overview

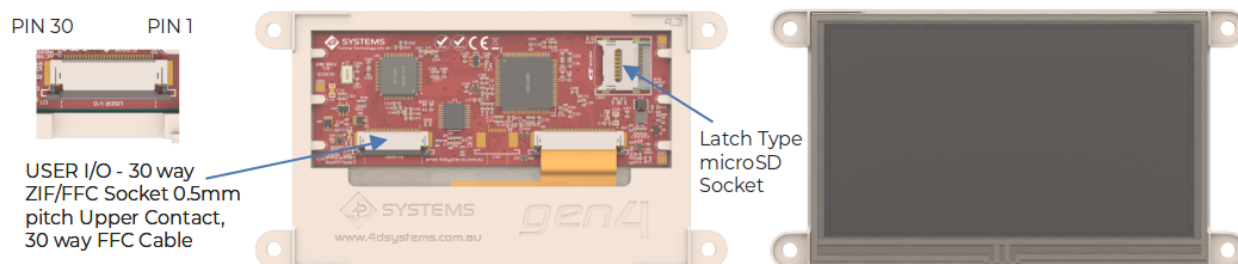

FPC Pinout

Pin	Symbol	I/O	Description
1	GND	P	Supply Ground
2	PA3	I/O/A	General Purpose I/O pin with Analog Capability. This pin has a range of 0-3.3V when used as an Analog Input, and is 3.3V tolerant only. Also used for Bus Read.
3	PA2	I/O/A	General Purpose I/O pin with Analog Capability. This pin has a range of 0-3.3V when used as an Analog Input, and is 3.3V tolerant only. Also used for Bus Write.
4	PA1	I/O/A	General Purpose I/O pin with Analog Capability. This pin has a range of 0-3.3V when used as an Analog Input, and is 3.3V tolerant only.
5	PA0	I/O/A	General Purpose I/O pin with Analog Capability. This pin has a range of 0-3.3V when used as an Analog Input, and is 3.3V tolerant only.
6	PA9	I/O	General Purpose Input/Output, 3.3V Level - 5V Tolerant
7	PA8	I/O	General Purpose Input/Output, 3.3V Level - 5V Tolerant
8	PA7	I/O	General Purpose Input/Output, 3.3V Level - 5V Tolerant
9	PA6	I/O	General Purpose Input/Output, 3.3V Level - 5V Tolerant
10	PA5	I/O	General Purpose Input/Output, 3.3V Level - 5V Tolerant
11	PA4	I/O	General Purpose Input/Output, 3.3V Level - 5V Tolerant
12	PA10	I/O	General Purpose Input/Output, 3.3V Level - 5V Tolerant
13	PA11	I/O	General Purpose Input/Output, 3.3V Level - 5V Tolerant
14	PA12	I/O	General Purpose Input/Output, 3.3V Level - 5V Tolerant. Note this pin is used for CTP (and CTP-CLB) models and is not available to the User.
15	PA13	I/O	General Purpose Input/Output, 3.3V Level - 5V Tolerant. Note this pin is used for CTP (and CTP-CLB) models and is not available to the User.
16	PA14	I/O	General Purpose Input/Output, 3.3V Tolerant only. Special I2C Pin.
17	PA15	I/O	General Purpose Input/Output, 3.3V Tolerant only. Special I2C Pin.
18	NC	-	Not Connected

Pin	Symbol	I/O	Description
19	AUDIO_OUT	O	Audio Output, Filtered PWM, to feed into external Amplifier
20	AUDENB	O	Audio Amplifier Enable, to enable/disable external Amplifier
21	GND	P	Supply Ground
22	RESET	I	Master Reset signal. Internally pulled up to 3.3V via a 10K resistor. An active Low pulse greater than 2 micro-seconds will reset the module. If the module needs to be reset externally, only use open collector-type circuits. This pin is not driven low by any internal conditions. The host should control this pin via one of its port pins using an open collector/drain arrangement.
23	RX0	I	Asynchronous Serial Receive pin, TTL level. Connect this pin to the Transmit (Tx) signal of other serial devices. Used in conjunction with the TX pin for programming this micro LCD. This pin is tolerant up to 5.0V levels.
24	TX0	O	Asynchronous Serial Transmit pin, TTL level. Connect this pin to the Receive (Rx) signal of other serial devices. Used in conjunction with the RX pin for programming this micro LCD. This pin is tolerant up to 5.0V levels.
25	GND	P	Supply Ground
26	5V IN	P	Main Voltage Supply +ve input pin. Reverse polarity protected. The range is 4.0V to 5.5V, nominal 5.0V.
27	5V IN	P	Main Voltage Supply +ve input pin. Reverse polarity protected. The range is 4.0V to 5.5V, nominal 5.0V.
28	NC	-	Not Connected
29	NC	-	Not Connected
30	GND	P	Supply Ground

 **Note**

I = Input, **O** = Output, **P** = Power

4. Hardware Interface - Pins

This section describes in detail the hardware interface pins of the device.

4.1. Serial Ports - TTL Level

The DIABLO16 Processor has three hardware asynchronous serial ports (COM1 - COM3) that can be configured on a variety of processors' GPIO pins. TX/RX0 (COM0) is dedicated and its pins are fixed. All of the DIABLO16's serial ports can be used to communicate with external serial devices.

TX/RX0 is referred to as COM0 and is the only one used for programming the DIABLO16 itself.

The primary features are:

- Full-Duplex 8-bit data transmission and reception.
- Data format: 8 bits, No Parity, 1 Stop bit.
- Independent Baud rates from 300 baud up to 600K baud.
- Single byte transmits and receives a fully buffered service. The buffered service feature runs in the background capturing and buffering serial data without the user application having to constantly poll any of the serial ports. This frees up the application to service other tasks.

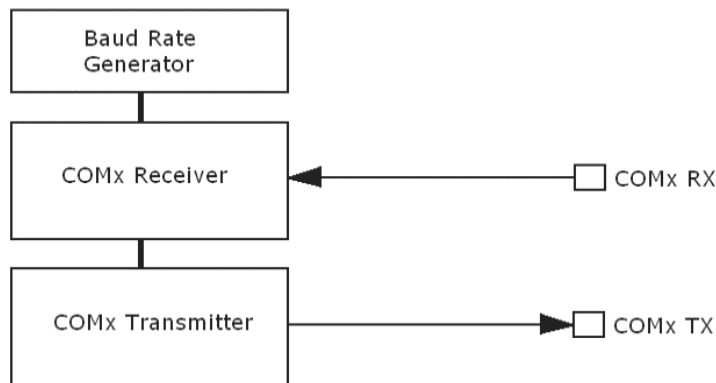

A single-byte serial transmission consists of the start bit, 8 bits of data followed by the stop bit. The start bit is always 0, while a stop bit is always 1. The LSB (Least Significant Bit, Bit 0) is sent out first following the start bit. The figure below shows a single-byte transmission timing diagram.

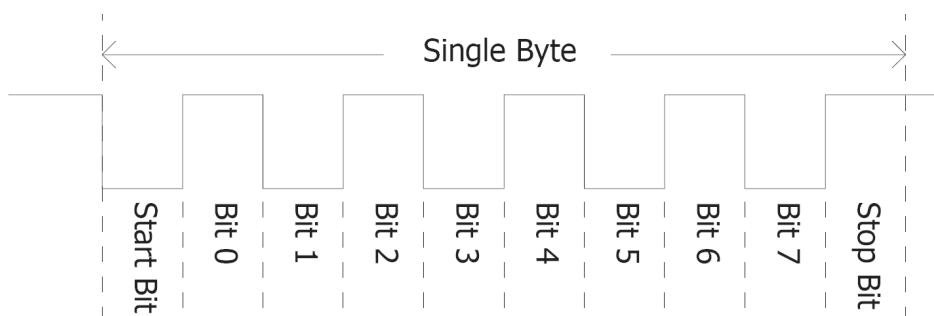

COM0 is also the primary interface for User program downloads and configuration PmmC /Driver programming. Once the compiled 4DGL application program (EVE byte-code) is downloaded and the user code starts executing, the serial port is then available to the user application.

TX0 pin (Serial Transmit COM0):

Dedicated Asynchronous Serial port COM0 transmit pin, TX0. Connect this pin to the external serial device receive (Rx) signal. This pin is 5.0V tolerant.

RX0 pin (Serial Receive COM0):

Dedicated Asynchronous Serial port COM0 receive pin, RX0. Connect this pin to an external serial device transmit (Tx) signal. This pin is 5.0V tolerant.

TX1 pin (Serial Transmit COM1):

Asynchronous Serial port COM1 transmit pin, TX1. Connect this pin to the external serial device receive (Rx) signal. This can be configured to one of the GPIO pins, see the [table](#) below.

RX1 pin (Serial Receive COM1):

Asynchronous Serial port COM1 receive pin, RX1. Connect this pin to an external serial device transmit (Tx) signal. This can be configured to one of the GPIO pins, see the [table](#) below.

TX2 pin (Serial Transmit COM2):

Asynchronous Serial port COM2 transmit pin, TX2. Connect this pin to the external serial device receive (Rx) signal. This can be configured to one of the GPIO pins, see the [table](#) below.

RX2 pin (Serial Receive COM2):

Asynchronous Serial port COM2 receive pin, RX2. Connect this pin to an external serial device transmit (Tx) signal. This can be configured to one of the GPIO pins, see the [table](#) below.

TX3 pin (Serial Transmit COM3):

Asynchronous Serial port COM3 transmit pin, TX3. Connect this pin to the external serial device receive (Rx) signal. This can be configured to one of the GPIO pins, see the [table](#) below.

RX3 pin (Serial Receive COM3):

Asynchronous Serial port COM3 receive pin, RX3. Connect this pin to an external serial device transmit (Tx) signal. This can be configured to one of the GPIO pins, see the [table](#) below.

DIABLO16 Serial TTL Comm Port Configuration Options							
	TX1	RX1	TX2	RX2	TX3	RX3	
PA0		Yes		Yes			Yes
PA1	Yes	Yes	Yes	Yes	Yes	Yes	Yes
PA2		Yes		Yes			Yes
PA3	Yes	Yes	Yes	Yes	Yes	Yes	Yes
PA4	Yes	Yes	Yes	Yes	Yes	Yes	Yes
PA5	Yes	Yes	Yes	Yes	Yes	Yes	Yes
PA6	Yes	Yes	Yes	Yes	Yes	Yes	Yes
PA7	Yes	Yes	Yes	Yes	Yes	Yes	Yes
PA8	Yes	Yes	Yes	Yes	Yes	Yes	Yes
PA9	Yes	Yes	Yes	Yes	Yes	Yes	Yes
PA10		Yes		Yes			Yes
PA11		Yes		Yes			Yes
PA12	Yes	Yes	Yes	Yes	Yes	Yes	Yes
PA13	Yes	Yes	Yes	Yes	Yes	Yes	Yes
PA14							
PA15							

As per the table, not all GPIO can be configured to be every serial port, or RX/TX.

Note

Pins **PA4-PA13** are 5.0V tolerant, while pins **PA0-PA3, PA14, PA15** are 3.3V tolerant only. All pins output at 3.3V levels.

Please refer to the [Diablo16 Internal Functions Manual](#) datasheet for information on how to set the DIABLO16 pin mappings.

4.2. General Purpose I/O

There are 16 general-purpose Input/Output (GPIO) pins available to the user. These provide flexibility for individual bit operations along with serving collectively for byte-wise operations using the BUS functions

DIABLO16 Alternate Pin Configurations GPIO					
	Digital Input	Digital Output	Bus Read	Bus Write	Analog Read
PA0	Yes	Yes	Yes	Yes	Yes
PA1	Yes	Yes	Yes	Yes	Yes
PA2	Yes	Yes	Yes	Yes	Yes
PA3	Yes	Yes	Yes	Yes	Yes
PA4	Yes	Yes	Yes	Yes	
PA5	Yes	Yes	Yes	Yes	
PA6	Yes	Yes	Yes	Yes	
PA7	Yes	Yes	Yes	Yes	
PA8	Yes	Yes	Yes	Yes	
PA9	Yes	Yes	Yes	Yes	
PA10	Yes	Yes	Yes	Yes	
PA11	Yes	Yes	Yes	Yes	
PA12	Yes	Yes	Yes	Yes	
PA13	Yes	Yes	Yes	Yes	
PA14	Yes	Yes	Yes		
PA15	Yes	Yes	Yes		

Please refer to the [Diablo16 Internal Functions Manual](#) datasheet for information on how to set the DIABLO16 pin mappings.

PA0-PA3:

General purpose I/O pins, or can serve as Analog Input pins. Each pin can be individually set for INPUT or OUTPUT or ANALOG. Power-Up Reset default is all INPUTS. Digital GPIO can source/sink 10mA. For more information, the Specifications section. These pins have a **0** to **3.3V** range and have a 12-bit resolution.

For more information, refer to the [Analog Inputs Section](#) section.

PA4-PA11:

General purpose I/O pins. Each pin can be individually set for INPUT or OUTPUT. Power-Up Reset default is all INPUTS. When set as Digital Inputs, the pins are 5V tolerant. Digital GPIO can source/sink 10mA. For more information, see the Specifications Section.

PA12-PA13:

PA12 and PA13 are reserved and are used exclusively for the resistive touch controller, or the capacitive touch controller (DT/DCT models). These pins should not be connected else Touch performance may be degraded. There are 4.7K pullup resistors on each of this GPIO. Avoid these pins in normal situations. However, using these pins on non-touch (D model) is OK, or in situations where touch is not required. These pins are 5V tolerant

PA14-PA15:

General purpose I/O pins. Each pin can be individually set for INPUT or OUTPUT. Power-Up Reset default is all INPUTS. When set as Digital Inputs, the pins are 3.3V tolerant. Digital GPIO can source/sink 10mA. Under special situations, these pins can be utilised for a high speed I2C interface. Please refer to the [table](#) under the [Alternate Pin Function Overview](#) section and the information under the [I2C](#) section.

 **Note**

Digital GPIO pins are 5.0V tolerant, except PA14-PA15, which are 3.3V tolerant only. PA0-PA3 are 3.3V tolerant only. All pins output at 3.3V levels.

4.3. System Pins

+5V IN (Module Voltage Input):

Module supply voltage input pins. Both of these pins should be connected to a stable supply voltage in the range of 4.0 Volts to 5.5 Volts DC. Nominal operating voltage is 5.0 Volts. Note backlight brightness will be lower for voltages under 5.0V.

GND (Module Ground):

Device ground pins. At least two pins should be connected to the ground.

RESET (Module Master Reset):

Module Master Reset pin. An active low pulse of greater than 2 μ s will reset the module. Internally pulled up to 3.3V via a 10K resistor. Only use open collector type circuits to reset the device if an external reset is required.

AUDENB (Audio Enable Output):

Output dedicated to enable or disable and external amplifier, where required.

AUDIO (PWM Audio Output):

Output specifically for Audio. This pin is a PWM output from the DIABLO16 Processor. This pin is a 3.3V level PWM output to drive an external amplifier with DIABLO16 generated Audio, via an external filtering circuit to turn digital PWM into Analog. Note that AUDENB must be enabled in DIABLO16 for any input signal to be heard.

4.4. Alternate Pin Function Overview

Most of the GPIO pins have an alternate function other than being for General Purpose I/O.

GPIO pins can be configured to be SPI, I²C, Serial or a range of other functions.

Note

Not all pins can be configured to be any of the alternate pin functions. Please refer to the tables.

Refer to the tables below that illustrate the GPIO pins you can associate with alternative functions.

DIABLO16 Alternate Pin Configurations I/O Support Functions

	Pulse Out	PWM Out	Pin Counter	Quadrature In
PA0	Yes			Yes
PA1	Yes			Yes
PA2	Yes			Yes
PA3	Yes			Yes
PA4	Yes	Yes	Yes	Yes
PA5	Yes	Yes	Yes	Yes
PA6	Yes	Yes	Yes	Yes
PA7	Yes	Yes	Yes	Yes
PA8	Yes	Yes	Yes	Yes
PA9	Yes	Yes	Yes	Yes
PA10				Yes
PA11				Yes
PA12				Yes
PA13				Yes
PA14				
PA15				

Note

- Once you allocate a pin to an alternate function, you can't allocate another pin to the same alternate function.
- Quadrature In requires 2 Pins

The [table](#) above illustrates the GPIO pins you can use for the 4 different I/O Support Functions.

Please refer to the [Diablo16 Internal Functions Manual](#) datasheet for more information on how to set the alternate pin configurations.

The Alternate pin functions have been broken up into a few tables for simplification. There are communication-based functions and I/O support-based functions.

Further information is available in the next sections for each of the alternative pin functions.

The table below illustrates the GPIO pins you can use for the three different SPI channels available.

 DIABLO16 Alternate Pin Configurations SPI Communications									
	SPI1 SDO	SPI1 SDI	SPI1 SCK	SPI2 SDO	SPI2 SDI	SPI2 SCK	SPI3 SDO	SPI3 SDI	SPI3 SCK
PA0		Yes			Yes			Yes	
PA1	Yes	Yes	Yes	Yes	Yes	Yes	Yes	Yes	Yes
PA2		Yes			Yes			Yes	
PA3	Yes	Yes	Yes	Yes	Yes	Yes	Yes	Yes	Yes
PA4	Yes	Yes	Yes	Yes		Yes	Yes	Yes	Yes
PA5	Yes	Yes	Yes	Yes		Yes	Yes	Yes	Yes
PA6	Yes	Yes	Yes	Yes		Yes	Yes	Yes	Yes
PA7	Yes	Yes	Yes	Yes		Yes	Yes	Yes	Yes
PA8	Yes	Yes	Yes	Yes		Yes	Yes	Yes	Yes
PA9	Yes	Yes	Yes	Yes		Yes	Yes	Yes	Yes
PA10		Yes			Yes			Yes	
PA11		Yes			Yes			Yes	
PA12	Yes	Yes	Yes	Yes		Yes	Yes	Yes	Yes
PA13	Yes	Yes	Yes	Yes		Yes	Yes	Yes	Yes
PA14									
PA15									

The table below illustrates the GPIO pins you can use for the three different I²C channels available.

 DIABLO16 Alternate Pin Configurations I²C Communication							
	I ² C1 SDA	I ² C1 SCL	I ² C2 SDA	I ² C2 SCL	I ² C3 SDA	I ² C3 SCL	
PA0	Yes	Yes	Yes	Yes	Yes	Yes	Yes
PA1	Yes	Yes	Yes	Yes	Yes	Yes	Yes
PA2	Yes	Yes	Yes	Yes	Yes	Yes	Yes
PA3	Yes	Yes	Yes	Yes	Yes	Yes	Yes
PA4	Yes	Yes	Yes	Yes	Yes	Yes	Yes
PA5	Yes	Yes	Yes	Yes	Yes	Yes	Yes
PA6	Yes	Yes	Yes	Yes	Yes	Yes	Yes
PA7	Yes	Yes	Yes	Yes	Yes	Yes	Yes
PA8	Yes	Yes	Yes	Yes	Yes	Yes	Yes
PA9	Yes	Yes	Yes	Yes	Yes	Yes	Yes
PA10	Yes	Yes	Yes	Yes	Yes	Yes	Yes
PA11	Yes	Yes	Yes	Yes	Yes	Yes	Yes
PA12	Yes	Yes	Yes	Yes	Yes	Yes	Yes
PA13	Yes	Yes	Yes	Yes	Yes	Yes	Yes
PA14		SPECIAL		SPECIAL			SPECIAL
PA15	SPECIAL		SPECIAL		SPECIAL		

 **Note**

SPECIAL - please see I²C section.

4.5. SPI

There are 3 user-configurable SPI channels available for mapping to GPIO, for use by the user for the target application. All 3 SPI channels are Master only, and cannot be configured to be slaves at this time.

The SPI Bus speed is configurable using the **SPIx_Init()** Function in 4DGL and allows various speeds from 78.125Khz to 17.5Mhz.

Please refer to the [table](#) for details on which GPIO can be configured for SPI.

Note

The additional SPI channel (SPI0) is dedicated to the memory cards and cannot be reconfigured for alternate uses.

To map an SPI channel to a set of GPIO pins, the following 4DGL functions are used:

- **SPIx_SCK_pin(pin);** // Map the SCK pin
- **SPIx_SDI_pin(pin);** // Map the SDI pin
- **SPIx_SDO_pin(pin);** // Map the SDO pin

where:

'SPIx' is substituted with SPI1, SPI2 or SPI3 accordingly, and

'pin' is the target GPIO pin compatible with that particular pin function.

Chip Select for use with SPI can be any other unused GPIO pin, configured as a Digital Output. The lowering and raising of the selected CS (GPIO) pin is done manually by the user in the 4DGL application.

Please refer to the [Diablo16 Internal Functions Manual](#) datasheet for more information on how to use the SPI functions, along with the [DIABLO16-Processor](#) datasheet.

4.6. I2C

There are 3 user-configurable I2C channels available for mapping to GPIO, for use by the user for the target application. All 3 I²C channels are Master only, and cannot be configured to be slaves at this time.

Please refer to the [table](#) for details on which GPIO can be configured for I²C.

To map an I²C Channel to a set of GPIO pins, the following 4DGL function is used:

· **I2Cx_Open(Speed, SCLpin, SDApin);**

where:

'I2Cx' is substituted with I2C1, I2C2 or I2C3 accordingly,

'Speed' is the desired I2C Bus speed, and

'SCLpin' and 'SDApin' are the target GPIO pins compatible with that particular pin function.

Note

The normal I²C pins are PA0 to PA13, however, the use of these pins has a few limitations.

1. There is no slew rate control at I2C_MED.
2. I2C_FAST is not truly 1MHz.

If either of these restrictions needs to be addressed, a special case of SCLpin = PA14 and SDApin = PA15 exists ONLY for speeds I2C_MED (which uses slew rate control) and I2C_FAST (which is truly 1MHz)

Please refer to the [Diablo16 Internal Functions Manual](#) datasheet for more information on how to use the I²C functions, along with the [DIABLO16-Processor](#) datasheet.

4.7. Pulse Out

Pulse Out is used to create a single pulse of set duration on the selected pin of choice, which is inverted in polarity to the current state of the pin.

This '*inversion of polarity*' means if a Pin is currently held HI, and Pulse Out is executed on that Pin, the pin will pulse LO and then return to HI. Same with vice versa, if currently LO and Pulse Out are executed on that Pin, it will pulse HI and then return to LO.

This is available in both blocking and non-blocking versions.

Please refer to the [table](#) for details on which GPIO can be configured to Pulse Out.

Note

Each Pulse Out request needs at least a 1ms lead time due to the scheduling of the event with the internal 1ms timer.

To enable the Pulse Out function on a GPIO pin, the following 4DGL functions are used:

- **pin_Pulseout(pin, value);** //Non-Blocking
- **pin_PulseoutB(pin, value);** //Blocking

where:

'pin' is the target GPIO pin compatible with that particular pin function, and

'value' is the length of the pulse in milliseconds.

Please refer to the [Diablo16 Internal Functions Manual](#) datasheet for more information on how to use the Pulse Out functions, along with the [DIABLO16-Processor](#) datasheet.

4.8. PWM Out

There are 6 PWM channels available to be configured by the user, with 4-time bases available for selection. The PWM can be configured to be used in Servo Mode, or Simple Mode.

Please refer to the [table](#) for details on which GPIO can be configured to PWM.

Servo Mode allows a millisecond input value with 0.01ms resolution, which runs at a frequency of approximately 50Hz or 50pps (20ms). The position of the servo is determined by the width of the pulse. Generally, 1.5ms is 90 degrees, 1ms is 0 degrees and 2ms is 180 degrees. Servos however vary, and the DIABLO16 PWM control can be adjusted to suit most applications.

Simple Mode allows a percentage input value with a resolution of 0.1%, which runs at a frequency of approximately 70KHz.

To enable the PWM output on a GPIO pin, the following 4DGL function is used:

· **PWM_Init(pin, mode, value);**

where:

'pin' is the GPIO compatible with the particular pin function,

'mode' is the type of PWM to generate, and

'value' is the parameter that defined the PWM pulse itself.

Please refer to the [Diablo16 Internal Functions Manual](#) datasheet for more information on how to use the PWM functions, along with the [DIABLO16-Processor](#) datasheet.

4.9. Pin Counter

There are 6 Pin Counter channels available to be configured by the user, used to count incoming pulses with the ability to call a user function on overflow. The Pin Counter function is available for use in a variety of modes.

The counters can be read and written at any time.

Please refer to the [table](#) for details on which GPIO can be configured to Pin Counter.

To enable the Pin Counter function on a GPIO pin, the following 4DGL function is used:

· **pin_Counter(pin, mode, OVFunction);**

where:

'pin' is the GPIO pin compatible with this particular function,

'mode' is the type of trigger used to count on such as Rising/Falling/Edge, and

'OVFunction' is the user function to call when the counter overflows if desired.

Please refer to the [Diablo16 Internal Functions Manual](#) datasheet for more information on how to use the Pin Counter functions, along with the [DIABLO16-Processor](#) datasheet.

4.10. Quadrature In

There are two Quadrature Input channels available on the DIABLO16 processor, which requires 2 GPIO pins each.

Please refer to the [table](#) for details on which GPIO can be configured for Quadrature Input.

Quadrature Input allows a quadrature encoder to be connected, and the position counter and delta counter can be read at any time.

To enable the Quadrature Input function on a set of GPIO pins (2 pins required), the following 4DGL function is used:

· Qencoderx(PHApin, PHBpin, mode);

where:

'Qencoderx' is substituted for Qencoder1 or Qencoder2 accordingly,

'PHApin' is the pin connected to the A Phase of the Encoder,

'PHBpin' is the pin connected to the B Phase of the Encoder, and

'mode' is not currently used so is to be set to zero (0).

Please refer to the [Diablo16 Internal Functions Manual](#) datasheet for more information on how to use the Quadrature Input functions, along with the [DIABLO16-Processor](#) datasheet.

4.11. Analog Inputs

Please refer to the [table](#) under the [General Purpose I/O](#) section for details about pins you can configure to analog inputs.

The analog inputs on the DIABLO16 have a range of 0V to 3.3V, each with a max resolution of 12 bits. You can read the analog inputs using either the standard mode, averaged mode or high-speed mode.

- **Standard Mode** results are immediately read in a sample. Standard Mode can read over 40000 values per second. Operates at 12-bit.
- **Averaged Mode** results are immediately read in 16 samples and their average is returned. Averaged Mode can read ~20000 values per second. Operates at 12-bit.
- **Highspeed Mode** collects a user-specified number of samples at a user-specified rate/frequency and can execute a user function when complete. The updated value updates ~250000 times across 1-4 channels. Operates at 10-bit.

To enable a GPIO as an Analog Input for Standard or Averaged modes, you must use the following 4DGL function to set the pin :

- **pin_Set(mode, pin);**

where:

'mode' is the desired mode defined above, either Standard or Averaged, and

'pin' is the GPIO compatible with this function which is to become an Analog Input.

For highspeed mode, you must use the following 4DGL function to set the pin and define the parameters:

- **ana_HS(rate, samples, 1buf, 2buf, 3buf, 4buf, func);**

where:

'rate' is the number of samples per second,

'samples' is the number of samples to collect per channel,

'1buf' to '4buf' are the buffer addresses for the 4 channels, and

'func' is the user function to call when the number of samples specified has been collected.

Please refer to the [Diablo16 Internal Functions Manual](#) for more information on how to use the Analog Input functions, along with the [DIABLO16-Processor](#) datasheet.

Note

Analog Inputs are 0V-3.3V tolerant only. Do not apply voltages outside of this range as you will damage Diablo16.

5. Module Features

The gen4 series of Integrated Display Modules are designed to accommodate most applications. Some of the main features of the module are listed below.

5.1. DIABLO16 Processor

The module is designed around the DIABLO16 Graphics Controller from 4D-Labs.



The DIABLO16 is a smart Controller and the interface to the TFT-LCDs is almost plug-n-play.

All of the data and control signals are provided by the chip to interface directly with the display.

Powerful graphics, text, images, animation and countless more features are built right inside the chip.

You can refer to the [DIABLO16 graphics processor datasheet](#) for more information.

5.2. Audio

Audio playback support in the DIABLO16 Processor enables this module to play audio WAV files stored in the micro-SD memory card. Filtered PWM audio is generated and made available on the AUDIO pin of the 30-way ZIF connector, ready to interface with an audio amplifier on your application board.

A simple instruction enables the user to play/pause/stop audio files while continuing the execution of the user application code, such as display updates, touch recognition, communications, etc. The audio system also allows real-time pitch change of audio samples.

For a complete list of audio commands please refer to the separate document titled:

- [DIABLO16 4DGL Internal Functions](#)

5.3. SD/SDHC Memory Cards

The Diablo16 processor uses off-the-shelf standard SDHC/SD/microSD memory cards with up to 2GB capacity usable with FAT16 formatting. For any FAT file-related operations, before the memory card can be used it must first be formatted to FAT16. The formatting of the card can be done on any PC system with a card reader. Select the appropriate drive and choose the FAT16 (or just FAT in some systems) option when formatting. The card is now ready to be used in the Diablo16-based application.

The Diablo16 processor also supports high-capacity HC memory cards (4GB and above). The available capacity of SD-HC cards varies according to the way the card is partitioned and the commands used to access it.

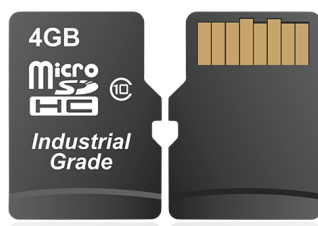

The FAT partition is always first (if it exists) and can be up to the maximum size permitted by FAT16. Windows 7 will format FAT16 up to 4GB. Windows XP will format FAT16 up to 2GB and the Windows XP command prompt will format FAT16 up to 4GB.

RMPET, a 4D Systems Tool found in the Workshop4 IDE, is capable of repartitioning and formatting microSD cards to be the appropriate type and format for 4D Systems processors. This tool should be used for all cards.

Note

1. An SPI Compatible SDHC/SD/microSD card **MUST** be used. Diablo16 along with other 4D Systems Processors requires SPI mode to communicate with the SD card. If a non-SPI compatible SD card is used, then the processor will not be able to mount the card.
2. Read disturbance is a well-known issue with flash memory devices, such as microSD cards, where reading data from a flash cell can cause the nearby cells in the same memory block to change over time. This issue can be prevented by using industrial-grade microSD cards with read disturb protection. Industrial-grade microSD cards have firmware that actively monitors the read operation and refreshes areas of memory that have high traffic and even move data around to prevent read disturb error from occurring. Furthermore, manufacturers may choose to implement read disturb protection on a specific part of the flash memory only, such that the beginning part of the memory might not be protected. The RMPET utility in Workshop4 is designed to create the first partition at an offset from the start of the microSD card to account for this situation. It is therefore recommended to always partition and format an industrial microSD card using the RMPET utility before using it with 4D Systems processors. Many commercial grade cards designed for Cameras etc, do not handle read disturb well at all, and therefore it is always recommended to use an Industrial grade microSD card with 4D modules. 4D offers one that is tried and tested, on our website.

5.4. FAT16

All 4D Systems display modules featuring 4D Labs processors use off-the-shelf standard SDHC/SD/micro-SD memory cards (SPI Compatible Only) with up to 4GB capacity usable with FAT16 formatting.

For any FAT file-related operations, before the memory card can be used it must first be formatted correctly. Built into Workshop4 is a tool created by 4D, called RMPET (please refer to the Tools menu, in any Environment, inside the Workshop4 IDE). RMPET allows the User to easily partition and format microSD cards, to make their file system ready to be used with 4D Systems modules. The formatting of the card can be done on any PC system with a card reader.

The DIABLO16 Processor also supports high-capacity HC memory cards (4GB and above). The available capacity of SD-HC cards varies according to the way the card is partitioned and the commands used to access it. Refer to the 4D Systems RMPET tool in the Workshop4 IDE.

A Max of 4GB can be utilised by the FAT16 file system. The FAT partition is always first (if it exists). Any space larger than 4GB will be RAW, and can still be utilised by your 4D Systems module, using different functions. Please refer to the [Application Notes](#).

5.5. Application PCB Support

The gen4 4.3" Diablo16 Integrated Display Module is designed to accommodate a range of applications and therefore is suited for those wanting to make a customised module, without the need for piggy-back or daughter boards mounted on headers.

On the back of the gen4 module, the display-related circuitry will be found, which is recessed into plastic. The level of the plastic on the back of the gen4 module is higher than the tallest component on the display circuit PCB, meaning an Application PCB can be mounted on the back of the gen4, without affecting the display-related circuitry.

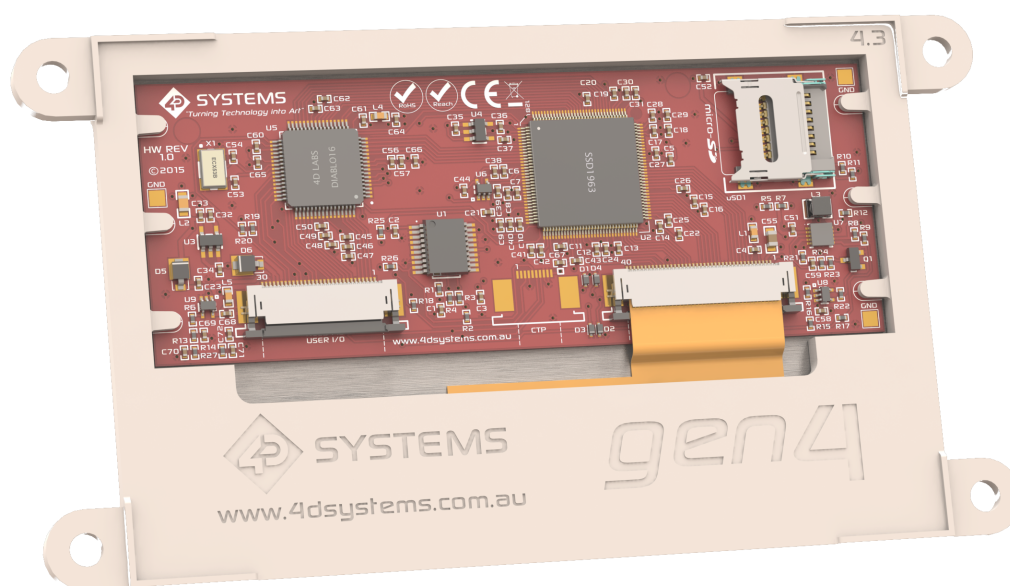

The image below shows a mock Application PCB on the back of the gen4 display (Blue area). It features a cut-out in the PCB so access to the micro-SD socket on the gen4's display board is possible, however, this may or may not be required depending on the application and if the micro-SD socket is utilised or requiring access once the Application PCB is applied.

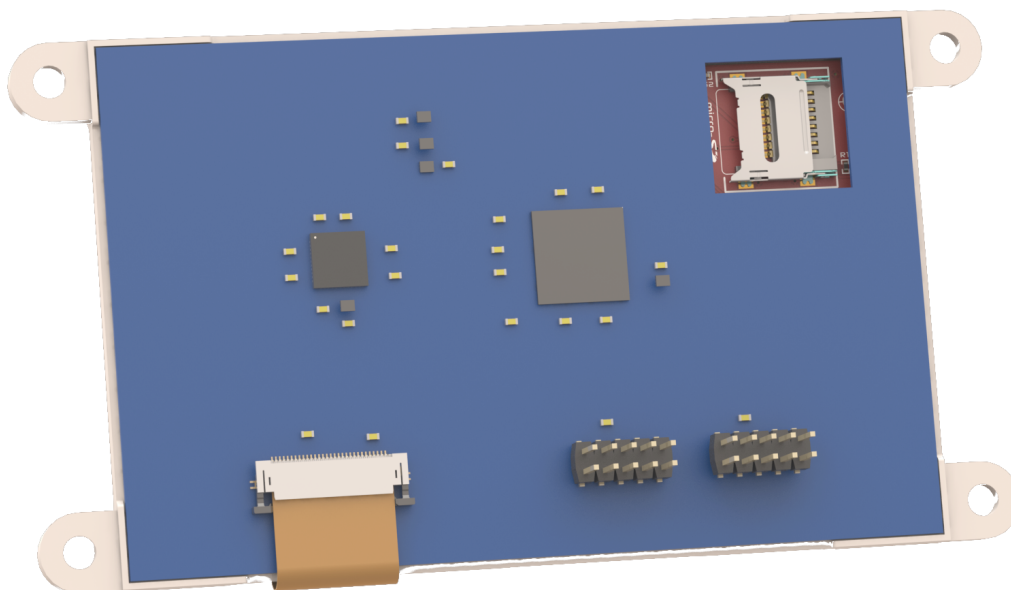

The 30-way FFC flex cable out of the gen4 into the application board can either turn up through a slot in the application board or can travel down under the gen4 plastic and emerge at the bottom and then into the application board (as depicted above).

The micro-SD socket is a latch type, so it is accessible from the top, rather than a push/push or push/pull style which is accessible from the side.

5.6. RF / EMI Shielding Support

As per what is written in section 5.5 (Application PCB Support), there is an option for extended RF shielding and EMI protection on this module.

On the back of the gen4's display PCB, are grounded plated 'X pads', which make contact with the metal housing of the display.

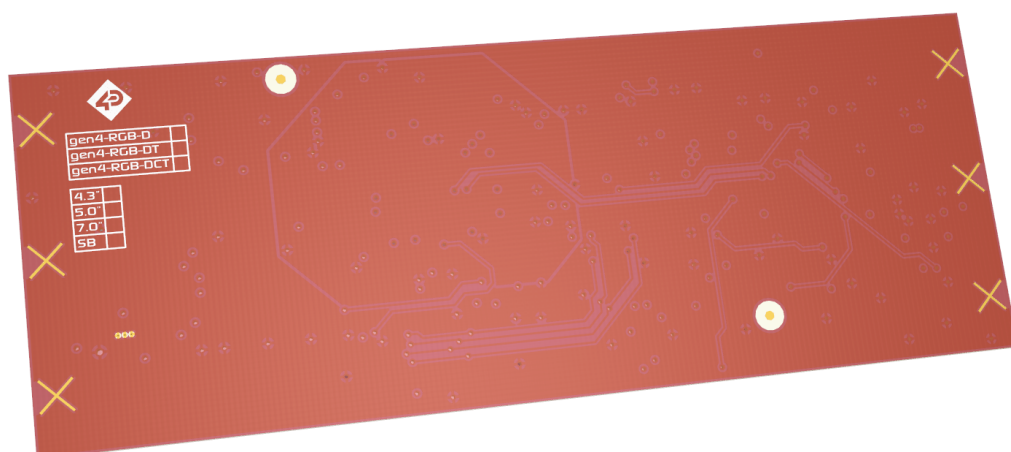

Where the Application PCB is shown to sit in under the **Application PCB Support** section; can house a small metal shield of the same size. This shield is used instead of, or underneath an Application PCB, to aid the onboard electronics in the prevention of potential RF or EMI signals.

On the top of the display, PCB is more GND pads, which can have a pogo pin or similar device mounted on them, which can make contact with this metal shield.

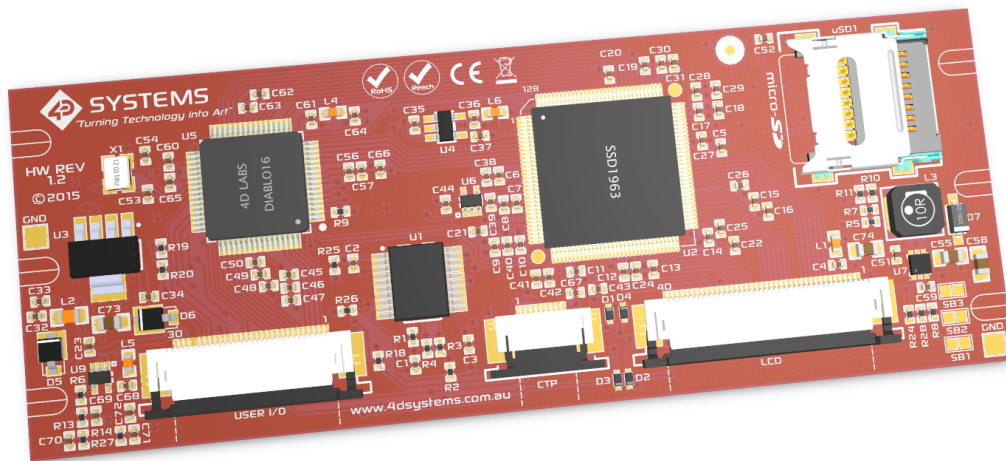

The display electronics are then sandwiched between the display's metal housing, and the metal shield, all connected with a common ground.

Note

There are no guarantees these steps will increase chances or grant access to EMI-related certifications. However, the gen4 can utilise shielding of the module's electronics, should the need arise. This may or may not assist the User with protecting the device against EMI/EMF/RF type noise, depending on the source, strength and type of noise present, but it should aid in the protection. 4D Systems do not make nor stock these, this is an example only, which could be trialed.

6. Display/Module Precautions

- Avoid having to display the same image/object on the screen for lengthy periods. This can cause a burn-in which is a common problem with all types of display technologies. Blank the screen after a while or dim it very low by adjusting the contrast. Better still; implement a screen saver feature.
- Moisture and water can damage the display. Moisture on the surface of a powered display should not cause any problems, however, if water is to enter the display either from the front or from the rear, or come in contact with the PCB, it will damage. Wipe off any moisture gently or let the display dry before usage. If using this display module in an environment where it can get wet, ensure an appropriate enclosure is used.
- Dirt from fingerprint oil and fat can easily stain the surface of the display. Gently wipe off any stains with a soft lint-free cloth.
- The performance of the display will degrade under high temperatures and humidity. Avoid such conditions when storing.
- Do not tamper with the display flex cable that is connected to the control board. This may affect the connection between the display and the driving circuitry and cause failure.
- Displays are susceptible to mechanical shock and any force exerted on the module may result in deformed zebra stripes, a cracked display cell and a broken backlight.
- Always use the mounting holes on the module's corner plates to mount the display where possible.
- Display modules have a finite life, which is typically dictated by the display itself, more specifically the backlight. The backlight contains LEDs, which fade over time. In the [Specifications section](#) is a figure for the typical life of the display, and the criteria are listed. The resistive Touch model features a touch-sensitive film over the display which is sensitive to pressure. When mounting the display module in an enclosure, you should not apply pressure to the surface of the display by the enclosure. It could result in false touches or the touch will simply not function at all.

7. Hardware Tools

The following hardware tools are required for full control of the gen4 Integrated Display Modules.

7.1. 4D-UPA Programming Cable/Adaptor

The 4D programming interfaces are used to program a new Firmware/PmmC, Display Driver and for downloading compiled 4DGL code into the processor. They even serve as an interface for communicating serial data to the PC.

The 4D Programming Cable is a USB to Serial-TTL UART converter cable incorporating the Silabs CP2102 USB to Serial UART bridge IC.



4D Programming Cable

Note

In conjunction with a Programming Cable or a Programming Adaptor, the gen4 series of Display Modules require a simple interface board (gen4-IB), as there is no 5-way male header on gen4 modules like other 4D Systems modules.

gen4 Interface boards (gen4-IB) ship with each gen4 Display Module unless otherwise stated. Simply connect the supplied 30-way FPC cable to the ZIF connector on the gen4 Interface Board, and connect the Programming Cable or Adaptor to the 5-way header on the Interface Board. You are now ready to program using a 4D Programming Cable. This can also be used to interface with other devices such as a 4D Arduino Adaptor Shield, breadboard etc.

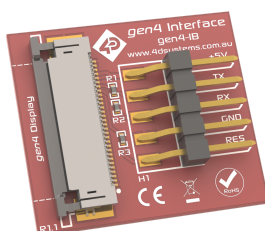

An alternative to using a gen4-IB and a 4D Programming Cable is a single all-in-one board called the 4D-UPA (4D Universal Programming Adaptor).

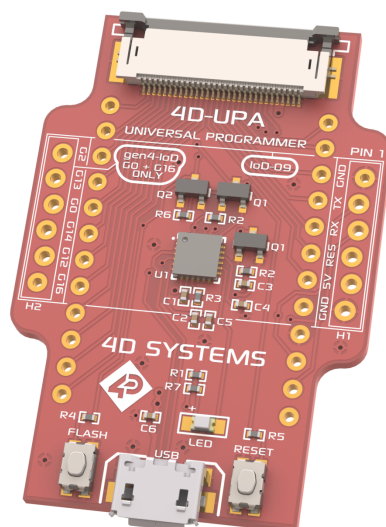

4D-UPA

The 4D-UPA minimizes the connections and modules required for programming - creating a single module with a micro USB interface, and DIP style pads for GPIO breakout of all the signals used on the gen4 Display interface, which is useful for development or final product use.

The GPIO naming convention on the 4D-UPA does not reflect the GPIO naming of the actual display module, due to the 4D-UPA being universal and able to be used with many 4D Products. Please review the 4D-UPA datasheet for information on mapping the GPIO naming from this module, with the GPIO naming on the 4D-UPA, to ensure you connect to the correct pins you desire.

Note

In addition to these modules, the [gen4-PA](#) and [uUSB-PA5/uUSB PA5-II](#) can still be used. Please be reminded though that the uUSB-PA5/PA5-II still needs a gen4-IB to be used for programming.

Using a non-4D programming interface could damage your processor, and **void your warranty**.

8. Programming Language

The DIABLO16 processor belongs to a family of processors powered by a highly optimised softcore virtual engine called EVE (Extensible Virtual Engine). EVE was designed and created by 4D Systems in the early 2000s, and should not be confused with FTDI's solution of EVE, which was developed a decent decade or so later.

EVE is a proprietary, high-performance virtual machine with an extensive byte-code instruction set optimised to execute compiled 4DGL programs.

4DGL (4D Graphics Language) was specifically developed from the ground up for the EVE engine core. It is a high-level language that is easy to learn and simple to understand yet powerful enough to tackle many embedded graphics applications.

4DGL is a graphics-oriented language allowing rapid application development, and the syntax structure was designed using elements of popular languages such as C, Basic, Pascal and others.

Programmers familiar with these languages will feel right at home with 4DGL. It includes many familiar instructions such as `IF..ELSE..ENDIF`,

`WHILE..WEND`, `REPEAT..UNTIL`, `GOSUB..ENDSUB`, `GOTO`, `PRINT` as well as some specialised instructions `SERIN`, `SEROUT`, `GFX_LINE`, `GFX_CIRCLE` and many more.

For detailed information pertaining to the 4DGL language, please refer to the following documents:

- [4DGL Programmers Reference Manual](#)
- [Diablo16 Internal Functions Manual](#)

To assist with the development of 4DGL applications, the Workshop4 IDE combines a full-featured editor, a compiler, a linker and a downloader into a single PC-based application. It's all you need to code, test and run your applications.

4DGL is available to be written in two of the four environments offered by the Workshop4 IDE, Designer and ViSi. The other two environments, Serial and ViSi-Genie do not directly use 4DGL by the User (Except in Workshop4 Pro, for ViSi-Genie), however, it is present in the background. Serial is an application that runs, and that is written in 4DGL. ViSi-Genie automatically generates 4DGL itself based on what is configured in the GUI. More information about each follows.

9. Workshop4 IDE

Workshop4 is a comprehensive software IDE that provides an integrated software development platform for all of the 4D family of processors and modules. The IDE combines the Editor, Compiler, Linker and Downloader to develop complete 4DGL application code. All user application code is developed within the Workshop4 IDE.

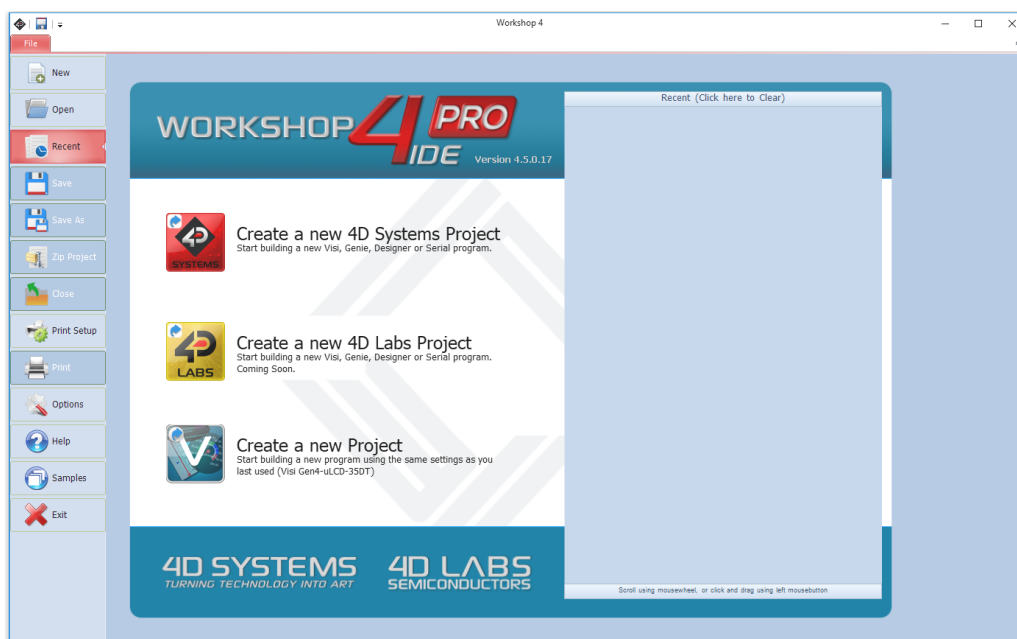

The Workshop4 IDE supports multiple development environments for the user, to cater to different user requirements and skill levels.

- The **Designer** environment enables the user to write 4DGL code in its natural form to program the range of 4D System's intelligent displays.
- A visual programming experience, suitably called **Visi**, enables drag-and-drop type placement of objects to assist with 4DGL code generation and allows the user to visualise how the display will look while being developed.
- An advanced environment called **Visi-Genie** doesn't require any 4DGL coding at all, it is all done automatically for you. Simply lay the display out with the objects you want, set the events to drive them and the code is written for you automatically. This can be extended with additional features when a Workshop4 PRO license is purchased from the 4D Systems website. Extended Advanced features for Visi-Genie are available in the PRO version of WS4. Further details are explained in the [Visi Genie](#) section of the Workshop4 documentation.
- A **Serial** environment is also provided to transform the display module into a slave serial module, allowing the user to control the display from any host microcontroller or device with a serial port.

For more information regarding these environments, refer to the [Workshop4 manuals](#).

The Workshop 4 IDE is available from the [4D Systems website](#).

9.1. PmmC Programming

The DIABLO16 processor is a custom graphics processor. All functionality including the high-level commands is built into the chip. This chip-level configuration is available as a PmmC (Personality-module-micro-Code) file, which can be likened to traditional Firmware. There is also a Display Driver file, which separates specific display settings from the PmmC, unlike on the PICASO processor where everything is combined.

A PmmC file contains all of the low-level micro-code information (analogy of that of a soft silicon) which defines the characteristics and functionality of the device. The ability of programming the device with a PmmC file provides an extremely flexible method of customising as well as upgrading it with future enhancements.

The Display Driver contains the initialisation and parameters associated with the particular display that is to be connected to the DIABLO16 processor, along with product-specific settings and parameters which are required over and above what is found in the PmmC.

The PmmC file and Display Driver file can only be programmed into the device via the COM0 serial port with the aid of Workshop 4, the 4D Systems IDE software.

Solutions, which remove the need to use Workshop4 to program the display modules, are available for commercial customers requiring batch programming or production line programming. These solutions are practical for production staff and minimize the chance of unwanted or unauthorised modifications on the production line.

Three solutions come with the Workshop4 IDE, which can be separated for production line computers if required, **ScriptC**, **PmmC Loader** and **Program Loader**.

ScriptC is a command line interface that can be controlled from a Batch Script or similar, useful for repetitive loading or when controlled from an external application. Example scripts are provided, showing how to load PmmC, Display Drivers and Applications using a batch script.

Program Loader is a GUI interface designed to download Applications to either Flash or RAM, useful for testing or production loading, without the need for Workshop4 itself.

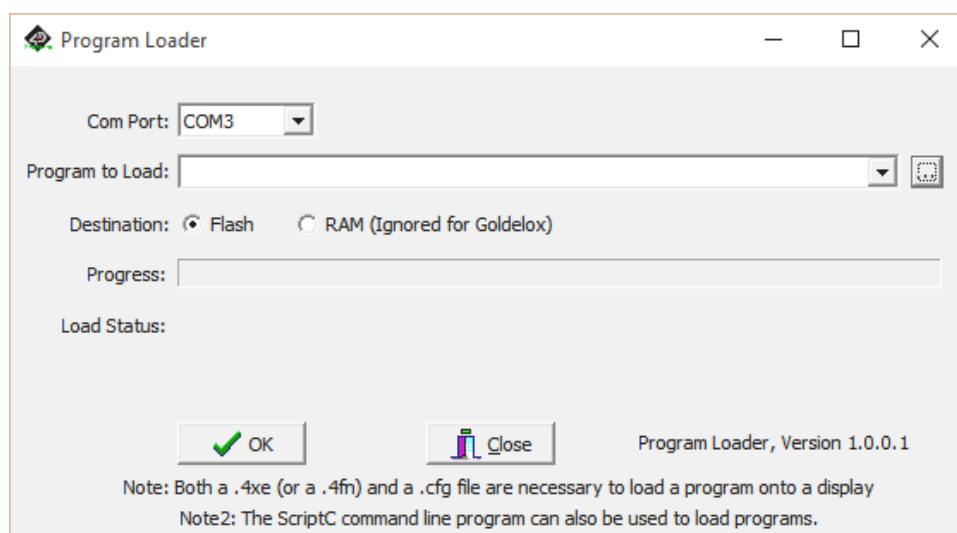

PmmC Loader is a GUI interface designed to download PmmC's and Drivers to 4D Systems Processors. It can automatically update existing PmmC's and Drivers present on a module, or manually change or force download to a blank processor or module, overwriting anything written in previously.

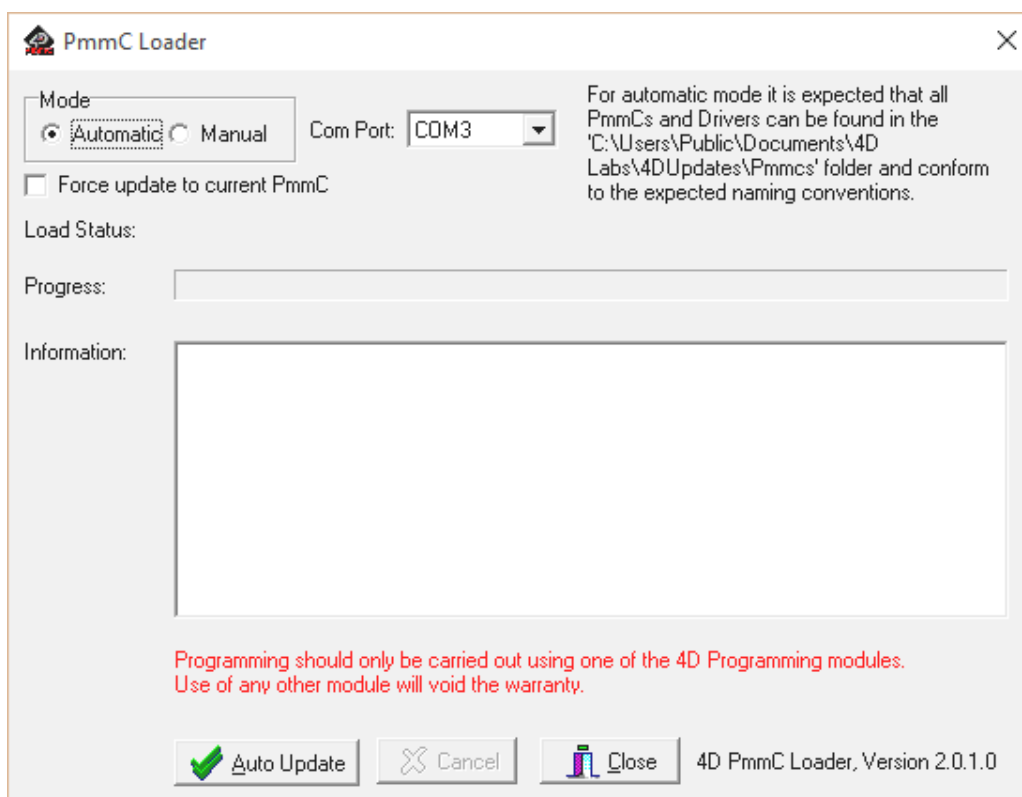

Please contact our Support Team for more information on what we can provide. Some solutions also exist for external processor-based loading, if there is a requirement for that. This solution is available under NDA. Using a non-4D programming interface could damage your module, and **void your warranty**.

10. Display Module Part Numbers

The following is a breakdown of the part numbers and what they mean.

Example:

· gen4-uLCD-43D-CLB-SB

where:

gen4 - gen4 Display Range

uLCD - microLCD Display Family

43 - Display size (4.3")

D - Diablo16 Processor

T - Resistive Touch

CT - Capacitive Touch

CLB - Cover Lens Bezel

SB - Super Bright Display



Note

- A product without a T or CT in the part number is a non-touch variant.
- Cover Lens Bezels (CLB) are glass fronts for the display module with overhanging edges, which allow the display module to be mounted directly into a panel using special adhesive on the overhanging glass. This is available for capacitive touch only.
- Resistive Touch models are not available in CLB, as a CLB is made of glass and resistive touch relies on the mechanical flexing of a membrane to trigger touch.

11. Cover Lens Bezel - Tape Spec

The perimeter of the CLB display modules features double-sided adhesive tape, designed to stick directly onto a panel, enclosure, box etc without the need for any mounting screws or hardware.

The tape used is 3M 9495LE tape, which uses well-known and strong 3M 300LSE adhesives. The double-sided adhesive has a thickness of 0.17mm once the backing has been removed.

More information on this adhesive can be found on the 3M website.

12. FFC Cable

The FFC cables supplied by 4D Systems (included with products) have the following specifications:

- **30 Pin** Flexible Flat Cable, 150mm Long, 0.5mm (0.02") pitch
- Cable Type: AWM 20624 80C 60V VW-1
- Heat Resistance 80 Degrees Celsius
- Connections on the opposite side at each end (Type B)

Note: You can get different cable lengths by contacting the 4D Systems sales team.

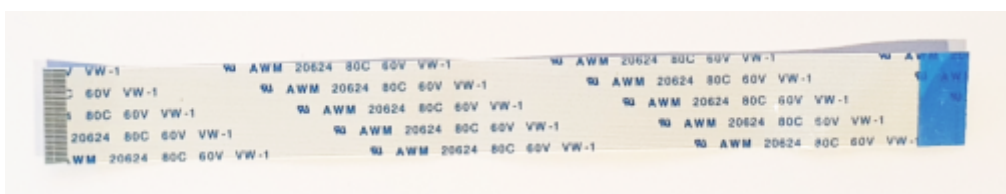

If you are interfacing with this module directly to your product, and wish to interface via the FFC cable directly, suitable connectors are readily available from many electronics suppliers, such as Digikey, Mouser, Farnell, RS, etc.

A standard 30-pin, 0.5mm pitch, 0.3mm thick FFC, FFC connector. They are available in Top Contact and Bottom Contact, so depending how you orientate the cable on your product, will determine which one you need. Please however take care of the pinout and how it flows from the display module, through the FFC and into your product, to ensure Pin1 and Pin30 are where you expect them to be.

13. Starter Kit

4D Systems highly recommends all first-time buyers of 4D Systems' displays, to purchase the Starter Kit when purchasing their first 4D Systems display solution.

The Starter Kit provides all the hardware that is required to get the User up and running.

Not all development environments and features will be needed by every User. However, purchasing the display solution in a Starter Kit allows you to take full advantage of all of the features of the 4D Systems Display Solution and try out each of the 4D Workshop4 Environments before settling with the preferred feature set.

The **Designer** environment can use every feature of the display, however, depending on the user requirements, a micro-SD (uSD) card may not be required. The uSD card is used when displaying images/video/sound, along with data logging to uSD, and a programming cable or adaptor is required for downloading compiled code and PmmC/Firmware updates.

The **ViSi** environment is the same as Designer in terms of feature utilisation, but is image based so requires a uSD card, along with a programming cable.

The **ViSi-Genie** environment is also image-based, and therefore requires a uSD card and programming cable also.

The **Serial** environment does not require either a uSD or Programming cable to be used once the module has been configured as a Serial device, however, can use both depending on the user's requirements. The uSD card can be used for such things as storage and display of multimedia files, data logging, and the Programming cable for PmmC/Firmware updates, or changing to one of the other three programming environments.

Starter Kits typically include:

- gen4 Integrated Display Module
- gen4 Interface Module (gen4-IB)
- 4D Universal Programming Adaptor (4D-UPA)
- 4GB micro-SD Card
- 5-way cable for easy connection to a breadboard or host via the gen4-IB
- 150mm 30-way FFC cable for connecting gen4 display to gen4-IB or 4D-UPA

Please refer to the [4D Systems website](#) for the current components included in the Starter Kit.

Simply select the Starter Kit option when purchasing the chosen display module on the 4D Systems shopping cart, or from your local distributor.

14. Mechanical Details (Non-Touch & Resistive Touch)

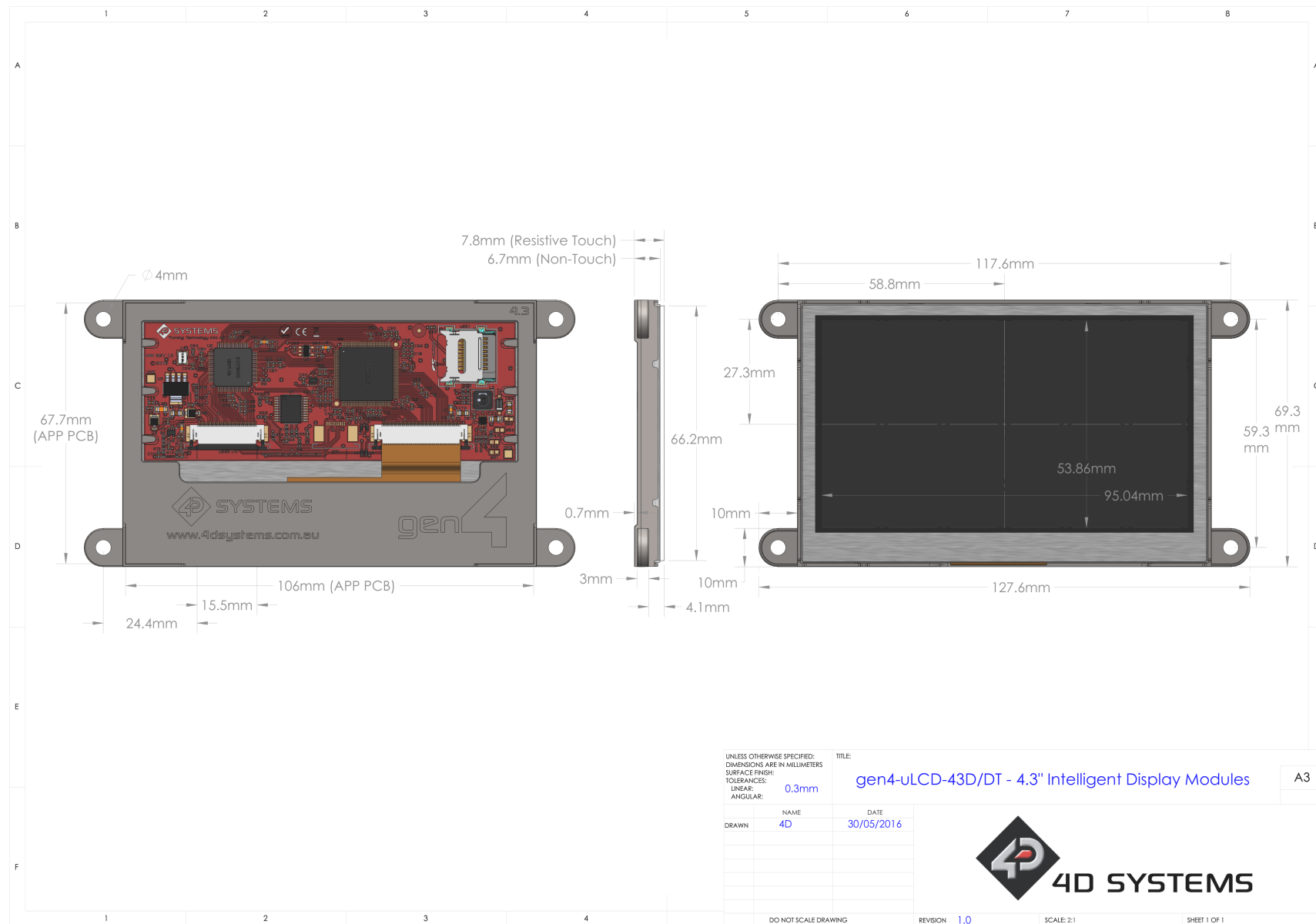

UNLESS OTHERWISE SPECIFIED: DIMENSIONS ARE IN MILLIMETERS		TITLE:	A3
SURFACE FINISH:		gen4-uLCD-43D/DT - 4.3" Intelligent Display Modules	
TOLERANCES: LINEAR: 0.3mm ANGULAR:			
DRAWN:	NAME: 4D	DATE: 30/05/2016	



15. Mechanical Details (Non-Touch CLB & Capacitive Touch CLB)



16. Mechanical Details (Capacitive Touch - Non-CLB)

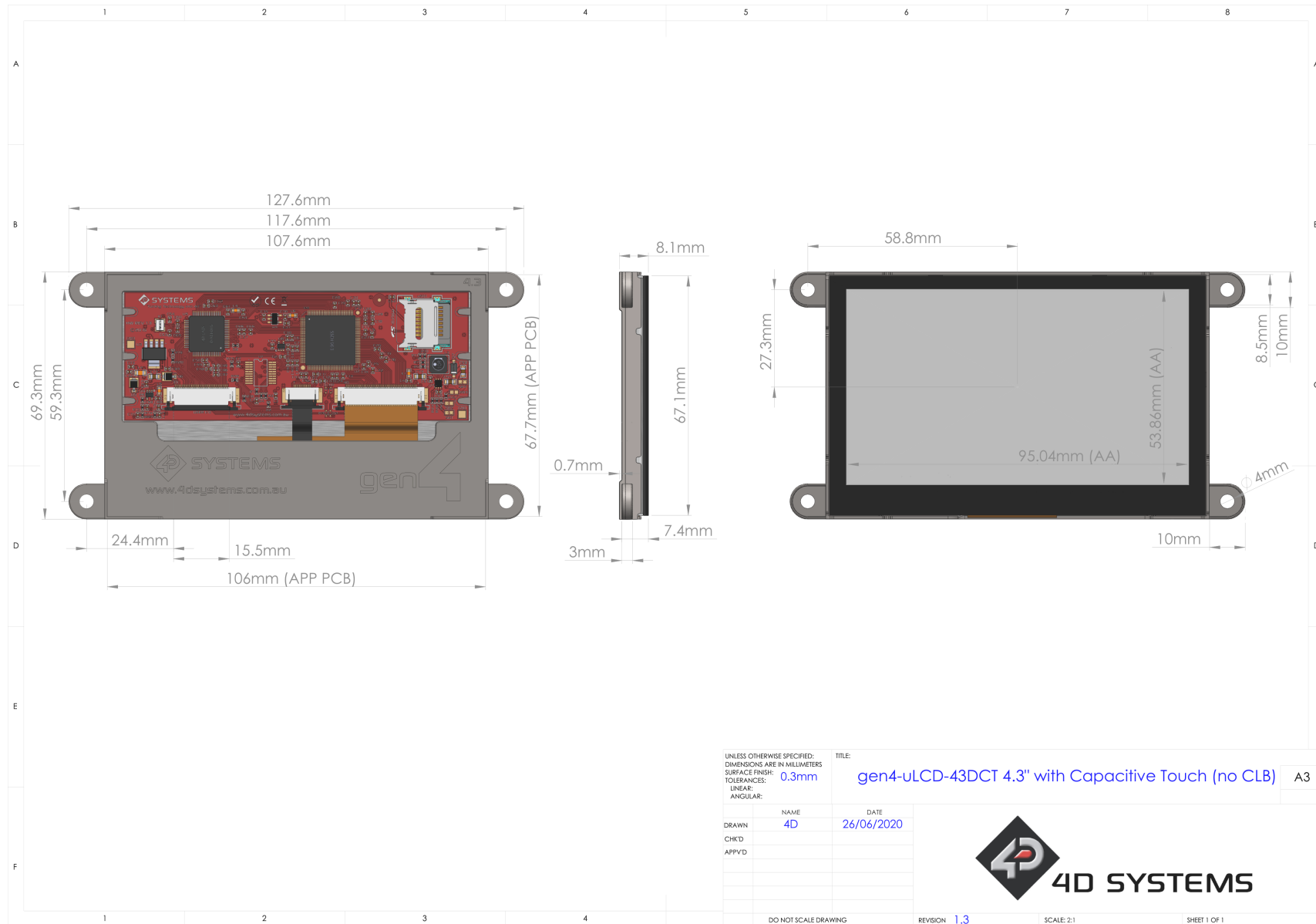

17. Schematic Details (HW REV 1.2)

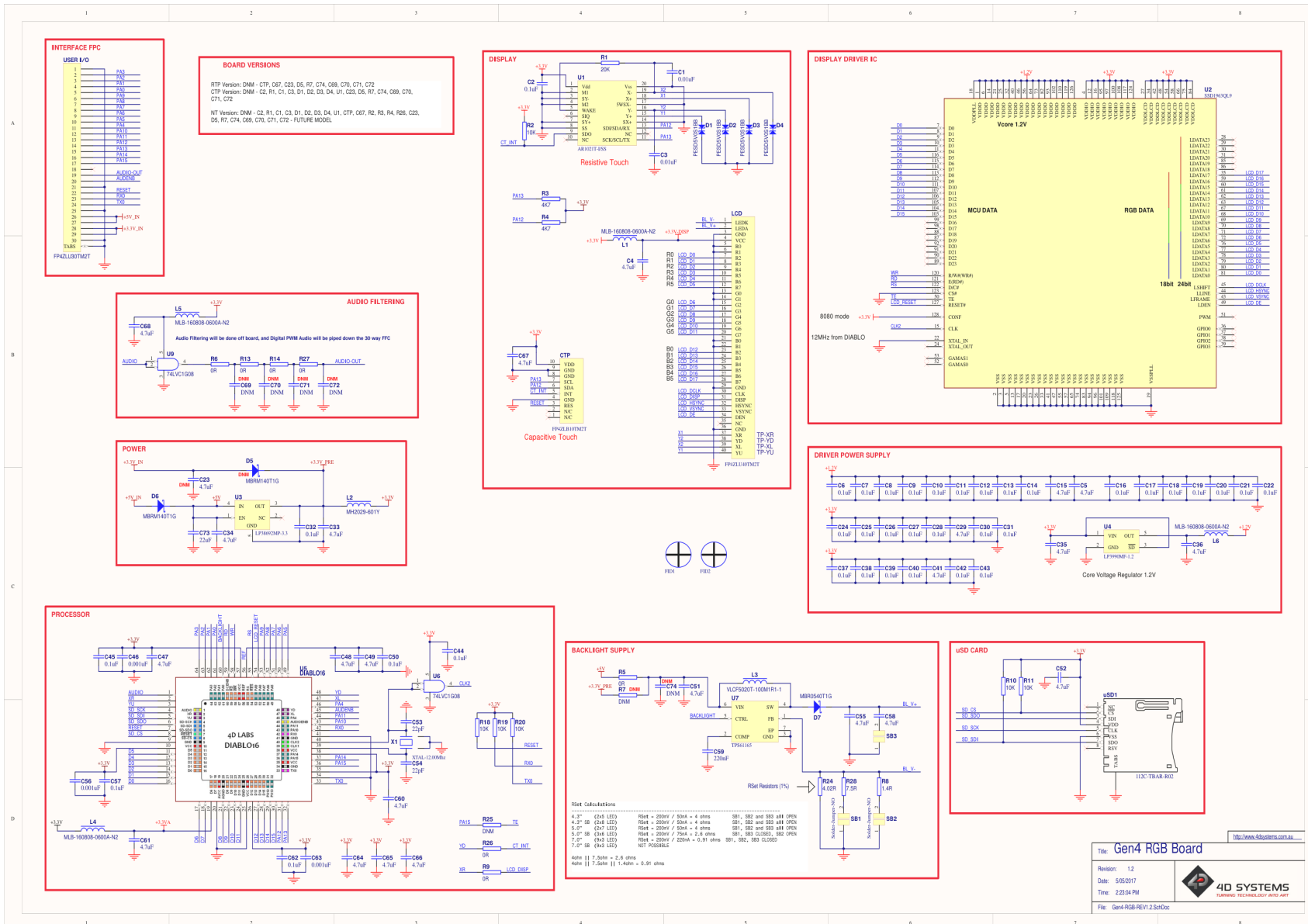

18. Schematic Details (HW REV 1.3)

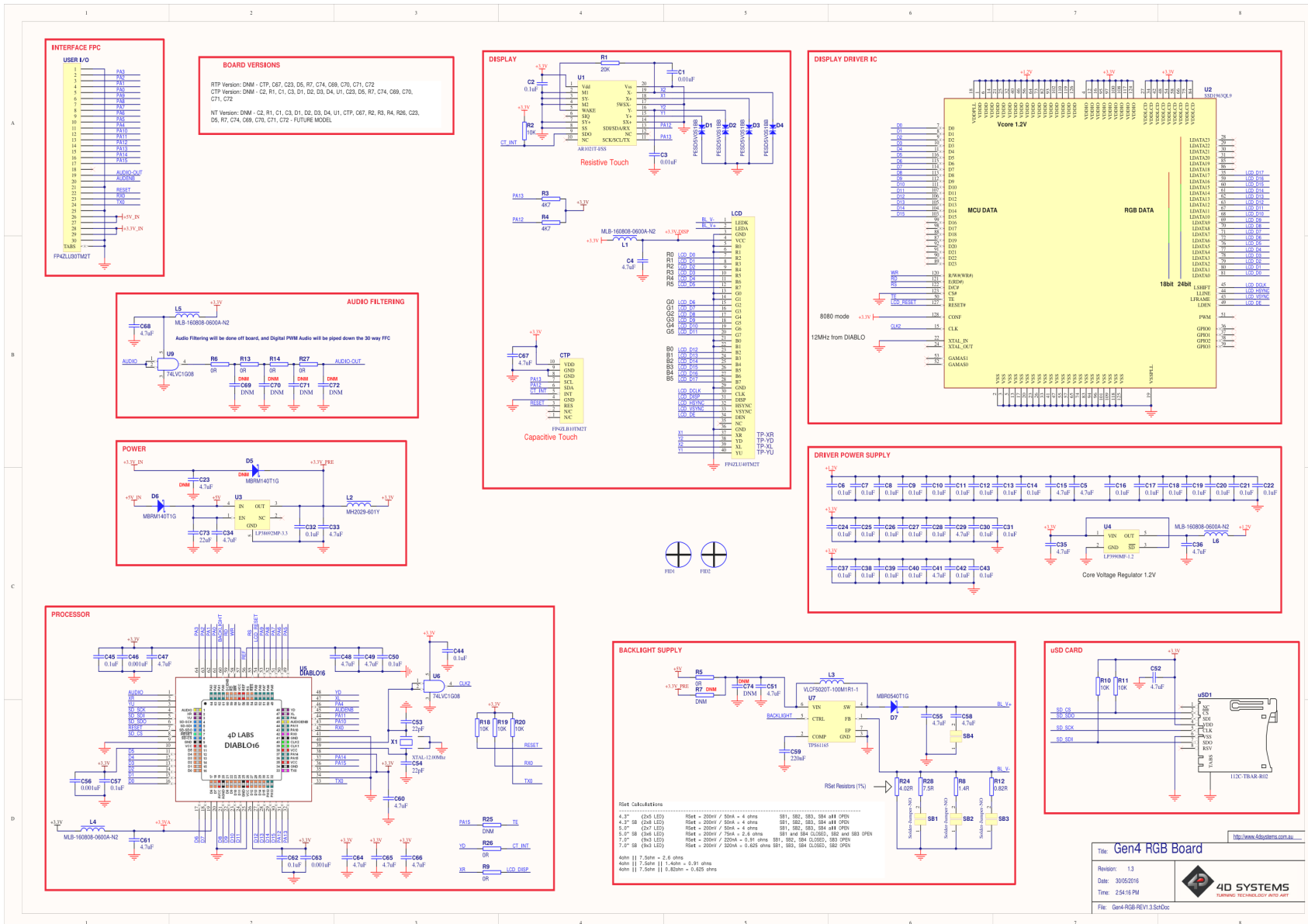

19. Schematic Details (HW REV 1.5)

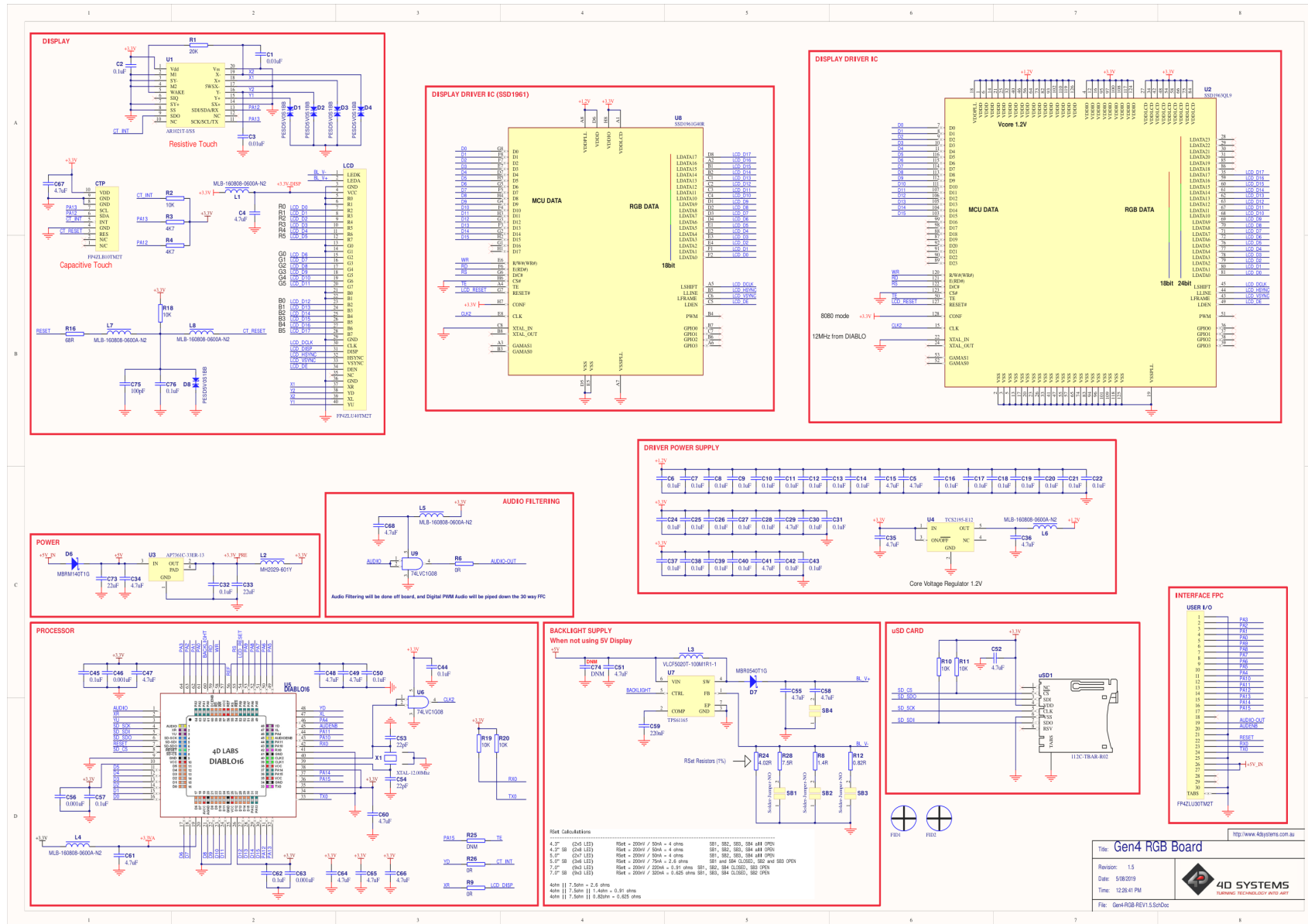

20. Schematic Details (HW REV 2.1)

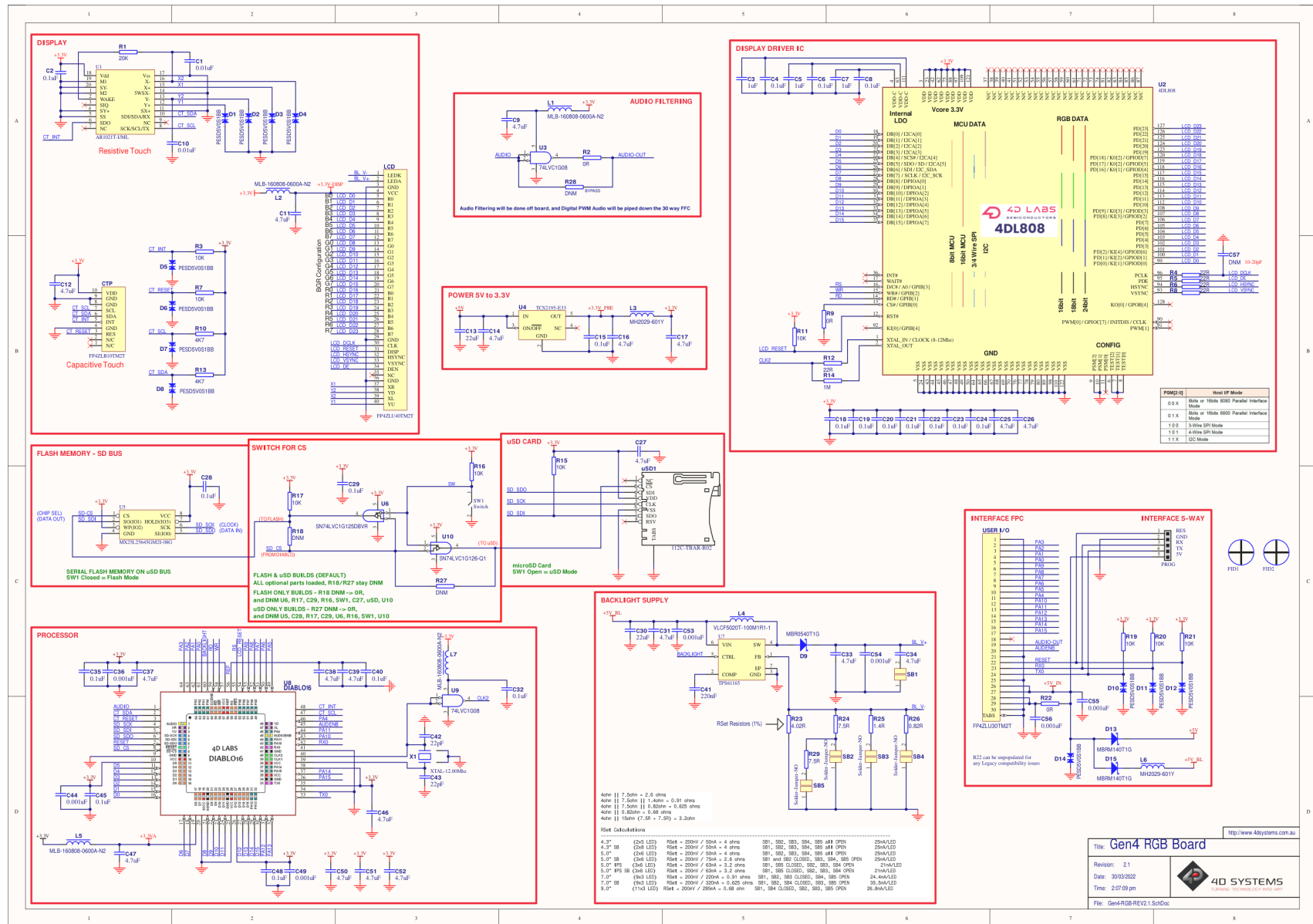

21. Specifications

Absolute Maximum Ratings

Operating ambient temperature	-20°C to +70°C
Storage temperature	-30°C to +80°C
Voltage on any digital input pin with respect to GND	-0.3V to 6.0V
Voltage on VCC with respect to GND	-0.3V to 6.0V
Maximum current sunk/sourced by any pin	10.0mA
Maximum current sunk/sourced by all ports	200.0mA

Note

Stresses above those listed here may cause permanent damage to the device. This is for stress rating only and functional operation of the device at those or any other conditions above those indicated in the recommended operation listings of this specification is not implied. Exposure to maximum rating conditions for extended periods may affect device reliability.

Recommended Operating Conditions

Parameter	Conditions	Min	Typ	Max	Units
Supply Voltage (VCC)	Stable external supply required	4.0	5.0	5.5	V
Processor voltage (VP)		--	3.3	--	V
Input Low Voltage (VIL)	all pins	0	--	0.2VP	V
Input High Voltage (VIH)	non 5V tolerant pins	0.8VP	--	3.3	V
Input High Voltage (VIH)	PA4-PA13, RX0 and TX0 pins	0.8VP	--	5.5	V
Reset Pulse	External Open Collector	2.0	--	--	μs
Operational Delay	Power-Up or External Reset	500	--	3000	ms

Global Characteristics Based on Operating Conditions

Parameter	Conditions	Min	Typ	Max	Units
Supply Current (ICC)	gen4-uLCD-43D (Contrast = 15)	--	310	--	mA
	gen4-uLCD-43D-CLB (Contrast = 15)	--	310	--	mA
	gen4-uLCD-43DT (Contrast = 15)	--	310	--	mA
	gen4-uLCD-43DCT-CLB (Contrast = 15)	--	315	--	mA
	gen4-uLCD-43DCT (Contrast = 15)	--	315	--	mA
	gen4-uLCD-43D-SB (Contrast = 15)	--	530	--	mA
	gen4-uLCD-43D-CLB-SB (Contrast = 15)	--	530	--	mA
	gen4-uLCD-43DT-SB (Contrast = 15)	--	530	--	mA
	gen4-uLCD-43DCT-SB (Contrast = 15)	--	540	--	mA
	gen4-uLCD-43DCT-CLB-SB (Contrast = 15)	--	540	--	mA
Display Endurance	Hours of operation, measured to when display is 50% original brightness	30000	--	--	H
Touch Screen Endurance (Resistive Touch)	Number of touches/hits with a 12.5mm tip at a rate of 2x per second with 250gf force	--	1M	--	Touches
	Slide stylus on screen, 100gf force, 60mm/s speed with a 0.8mm polyacetal tip stylus pen	--	100K	--	Slides
Touch Screen Transparency	Resistive Touch	82	--	--	%
	Capacitive Touch	90	--	--	%
Touch Screen Operational Force (Resistive Touch)	Only use Finger or Stylus, do not use anything sharp or metal	20	--	100	Gf
CLB Hardness	Cover Lens Bezel Glass Hardness	--	6	--	H

 **LCD DISPLAY INFORMATION (TN DISPLAY)**

Parameter	Conditions	Specification
Display Type	All displays produced before the IPS release date in the IPS table below, or any modules not specified are therefore TN type displays.	TN - TFT Transmissive LCD
Display Size		4.3" Diagonal
Display Resolution		480 x 272 (Landscape/Wide Viewing)
Display Brightness	gen4-uLCD-43D (Contrast = 15)	500 cd/m2
	gen4-uLCD-43D-CLB (Contrast = 15)	485 cd/m2
	gen4-uLCD-43DT (Contrast = 15)	400 cd/m2
	gen4-uLCD-43DCT (Contrast = 15)	475 cd/m2
	gen4-uLCD-43DCT-CLB (Contrast = 15)	475 cd/m2
	gen4-uLCD-43D-SB (Contrast = 15)	1020 cd/m2
	gen4-uLCD-43D-CLB-SB (Contrast = 15)	930 cd/m2
	gen4-uLCD-43DT-SB (Contrast = 15)	825 cd/m2
	gen4-uLCD-43DCT-SB (Contrast = 15)	880 cd/m2
	gen4-uLCD-43DCT-CLB-SB (Contrast = 15)	880 cd/m2
Display Contrast Ratio	Typical	500:1
Display Viewing Angles	Above Centre	70 Degrees
	Below Centre	60 Degrees
	Left of Centre	70 Degrees
	Right of Centre	70 Degrees
Display Viewing Direction		12 O'clock Display (Optimal viewing is from above when in Landscape/Wide mode)
Display Backlighting	gen4-uLCD-43Dxx-xxx Models	2x5 Parallel LED's
	gen4-uLCD-43Dxx-xxx-SB Models	2x8 Parallel LED's
Pixel Pitch		0.198 x 0.198 mm (Square pixels)
Pixel Density	Number of pixels in 1 row in 25.4mm	128 DPI/PPI

 **LCD DISPLAY INFORMATION (IPS DISPLAY)**

Parameter	Conditions	Specification
Display Type	gen4-uLCD-43D – Modules produced March 2021 onwards.	IPS - TFT Transmissive LCD
	gen4-uLCD-43DT – Modules produced March 2021 onwards.	
	gen4-uLCD-43DCT – Modules produced May 2020 onwards.	
	gen4-uLCD-43DCT-CLB – Modules produced March 2021 onwards.	
	gen4-uLCD-43DT-SB – Modules produced November 2020 onwards.	
	gen4-uLCD-43DCT-CLB-SB – Modules produced March 2021 onwards.	
Display Size		4.3" Diagonal
Display Resolution		480 x 272 (Landscape/Wide Viewing)
Display Brightness	gen4-uLCD-43D (Contrast = 15)	600 cd/m2
	gen4-uLCD-43DT (Contrast = 15)	510 cd/m2
	gen4-uLCD-43DCT (Contrast = 15)	540 cd/m2
	gen4-uLCD-43DCT-CLB (Contrast = 15)	540 cd/m2
	gen4-uLCD-43DT-SB (Contrast = 15)	825 cd/m2
Display Contrast Ratio	Typical	800:1
Display Viewing Angles	Above Centre	80 Degrees
	Below Centre	80 Degrees
	Left of Centre	80 Degrees
	Right of Centre	80 Degrees
Display Viewing Direction		ALL (wide viewing IPS Display)
Display Backlighting	gen4-uLCD-43Dxx-xxx Models	2x5 Parallel LED's
	gen4-uLCD-43Dxx-xxx-SB Models	2x8 Parallel LED's
Pixel Pitch		0.198 x 0.198 mm (Square pixels)
Pixel Density	Number of pixels in 1 row in 25.4mm	128 DPI/PPI

 **Note**

Relevant for both TN and IPS displays, the Displays used are of the highest rated 'Grade A', which allows for 0-4 defective pixels. A defective pixel could be solid Black (Dead), White, Red, Green or Blue.

22. Revision History

 Datasheet Revision		
Revision Number	Date	Description
0.1	01/01/2015	Internal Use Only
1.0	10/12/2015	Initial Public Release Version
1.1	22/12/2015	Cosmetic Changes to gen4 Datasheet range
1.2	13/06/2016	Drawing and Specification updates, other minor changes
1.3	28/09/2016	Addition of Super Bright variant information
1.4	05/05/2017	Addition of HW REV 1.2 and REV 1.3 schematics
1.5	17/10/2017	Addition of processor voltage information
1.6	04/03/2019	Cosmetic changes, revised description, removed clutters, added REV 1.5 schematic
1.7	05/08/2019	Updated the REV 1.5 schematic
1.8	11/11/2019	Updated details regarding Serial Port voltage tolerance
1.9	07/03/2020	Updated GPIO information
1.10	26/06/2020	Added gen4-uLCD-43DCT variant
1.11	30/06/2021	General updates/information.
		Addition of FFC cable/connector information. FFC Cable section .
		Added current/brightness listings for CTP (non-CLB) models, which are identical to the CTP-CLB model. Specifications section .
		Addition of IPS display information/specs. Specifications section .
		IPS displays started being used in production as TN stocks were used up. The change-over date varies for each touch type.
		<ul style="list-style-type: none"> - Non-Touch (D) models changed over to IPS in March 2021. - Resistive-Touch (DT) models changed over to IPS in January 2021. - Capacitive-Touch (DCT) models changed over to IPS in May 2020. - Capacitive-Touch with CLB (DCT-CLB) models changed over to IPS in March 2021. - Resistive-Touch Super-Bright (DT-SB) models changed over to IPS in November 2020. - Any other model not stated, is therefore still a TN display.
1.12	07/09/2021	Addition to display information/specs Specifications section .
1.13	30/11/2021	Capacitive Touch with CLB Super Bright (DCT-CLB-SB) model changed over to IPS in March 2021. (missed previously)
1.14	12/12/2022	Modified datasheet for web-based documentation. Added HW REV 2.1 Schematics