



Quality Products. Service Excellence.

Humidity and Temperature Control SKTH Series



Features

- Designed to provide both air temperature and humidity control as well as monitoring in electrical and electronic enclosures.
- Independently senses the relative humidity and temperature. Resistive and inductive loads (heaters or filter fans) can be switched.
- Highly effective in ATMs, parking control gates, ticket dispensers and traffic control systems where equipment is exposed to wide ranging outdoor elements.

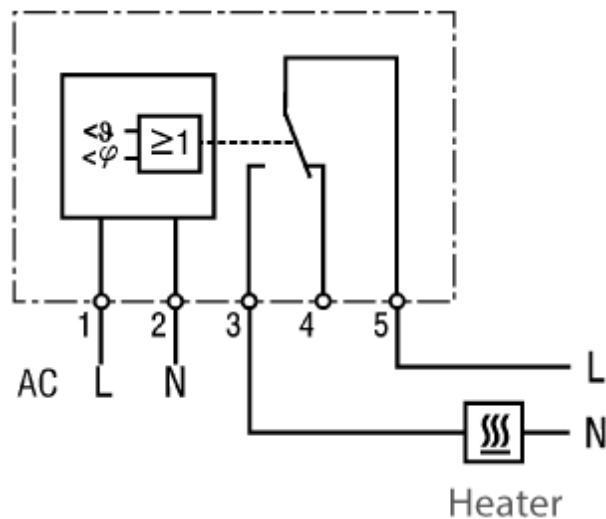

Part No.	Dimensions		Temperature Display	Operating Voltage
	Height x Width x Depth			
SKTH012009	3.0 x 2.4 x 1.77		+32 to + 140 F	100 - 240 VAC 50/60 Hz (min 90 V , max 265 V)
SKTH012009-C	3.0 x 2.4 x 1.77		0 to +60 C	100 - 240 VAC 50/60 Hz (min 90 V , max 265 V)

Switching Difference (temperature)	2K (+/- 1K at 25C (+77F) 50% RH)
Switching Difference (humidity)	4% RH (+/- 1K at 25C (+77F) 50% RH)
Setting range (humidity)	50 to 90% RH
Reaction time	aprox 5 sec
Contact type	Change over (relay)
Service life	NO/NC 30,000 cycles
Max Switching Relay output	10A Resistive / 1.6A inductive @ 240 VAC 0.6 @ 60 VDC
Max inrush current	AC 30 A for 10 sec
Case	Plastic UL 94V-O light Gray
Mounting	35 mm Din rail
Weight	3.5 oz . 100g
Protection	IP20
Approvals	UL file E164102 / UR componet / CE

© 2022. Hammond Manufacturing Ltd. All rights reserved.