

DATA SHEET

# SKY12208-306LF: 0.02 to 2.7 GHz 50 W High Power Silicon PIN Diode SPDT Switch

## Applications

- Transmit/receive and fail-safe switching in land mobile radios, public safety radios, and military communication systems

## Features

- High power handling: 50 W CW, 300 W peak
- Low insertion loss: 0.3 dB typical
- High isolation: 42 dB typical
- Controlled with positive power supply
- Bias driver circuit available on request
- Small, QFN (16-pin, 4 x 4 mm) Pb-free package (MSL1, 260 °C per JEDEC J-STD-020)



Skyworks Green™ products are compliant with all applicable legislation and are halogen-free. For additional information, refer to *Skyworks Definition of Green™*, document number SQ04-0074.

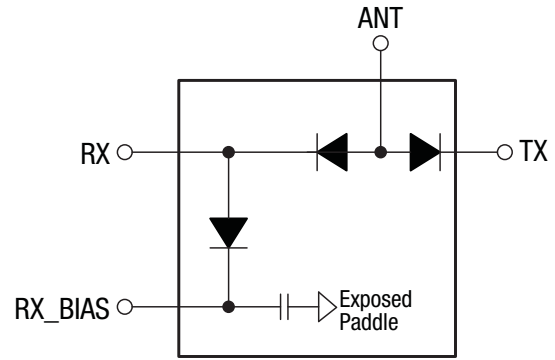

S2403

Figure 1. SKY12208-306LF Block Diagram

## Description

The SKY12208-306LF is a high power handling, Single-Pole, Double-Throw (SPDT) silicon PIN diode switch. The device can cover two frequency bands, 0.02 to 0.70 GHz or 0.05 to 2.7 GHz, by changing the value of an RF choke in the SMT bias network. The different Evaluation Board components for each band are noted in Table 10.

The SKY12208-306LF features low insertion loss, excellent power handling, and superb linearity with low DC power consumption. The device is well-suited for use as a high power transmit/receive switch in a variety of telecommunication systems.

The device is provided in a 4 x 4 mm, 16-pin Quad Flat No-Lead (QFN) package. A functional block diagram is shown in Figure 1. The pin configuration and package are shown in Figure 2. Signal pin assignments and functional pin descriptions are provided in Table 1.



Figure 2. SKY12208-306LF Pinout – 16-Pin QFN (Top View)

Table 1. SKY12208-306LF Signal Descriptions

Pin	Name	Description	Pin	Name	Description
1	GND	Ground. Must be connected to ground using lowest possible impedance.	9	RX_BIAS	RF ground port and DC bias input port
2	ANT	Antenna RF port and DC bias input port	10	N/C	No connection
3	GND	Ground. Must be connected to ground using lowest possible impedance.	11	N/C	No connection
4	N/C	No connection	12	N/C	No connection
5	N/C	No connection	13	GND	Ground. Must be connected to ground using lowest possible impedance.
6	GND	Ground. Must be connected to ground using lowest possible impedance.	14	TX	Transmit RF input port and DC bias input port
7	RX	Receive output port and DC bias input port	15	GND	Ground. Must be connected to ground using lowest possible impedance.
8	GND	Ground. Must be connected to ground using lowest possible impedance.	16	N/C	No connection

**Electrical and Mechanical Specifications**

The absolute maximum ratings of the SKY12208-306LF are provided in Table 2. Recommended operating conditions are specified in Table 3 and electrical specifications are provided in Table 4 (28 V bias @ 0.25 GHz), Table 5 (5 V bias @ 0.25 GHz), Table 6 (5 V bias @ 2.0 GHz), and Table 7 (28 V bias @ 2.0 GHz).

Typical performance characteristics of the SKY12208-306LF are illustrated in Figures 3 through 8 (0.25 GHz) and Figures 9 through 18 (2.0 GHz).

The state of the SKY12208-306LF is determined by the logic provided in Table 8. Table 9 provides the logic for use with the SKY12208-306LF Evaluation Board.

Power derating data is plotted against temperature in Figures 19 and 20. Equivalent circuit diagrams for transmit and receive are shown in Figure 21.

**Table 2. SKY12208-306LF Absolute Maximum Ratings**

Parameter	Symbol	Minimum	Maximum	Units
RF CW input power, TX and ANT ports ( $T_{\text{SUBSTRATE}} = 25\text{ }^{\circ}\text{C}$ )	$P_{\text{IN}}$		75	W
RF peak input power, TX and ANT ports ( $T_{\text{SUBSTRATE}} = 25\text{ }^{\circ}\text{C}$ , RF burst width = 10 $\mu\text{s}$ , RF burst repetition rate = 25 kHz)	$P_{\text{IN}}$		300	W
RF CW input power, RX port ( $T_{\text{SUBSTRATE}} = 25\text{ }^{\circ}\text{C}$ )	$P_{\text{IN}}$		60	W
RF peak input power, RX port ( $T_{\text{SUBSTRATE}} = 25\text{ }^{\circ}\text{C}$ , RF burst width = 10 $\mu\text{s}$ , RF burst repetition rate = 25 kHz)	$P_{\text{IN}}$		240	W
Control port reverse voltage	$V_{\text{CTL}}$		200	V
Control port forward current	$I_{\text{CTL}}$		200	mA
Operating temperature	$T_{\text{OP}}$	-55	+175	$^{\circ}\text{C}$
Storage temperature	$T_{\text{STG}}$	-55	+200	$^{\circ}\text{C}$
Electrostatic discharge:	ESD			
Charged Device Model (CDM), Class 4			1000	V
Human Body Model (HBM), Class 1A			250	V
Machine Model (MM), Class B			150	V

**Note:** Exposure to maximum rating conditions for extended periods may reduce device reliability. There is no damage to device with only one parameter set at the limit and all other parameters set at or below their nominal value. Exceeding any of the limits listed here may result in permanent damage to the device.

**CAUTION:** Although this device is designed to be as robust as possible, Electrostatic Discharge (ESD) can damage this device. This device must be protected at all times from ESD. Static charges may easily produce potentials of several kilovolts on the human body or equipment, which can discharge without detection. Industry-standard ESD precautions should be used at all times.

**Table 3. Recommended Operating Conditions (Per ANT, TX, RX, and RX\_BIAS Inputs)**

Parameter	Symbol	Min	Typical	Max	Units
Control port reverse voltage	$V_{\text{CTL}}$	5	28	100	V
Control port forward current	$I_{\text{CTL}}$	20	50	100	mA

**Table 4. SKY12208-306LF Electrical Specifications, Bias Voltage = 28 V (1 of 2) (Note 1)**  
**(T<sub>OP</sub> = +25 °C, Characteristic Impedance [Z<sub>0</sub>] = 50 Ω, EVB Optimized for 0.02 to 0.70 GHz Operation, Unless Otherwise Noted)**

Parameter	Symbol	Test Condition	Min	Typical	Max	Units	
Insertion loss, TX to ANT ports	IL <sub>TX-ANT</sub>	V <sub>PIN_2</sub> = 1 V, I <sub>PIN_14</sub> = -50 mA, I <sub>PIN_9</sub> = -50 mA, V <sub>PIN_7</sub> = 28 V, TX port P <sub>IN</sub> @ pin 14 = 0 dBm:					
			0.02 GHz		0.39	0.50	dB
			0.05 GHz		0.16	0.30	dB
			0.25 GHz		0.10	0.25	dB
			0.50 GHz		0.18	0.40	dB
0.70 GHz		0.40	0.90	dB			
Insertion loss, ANT to RX ports	IL <sub>ANT-RX</sub>	V <sub>PIN_2</sub> = 1 V, V <sub>PIN_14</sub> = 28 V, I <sub>PIN_7</sub> = -50 mA, V <sub>PIN_9</sub> = 28 V, ANT port P <sub>IN</sub> @ pin 2 = 0 dBm:					
			0.02 GHz		0.29	0.50	dB
			0.05 GHz		0.16	0.30	dB
			0.25 GHz		0.10	0.25	dB
			0.50 GHz		0.17	0.40	dB
0.70 GHz		0.40	0.90	dB			
Isolation, TX to RX ports	ISO <sub>TX-RX</sub>	V <sub>PIN_2</sub> = 1 V, I <sub>PIN_14</sub> = -50 mA, I <sub>PIN_9</sub> = -50 mA, V <sub>PIN_7</sub> = 28 V, TX port P <sub>IN</sub> @ pin 14 = 0 dBm:					
			0.02 GHz	45	49		dB
			0.05 GHz	45	50		dB
			0.25 GHz	38	42		dB
			0.50 GHz	35	39		dB
0.70 GHz	34	39		dB			
Isolation, ANT to TX ports	ISO <sub>ANT-TX</sub>	V <sub>PIN_2</sub> = 1 V, V <sub>PIN_14</sub> = 28 V, I <sub>PIN_7</sub> = -50 mA, V <sub>PIN_9</sub> = 28 V, ANT port P <sub>IN</sub> @ pin 2 = 0 dBm:					
			0.02 GHz	45	58		dB
			0.05 GHz	45	49		dB
			0.25 GHz	33	36		dB
			0.50 GHz	27	31		dB
0.70 GHz	25	29		dB			
Isolation, ANT to RX ports	ISO <sub>ANT-RX</sub>	V <sub>PIN_2</sub> = 1 V, I <sub>PIN_14</sub> = -50 mA, I <sub>PIN_9</sub> = -50 mA, V <sub>PIN_7</sub> = 28 V, ANT port P <sub>IN</sub> @ pin 2 = 0 dBm:					
			0.02 GHz	45	49		dB
			0.05 GHz	45	49		dB
			0.25 GHz	38	41		dB
			0.50 GHz	35	39		dB
0.70 GHz	34	39		dB			

**Table 4. SKY12208-306LF Electrical Specifications, Bias Voltage = 28 V (2 of 2) (Note 1)**  
**(T<sub>OP</sub> = +25 °C, Characteristic Impedance [Z<sub>0</sub>] = 50 Ω, EVB Optimized for 0.02 to 0.70 GHz Operation, Unless Otherwise Noted)**

Parameter	Symbol	Test Condition	Min	Typical	Max	Units		
Input return loss		0.02 to 0.70 GHz: RX insertion loss state, ANT port (@ pin 2)		22		dB		
		TX insertion loss state, TX port (@ pin 14)		23		dB		
Transmit 2 <sup>nd</sup> harmonic	2fo	TX insertion loss state, TX port P <sub>IN</sub> @ pin 14 = +30 dBm:						
		0.05 GHz		-78		dBc		
		0.25 GHz		-82		dBc		
		0.50 GHz		-95		dBc		
Transmit 3 <sup>rd</sup> harmonic	3fo	TX insertion loss state, TX port P <sub>IN</sub> @ pin 14 = +30 dBm:						
		0.05 GHz		-92		dBc		
		0.25 GHz		-85		dBc		
		0.50 GHz		-81		dBc		
Transmit 3 <sup>rd</sup> Order Input Intercept Point	IIP3	0.70 GHz		-78		dBc		
		V <sub>PIN_2</sub> = 1 V, I <sub>PIN_14</sub> = -50 mA, I <sub>PIN_9</sub> = -50 mA, V <sub>PIN_7</sub> = 28 V, TX port P <sub>IN</sub> @ pin 14 = 0 dBm/tone, tone spacing = 1 MHz, @ 0.25 GHz		+45		dBm		
		Maximum transmit CW input power	P <sub>IN_CW</sub>	V <sub>PIN_2</sub> = 1 V, I <sub>PIN_14</sub> = -50 mA, I <sub>PIN_9</sub> = -50 mA, V <sub>PIN_7</sub> = 28 V, 0.02 to 0.70 GHz		50		W
		Maximum receive CW input power	P <sub>IN_CW</sub>	V <sub>PIN_2</sub> = 1 V, V <sub>PIN_14</sub> = 28 V, I <sub>PIN_7</sub> = -50 mA, V <sub>PIN_9</sub> = 28 V, 0.02 to 0.70 GHz		40		W
Transmit RF switching time	tsw	10% to 90% RF on, repetition rate = 0.5 MHz, @ 0.25 GHz		85		ns		

**Note 1:** Performance is guaranteed only under the conditions listed in this Table.

**Table 5. SKY12208-306LF Electrical Specifications, Bias Voltage = 5 V (1 of 2) (Note 1)**  
**(T<sub>OP</sub> = +25 °C, Characteristic Impedance [Z<sub>0</sub>] = 50 Ω, EVB Optimized for 0.02 to 0.70 GHz Operation, Unless Otherwise Noted)**

Parameter	Symbol	Test Condition	Min	Typical	Max	Units				
Insertion loss, TX to ANT ports	IL <sub>TX-ANT</sub>	V <sub>PIN_2</sub> = 1 V, I <sub>PIN_14</sub> = -50 mA, I <sub>PIN_9</sub> = -50 mA, V <sub>PIN_7</sub> = 5 V, TX port P <sub>IN</sub> @ pin 14 = 0 dBm:								
							0.02 GHz	0.37	0.50	dB
							0.05 GHz	0.13	0.30	dB
							0.25 GHz	0.10	0.25	dB
							0.50 GHz	0.17	0.40	dB
0.70 GHz	0.41	0.90	dB							
Insertion loss, ANT to RX ports	IL <sub>ANT-RX</sub>	V <sub>PIN_2</sub> = 1 V, V <sub>PIN_14</sub> = 5 V, I <sub>PIN_7</sub> = -50 mA, V <sub>PIN_9</sub> = 5 V, ANT port P <sub>IN</sub> @ pin 2 = 0 dBm:								
							0.02 GHz	0.26	0.50	dB
							0.05 GHz	0.13	0.30	dB
							0.25 GHz	0.10	0.25	dB
							0.50 GHz	0.17	0.40	dB
0.70 GHz	0.41	0.90	dB							
Isolation, TX to RX ports	ISO <sub>TX-RX</sub>	V <sub>PIN_2</sub> = 1 V, I <sub>PIN_14</sub> = -50 mA, I <sub>PIN_9</sub> = -50 mA, V <sub>PIN_7</sub> = 5 V, TX port P <sub>IN</sub> @ pin 14 = 0 dBm:								
							0.02 GHz	45	49	dB
							0.05 GHz	45	49	dB
							0.25 GHz	38	41	dB
							0.50 GHz	35	39	dB
0.70 GHz	34	39	dB							
Isolation, ANT to TX ports	ISO <sub>ANT-TX</sub>	V <sub>PIN_2</sub> = 1 V, V <sub>PIN_14</sub> = 5 V, I <sub>PIN_7</sub> = -50 mA, V <sub>PIN_9</sub> = 5 V, ANT port P <sub>IN</sub> @ pin 2 = 0 dBm:								
							0.02 GHz	45	61	dB
							0.05 GHz	45	50	dB
							0.25 GHz	33	37	dB
							0.50 GHz	27	31	dB
0.70 GHz	25	29	dB							
Isolation, ANT to RX ports	ISO <sub>ANT-RX</sub>	V <sub>PIN_2</sub> = 1 V, I <sub>PIN_14</sub> = -50 mA, I <sub>PIN_9</sub> = -50 mA, V <sub>PIN_7</sub> = 5 V, ANT port P <sub>IN</sub> @ pin 2 = 0 dBm:								
							0.02 GHz	45	49	dB
							0.05 GHz	45	49	dB
							0.25 GHz	38	41	dB
							0.50 GHz	35	39	dB
0.70 GHz	34	39	dB							

**Table 5. SKY12208-306LF Electrical Specifications, Bias Voltage = 5 V (2 of 2) (Note 1)**  
**(T<sub>OP</sub> = +25 °C, Characteristic Impedance [Z<sub>0</sub>] = 50 Ω, EVB Optimized for 0.02 to 0.70 GHz Operation, Unless Otherwise Noted)**

Parameter	Symbol	Test Condition	Min	Typical	Max	Units		
Input return loss		0.02 to 0.70 GHz: RX insertion loss state, ANT port (@ pin 2)		22		dB		
		TX insertion loss state, TX port (@ pin 14)		24		dB		
Transmit 2 <sup>nd</sup> harmonic	2fo	TX insertion loss state, TX port P <sub>IN</sub> @ pin 14 = +30 dBm:						
		0.05 GHz		-31		dBc		
		0.25 GHz		-40		dBc		
		0.50 GHz		-50		dBc		
Transmit 3 <sup>rd</sup> harmonic	3fo	TX insertion loss state, TX port P <sub>IN</sub> @ pin 14 = +30 dBm:						
		0.05 GHz		-36		dBc		
		0.25 GHz		-43		dBc		
		0.50 GHz		-52		dBc		
Transmit 3 <sup>rd</sup> Order Input Intercept Point	IIP3	0.70 GHz		-67		dBc		
		V <sub>PIN_2</sub> = 1 V, I <sub>PIN_14</sub> = -50 mA, I <sub>PIN_9</sub> = -50 mA, V <sub>PIN_7</sub> = 5 V, TX port P <sub>IN</sub> @ pin 14 = 0 dBm/tone, tone spacing = 1 MHz, @ 0.25 GHz		+45		dBm		
		Maximum transmit CW input power	P <sub>IN_CW</sub>	V <sub>PIN_2</sub> = 1 V, I <sub>PIN_14</sub> = -50 mA, I <sub>PIN_9</sub> = -50 mA, V <sub>PIN_7</sub> = 5 V, 0.02 to 0.70 GHz		15		W
		Maximum receive CW input power	P <sub>IN_CW</sub>	V <sub>PIN_2</sub> = 1 V, V <sub>PIN_14</sub> = 5 V, I <sub>PIN_7</sub> = 50 mA, V <sub>PIN_9</sub> = 5 V, 0.02 to 0.70 GHz		10		W
Transmit RF switching time	tsw	10% to 90% RF on, repetition rate = 0.5 MHz, @ 0.25 GHz		85		ns		

**Note 1:** Performance is guaranteed only under the conditions listed in this Table.

**Table 6. SKY12208-306LF Electrical Specifications, Bias Voltage = 28 V (1 of 2) (Note 1)**  
**(T<sub>OP</sub> = +25 °C, Characteristic Impedance [Z<sub>0</sub>] = 50 Ω, EVB Optimized for 0.05 to 2.70 GHz Operation, Unless Otherwise Noted)**

Parameter	Symbol	Test Condition	Min	Typical	Max	Units			
Insertion loss, TX to ANT ports	IL <sub>TX-ANT</sub>	V <sub>PIN_2</sub> = 1 V, I <sub>PIN_14</sub> = -50 mA, I <sub>PIN_9</sub> = -50 mA, V <sub>PIN_7</sub> = 28 V, TX port P <sub>IN</sub> @ pin 14 = 0 dBm:							
							0.05 GHz	0.36	dB
							0.50 GHz	0.25	dB
							1.00 GHz	0.29	dB
							1.50 GHz	0.35	dB
							2.00 GHz	0.42	dB
							2.50 GHz	0.46	dB
Insertion loss, ANT to RX ports	IL <sub>ANT-RX</sub>	V <sub>PIN_2</sub> = 1 V, V <sub>PIN_14</sub> = 28 V, I <sub>PIN_7</sub> = -50 mA, V <sub>PIN_9</sub> = 28 V, ANT port P <sub>IN</sub> @ pin 2 = 0 dBm:							
							0.05 GHz	0.43	dB
							0.50 GHz	0.24	dB
							1.00 GHz	0.30	dB
							1.50 GHz	0.40	dB
							2.00 GHz	0.49	dB
							2.50 GHz	0.53	dB
Isolation, TX to RX ports	ISO <sub>TX-RX</sub>	V <sub>PIN_2</sub> = 1 V, I <sub>PIN_14</sub> = -50 mA, I <sub>PIN_9</sub> = -50 mA, V <sub>PIN_7</sub> = 28 V, TX port P <sub>IN</sub> @ pin 14 = 0 dBm:							
							0.05 GHz	48	dB
							0.50 GHz	42	dB
							1.00 GHz	46	dB
							1.50 GHz	49	dB
							2.00 GHz	41	dB
							2.50 GHz	34	dB
Isolation, ANT to TX ports	ISO <sub>ANT-TX</sub>	V <sub>PIN_2</sub> = 1 V, V <sub>PIN_14</sub> = 28 V, I <sub>PIN_7</sub> = -50 mA, V <sub>PIN_9</sub> = 28 V, ANT port P <sub>IN</sub> @ pin 2 = 0 dBm:							
							0.05 GHz	51	dB
							0.50 GHz	31	dB
							1.00 GHz	25	dB
							1.50 GHz	23	dB
							2.00 GHz	21	dB
							2.50 GHz	20	dB
Isolation, ANT to RX ports	ISO <sub>ANT-RX</sub>	V <sub>PIN_2</sub> = 1 V, I <sub>PIN_14</sub> = -50 mA, I <sub>PIN_9</sub> = -50 mA, V <sub>PIN_7</sub> = 28 V, ANT port P <sub>IN</sub> @ pin 2 = 0 dBm:							
							0.05 GHz	49	dB
							0.50 GHz	42	dB
							1.00 GHz	44	dB
							1.50 GHz	45	dB
							2.00 GHz	38	dB
							2.50 GHz	33	dB



**Table 6. SKY12208-306LF Electrical Specifications, Bias Voltage = 28 V (2 of 2) (Note 1)**  
**(T<sub>OP</sub> = +25 °C, Characteristic Impedance [Z<sub>0</sub>] = 50 Ω, EVB Optimized for 0.05 to 2.70 GHz Operation, Unless Otherwise Noted)**

Parameter	Symbol	Test Condition	Min	Typical	Max	Units
Input return loss		0.05 to 2.70 GHz: RX insertion loss state, ANT port (@ pin 2)		21		dB
		TX insertion loss state, TX port (@ pin 14)		20		dB
Transmit 2 <sup>nd</sup> harmonic	2fo	TX insertion loss state, TX port P <sub>IN</sub> @ pin 14 = +30 dBm:				
		0.05 GHz		-78		dBc
		0.50 GHz		-82		dBc
		1.00 GHz		-95		dBc
		1.50 GHz		-88		dBc
		2.00 GHz		-85		dBc
2.50 GHz		-80		dBc		
Transmit 3 <sup>rd</sup> harmonic	3fo	TX insertion loss state, TX port P <sub>IN</sub> @ pin 14 = +30 dBm:				
		0.05 GHz		-92		dBc
		0.50 GHz		-85		dBc
		1.00 GHz		-81		dBc
		1.50 GHz		-78		dBc
		2.00 GHz		-75		dBc
2.50 GHz		-70		dBc		
Transmit 3 <sup>rd</sup> Order Input Intercept Point	IIP3	V <sub>PIN_2</sub> = 1 V, I <sub>PIN_14</sub> = -50 mA, I <sub>PIN_9</sub> = -50 mA, V <sub>PIN_7</sub> = 28 V, TX port P <sub>IN</sub> @ pin 14 = +30 dBm/tone, tone spacing = 1 MHz, @ 2.0 GHz		+77		dBm
Maximum transmit CW input power	P <sub>IN_CW</sub>	V <sub>PIN_2</sub> = 1 V, I <sub>PIN_14</sub> = -50 mA, I <sub>PIN_9</sub> = -50 mA, V <sub>PIN_7</sub> = 28 V, 0.05 to 2.70 GHz		50		W
Maximum receive CW input power	P <sub>IN_CW</sub>	V <sub>PIN_2</sub> = 1 V, V <sub>PIN_14</sub> = 28 V, I <sub>PIN_7</sub> = 50 mA, V <sub>PIN_9</sub> = 28 V, 0.05 to 2.70 GHz		40		W
Transmit RF switching time	t <sub>sw</sub>	10% to 90% RF on, repetition rate = 0.5 MHz, @ 2.0 GHz		85		ns

**Note 1:** Performance is guaranteed only under the conditions listed in this Table.

**Table 7. SKY12208-306LF Electrical Specifications, Bias Voltage = 5 V (1 of 2) (Note 1)**  
**(T<sub>OP</sub> = +25 °C, Characteristic Impedance [Z<sub>0</sub>] = 50 Ω, EVB Optimized for 0.05 to 2.70 GHz Operation, Unless Otherwise Noted)**

Parameter	Symbol	Test Condition	Min	Typical	Max	Units	
Insertion loss, TX to ANT ports	IL <sub>TX-ANT</sub>	V <sub>PIN_2</sub> = 1 V, I <sub>PIN_14</sub> = -50 mA, I <sub>PIN_9</sub> = -50 mA, V <sub>PIN_7</sub> = 5 V, TX port P <sub>IN</sub> @ pin 14 = 0 dBm:					
				0.05 GHz	0.27		dB
				0.50 GHz	0.25		dB
				1.00 GHz	0.31		dB
				1.50 GHz	0.37		dB
				2.00 GHz	0.44		dB
				2.50 GHz	0.50		dB
Insertion loss, ANT to RX ports	IL <sub>ANT-RX</sub>	V <sub>PIN_2</sub> = 1 V, V <sub>PIN_14</sub> = 5 V, I <sub>PIN_7</sub> = -50 mA, V <sub>PIN_9</sub> = 5 V, ANT port P <sub>IN</sub> @ pin 2 = 0 dBm:					
				0.05 GHz	0.40		dB
				0.50 GHz	0.25		dB
				1.00 GHz	0.33		dB
				1.50 GHz	0.42		dB
				2.00 GHz	0.50		dB
				2.50 GHz	0.58		dB
Isolation, TX to RX ports	ISO <sub>TX-RX</sub>	V <sub>PIN_2</sub> = 1 V, I <sub>PIN_14</sub> = -50 mA, I <sub>PIN_9</sub> = -50 mA, V <sub>PIN_7</sub> = 5 V, TX port P <sub>IN</sub> @ pin 14 = 0 dBm:					
				0.05 GHz	49		dB
				0.50 GHz	41		dB
				1.00 GHz	45		dB
				1.50 GHz	49		dB
				2.00 GHz	40		dB
				2.50 GHz	34		dB
Isolation, ANT to TX ports	ISO <sub>ANT-TX</sub>	V <sub>PIN_2</sub> = 1 V, V <sub>PIN_14</sub> = 5 V, I <sub>PIN_7</sub> = -50 mA, V <sub>PIN_9</sub> = 5 V, ANT port P <sub>IN</sub> @ pin 2 = 0 dBm:					
				0.05 GHz	51		dB
				0.50 GHz	31		dB
				1.00 GHz	25		dB
				1.50 GHz	22		dB
				2.00 GHz	21		dB
				2.50 GHz	19		dB
Isolation, ANT to RX ports	ISO <sub>ANT-RX</sub>	V <sub>PIN_2</sub> = 1 V, I <sub>PIN_14</sub> = -50 mA, I <sub>PIN_9</sub> = -50 mA, V <sub>PIN_7</sub> = 5 V, ANT port P <sub>IN</sub> @ pin 2 = 0 dBm:					
				0.05 GHz	48		dB
				0.50 GHz	41		dB
				1.00 GHz	44		dB
				1.50 GHz	44		dB
				2.00 GHz	38		dB
				2.50 GHz	32		dB

**Table 7. SKY12208-306LF Electrical Specifications, Bias Voltage = 5 V (2 of 2) (Note 1)**  
**(T<sub>OP</sub> = +25 °C, Characteristic Impedance [Z<sub>0</sub>] = 50 Ω, EVB Optimized for 0.05 to 2.70 GHz Operation, Unless Otherwise Noted)**

Parameter	Symbol	Test Condition	Min	Typical	Max	Units
Input return loss		0.05 to 2.70 GHz: RX insertion loss state, ANT port (@ pin 2)		21		dB
		TX insertion loss state, TX port (@ pin 14)		20		dB
Transmit 2 <sup>nd</sup> harmonic	2fo	TX insertion loss state, TX port P <sub>IN</sub> @ pin 14 = +30 dBm:				
		0.05 GHz		-31		dBc
		0.50 GHz		-40		dBc
		1.00 GHz		-50		dBc
		1.50 GHz		-55		dBc
		2.00 GHz		-50		dBc
2.50 GHz		-45		dBc		
Transmit 3 <sup>rd</sup> harmonic	3fo	TX insertion loss state, TX port P <sub>IN</sub> @ pin 14 = +30 dBm:				
		0.05 GHz		-36		dBc
		0.50 GHz		-43		dBc
		1.00 GHz		-52		dBc
		1.50 GHz		-67		dBc
		2.00 GHz		-55		dBc
2.50 GHz		-45		dBc		
Transmit 3 <sup>rd</sup> Order Input Intercept Point	IIP3	V <sub>PIN_2</sub> = 1 V, I <sub>PIN_14</sub> = -50 mA, I <sub>PIN_9</sub> = -50 mA, V <sub>PIN_7</sub> = 5 V, TX port P <sub>IN</sub> @ pin 14 = +30 dBm/tone, tone spacing = 1 MHz, @ 2.0 GHz		+56		dBm
Maximum transmit CW input power	P <sub>IN_CW</sub>	V <sub>PIN_2</sub> = 1 V, I <sub>PIN_14</sub> = -50 mA, I <sub>PIN_9</sub> = -50 mA, V <sub>PIN_7</sub> = 5 V, 0.05 to 2.70 GHz		15		W
Maximum receive CW input power	P <sub>IN_CW</sub>	V <sub>PIN_2</sub> = 1 V, V <sub>PIN_14</sub> = 5 V, I <sub>PIN_7</sub> = 50 mA, V <sub>PIN_9</sub> = 5 V, 0.05 to 2.70 GHz		10		W
Transmit RF switching time	t <sub>sw</sub>	10% to 90% RF on, repetition rate = 0.5 MHz, @ 2.0 GHz		85		ns

**Note 1:** Performance is guaranteed only under the conditions listed in this Table.

### Typical Performance Characteristics

( $T_{OP} = +25\text{ }^{\circ}\text{C}$ , Characteristic Impedance [ $Z_0$ ] = 50  $\Omega$ , EVB Optimized for 0.02 to 0.70 GHz Operation, Unless Otherwise Noted)

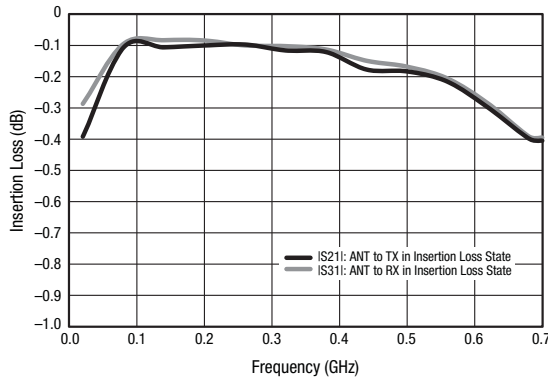

**Figure 3. Insertion Loss vs Frequency**  
(ANT to RX and ANT to TX Ports;  $V_{CTL} = 28\text{ V}$ ,  $I_{CTL} = -50\text{ mA}$ )

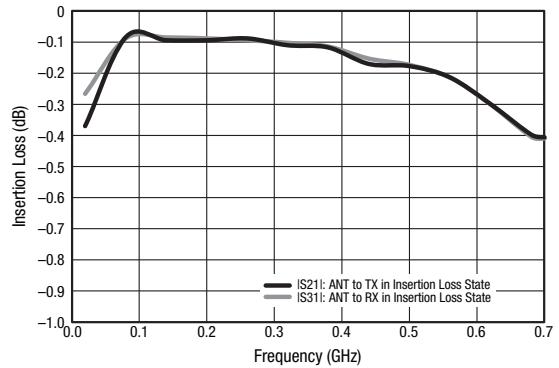

**Figure 4. Insertion Loss vs Frequency**  
(ANT to RX and ANT to TX Ports;  $V_{CTL} = 5\text{ V}$ ,  $I_{CTL} = -50\text{ mA}$ )

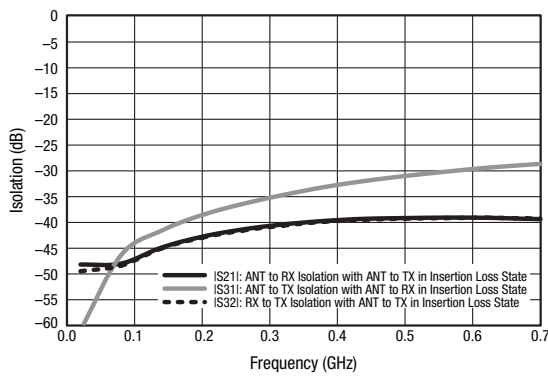

**Figure 5. Isolation vs Frequency**  
(ANT to RX, TX to RX, and ANT to TX Ports;  
 $V_{CTL} = 28\text{ V}$ ,  $I_{CTL} = -50\text{ mA}$ )

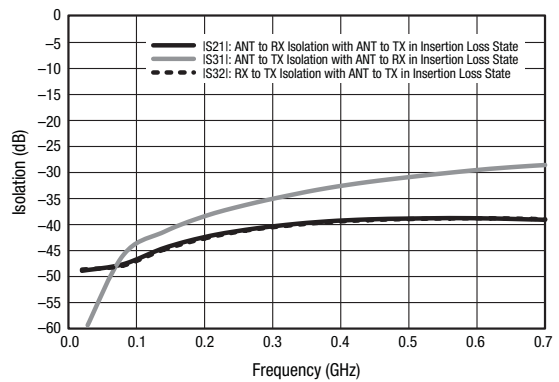

**Figure 6. Isolation vs Frequency**  
(ANT to RX, TX to RX, and ANT to TX Ports;  
 $V_{CTL} = 5\text{ V}$ ,  $I_{CTL} = -50\text{ mA}$ )

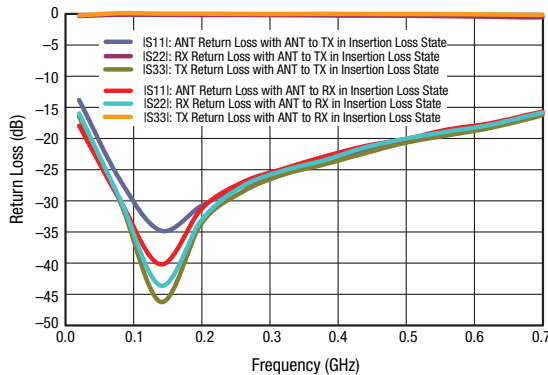

**Figure 7. Return Loss vs Frequency**  
(ANT, TX, and RX Ports;  $V_{CTL} = 28\text{ V}$ ,  $I_{CTL} = -50\text{ mA}$ )

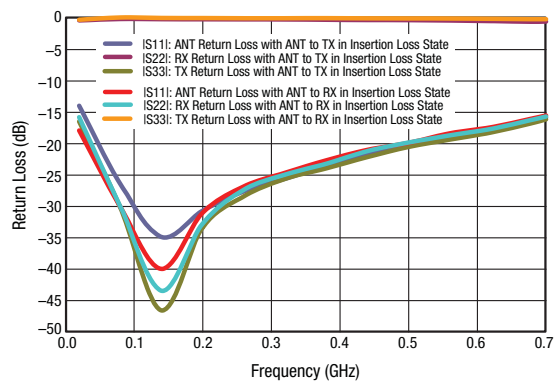

**Figure 8. Return Loss vs Frequency**  
(ANT, TX, and RX Ports;  $V_{CTL} = 5\text{ V}$ ,  $I_{CTL} = -50\text{ mA}$ )

### Typical Performance Characteristics

( $T_{OP} = +25\text{ }^{\circ}\text{C}$ , Characteristic Impedance [ $Z_0$ ] = 50  $\Omega$ , EVB Optimized for 0.05 to 2.70 GHz Operation, Unless Otherwise Noted)

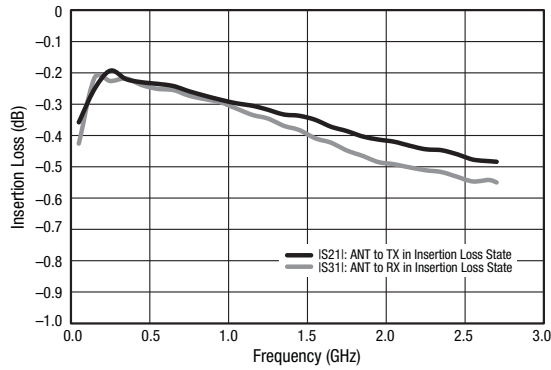

**Figure 9. Insertion Loss vs Frequency**  
(ANT to RX and ANT to TX Ports;  $V_{CTL} = 28\text{ V}$ ,  $I_{CTL} = -50\text{ mA}$ )

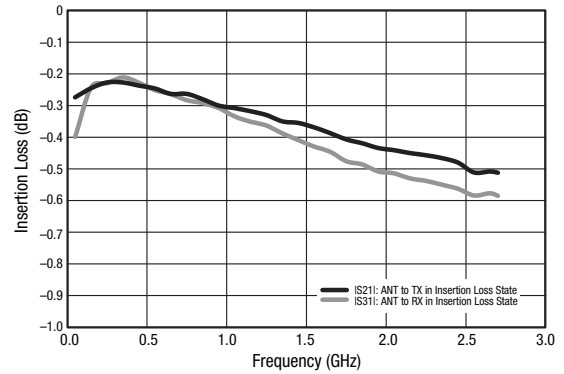

**Figure 10. Insertion Loss vs Frequency**  
(ANT to RX and ANT to TX Ports;  $V_{CTL} = 5\text{ V}$ ,  $I_{CTL} = -50\text{ mA}$ )

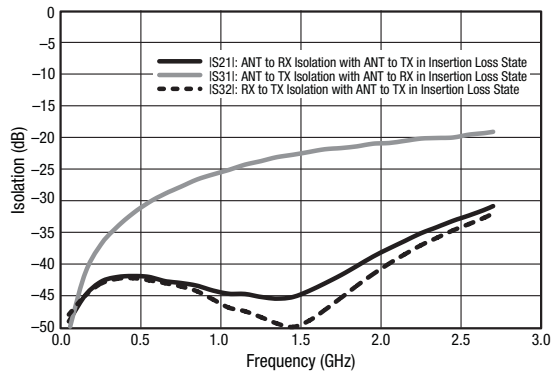

**Figure 11. Isolation vs Frequency**  
(ANT to RX, TX to RX, and ANT to TX Ports;  
 $V_{CTL} = 28\text{ V}$ ,  $I_{CTL} = -50\text{ mA}$ )

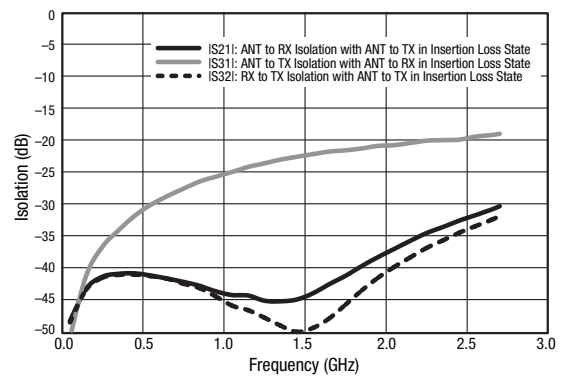

**Figure 12. Isolation vs Frequency**  
(ANT to RX, TX to RX, and ANT to TX Ports;  
 $V_{CTL} = 5\text{ V}$ ,  $I_{CTL} = -50\text{ mA}$ )

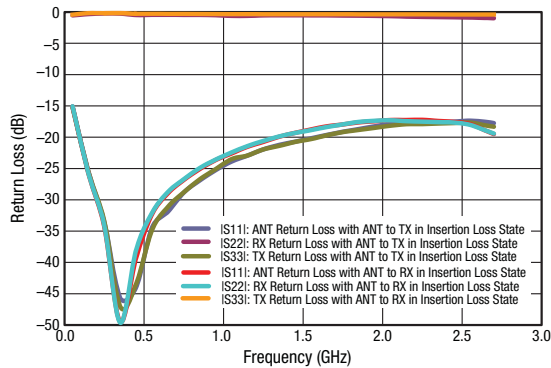

**Figure 13. Return Loss vs Frequency**  
(ANT, TX, and RX Ports;  $V_{CTL} = 28\text{ V}$ ,  $I_{CTL} = -50\text{ mA}$ )

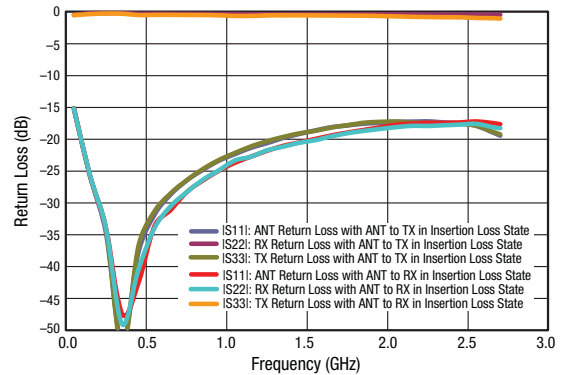

**Figure 14. Return Loss vs Frequency**  
(ANT, TX, and RX Ports;  $V_{CTL} = 5\text{ V}$ ,  $I_{CTL} = -50\text{ mA}$ )

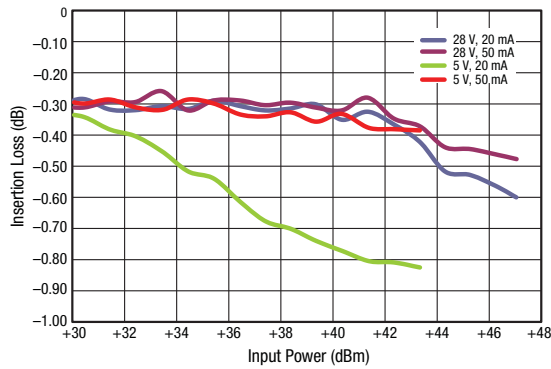

Figure 15. Insertion Loss vs CW Input Power (ANT to RX Port, f = 0.25 GHz)

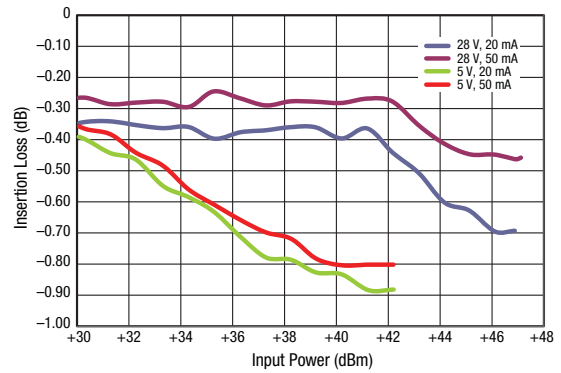

Figure 16. Insertion Loss vs CW Input Power (TX to ANT Port, f = 0.25 GHz)

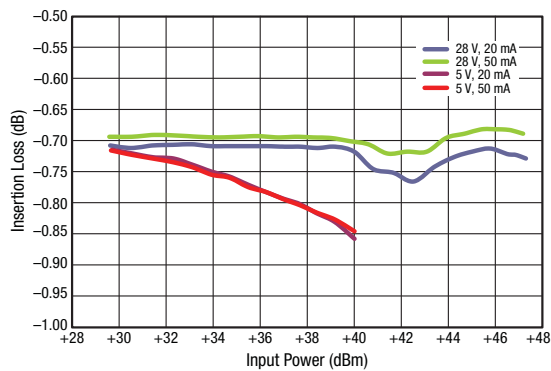

Figure 17. Insertion Loss vs CW Input Power (ANT to RX Port, f = 2.0 GHz)

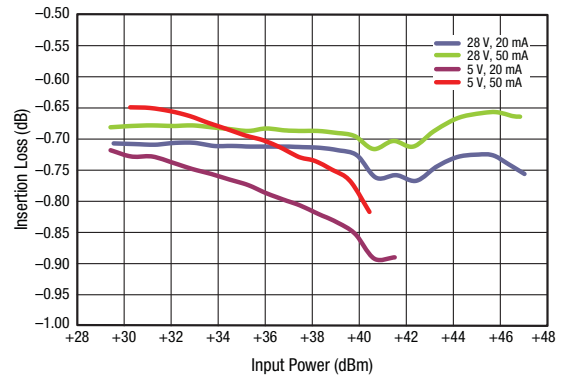

Figure 18. Insertion Loss vs CW Input Power (TX to ANT Port, f = 2.0 GHz)

Table 8. SKY12208-306LF Truth Table

Switch State	Path		Control Conditions			
	Antenna-to-Receiver Port (Pin 2 to Pin 7)	Transmitter-to-Antenna Port (Pin 14 to Pin 2)	Antenna Port Bias Input (Pin 2)	Nominal Receiver Output Port (Pin 7)	Nominal Transmitter Port Bias Input (Pin 14)	RX_BIAS Input (Pin 9)
Receive (see Figure 21)	Low insertion loss	High isolation	1 V	-50 mA	28 V	28 V
Transmit (see Figure 21)	High isolation	Low insertion loss	1 V	28 V	-50 mA	-50 mA

Table 9. SKY12208-306LF Evaluation Board Truth Table

Switch State	Path		Control Conditions			
	Antenna-to-Receiver Port	Transmitter-to-Antenna Port	Antenna Port Bias Input	Receiver Output Port	Transmitter Port Bias Input	RX_BIAS Input
Receive (see Figure 21)	Low insertion loss	High isolation	5 V	0 V (ground)	28 V	28 V
Transmit (see Figure 21)	High isolation	Low insertion loss	5 V	28 V	0 V (ground)	0 V (ground)

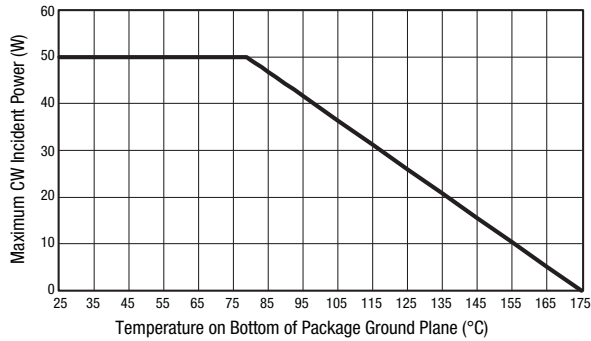

**Figure 19. Transmit Power Derating, Maximum CW Incident Power (Insertion Loss = 0.3 dB) vs Temperature on Bottom of Package Ground Plane**

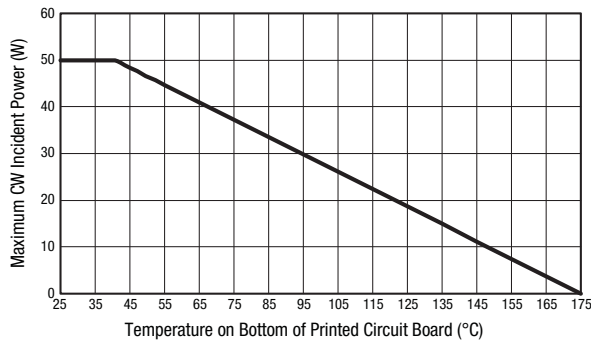

**Figure 20. Transmit Power Derating, Maximum CW Incident Power (Insertion Loss = 0.3 dB) vs Temperature on Bottom of Printed Circuit Board**

### Evaluation Board Description

The SKY12208-306LF Evaluation Board is used to test the performance of the SKY12208-306LF PIN Diode SPDT switch. An assembly drawing for the Evaluation Board is shown in Figure 22. The layer detail is provided in Figure 23.

The SKY12208-306LF is designed to handle very large signals. Sufficient power may be dissipated by this switch to cause heating of the PIN diodes contained in the switch. It is very important to use a printed circuit board design that provides adequate cooling capability to keep the junction temperature of the PIN diodes below their maximum rated operating temperature.

As indicated in Figure 19, the x-axis temperature is referenced to the bottom of the QFN package. A printed circuit board with a very low thermal resistance and external heat sink design must be used to achieve the results shown in this Figure. The power derating curve with the x-axis temperature referenced to the bottom of the printed circuit board is provided in Figure 20.

The evaluation circuit is designed to facilitate control of the SKY12208-306LF transmit/receive switch with bias signals

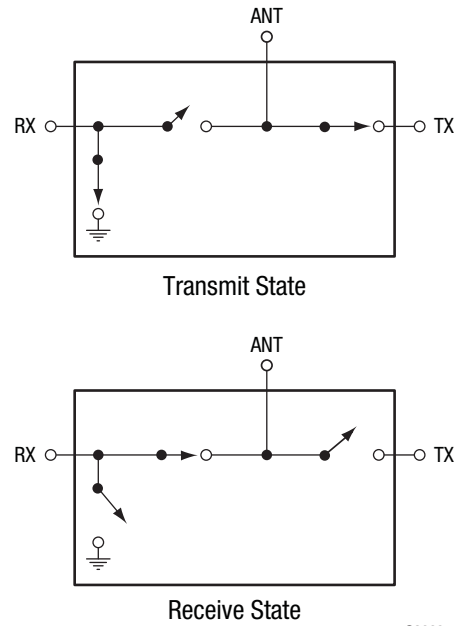

S2398

**Figure 21. SKY12208-306LF Equivalent Circuit Diagrams**

derived from positive voltages. The state of the PIN diodes within the SKY12208-306LF is controlled with 5 V applied to the ANT port and bias voltages of either 28 V or 0 V applied to the remaining bias inputs (RX and TX ports). The switch state circuit diagrams are shown in Figure 21.

The value of resistor R1 (80 Ω) is selected to provide 50 mA of forward current through the "on" series diode with 5 V applied to the ANT port bias pin. The R2 resistance value of 540 Ω is selected to produce approximately 50 mA of forward bias current in the RX shunt diode with a source voltage of 28 V.

The magnitudes of the voltages applied to the TX and RX ports determine which of the RX or TX series diodes is biased into forward conduction. For example, to place the SKY12208-478LF into the transmit state, 0 V is applied to the TX port (which forward biases the diode between pins 2 and 14), 28 V is applied to the RX port (which reverse biases the diode between pins 2 and 7), and 0 V is applied to the RX\_BIAS port (which applies a forward bias through R2 to the diode connected between pins 7 and 9).

The component values shown in the Evaluation Board circuit diagram (Figure 24) were selected to optimize performance in the 0.02 to 0.70 GHz and 0.05 to 2.7 GHz bands.

Refer to Table 10 for the Evaluation Board Bill of Materials. Table 11 provides voltage, current, and resistor values for bias adjustments.

**Package Dimensions**

The PCB layout footprint for the SKY12208-306LF is shown in Figure 25. Typical case markings are noted in Figure 26. Package dimensions for the 16-pin QFN are shown in Figure 27, and tape and reel dimensions are provided in Figure 28.

**Package and Handling Information**

Instructions on the shipping container label regarding exposure to moisture after the container seal is broken must be followed. Otherwise, problems related to moisture absorption may occur when the part is subjected to high temperature during solder assembly.

The SKY12208-306LF is rated to Moisture Sensitivity Level 1 (MSL1) at 260 °C. It can be used for lead or lead-free soldering. For additional information, refer to the Skyworks Application Note, *Solder Reflow Information*, document number 200164.



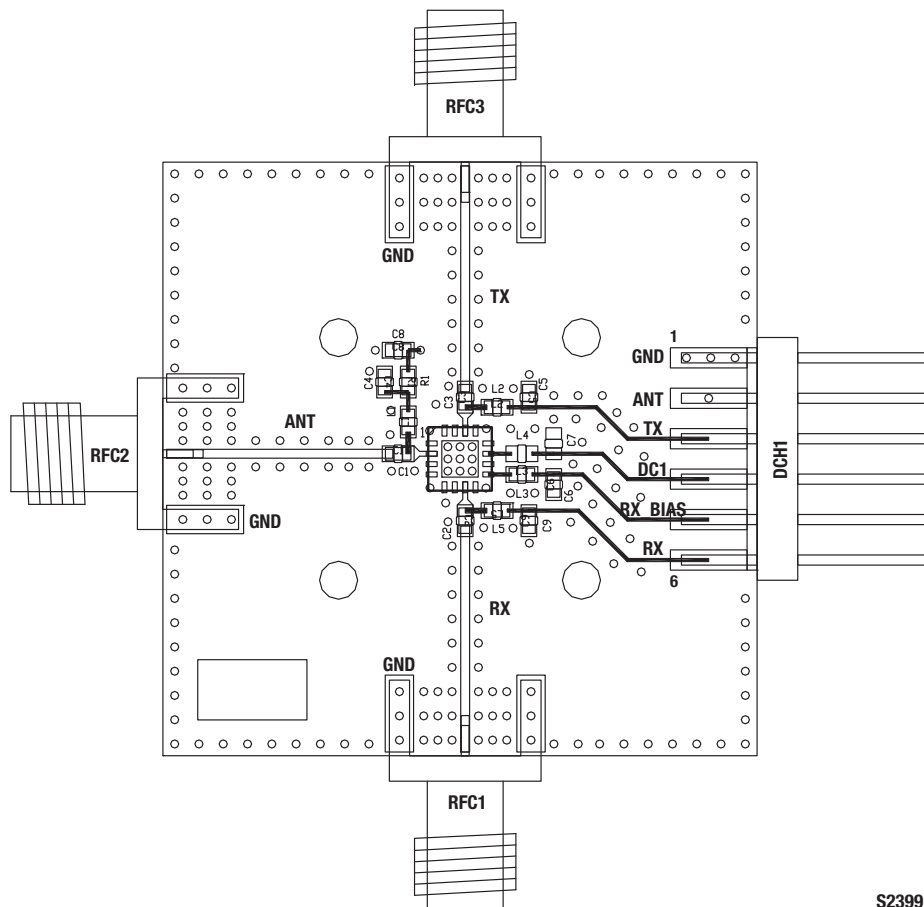





Care must be taken when attaching this product, whether it is done manually or in a production solder reflow environment. Production quantities of this product are shipped in a standard tape and reel format.

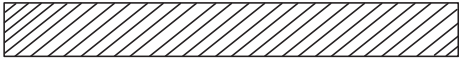

S2399

**Figure 22. SKY12208-306LF Evaluation Board Assembly Diagram**

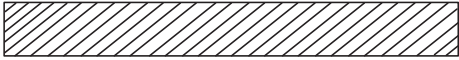

Cross Section	Name	Thickness (in)	Material
	Top Soldermask		
	L1	(0.0028)	Cu foil
	Laminate	0.012 ± 0.0006	Rogers R04003C Core
	L2	(0.0014)	Cu foil
	Laminate	(Note 1)	FR4 Prepreg
	L3	(0.0014)	Cu foil
	Laminate	0.010 ± 0.0006	FR4 Core
	L4	(0.0028)	Cu foil
	Bottom Soldermask		

Note 1: Adjust this thickness to meet total thickness goal of 0.062 ± 0.005 inches.

S2531

**Figure 23. Layer Detail Physical Characteristics**

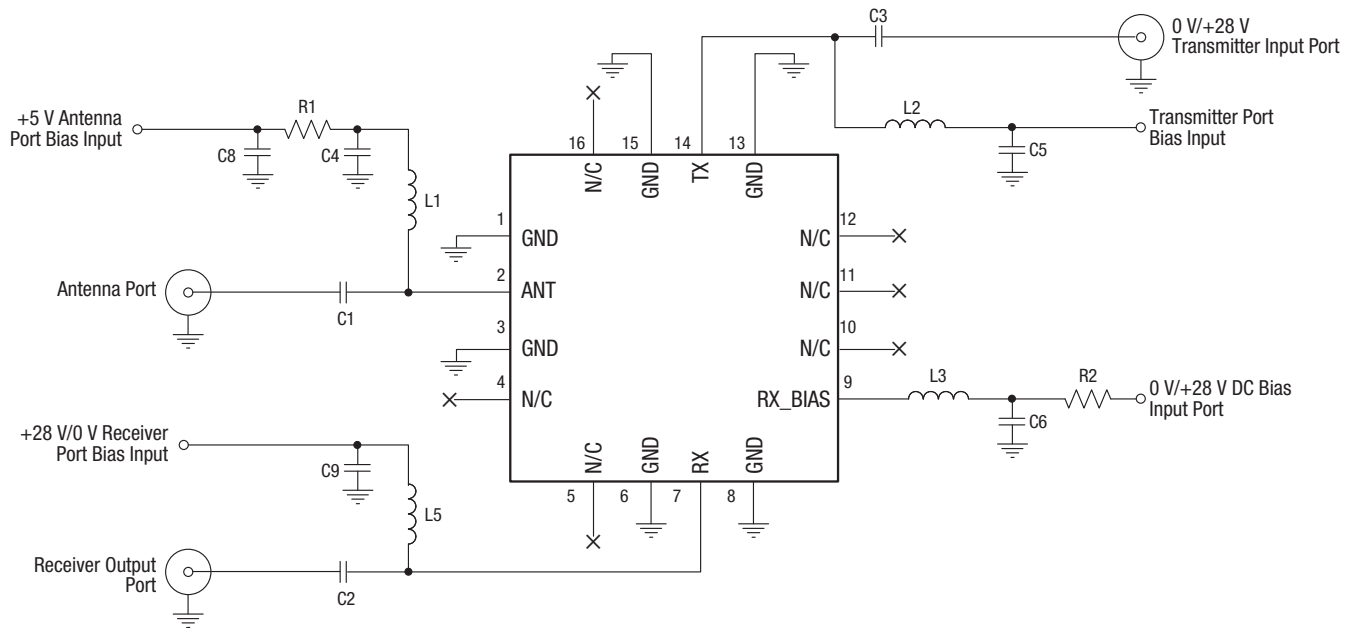

**NOTE:** The N/C pins (4, 5, 10, 11, 12, and 16) are not internally connected, so they can be left open or grounded.

S2402

**Figure 24. Evaluation Board Schematic**

**Table 10. Evaluation Board Bill of Materials (Note 1)**

Component	Value	Size	Product Number	Manufacturer	Mfr Part Number	Characteristics
C1, C2, C3, C4, C5, C6, C9	1000 pF	0603	5404R23-057	TDK	C1608C0G1H102JT	COG, 50 V, ±5%
C8	1 μF	0603	5404R29-070	TDK	C2012X7R1H104K	X7R, 50 V, ±10%
L1, L2, L5 (for 0.02 to 0.7 GHz operation)	1200 nH	0603	–	Coil Craft	0603LS-122XJLB	SRF, 160 MHz, ±5%
L1, L2, L5 (for 0.05 to 2.7 GHz operation)	820 nH	0603	–	Coil Craft	0603LS-821XJLB	SRF, 410 MHz, ±5%
L3	560 nH	0603	–	Coil Craft	0603LS-561XJLB	SRF, 525 MHz, ±5%
R1 (Note 2)	80 Ω	0603	–	Panasonic	ERJ-3GEYJ161V	0.1 W, ±5%
R2 (Note 3)	540 Ω	–	–	–	–	Axial leaded (off board)

**Note 1:** Component values selected are based on the desired frequency and bias level. Values may be adjusted for a specific response.

**Note 2:** Two 160 Ω resistors are combined in parallel to achieve a minimum power handling requirement and 80 Ω resistance.

**Note 3:** Evaluation Board does not include resistor R2. Operating at 28 V and 50 mA requires resistor R2 with a power dissipation greater than 1.35 W.

**Table 11. Component Calculation Values**

Vs (V)	V <sub>DIODE</sub> (V)	V <sub>RES</sub> (V)	Current (A)	Resistance (Ω)	Power Dissipation (W)
28	1	27	0.05	540	1.35
28	1	27	0.02	1350	0.54
5	1	4	0.05	80	0.20
5	1	4	0.02	200	0.08

**Notes:** V<sub>s</sub> = supply voltage; V<sub>DIODE</sub> = voltage drop across the diode; V<sub>RES</sub> = voltage drop across the resistor.

R1 and R2 values are calculated by (V<sub>s</sub> - V<sub>DIODE</sub>)/I, where I is the desired bias current. The power dissipation in R1 or R2 is calculated by I x (V<sub>s</sub> - V<sub>DIODE</sub>). The resistor selected must be safely rated with a power greater than the dissipated power.

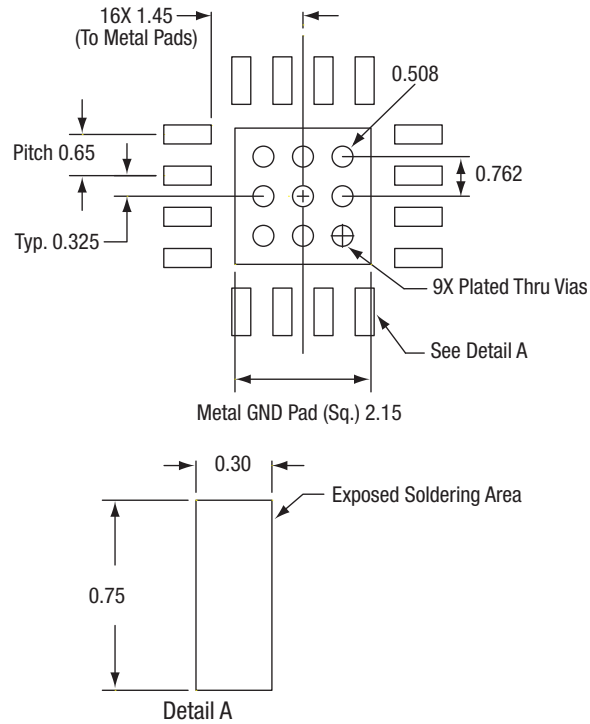

All measurements in millimeters

S2274

Figure 25. SKY12208-306LF PCB Layout Footprint

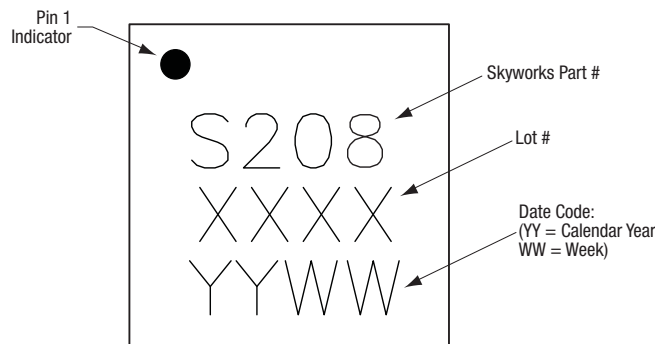
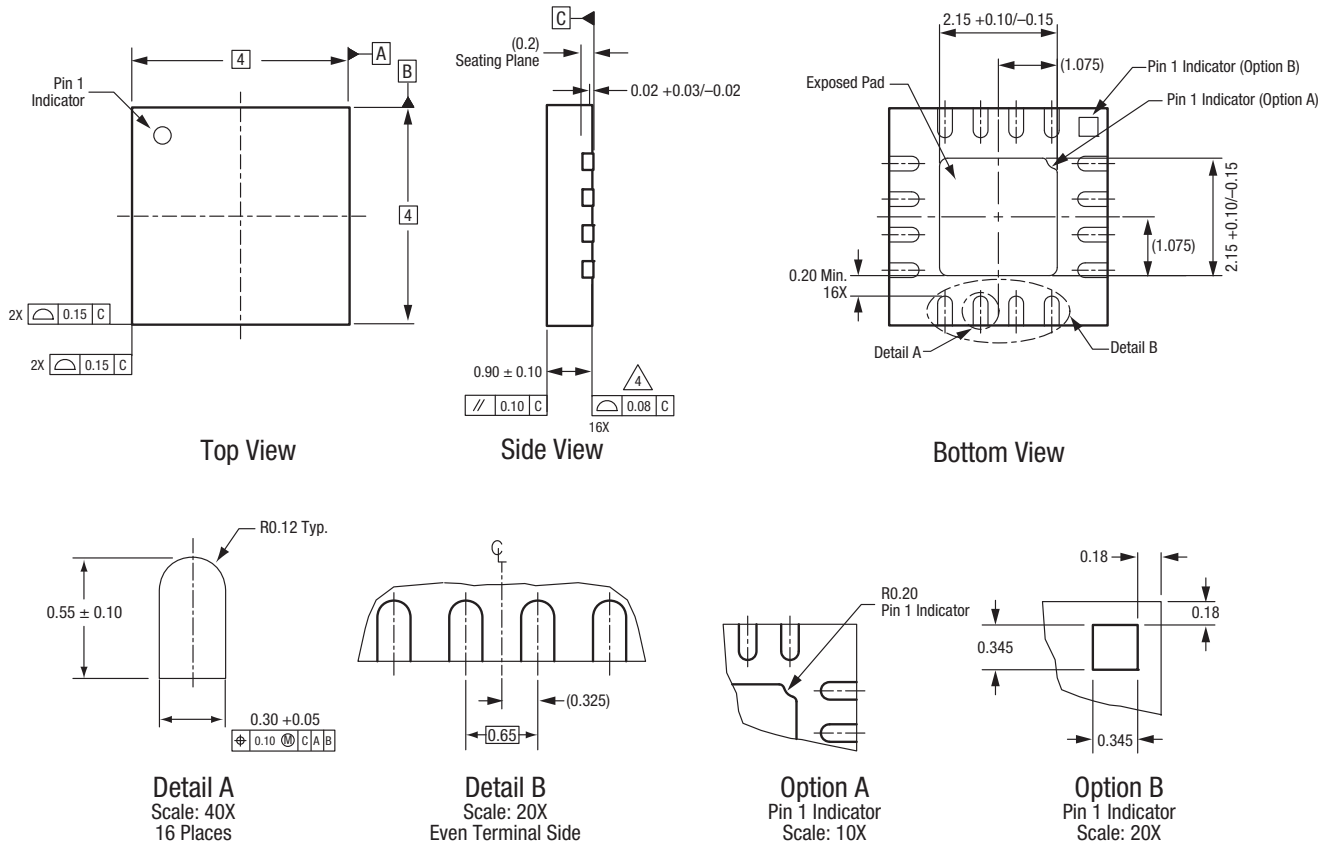

Figure 26. Typical Case Markings

**DATA SHEET • SKY12208-306LF: 50 W PIN DIODE SPDT SWITCH**



All measurements are in millimeters.  
 Dimensioning and tolerancing according to ASME Y14.5M-1994.  
 Coplanarity applies to the exposed heat sink slug as well as the terminals.  
 Package may have option A or option B pin 1 indicator.

S2400

**Figure 27. SKY12208-306LF 16-Pin QFN Package Dimensions**

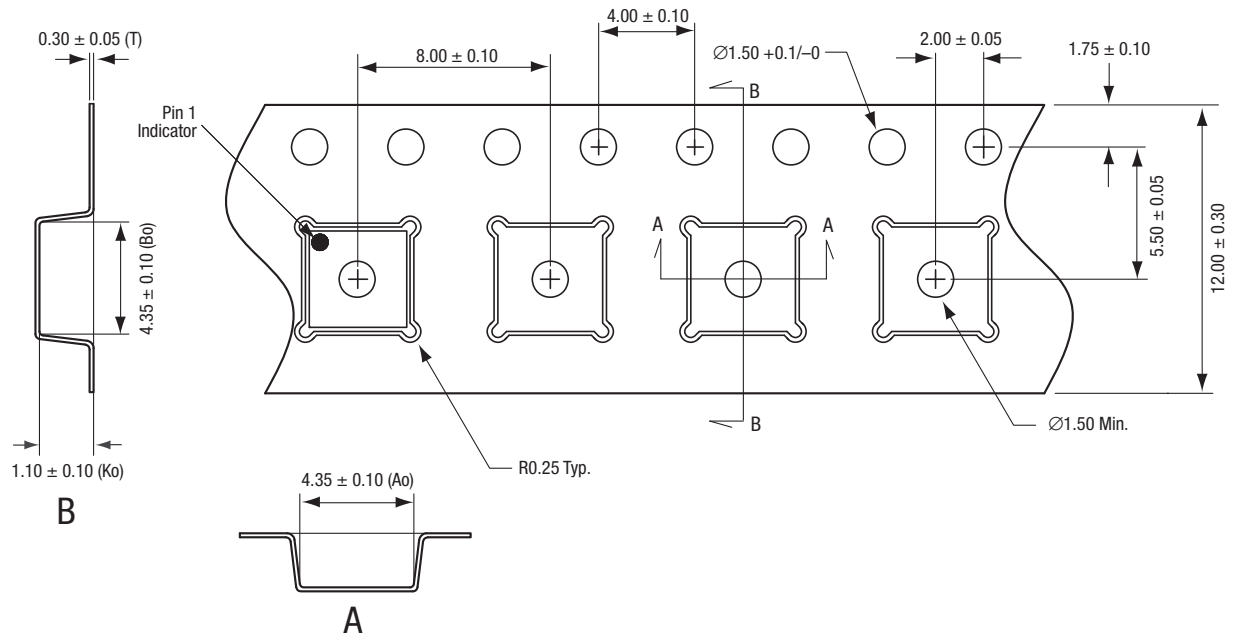

- Notes:
1. Carrier tape material: black conductive polystyrene, non-bakeable
  2. Cover tape material: transparent conductive HSA
  3. Cover tape size: 9.2 mm width
  4. ESD surface resistivity is  $\geq 1 \times 10^5 \sim \leq 1 \times 10^{10}$  Ohms/square per EIA, JEDEC TNR Specification.
  5. All measurements are in millimeters

S1846

Figure 28. SKY12208-306LF Tape and Reel Dimensions