

DATA SHEET

SKY65450-92LF: 40 MHz to 1 GHz Broadband 75 Ω CATV Low-Noise Amplifier with Bypass Mode

Applications

- Terrestrial and cable set-top box
- Cable modem
- Home gateway
- Personal video recorder (PVR)
- Digital video recorder (DVR)

Features

- Small signal gain: 15 dB typical
- Best-in-class linearity
- Low noise figure: 2.9 dB typical
- Bypass mode current consumption < 5 mA
- Input/output impedance internally matched to 75 Ω
- Minimal number of external components required
- Small 6-pin SC-70 (SC-88, SOT-363) plastic SMT package



Skyworks Green™ products are compliant with all applicable legislation and are halogen-free. For additional information, refer to *Skyworks Definition of Green™*, document number SQ04-0074.

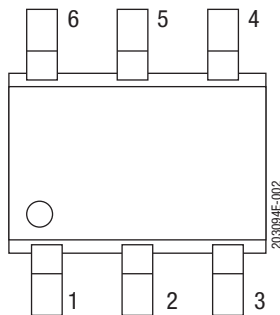
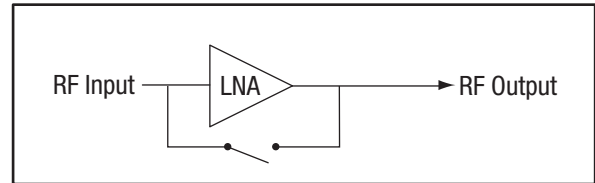

Figure 2. SKY65450-92LF Pinout (Top View)



203094E-001

Figure 1. SKY65450-92LF Block Diagram

Description

The SKY65450-92LF is a Microwave Monolithic Integrated Circuit (MMIC) front-end low-noise amplifier (LNA) designed especially for set-top box applications. The device provides high linearity, excellent gain, and best-in-class composite triple beat (CTB) and composite second order (CSO). There are minimal external components.

The SKY65450-92LF is optimized to operate between 40 MHz and 1 GHz, which makes it ideal for cable and terrestrial set-top box and home gateway applications.

The SKY65450-92LF is fabricated using SiGe BiCMOS technology. The LNA uses surface-mount technology (SMT) in a 6-pin SC-70 package.

A functional block diagram is shown in Figure 1. The pin configuration and package are shown in Figure 2. Signal pin assignments and functional pin descriptions are provided in Table 1.

Table 1. SKY65450-92LF Signal Descriptions

Pin	Name	Description	Pin	Name	Description
1	RFOUT	RF output	4	Bypass CTRL	Bypass CTRL (0 = bypass mode, 1 = gain mode, floating = gain mode)
2	VCC	Source voltage	5	GND	Ground
3	NC	Not connected	6	RFIN	RF input

Technical Description

The SKY65450-92LF is a single-stage, low-noise amplifier with a bypass switch that operates with a single 3.3 V power supply connected through an RF choke (inductor L1) to the output signal (pin 1). The bias current is set by the R1 external resistor. The device is internally RF-matched and only requires input and out blocking capacitors C1 and C2 to operate over a frequency range of 40 MHz to 1 GHz.

Electrical and Mechanical Specifications

The absolute maximum ratings of the SKY65450-92LF are provided in Table 2. The recommended operating conditions are specified in Table 3, and electrical specifications are provided in Table 4.

Table 2. SKY65450-92LF Absolute Maximum Ratings¹

Parameter	Symbol	Minimum	Maximum	Units
RF input power	P _{IN}		+20	dBm
Supply voltage	V _{CC}	1.4	3.6	V
Logic high voltage	V _{HIGH}		V _{CC}	V
Storage temperature	T _{STG}	-55	+125	°C
Junction temperature	T _J		+125	°C
Electrostatic discharge:	ESD			
Human Body Model (HBM), Class 1C			1500	V
Charged-Device Model (CDM), Class C3			1500	V

¹ Exposure to maximum rating conditions for extended periods may reduce device reliability. There is no damage to device with only one parameter set at the limit and all other parameters set at or below their nominal value. Exceeding any of the limits listed here may result in permanent damage to the device.

ESD HANDLING: *Although this device is designed to be as robust as possible, electrostatic discharge (ESD) can damage this device. This device must be protected at all times from ESD when handling or transporting. Static charges may easily produce potentials of several kilovolts on the human body or equipment, which can discharge without detection. Industry-standard ESD handling precautions should be used at all times.*

Table 3. SKY65450-92LF Recommended Operating Conditions

Parameter	Symbol	Min	Typ	Max	Units
Frequency	f	40		1000	MHz
Supply		3.1	3.3	3.5	V
Logic high voltage	V _{IH}	1.4		V _{CC}	V
Logic low voltage	V _{IL}	0		0.7	V
Ambient temperature		-40		+85	°C

Table 4. SKY65450-92LF Electrical Specifications¹
(V_{CC} = 3.3 V, Bypass Control = 3.3 V, T_c = +25 °C, f = 500 MHz, P_{IN} = -15 dBm/Tone, Unless Otherwise Noted)

Parameter	Symbol	Min	Typ	Max	Units
Main Input to Output					
Impedance I/O			75		Ω
Supply current ²	I _{CC}		42		mA
Supply current (bypass mode)	I _{CC_BYPASS}		2.5	5	mA
Gain	IS21I	14	15	16	dB
Gain (bypass mode)			-2.5		dB
Gain flatness			0.6		dB
Reverse isolation			19		dB
Noise figure	NF		2.9		dB
Noise figure (bypass mode)			3.0		dB
Third order output intercept point @ 42 mA ³	OIP3		+28.4		dBm
Third order output intercept point (bypass mode) ³			+28		dBm
Input return loss	IS11I		21		dB
Output return loss	IS22I		19		dB
Input return loss (bypass mode)			11		dB
Output return loss (bypass mode)			11		dB

¹ Performance is guaranteed only under the conditions listed in this table.

² ICC Test Condition: No RF is applied to devices and RF input/output are 75 Ω terminated.

³ OIP3 Test Condition: f₁ = 1000 MHz, f₂ = 1001 MHz.

Evaluation Board Description

The Skyworks SKY65450-92LF Evaluation Board is used to test the performance of the SKY65450-92LF low-noise amplifier. Figure 3 shows an application schematic for the SKY65450-92LF. An assembly drawing for the Evaluation Board is shown in Figure 4, and the layer detail physical characteristics are noted in Figure 5. Typical part marking is shown in Figure 6.

Capacitor C5 provides DC bias decoupling for the output stage collector voltage. Pins 6 and 1 are the RF input and output signals, respectively.

External DC blocking is provided on the input and output by capacitors C1 and C2. Ground pin 5 and the center ground pad provide the DC and RF ground. Resistor R1 is the bias resistor that can be used to optimize the current and performance of the LNA and L1 is a choke inductor which connects the Vcc to the output stage of the LNA. Pin 2 provides an enable function and has an optional RC circuit held in place by resistor R2 and capacitor C3. Pin 3 is a no connect pin and can be left floating or may be grounded.

The input and output RF traces are 75 Ω traces.

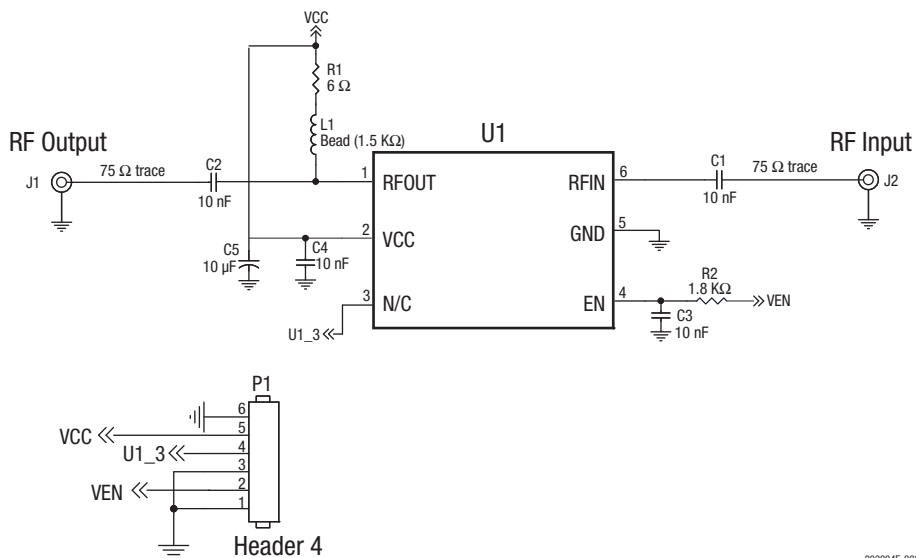

Figure 3. SKY65450-92LF Application Schematic

203094E-003

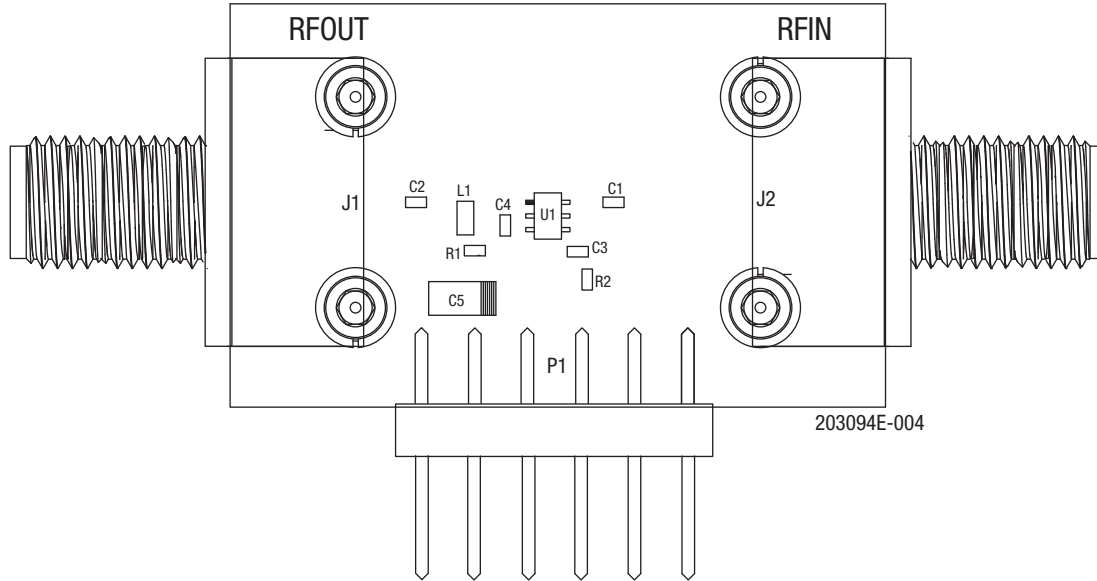

Figure 4. SKY65450-92LF Evaluation Board Assembly Diagram

75 Ω	Cross Section	Name	Thickness	Materials
W = 1.270 mm 		Tmask	0.010 mm	Solder Resist
		L1	0.025 mm	Cu – 1 oz
		Dielectric	1.500 mm	FR4
		L4	0.025 mm	Cu – 1 oz
		Bmask	0.010 mm	Solder Resist

203094E-005

Figure 5. Layer Detail Physical Characteristics

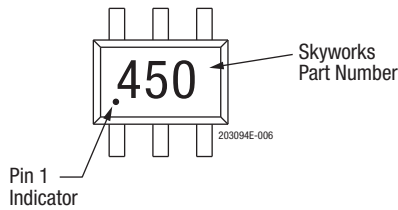

Figure 6. Typical Part Marking

Package Dimensions

The SKY65450-92LF is packaged in a standard 6-Lead SC-70 (SC-88 or SOT-363). Figure 7 shows the package dimensions. Tape and reel dimensions are shown in Figure 8.

Package and Handling Information

Instructions on the shipping container label regarding exposure to moisture after the container seal is broken must be followed. Otherwise, problems related to moisture absorption may occur when the part is subjected to high temperature during solder assembly.

The SKY65450-92LF is rated to Moisture Sensitivity Level 1 (MSL1) at 260 °C. It can be used for lead or lead-free soldering. For additional information, refer to the Skyworks Application Note: *Solder Reflow Information*, document number 200164.

Care must be taken when attaching this product, whether it is done manually or in a production solder reflow environment. Production quantities of this product are shipped in a standard tape and reel format.

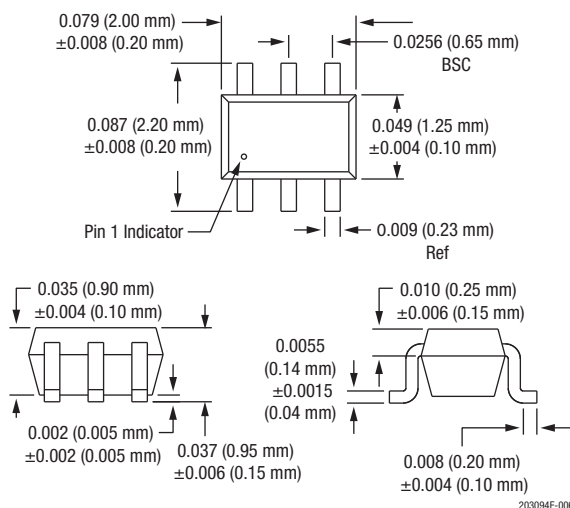
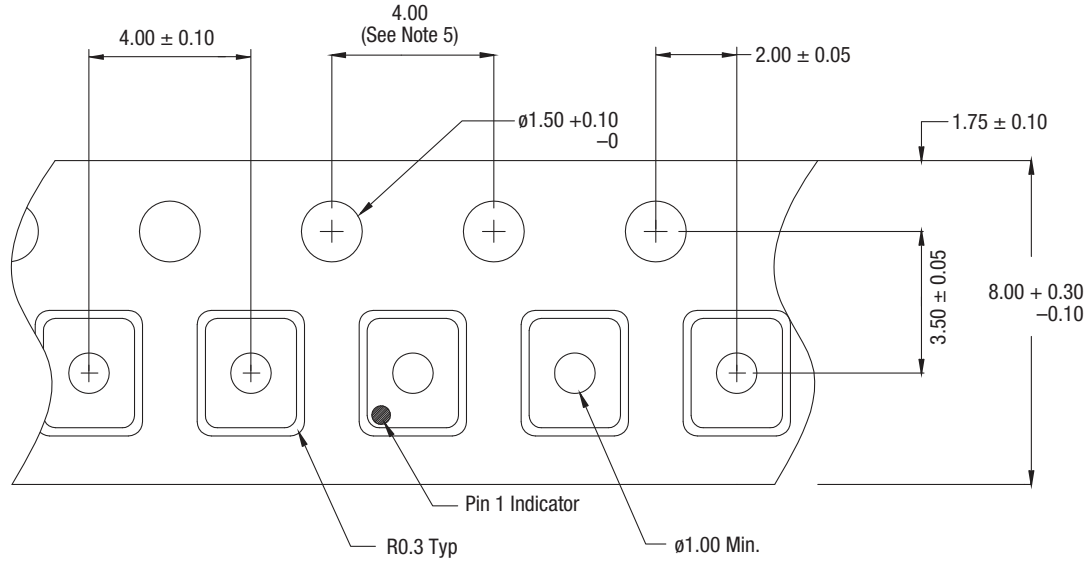
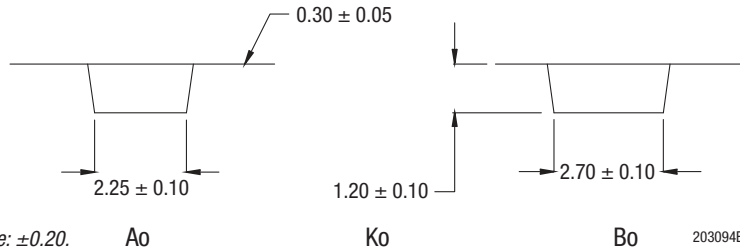

Figure 7. SKY65450-92LF Package Dimensions



Notes:

1. Carrier tape: black conductive polystyrene.
2. Cover tape: transparent conductive HSA.
3. Cover tape size: 5.4 mm width.
4. All dimensions are in millimeters.
5. 10-sprocket hole pitch cumulative tolerance: ±0.20.



203094E-007

Figure 8. SKY65450-92LF Tape and Reel Dimensions