

DATA SHEET

# SKY66317-11: 2496 to 2690 MHz Wide Instantaneous Bandwidth High-Efficiency Power Amplifier

## Applications

- FDD and TDD 4G LTE and 5G systems
- Supports 3GPP Bands 7, 38, and 41
- Driver amplifier for micro base stations and macro base stations
- Enterprise small cell and massive MIMO

## Features

- Wide instantaneous signal bandwidth: 100 MHz
- High-efficiency: PAE = 33% @ +28 dBm
- High linearity: +28 dBm with < -50 dBc ACLR with pre-distortion (100 MHz LTE, 8.5 dB PAR signal)
- High gain: 38 dB
- Excellent input and output return loss: to 50 ohm system
- Integrated active bias: performance compensated over temp
- Integrated enable ON / OFF function: PAEN = 1.7 to 2.5 V
- Single supply voltage: 5.0 V
- Pin-to-pin compatible PA family supporting major 3GPP bands
- Compact (16-pin, 5 × 5 × 1.3 mm) package (MSL3, 260 °C per JEDEC J-STD-020)



Skyworks Green™ products are compliant with all applicable legislation and are halogen-free. For additional information, refer to *Skyworks Definition of Green™*, document number SQ04-0074.

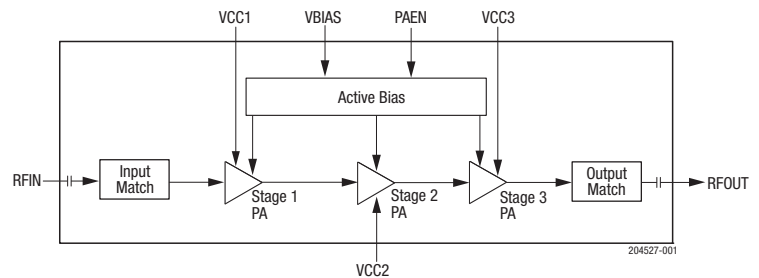

Figure 1. SKY66317-11 Block Diagram

## Description

The SKY66317-11 is a highly efficient, wide instantaneous bandwidth, fully input/output matched power amplifier (PA) with high gain and linearity. The compact 5 × 5 mm PA is designed for FDD and TDD 4G LTE and 5G systems operating from 2496 to 2690 MHz. The active biasing circuitry is integrated to compensate PA performance over temperature, voltage, and process variation.

The SKY66317-11 is part of high-efficiency, pin-to-pin compatible PA family supporting major 3GPP bands.

A block diagram of the SKY66317-11 is shown in Figure 1. The device package and pinout for the 16-pin device are shown in Figure 2. Table 1 lists the pin-to-pin compatible parts in the PA family. Signal pin assignments and functional pin descriptions are described in Table 2.

Table 1. Pin-to-Pin Compatible PA Family

Part Number	Frequency (MHz)	3GPP Band
SKY66312-11	2300 to 2400	Bands 30 and 40
SKY66317-11	2496 to 2690	Bands 7, 38, and 41
SKY66318-11	3300 to 3600	Bands 22 and 42
SKY66313-11	3400 to 3600	Bands 22, 42, and n78
SKY66320-11	3600 to 3800	Bands 43 and n77
SKY66315-11	4400 to 5000	Band n79
SKY66319-11	4800 to 5000	n79 China band

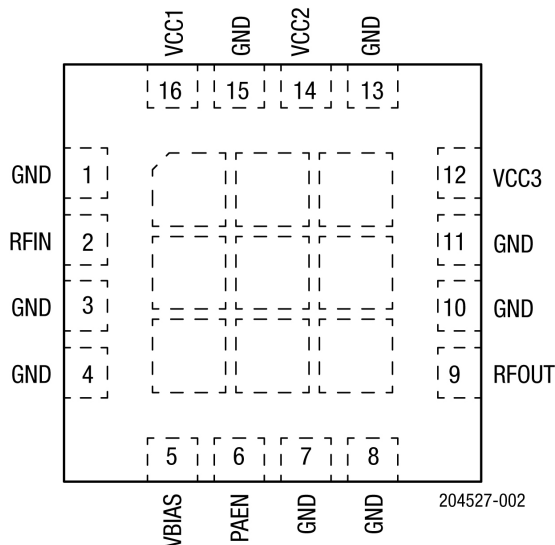

Figure 2. SKY66317-11 Pinout (Top View)

Table 2. SKY66317-11 Signal Descriptions<sup>1</sup>

Pin	Name	Description	Pin	Name	Description
1	GND	Ground	9	RFOUT	RF output port
2	RFIN	RF input port	10	GND	Ground
3	GND	Ground	11	GND	Ground
4	GND	Ground	12	VCC3	Stage 3 collector voltage
5	VBIAS	Bias voltage	13	GND	Ground
6	PAEN	PA enable	14	VCC2	Stage 2 collector voltage
7	GND	Ground	15	GND	Ground
8	GND	Ground	16	VCC1	Stage 1 collector voltage

<sup>1</sup> The center ground pad must have a low inductance and low thermal resistance connection to the application's printed circuit board ground plane.

### Technical Description

The matching circuits are contained within the device. An on-chip active bias circuit is included within the device for both input and output stages, which provides excellent gain tracking over temperature and voltage variations.

The SKY66317-11 is internally matched for maximum output power and efficiency. The input and output stages are independently supplied using the VCC1, VCC2, and VCC3 supply lines (pins 16, 14, and 12, respectively). The DC control voltage that sets the bias is supplied by the VBIAS signal (pin 5).

### Electrical and Mechanical Specifications

The absolute maximum ratings of the SKY66317-11 are provided in Table 3. Recommended operating conditions are specified in Table 4, and electrical specifications are provided in Table 5.

**Table 3. SKY66317-11 Absolute Maximum Ratings<sup>1</sup>**

Parameter	Symbol	Minimum	Maximum	Units
RF input power (CW)	PIN		+10	dBm
Supply voltage (VCC1, VCC2, VCC3, VBIAS)	Vcc		5.5	V
PA enable <sup>2</sup>	VEN		2.8	V
Operating temperature	Tc	-40	+125	°C
Storage temperature	TST	-55	+150	°C
Junction temperature (for 106 hours MTTF)	TJ		+175	°C
Power dissipation (Tc = 110 °C, Pout = +28 dBm)	Pd		1.5	W
Device thermal resistance (Tc = 110 °C, Pout = +28 dBm)	θJC		23.9	°C/W

<sup>1</sup> Exposure to maximum rating conditions for extended periods may reduce device reliability. There is no damage to device with only one parameter set at the limit and all other parameters set at or below their nominal value. Exceeding any of the limits listed here may result in permanent damage to the device.

---

**ESD HANDLING:** *Although this device is designed to be as robust as possible, electrostatic discharge (ESD) can damage this device. This device must be protected at all times from ESD when handling or transporting. Static charges may easily produce potentials of several kilovolts on the human body or equipment, which can discharge without detection. Industry-standard ESD handling precautions should be used at all times.*

---

**Table 4. SKY66317-11 Recommended Operating Conditions**

Parameter	Symbol	Min	Typ	Max	Units
Supply voltage (VCC1, VCC2, VCC3, VBIAS)	Vcc1, Vcc2, Vcc3, VBIAS	4.75	5	5.25	V
PA enable:	PAEN				
ON		1.7	2.0	2.5	V
OFF			0	0.5	V
PA enable current	IENABLE		1	12	µA
Operating frequency	f	2496		2690	MHz
Operating temperature	Tc	-40	+25	+110	°C

**Table 5. SKY66317-11 Electrical Specifications<sup>1</sup>**

**(Vcc1 = Vcc2 = Vcc3 = VBIAS = 5 V, PAEN = 2.0 V, f = 2593 MHz, Tc = +25 °C, Input / Output Load = 50 ohms, Unless Otherwise Noted)**

Parameter	Symbol	Test Condition	Min	Typ	Max	Units
Frequency	f		2496		2690	MHz
Small signal gain	IS21I	PIN = -30 dBm	35.5	36.5		dB
Gain @ +28 dBm	IS21I@+28dBm	POUT = +28 dBm	36	38		dB
Input return loss	IS11I	PIN = -20 dBm	10	13		dB
Output return loss	IS22I	PIN = -20 dBm	7	8.4		dB
Reverse isolation <sup>2</sup>	IS12I	PIN = -30 dBm		50		dB
Raw ACLR	ACLR	POUT = +28 dBm (100 MHz LTE, 8.5 dB PAR signal)		-29	-27	dBc
Output power at 1 dB gain compression	P1dB	CW, reference to small signal gain (PIN = -30 dBm)	+33	+35.0		dBm
Output power at 3 dB gain compression	P3dB	CW, reference to small signal gain (PIN = -30 dBm)	+35	+35.6		dBm
2 <sup>nd</sup> harmonic	2fo	CW, POUT = +28 dBm		-45		dBc
3 <sup>rd</sup> harmonic	3fo	CW, POUT = +28 dBm		-39		dBc
Power-added efficiency	PAE	CW, POUT = +28 dBm	29	33		%
Quiescent current	IcQ	No RF signal		90	125	mA
Load mismatch stress with no permanent degradation or failure <sup>2</sup>		VCC = +5 V, POUT = +28 dBm with 20 MHz LTE signal, PAR = 8.5 dB		10:1		VSWR
RF turn-on time <sup>3</sup>	ton	Measured from 50% PA enable voltage level to 90% of RF amplitude		1.7	3	us

<sup>1</sup> Performance is guaranteed only under the conditions listed in this table.

<sup>2</sup> Not tested in production. Verified by design.

<sup>3</sup> RF turn-on time is measured from the time the PA enable reaches 50% of PA enable "on" level to the time at which the RF output power achieves 90% of the average steady-state "on" level.

### Typical Performance Characteristics

(VCC1 = VCC2 = VCC3 = VBIA5 = 5 V, PAEN = 2.0 V, f = 2593 MHz, TC = +25 °C, Input / Output Load = 50 ohms, Unless Otherwise Noted)

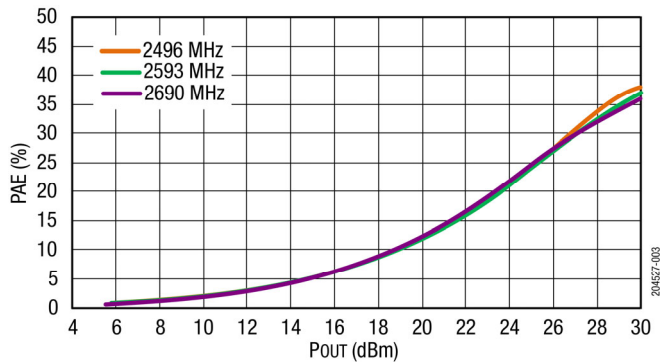

Figure 3. PAE vs Pout Across Frequency

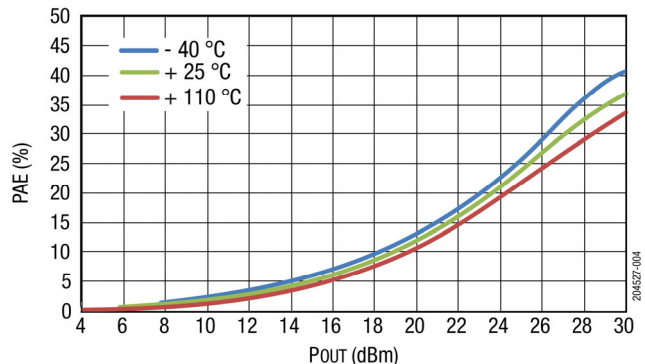

Figure 4. PAE vs Pout Across Temperature

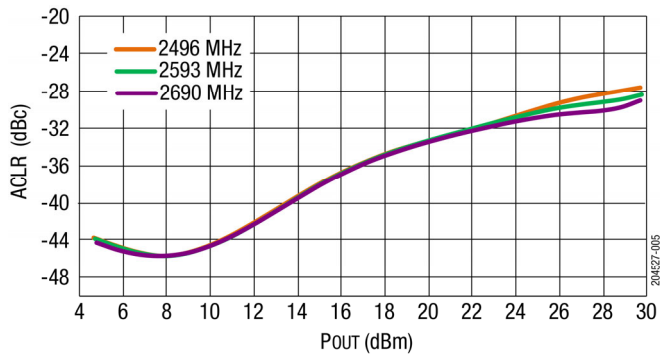

Figure 5. LTE 5x20 MHz ACLR1 vs Pout Across Frequency

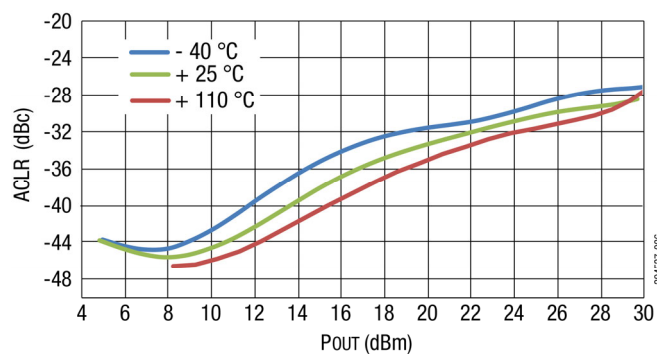

Figure 6. LTE 5x20 MHz ACLR1 vs Pout Across Temperature

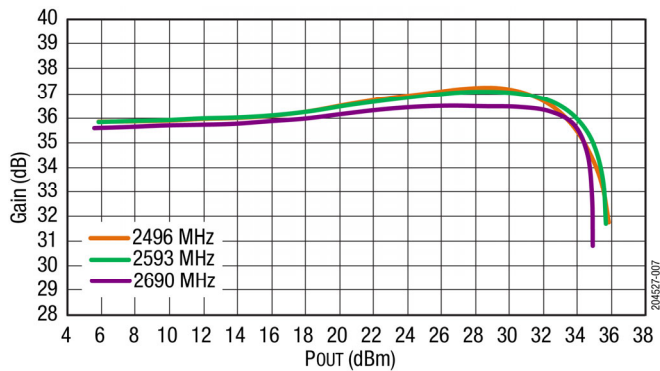

Figure 7. Gain vs Pout Across Frequency

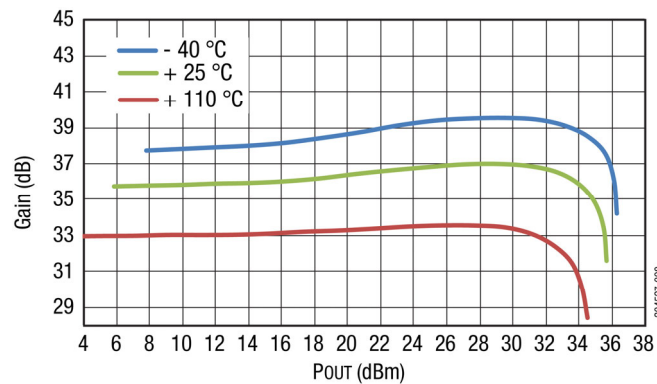

Figure 8. Gain vs Pout Across Temperature

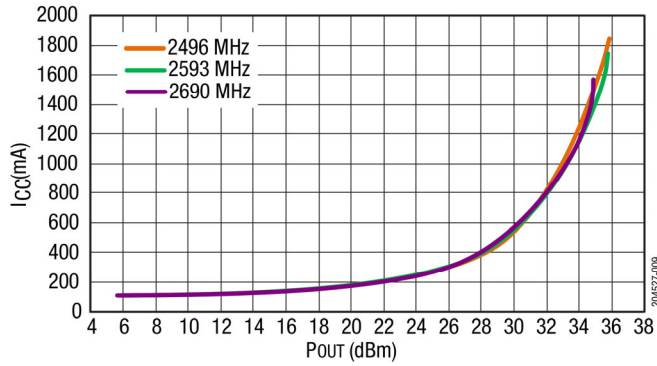

Figure 9. IOP vs Pout Across Frequency

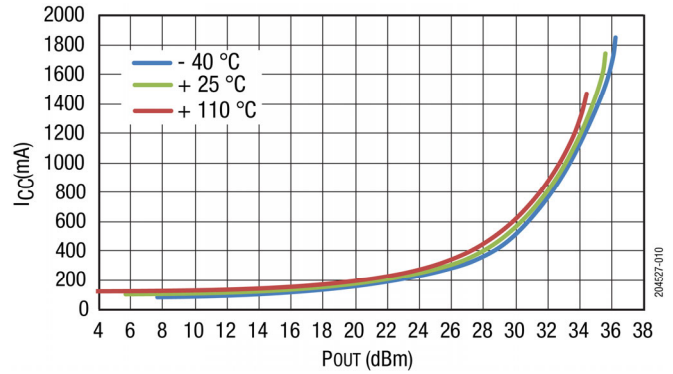

Figure 10. IOP vs Pout Across Temperature

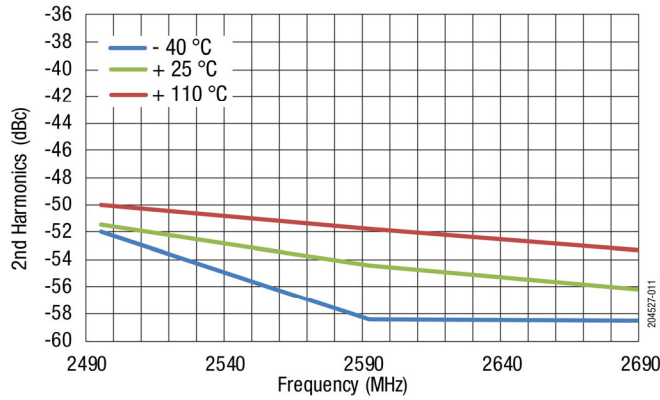

Figure 11. 2nd Harmonic @ +28 dBm (CW) vs Frequency Across Temperature

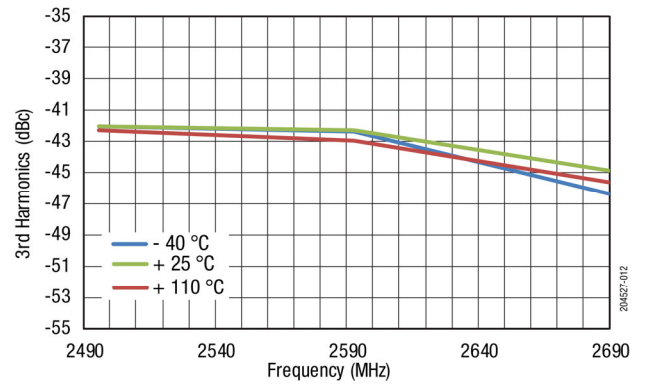

Figure 12. 3rd Harmonic @ +28 dBm (CW) vs Frequency Across Temperature

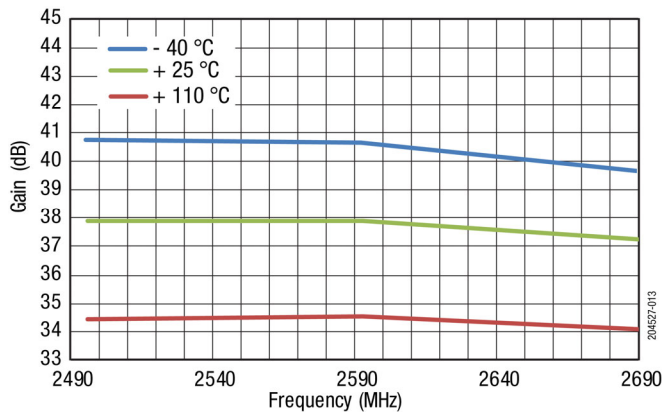

Figure 13. Small Signal Gain vs Frequency Across Temperature

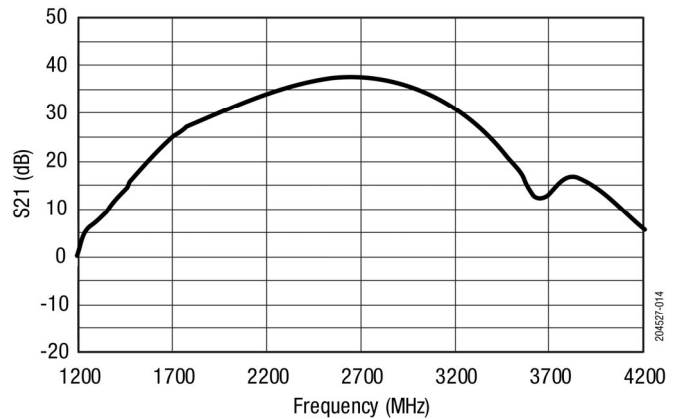
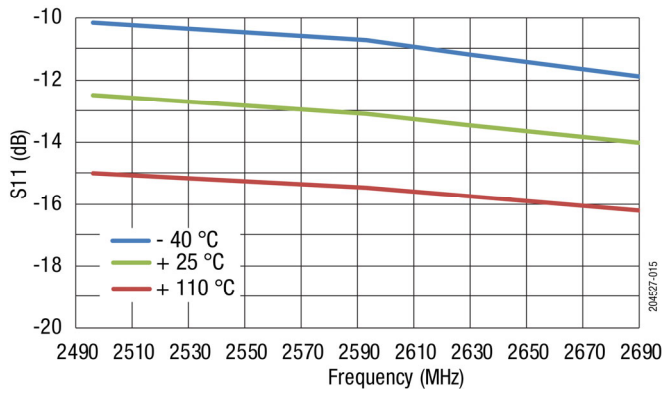
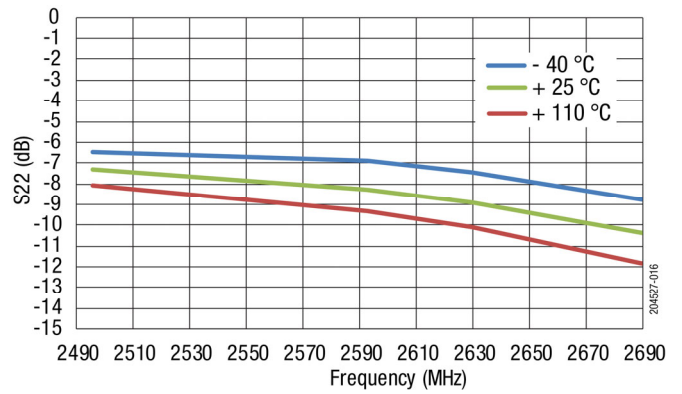

Figure 14. Wide-Band S21 vs Frequency



**Figure 15. S11 vs Frequency Across Temperature (PIN = -20 dBm)**



**Figure 16. S22 vs Frequency Across Temperature (PIN = -20 dBm)**

## Evaluation Board Description

The SKY66317-11 Evaluation Board is used to test the performance of the SKY66317-11 PA. An application schematic is provided in Figure 17. Table 6 provides the Bill of Materials (BoM) list for Evaluation Board components.

An assembly drawing for the Evaluation Board is shown in Figure 18. Board layer details are shown in Figure 19. Layer detail physical characteristics are noted in Figure 20.

## Evaluation Board Test Procedure

### Turn-On Sequence

1. Connect 50 ohm test equipment or load to the input and output RF ports of the Evaluation Board.
2. Connect the DC ground.
3. Connect all VCCs and VBIAS lines to a +5 V supply. Connect PAEN to a 2.0 V supply.
4. Without applying RF, turn on the 5 V supply, then turn on the 2 V PAEN.
5. Apply RF signal data at -30 dBm and observe that the gain of the device is approximately 38 dB. Begin measurements.

### Turn-Off Sequence

1. Turn off the RF input to the device.
2. Turn off PAEN (set to 0 V).
3. Turn off all VCCs and VBIAS.

**NOTE:** It is important to adjust the VCC voltage sources so that +5 V is measured at the board. High collector currents drop the collector voltage significantly if long leads are used. Adjust the bias voltage to compensate.

## Circuit Design Considerations

The following design considerations are general in nature and must be followed regardless of final use or configuration:

- Paths to ground should be made as short as possible.
- The ground pad of the SKY66317-11 has special electrical and thermal grounding requirements. This pad is the main thermal conduit for heat dissipation. Because the circuit board acts as the heat sink, it must shunt as much heat as possible from the device.

Therefore, design the connection to the ground pad to dissipate the maximum wattage produced by the circuit board. Multiple vias to the grounding layer are required.

**NOTE:** A poor connection between the ground pad and ground increases junction temperature ( $T_J$ ), which reduces the life of the device.



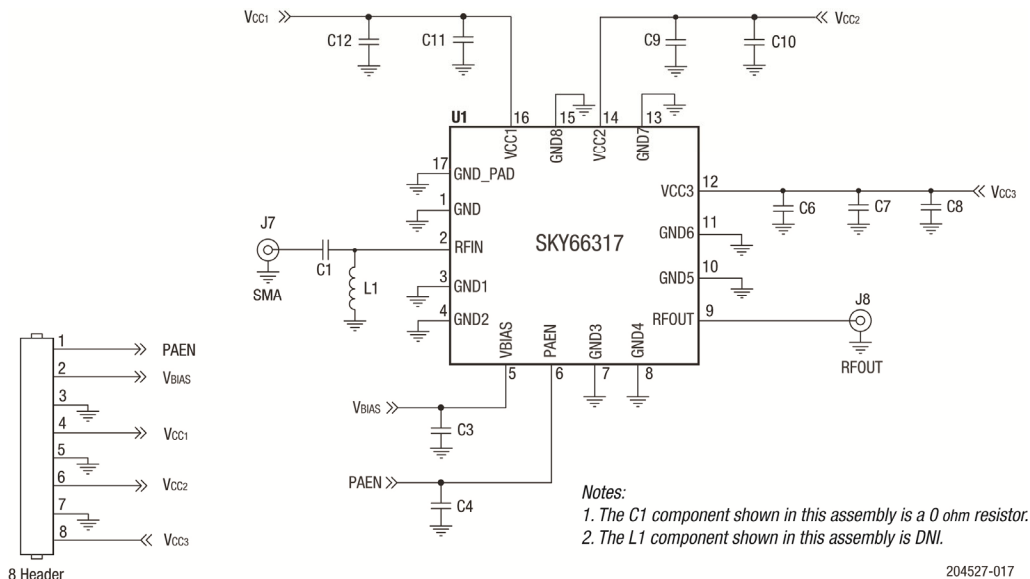

Figure 17. SKY66317-11 Application Schematic

Table 6. SKY66317-11 Evaluation Board Bill of Materials (BOM)

Component	Description	Size
C1	Resistor, 0 ohms, 0.063 W	0402
C3, C6	Ceramic capacitor, 1 μF, ±10%, 10 V	0402
C4, C7, C9	Ceramic capacitor, 3300 pF, U2J, ±5%, 10 V	0402
C8, C10, C12	Ceramic capacitor, 10 uF, X7R, ±10%, 16 V	1206
C11	Ceramic capacitor, 0.1 uF, X7R, ±10%, 16 V	0402
L1	DNI	
TW21-D690-XXXX	Evaluation Board	

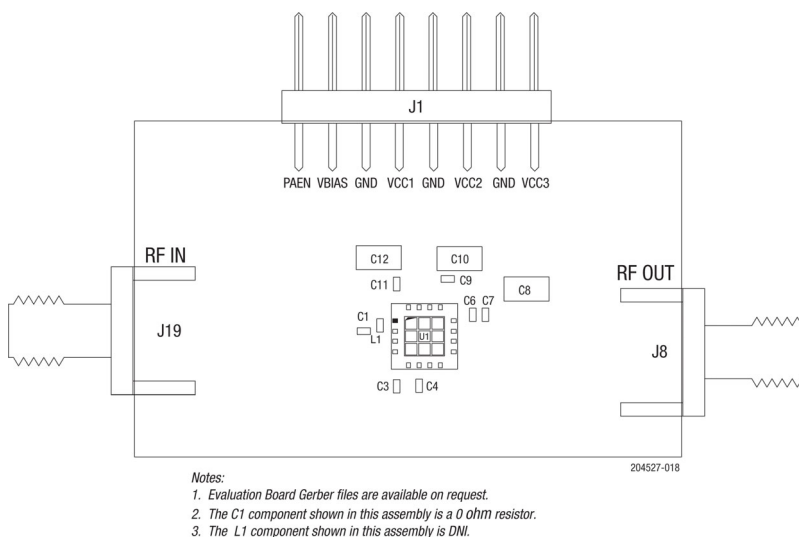

Figure 18. SKY66317-11 Evaluation Board Assembly Drawing

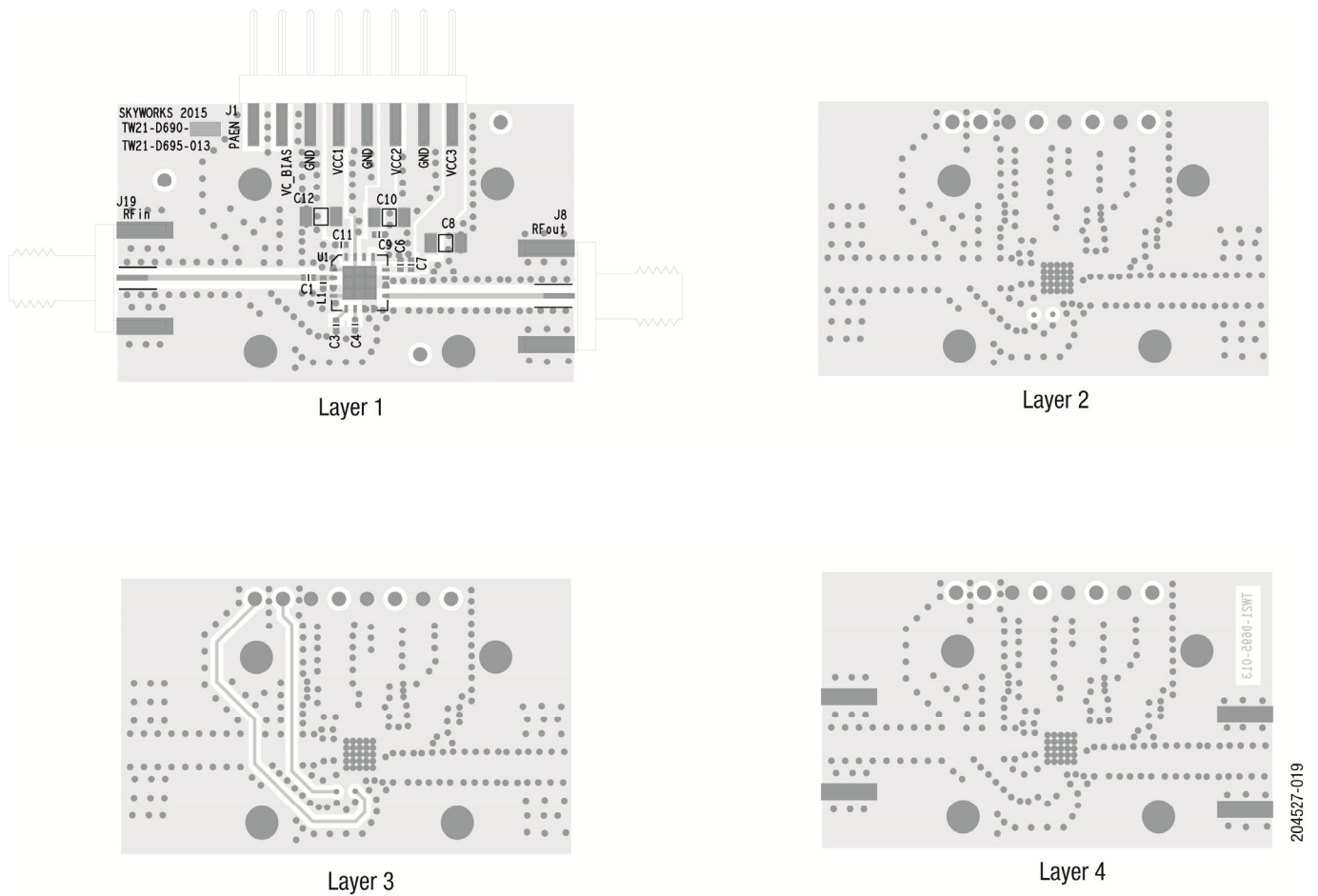

Figure 19. SKY66317-11 Board Layer Detail

50 Ohm	Cross Section	Name	Thickness (mm)	Materials
W = 0.500 mm		TMask	0.010	Solder Resist
		L1	0.035	Cu, 1 oz.
		Dielectric	0.250	R04350
		L2	0.035	Cu, 1 oz.
		Dielectric	0.350	FR4
		L3	0.035	Cu, 1 oz.
		Dielectric	0.250	FR4
		L4	0.035	Cu, 1 oz.
		BMask	0.010	Solder Resist

204527-020

Figure 20. SKY66317-11 Layer Detail Physical Characteristics

## Application Circuit Notes

**Center Ground.** It is extremely important to sufficiently ground the bottom ground pad of the device for both thermal and stability reasons. Multiple small vias are acceptable and work well under the device if solder migration is an issue.

**GND (pins 1, 3, 4, 7, 8, 10, 11, 13, and 15).** Attach all ground pins to the RF ground plane with the largest diameter and lowest inductance via that the layout allows. Multiple small vias are acceptable and will work well under the device if solder migration is an issue.

**VBIAS (pin 5).** The bias supply voltage for each stage, nominally set to +5 V.

**RFOUT (pin 9).** Amplifier RF output pin ( $Z_0 = 50$  ohms). The module includes an internal DC blocking capacitor. All impedance matching is provided internal to the module.

**VCC1, VCC2, and VCC3 (pin 16, 15, and 12, respectively).** Supply voltage for each stage collector bias is nominally set to 5 V. The evaluation board has inductors L1 and L2. These are place holders and should be populated with 0 ohm resistors. Bypass and decoupling capacitors C6 through C12 should be placed in the approximate location shown on the evaluation board assembly drawing, although exact placement is not critical.

**RFIN (pin 2).** Amplifier RF input pin ( $Z_0 = 50$  ohms). All impedance matching is provided internal to the module.

## Package Dimensions

Typical part marking for the device is shown in Figure 21. The PCB layout footprint for the SKY66317-11 is shown in Figure 22. Package dimensions are shown in Figure 23, and tape and reel dimensions are provided in Figure 24.

## Package and Handling Information

Since the device package is sensitive to moisture absorption, it is baked and vacuum packed before shipping. Instructions on the shipping container label regarding exposure to moisture after the container seal is broken must be followed. Otherwise, problems related to moisture absorption may occur when the part is subjected to high temperature during solder assembly.

The SKY66317-11 is rated to Moisture Sensitivity Level 3 (MSL3) at 260 °C. It can be used for lead or lead-free soldering. For additional information, refer to Skyworks Application Note, *PCB Design and SMT Assembly/Rework Guidelines for MCM-L Packages*, document number 101752.

Care must be taken when attaching this product, whether it is done manually or in a production solder reflow environment. Production quantities of this product are shipped in a standard tape and reel format.

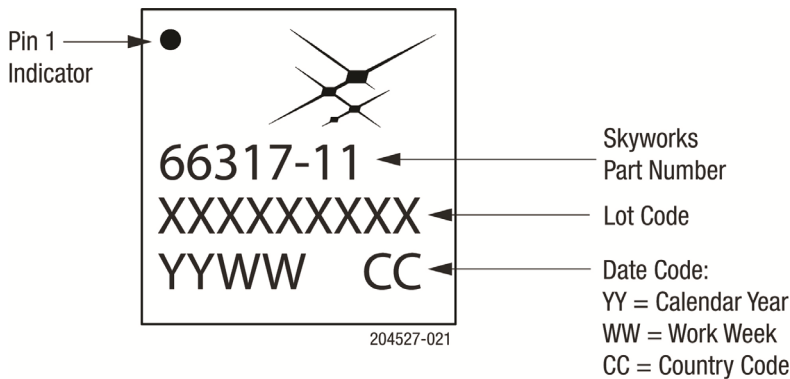
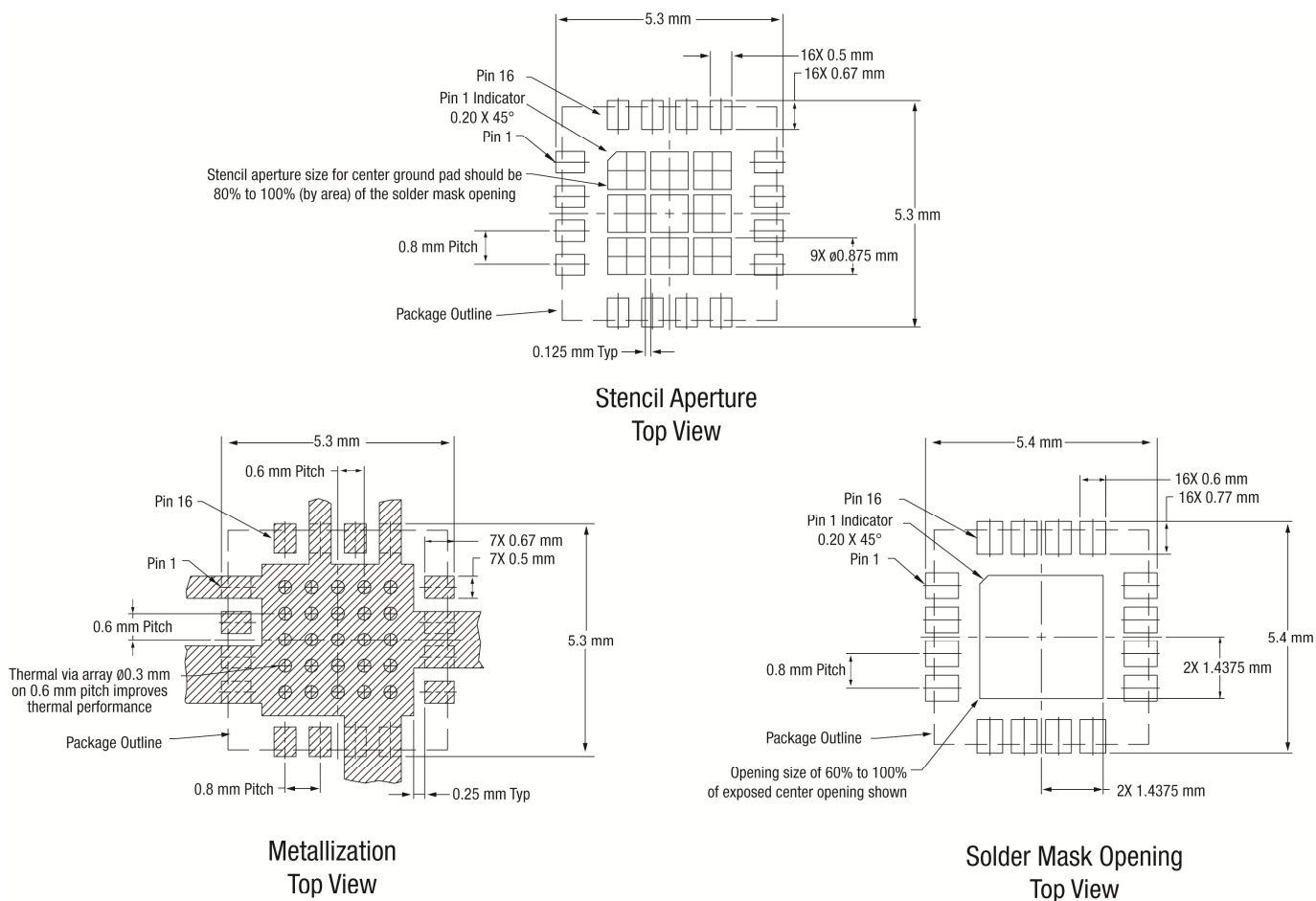

Figure 21. SKY66317-11 Typical Part Marking



Notes:

1. Thermal vias should be resin filled and capped in accordance with IPC-4761 type VII vias.
2. Recommended Cu thickness is 30 to 35 um.

204527-022

Figure 22. SKY66317-11 PCB Layout Footprint

**DATA SHEET • SKY66317-11: 2496 to 2690 MHz Wide Instantaneous Bandwidth High-Efficiency PA**

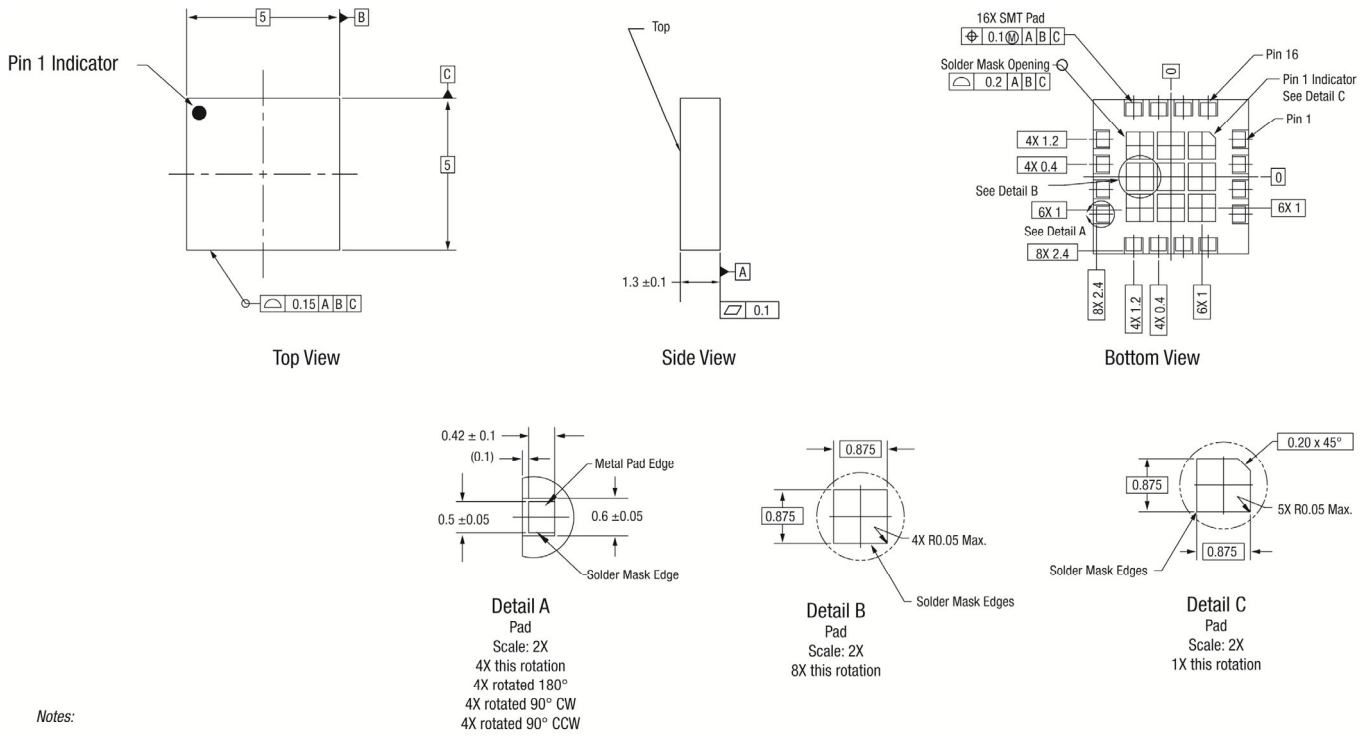

**Notes:**

1. Dimensions are in millimeters (unless otherwise specified).
2. Dimensions and tolerances are in accordance with ASME Y14.5M-1994.

204527-023

**Figure 23. SKY66317-11 Package Dimensions**

**DATA SHEET • SKY66317-11: 2496 to 2690 MHz Wide Instantaneous Bandwidth High-Efficiency PA**

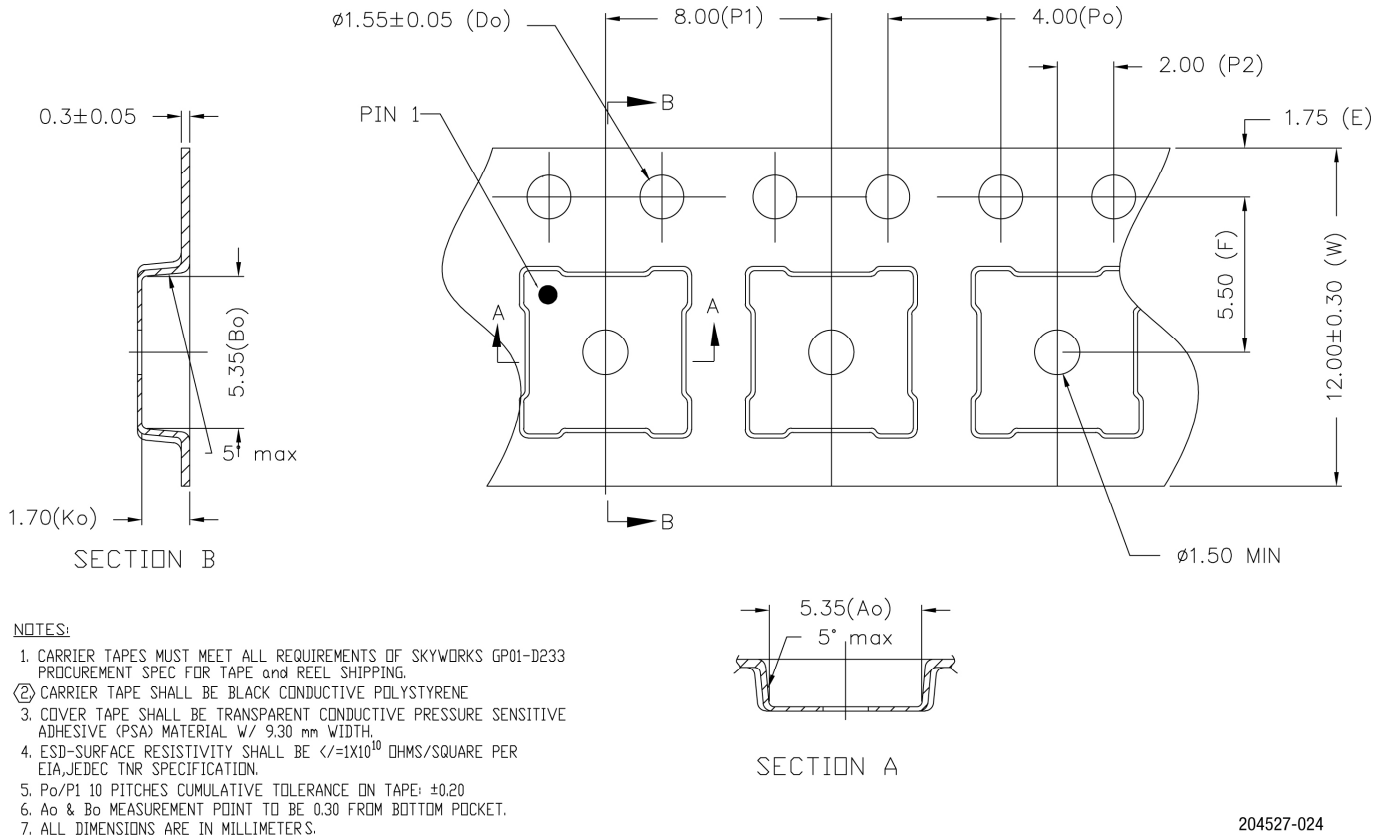

**Figure 24. SKY66317-11 Tape and Reel Dimensions**

204527-024