

DATA SHEET

# SKY67159-396LF: 200 to 3800 MHz Broadband Low-Noise Amplifier

## Applications

- FDD and TDD 2G/3G/4G LTE systems
- Receive LNA for micro-cell, macro-cell, and small-cell base stations
- Active antenna array and massive MIMO
- Land mobile radios and military communications
- Low-noise broadband gain block and driver amplifier

## Features

- Excellent broadband flat gain performance
- Low noise figure
- High IP3 performance over voltage
- Single matching circuit for 200 to 3800 MHz
- Adjustable supply current from 30 to 100 mA
- Flexible bias voltage: 3 to 5 V
- Fast rise/fall time ENABLE function suitable for TDD application
- Temperature and process-stable active bias up to +105 °C
- Miniature DFN (8-pin, 2 x 2 mm) package (MSL1 @ 260 °C per JEDEC J-STD-020)



Skyworks Green™ products are compliant with all applicable legislation and are halogen-free. For additional information, refer to *Skyworks Definition of Green™*, document number SQ04-0074.

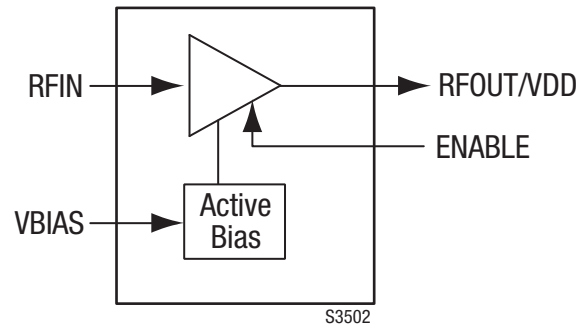

Figure 1. SKY67159-396LF Block Diagram

## Description

The SKY67159-396LF is an ultra-broadband low-noise amplifier with superior gain flatness and exceptional linearity.

The compact 2 x 2 mm, 8-pin Dual Flat No Lead packaged LNA is designed for FDD and TDD 2G/3G/4G LTE small-cell base stations operating from 200 to 3800 MHz.

The internal active bias circuitry provides stable performance over temperature and process variation. The device offers the ability to externally adjust supply current.

A functional block diagram is shown in Figure 1. The pin configuration and package are shown in Figure 2. Signal pin assignments and functional pin descriptions are provided in Table 1.

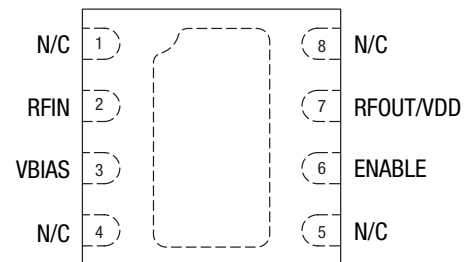

Figure 2. SKY67159-396LF Pinout (Top View)

**Table 1. SKY67159-396LF Signal Descriptions**

Pin	Name	Description	Pin	Name	Description
1	N/C	No connection. May be left open, connected to VDD, or connected to ground with no change in performance.	5	N/C	No connection. May be connected to ground with no change in performance.
2	RFIN	RF input. DC blocking capacitor required.	6	ENABLE	Enable pin. Active low = amplifier ON state
3	VBIAS	Bias voltage for input gate. External resistor sets current consumption.	7	RFOUT/VDD	RF output. Apply VDD through RF choke inductor. DC blocking capacitor required.
4	N/C	No connection. May be connected to ground with no change in performance.	8	N/C	No connection. May be connected to ground with no change in performance.

**Electrical and Mechanical Specifications**

The absolute maximum ratings of the SKY67159-396LF are provided in Table 2. Electrical specifications are provided in Tables 3 through 5.

Typical performance characteristics are illustrated in Figures 3 through 27.

**Table 2. SKY67159-396LF Absolute Maximum Ratings<sup>1</sup>**

Parameter	Symbol	Minimum	Maximum	Units
Supply voltage	VDD		5.5	V
Quiescent supply current	IcQ		100	mA
RF input power (C/W)	Pin		+21	dBm
Storage temperature	TSTG	-40	+150	°C
Operating temperature	TA	-40	+105	°C
Junction temperature	TJ		+150	°C
Electrostatic discharge:	ESD			
Charged Device Model (CDM), Class 4			1000	V
Human Body Model (HBM), Class 1A			250	V
Machine Model (MM), Class A			30	V

<sup>1</sup> Exposure to maximum rating conditions for extended periods may reduce device reliability. There is no damage to device with only one parameter set at the limit and all other parameters set at or below their nominal value. Exceeding any of the limits listed here may result in permanent damage to the device.

**ESD HANDLING:** *Although this device is designed to be as robust as possible, electrostatic discharge (ESD) can damage this device. This device must be protected at all times from ESD when handling or transporting. Static charges may easily produce potentials of several kilovolts on the human body or equipment, which can discharge without detection. Industry-standard ESD handling precautions should be used at all times.*

**Table 3. SKY67159-396LF Electrical Specifications: Thermal Data<sup>1</sup>**  
**(V<sub>DD</sub> = 3.3 V, Enable = GND, T<sub>A</sub> = +25 °C, P<sub>IN</sub> = -20 dBm, Characteristic Impedance [Z<sub>0</sub>] = 50 Ω, Unless Otherwise Noted)**

Parameter	Symbol	Test Condition	Min	Typical	Max	Units
Thermal resistance	θ <sub>JC</sub>			40		°C/W
Channel temperature @ +85 °C reference (package heat slug)		V <sub>DD</sub> = 3.3 V, I <sub>CO</sub> = 45 mA, no RF applied, dissipated power = 0.15 W		90.9		°C

<sup>1</sup> Performance is guaranteed only under the conditions listed in this table.

**Table 4. SKY67159-396LF Electrical Specifications: 700 to 2700 MHz Optimized Tuning<sup>1</sup> (1 of 2)**  
**(V<sub>DD</sub> = 3.3 V, Enable = GND, T<sub>A</sub> = +25 °C, P<sub>IN</sub> = -20 dBm, Characteristic Impedance [Z<sub>0</sub>] = 50 Ω, Unless Otherwise Noted)**

Parameter	Symbol	Test Condition	Min	Typical	Max	Units
<i>RF Specifications</i>						
Noise figure <sup>2</sup>	NF	@ 700 MHz @ 1200 MHz @ 2100 MHz @ 2700 MHz		0.95 0.97 0.98 1		dB dB dB dB
Small signal gain	IS <sub>21l</sub>	@ 700 MHz @ 1200 MHz @ 2100 MHz @ 2700 MHz		17.8 17.5 17.3 17.1		dB dB dB dB
Input return loss	IS <sub>11l</sub>	@ 700 MHz @ 1200 MHz @ 2100 MHz @ 2700 MHz		18 20 20 18		dB dB dB dB
Output return loss	IS <sub>22l</sub>	@ 700 MHz @ 1200 MHz @ 2100 MHz @ 2700 MHz		22 19 19 22		dB dB dB dB
Reverse isolation	IS <sub>12l</sub>	@ 700 MHz @ 1200 MHz @ 2100 MHz @ 2700 MHz		22 22 22 23		dB dB dB dB
Third order input intercept point	IIP <sub>3</sub>	@ 700 MHz, Δf = 1 MHz, P <sub>IN</sub> = -20 dBm/tone  @ 2700 MHz, Δf = 1 MHz, P <sub>IN</sub> = -20 dBm/tone	12  10	14.2  12.4		dBm  dBm
Third order output intercept point	OIP <sub>3</sub>	@ 700 MHz, Δf = 1 MHz, P <sub>IN</sub> = -20 dBm/tone  @ 2700 MHz, Δf = 1 MHz, P <sub>IN</sub> = -20 dBm/tone	30  27.5	32  29.5		dBm  dBm
1 dB input compression point	IP <sub>1dB</sub>	@ 700 MHz @ 2700 MHz	-1 -2	+1 0		dBm dBm
1 dB output compression point	OP <sub>1dB</sub>	@ 700 MHz @ 2700 MHz	+16 +14	+18 +16		dBm dBm

**Table 4. SKY67159-396LF Electrical Specifications: 700 to 2700 MHz Optimized Tuning<sup>1</sup> (2 of 2)**  
**(V<sub>DD</sub> = 3.3 V, Enable = GND, T<sub>A</sub> = +25 °C, P<sub>IN</sub> = -20 dBm, Characteristic Impedance [Z<sub>o</sub>] = 50 Ω, Unless Otherwise Noted)**

Parameter	Symbol	Test Condition	Min	Typical	Max	Units
<b>DC Specifications</b>						
Supply voltage	V <sub>DD</sub>			3.3		V
Quiescent current	I <sub>DD</sub>	Set with external resistor (R <sub>BIAS</sub> = 4.7 kΩ)		45		mA
Bias current	I <sub>BIAS</sub>					μA
Enable voltage: Gain mode	V <sub>EN</sub>		0		0.2	V
Power-down mode			1.5		5.5	V
Enable rise time <sup>3</sup>	t <sub>ON</sub>	@ 2700 MHz		400		ns
Enable fall time <sup>3</sup>	t <sub>OFF</sub>	@ 2700 MHz		150		ns

<sup>1</sup> Performance is guaranteed only under the conditions listed in this table.

<sup>2</sup> Connector and board loss are de-embedded.

<sup>3</sup> Tested with a 100 kHz square wave, 1000 pF capacitance-to-ground on the ENABLE pin. Switching time can be improved by reducing the value of, or eliminating, the 1000 pF capacitor on pin 6 (component M17 in Figure 19).

**Table 5. SKY67159-396LF Electrical Specifications: 3400 to 3800 MHz Optimized Tuning (1 of 2)**  
**(V<sub>DD</sub> = +3.3 V, ENABLE = LOW, I<sub>cq</sub> = 45 mA, T<sub>OP</sub> = +25 °C, P<sub>IN</sub> = -20 dBm, Optimized for 3400 to 3800 MHz Operation, Unless Otherwise Noted)**

Parameter	Symbol	Test Condition	Min	Typical	Max	Units
<b>RF Specifications</b>						
Noise figure	NF	@ 3400 MHz		1.2		dB
		@ 3600 MHz		1.25		dB
		@ 3800 MHz		1.3		dB
Small signal gain	IS21I	@ 3400 MHz		16.8		dB
		@ 3600 MHz		16.7		dB
		@ 3800 MHz		16.5		dB
Input return loss	IS11I	@ 3400 MHz		24		dB
		@ 3600 MHz		30		dB
		@ 3800 MHz		30		dB
Output return loss	IS22I	@ 3400 MHz		22		dB
		@ 3600 MHz		21		dB
		@ 3800 MHz		22		dB
Reverse isolation	IS12I	@ 3400 MHz		23		dB
		@ 3600 MHz		23		dB
		@ 3800 MHz		23		dB

**Table 5. SKY67159-396LF Electrical Specifications: 3400 to 3800 MHz Optimized Tuning (2 of 2)**  
**(VDD = +3.3 V, ENABLE = LOW, Icq = 45 mA, Top = +25 °C, PIN = -20 dBm, Optimized for 3400 to 3800 MHz Operation, Unless Otherwise Noted)**

Parameter	Symbol	Test Condition	Min	Typical	Max	Units
<i>RF Specifications</i>						
Third order input intercept point	IIP3	@ 3400 MHz, $\Delta f = 1$ MHz, PIN = -20 dBm/tone	9	11.4		dBm
		@ 3800 MHz, $\Delta f = 1$ MHz, PIN = -20 dBm/tone	8	10.9		dBm
Third order output intercept point	OIP3	@ 3400 MHz, $\Delta f = 1$ MHz, PIN = -20 dBm/tone	25	28.2		dBm
		@ 3800 MHz, $\Delta f = 1$ MHz, PIN = -20 dBm/tone	24	27.4		dBm
1 dB input compression point	IP1dB	@ 3400 MHz	-3	-1		dBm
		@ 3800 MHz	-3	-1		dBm
1 dB output compression point	OP1dB	@ 3400 MHz	12	14.8		dBm
		@ 3800 MHz	12	14.5		dBm

**Typical Performance Characteristics, 700 to 2700 MHz**

(VDD = 3.3 V, Enable = GND, ICQ = 45 mA, TA = +25 °C, PIN = -20 dBm, Characteristic Impedance [Zo] = 50 Ω, Unless Otherwise Noted)

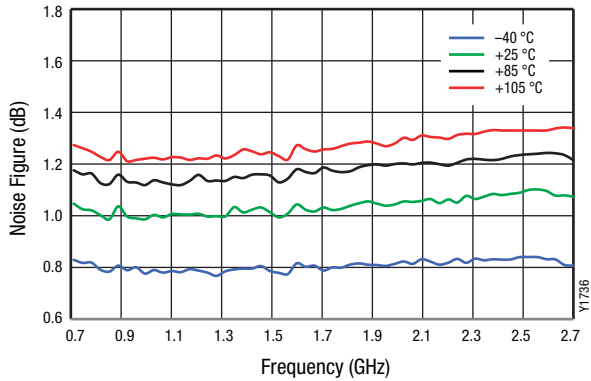

**Figure 3. Evaluation board NF vs Frequency over Temperature**

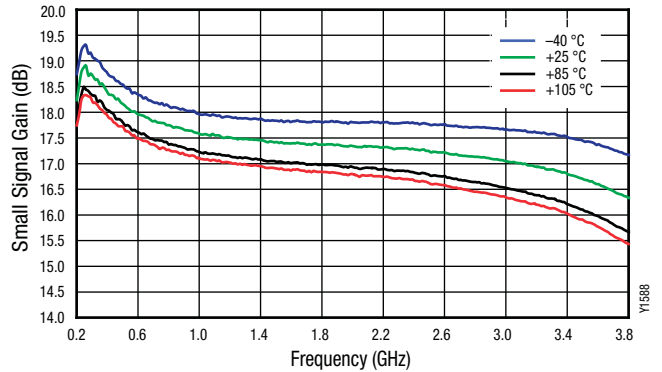

**Figure 4. Narrow Band Gain vs Frequency over Temperature**

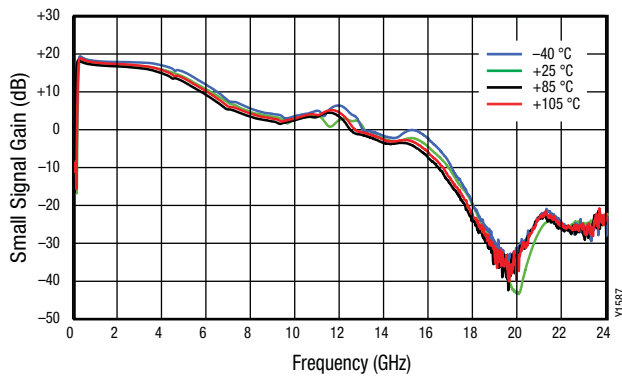

**Figure 5. Broadband Gain vs Frequency over Temperature**

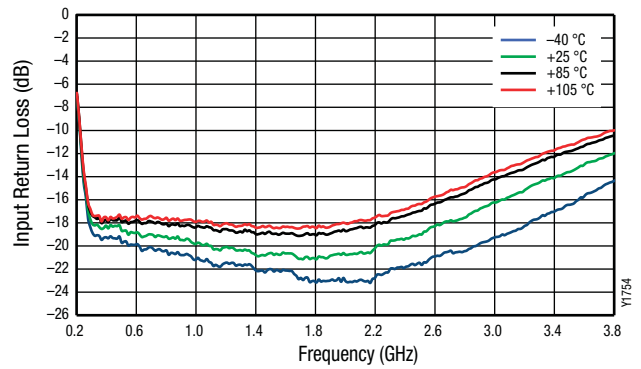

**Figure 6. Narrowband Input Return Loss vs Frequency over Temperature**

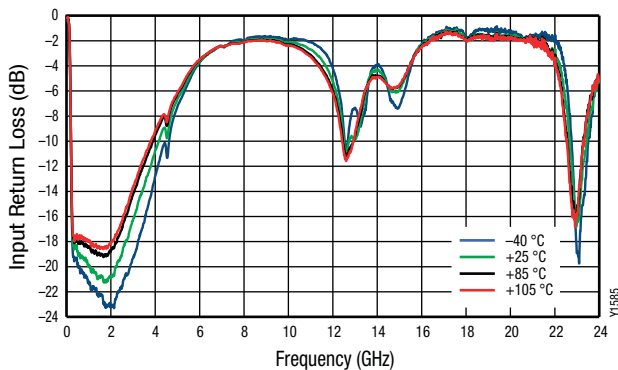

**Figure 7. Broadband Input Return Loss vs Frequency over Temperature**

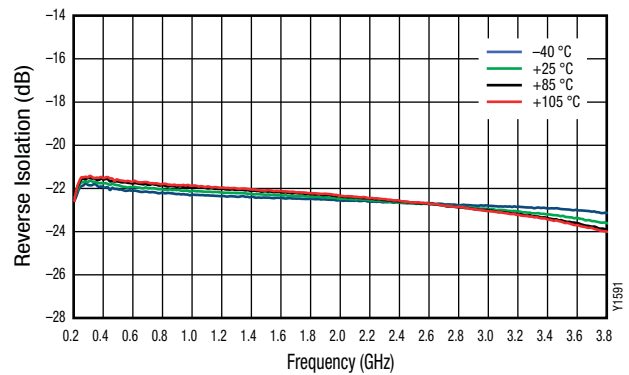

**Figure 8. Narrowband Reverse Isolation vs Frequency over Temperature**

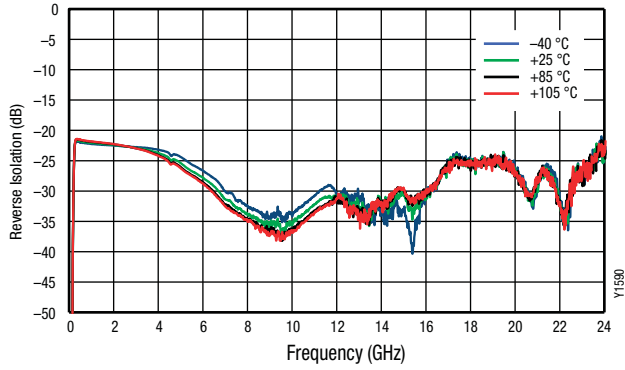

**Figure 9. Broadband Reverse Isolation vs Frequency over Temperature**

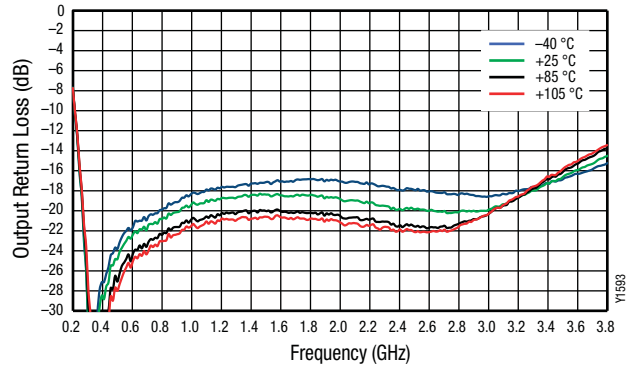

**Figure 10. Narrowband Output Return Loss vs Frequency over Temperature**

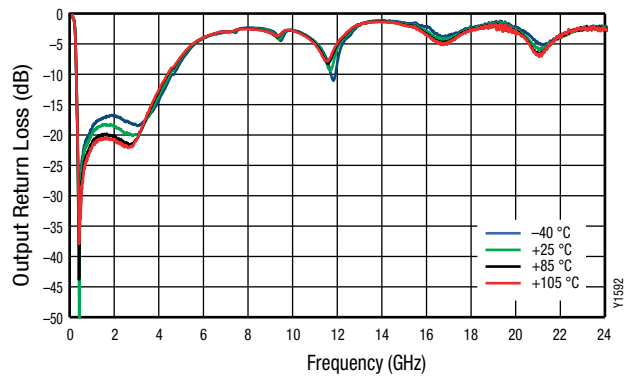

**Figure 11. Broadband Output Return Loss vs Frequency over Temperature**

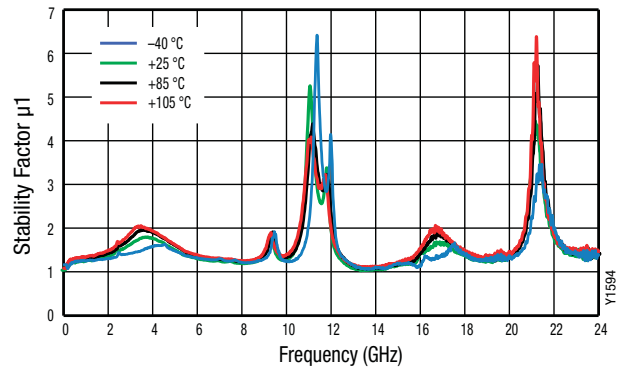

**Figure 12. Stability Factor ( $\mu_1$ ) vs Frequency over Temperature**

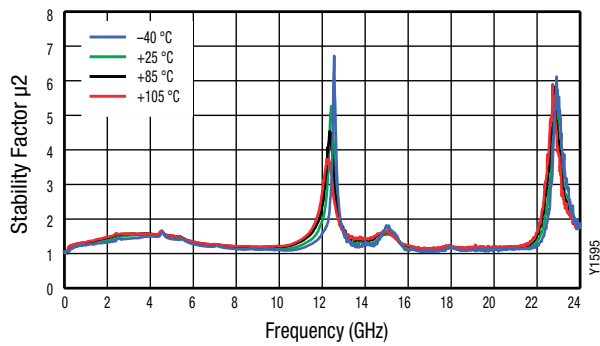

**Figure 13. Stability Factor ( $\mu_2$ ) vs Frequency over Temperature**

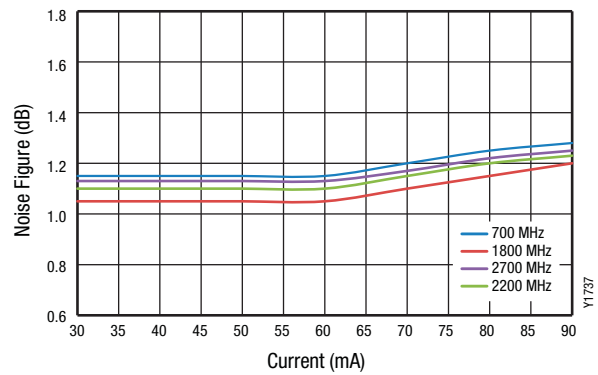

**Figure 14. Evaluation Board Noise Figure vs Quiescent Current over Frequency**

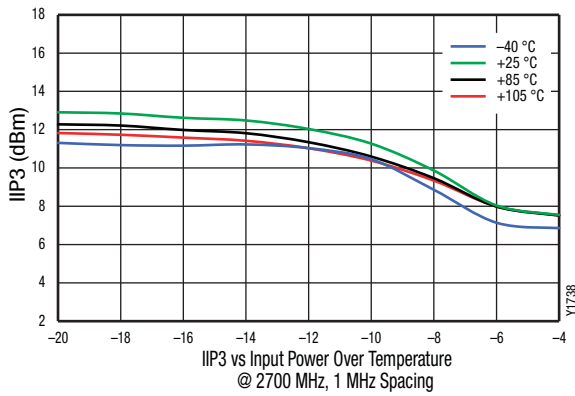

**Figure 15. OIP3 vs Input Power over Temperature (@ 2700 MHz, 1 MHz Spacing)**

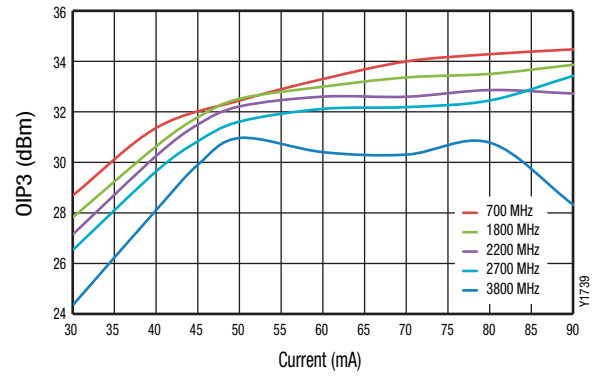
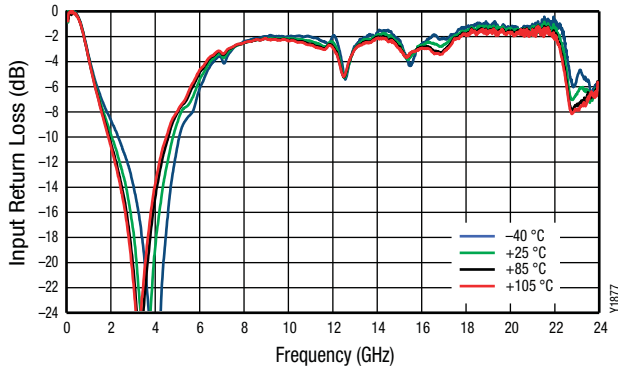

**Figure 16. OIP3 vs Quiescent Current over Frequency**



**Typical Performance Characteristics, 3400 to 3800 MHz Optimized Tuning**

(V<sub>DD</sub> = 3.3 V, Enable = GND, I<sub>CQ</sub> = 45 mA, T<sub>A</sub> = +25 °C, P<sub>IN</sub> = -20 dBm, Characteristic Impedance [Z<sub>0</sub>] = 50 Ω, Unless Otherwise Noted)



**Figure 17. Broadband Input Return Loss vs Frequency over Temperature**

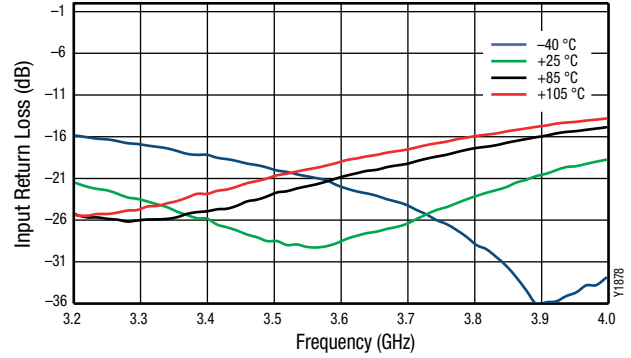

**Figure 18. Narrowband Input Return Loss vs Frequency over Temperature**

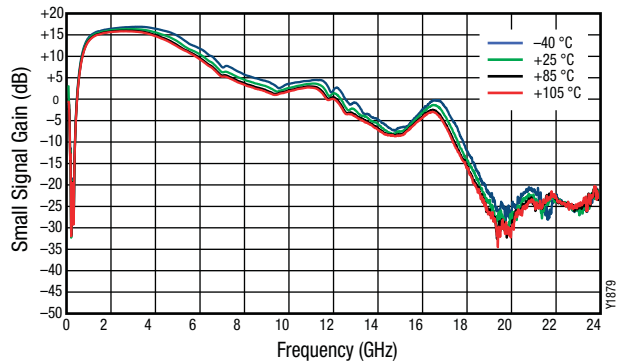

**Figure 19. Broadband Gain vs Frequency over Temperature**

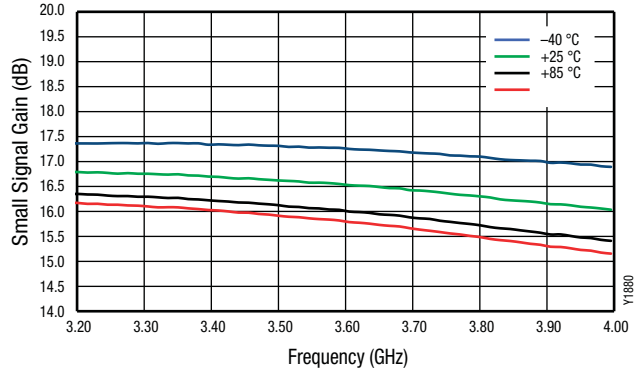

**Figure 20. Narrow Band Gain vs Frequency over Temperature**

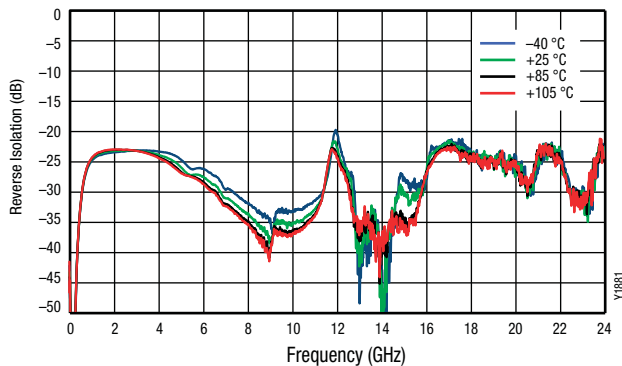

**Figure 21. Broadband Reverse Isolation vs Frequency over Temperature**

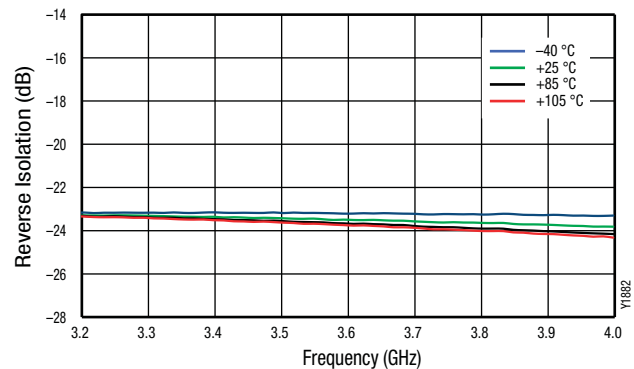

**Figure 22. Narrowband Reverse Isolation vs Frequency over Temperature**

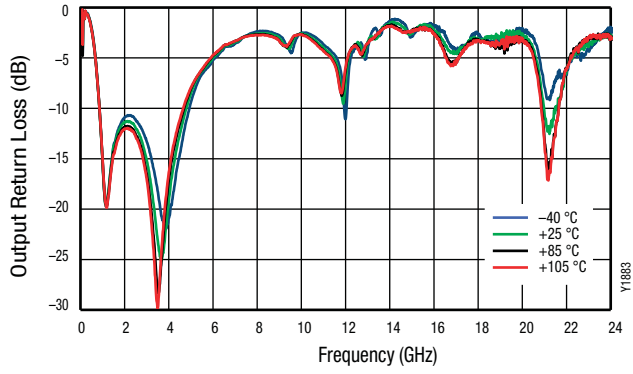

**Figure 23. Broadband Output Return Loss vs Frequency over Temperature**

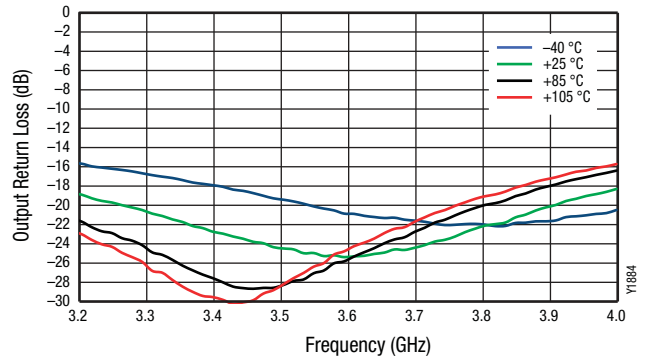

**Figure 24. Narrowband Output Return Loss vs Frequency over Temperature**

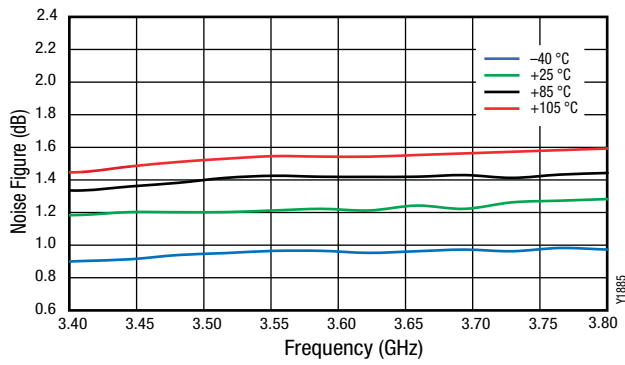

**Figure 25. Noise Figure vs Frequency**

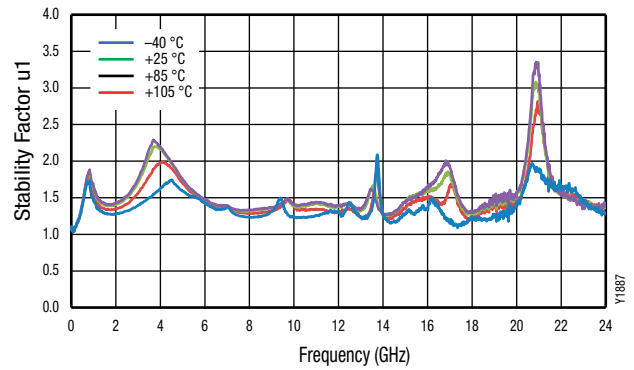

**Figure 26. Stability Factor u1 vs Frequency**

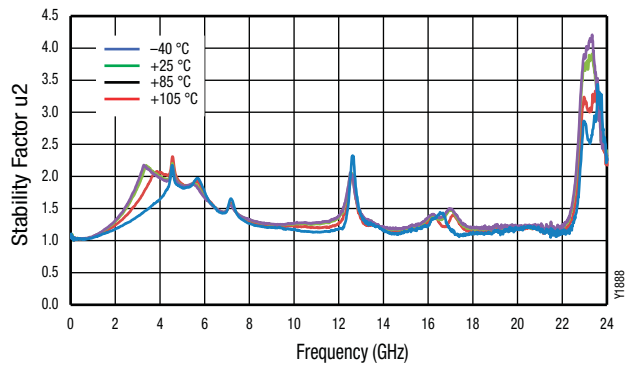

**Figure 27. Stability Factor u2 vs Frequency**

## Evaluation Board Description

The SKY67159-396LF Evaluation Board is used to test the performance of the SKY67159-396LF LNA.

An assembly drawing for the Evaluation Board is shown in Figure 28. The layer detail is provided in Figure 29. An Evaluation Board schematic (optimized for 700 to 2700 MHz) diagram is provided in Figure 30. Table 6 provides the Bill of Materials (BOM) list for the optimized frequency band (700 to 2700 MHz). An Evaluation Board schematic (optimized for 3400 to 3800 MHz) diagram is provided in Figure 31. Table 7 provides the Bill of Materials (BOM) list for the optimized frequency band (3400 to 3800 MHz).

## Package Dimensions

The PCB layout footprint for the SKY67159-396LF is provided in Figure 32. Typical part markings are shown in Figure 33. Package dimensions are shown in Figure 34, and tape and reel dimensions are provided in Figure 35.

## Package and Handling Information

Instructions on the shipping container label regarding exposure to moisture after the container seal is broken must be followed. Otherwise, problems related to moisture absorption may occur when the part is subjected to high temperature during solder assembly.

The SKY67159-396LF is rated to Moisture Sensitivity Level 1 (MSL1) at 260 °C. It can be used for lead or lead-free soldering. For additional information, refer to the Skyworks Application Note, *Solder Reflow Information*, document number 200164.

Care must be taken when attaching this product, whether it is done manually or in a production solder reflow environment. Production quantities of this product are shipped in a standard tape and reel format.

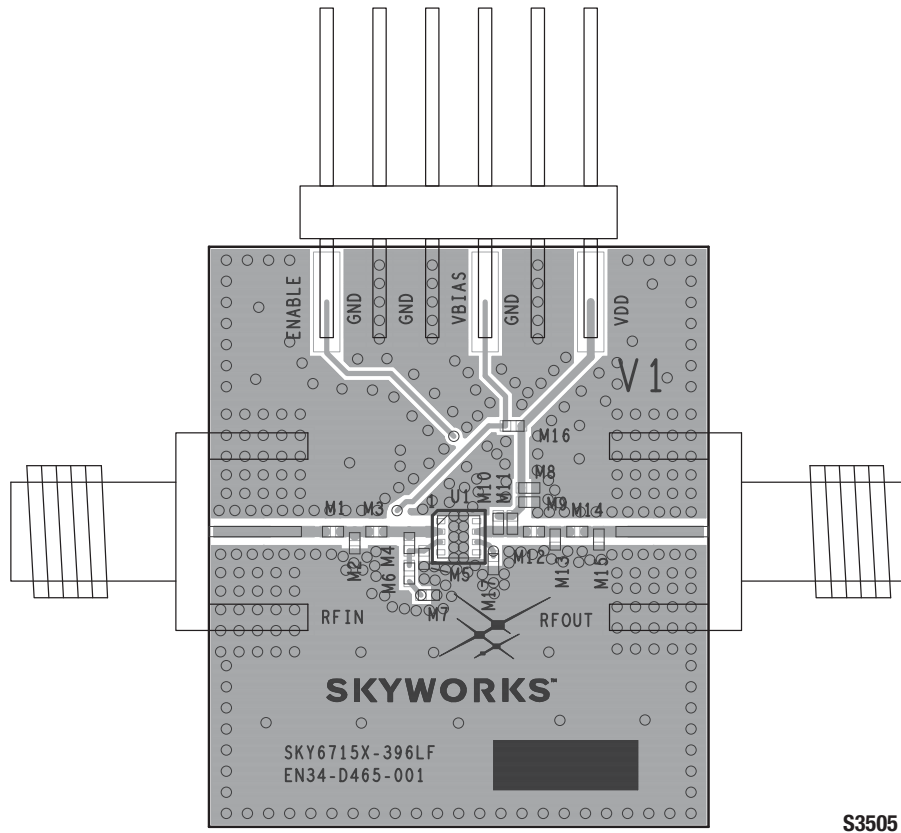

Figure 28. SKY67159-396LF Evaluation Board Assembly Diagram

Cross Section	Name	Thickness (mm)	Material
	MSK-NS		
	TRA-NS	0.03556	Cu foil
	Laminate	0.254 ± 0.152	Rogers 4350B
	TRA-2	0.0178	Cu foil
	Laminate	0.889 nom.	FR4 Prepreg (Note 1)
	TRA-3	0.0178	Cu foil
	Laminate	0.254 ± 0.152	FR4 Core
	TRA-FS	0.0178	Cu foil
	MSK-PS		

Note 1: Adjust this thickness to meet total thickness goal.

General Notes:

Material: Rogers R04350,  $\epsilon_r = 3.66$   
 Layer 1 thickness: 0.254 mm  
 Overall board thickness: 1.575 mm  
 50  $\Omega$  transmission line width: 0.522 mm  
 Coplanar ground spacing: 0.394 mm  
 Via diameter: 0.254 mm

S2530

Figure 29. Layer Detail Physical Characteristics

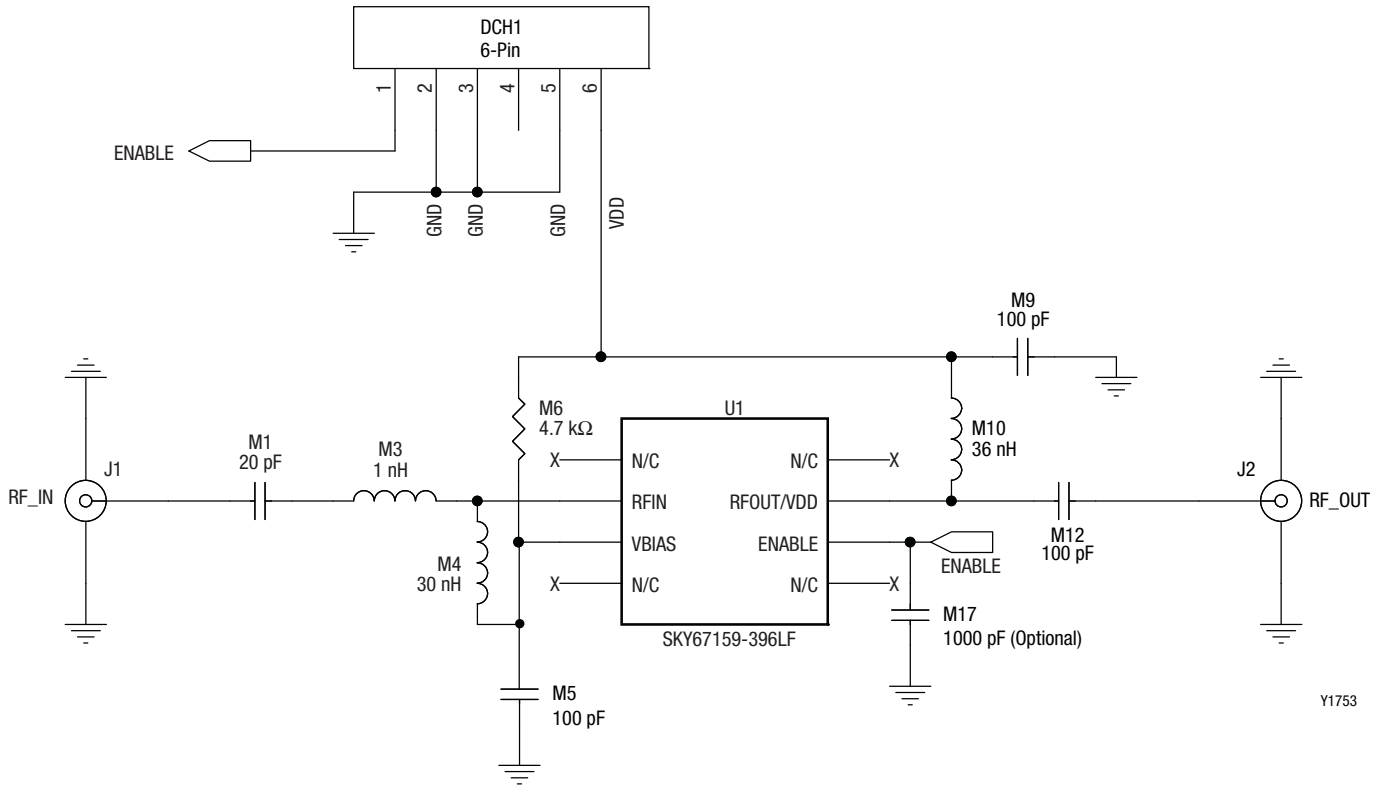

Figure 30. SKY67159-396LF Evaluation Board Schematic (Optimized for 700 to 2700 MHz)

Table 6. SKY67159-396LF Evaluation Board Bill of Materials (700 to 2700 MHz)

Component	Description	Value	Size	Manufacturer	Mfr Part Number
M1	Capacitor	20 pF	0402	Murata GJM	GJM1555C1H200JB01
M3	Inductor	1 nH	0402	Coilcraft HP	0402HP-1N0XJL
M4	Inductor	30 nH	0402	Coilcraft HP	0402HP-30NX_L_
M5, M9, M12	Capacitor	100 pF	0402	Murata GRM	GRM1555C1H101JA01D
M6 (RBIAS)	Resistor	4.7 kΩ	0402	Panasonic	ERJ-2RKF4701X
M10	Inductor	36 nH	0402	Coilcraft HP	0402HP-36NX_L_
M14, M16	Jumper	0 Ω	0402	Panasonic	ERJ-2GE0R00X
M2, M7, M8, M11, M13, M15, M17 <sup>1</sup>	DNP				

<sup>1</sup> M17 is optional. It is only needed if the control signal is noisy.

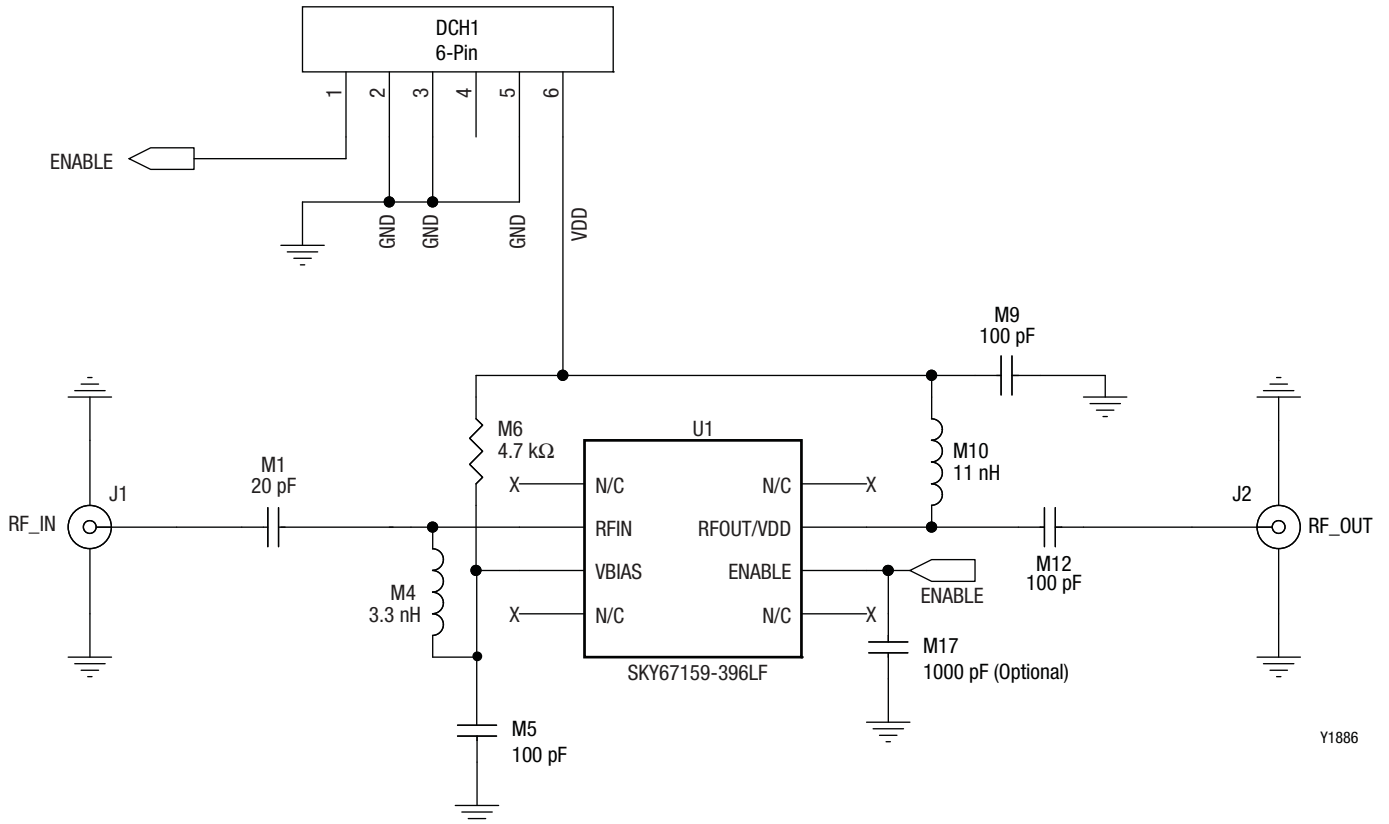
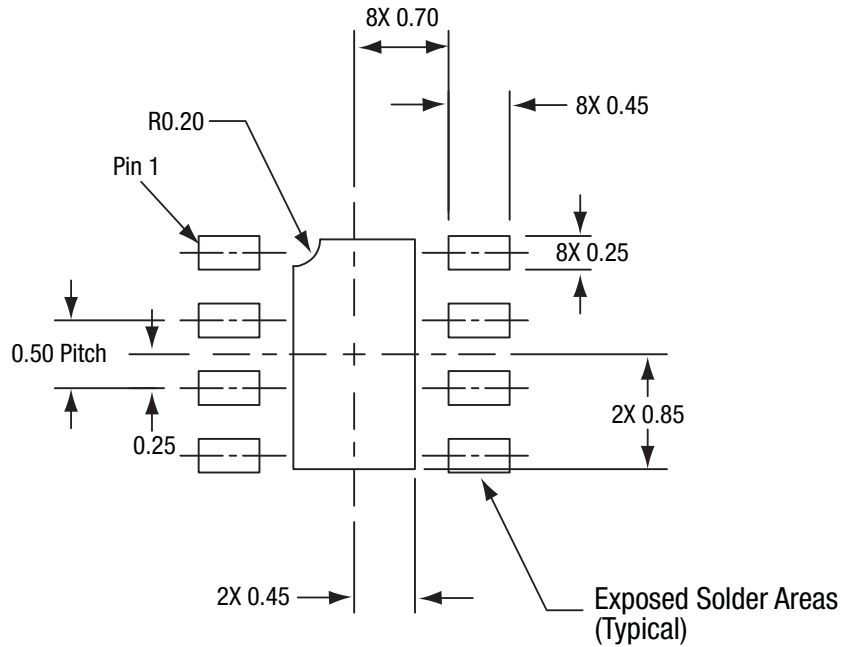

Figure 31. SKY67159-396LF Evaluation Board Schematic (Optimized for 3400 to 3800 MHz)

Table 7. SKY67159-396LF Evaluation Board Bill of Materials (3400 to 3800 MHz)

Component	Description	Value	Size	Manufacturer	Part Number
M1	Capacitor	20 pF	0402	Murata GJM	GJM1555C1H200JB01
M4	Inductor	3.3 nH	0402	Coilcraft HP	0402HP-3N3X_L_
M5, M9, M12	Capacitor	100 pF	0402	Murata GRM	GRM1555C1H101JA01D
M6 (RBIAS)	Resistor	4.7 kΩ	0402	Panasonic	ERJ-2RKF4701X
M10	Inductor	11 nH	0402	Coilcraft HP	0402HP-11NX_L_
M3, M14, M16	Jumper	0 Ω	0402	Panasonic	ERJ-2GE0R00X
M2, M7, M8, M11, M13, M15, M17 <sup>1</sup>	DNP				

<sup>1</sup> M17 is optional. It is only needed if the control signal is noisy.



All dimensions are in millimeters

S1413

**Figure 32. SKY67159-396LF PCB Layout Footprint (Top View)**

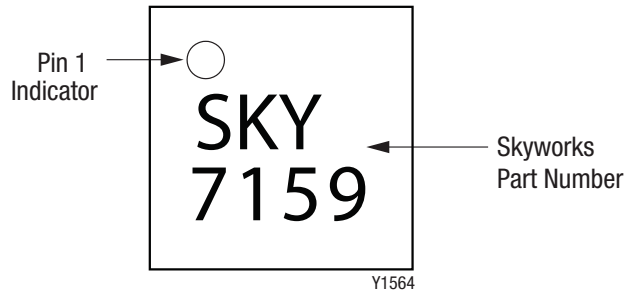

**Figure 33. Typical Part Markings (Top View)**

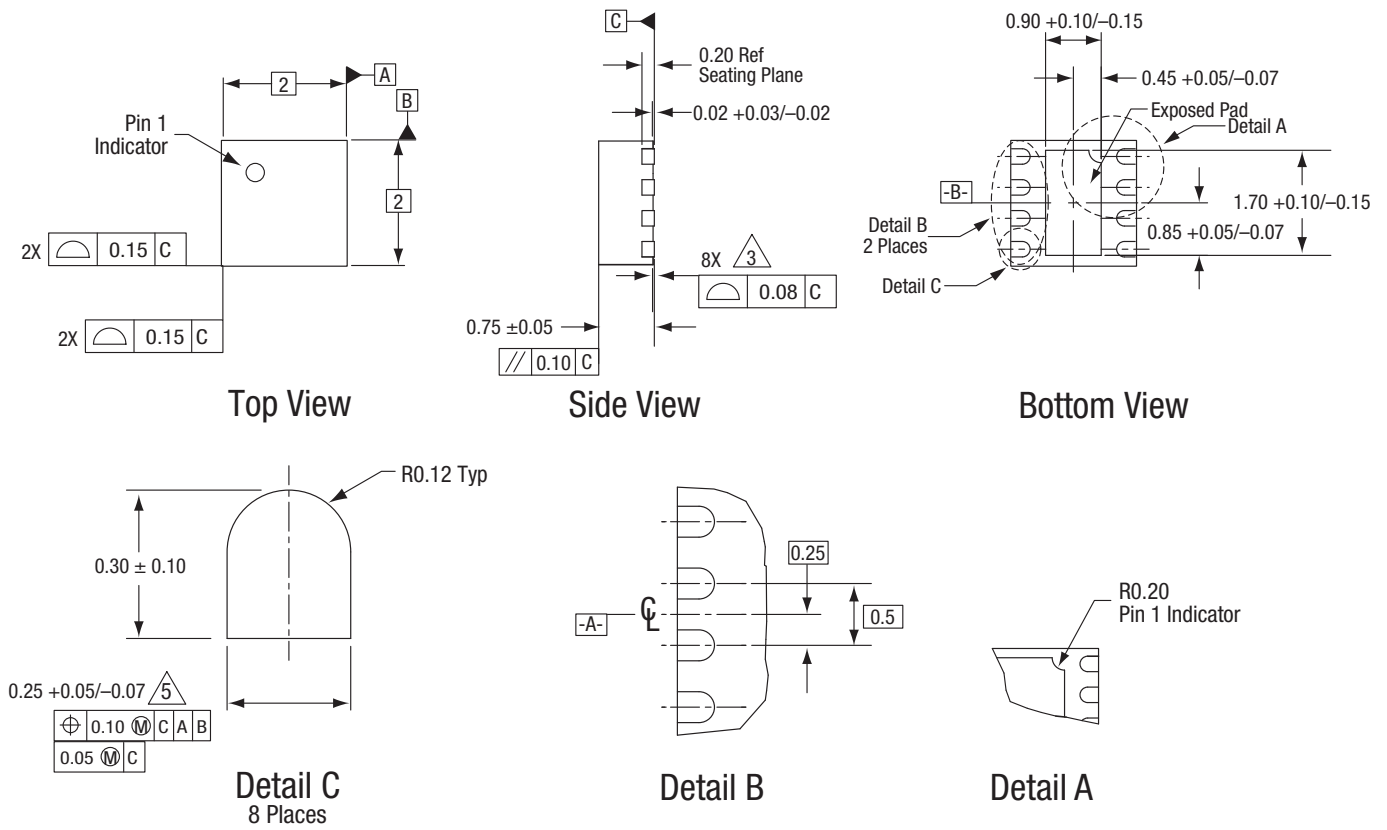

Notes:

1. All measurements are in millimeters.
2. Dimensions and tolerances according to ASME Y14.5M-1994.
3. Coplanarity applies to the exposed heat sink ground pad as well as the terminals.
4. Plating requirement per source control drawing (SCD) 2504.
5. Dimension applies to metallized terminal and is measured between 0.15 mm and 0.30 mm from terminal tip.

S1945

Figure 34. SKY67159-396LF Package Dimensions



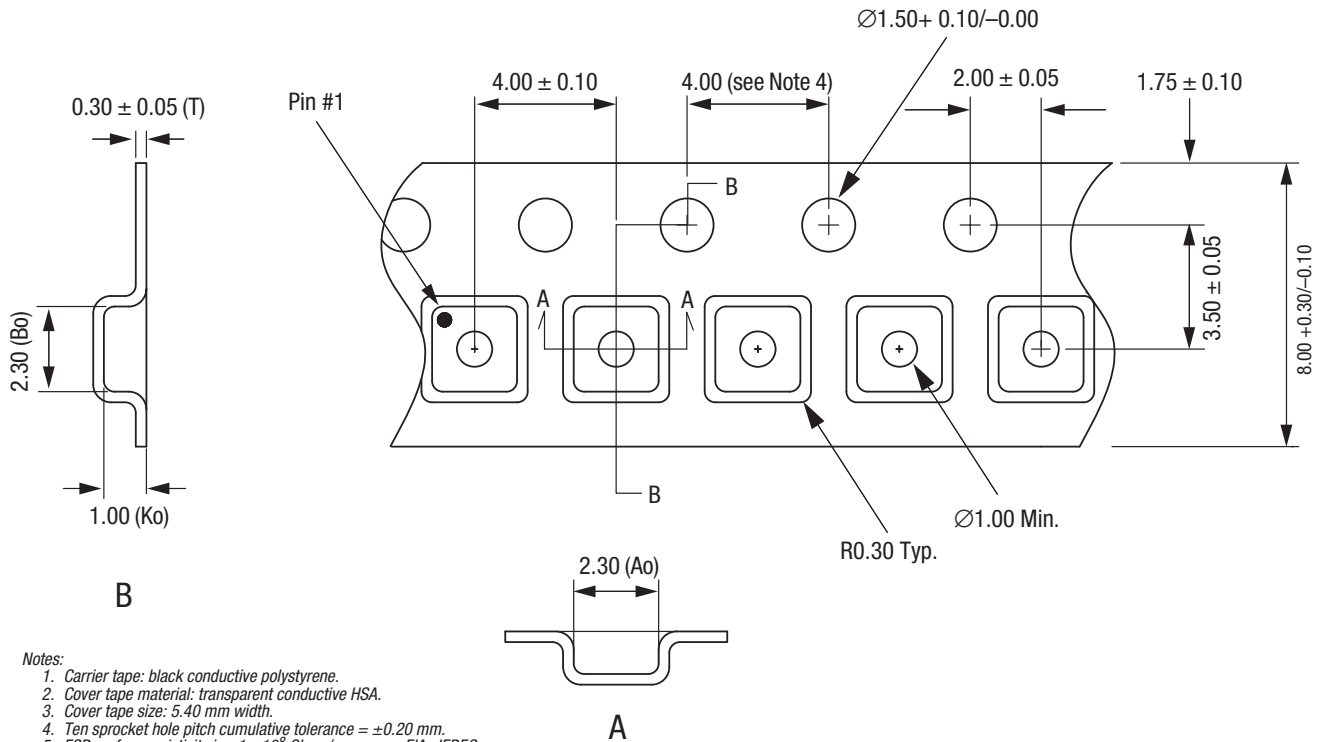

Notes:

1. Carrier tape: black conductive polystyrene.
2. Cover tape material: transparent conductive HSA.
3. Cover tape size: 5.40 mm width.
4. Ten sprocket hole pitch cumulative tolerance =  $\pm 0.20$  mm.
5. ESD surface resistivity is  $\leq 1 \times 10^8$  Ohms/square per EIA, JEDEC tape and reel specification.
6. Ao and Bo measurement point to be 0.30 mm from bottom pocket.
7. All measurements are in millimeters.

S1601

Figure 35. SKY67159-396LF Tape and Reel Dimensions