

**Description: ON-VEHICLE LOW PROFILE ANTENNA**

**Series: Shadow**

**PART NUMBER: Black: SLPTXXX / White: SLPTXXXW**



**Features:**

- SLPT in Black and White
- Short, slim profile without sacrificing RF or mechanical performance
- Direct and NMO mount models
- IP67 Weatherproof

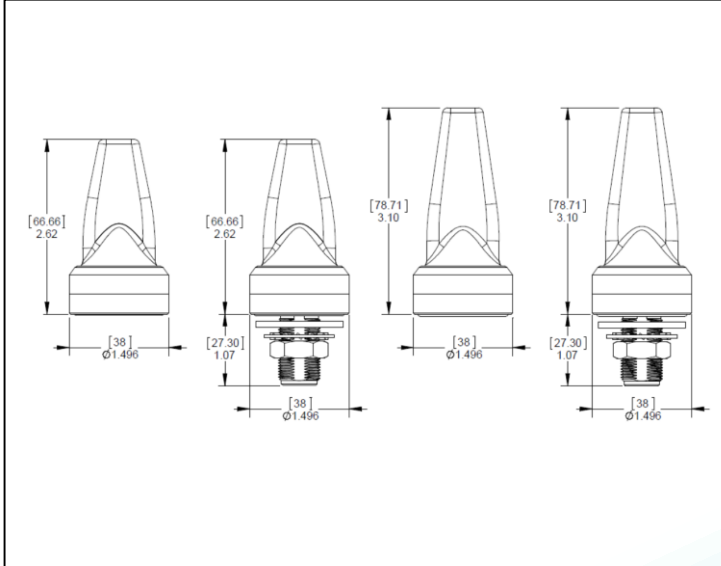

All dimensions are in mm / inches

**Applications:**

- Models supporting :
  - Public Safety, LMR
  - Wi-Fi,
  - 3G/4G LTE,
  - ISM
  - DSRC
- Bus/Rail/Transit
- IoT – Vending, metering and other industrial applications
- Outdoor Vehicular

Issue: 1829

In the effort to improve our products, we reserve the right to make changes judged to be necessary.

CONFIDENTIAL AND PROPRIETARY INFORMATION

This document contains confidential and proprietary information of Pulse Electronics, Inc. (Pulse) and is protected by copyright, trade secret and other state and federal laws. Its receipt or possession does not convey any rights to reproduce, disclose its contents, or to manufacture, use or sell anything it may describe. Reproduction, disclosure or use without specific written authorization of Pulse is strictly forbidden.

For more information:

Pulse Worldwide Headquarters  
15255 Innovation Drive #100  
San Diego, CA 92128  
USA  
Tel:1-858-674-8100

Pulse/Larsen Antennas  
18110 SE 34<sup>th</sup> St Bldg 2 Suite 250  
Vancouver, WA 98683  
USA  
Tel: 1-360-944-7551

Europe Headquarters  
Pulse GmbH & Do, KG  
Zeppelinstrasse 15  
Herrenberg, Germany  
Tel: 49 7032 7806 0

Pulse (Suzhou) Wireless Products Co, Inc.  
99 Huo Ju Road(#29 Bldg,4<sup>th</sup> Phase  
Suzhou New District  
Jiangsu Province, Suzhou 215009 PR China  
Tel: 86 512 6807 9998



Description: ON-VEHICLE LOW PROFILE ANTENNA

Series: Shadow

PART NUMBER: Black: SLPTXXX / White: SLPTXXXW

This document covers all product variants of the following product family:

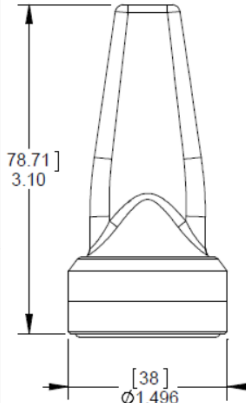
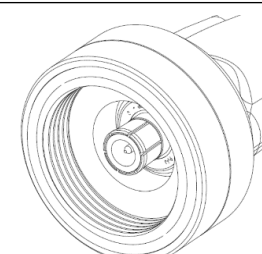
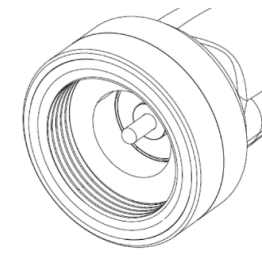
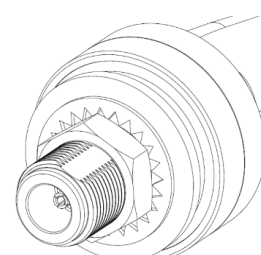
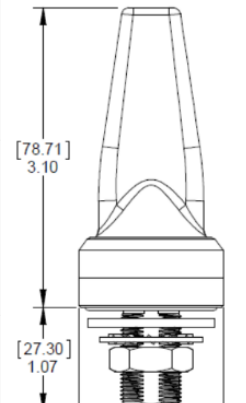
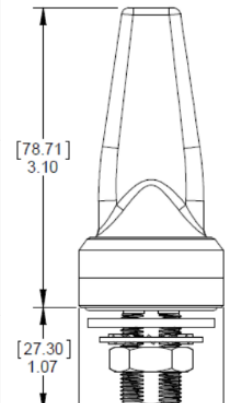
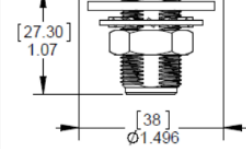
Project	Color	Frequency	Size	Fixing System Connector	
SLPT698/2170NMOHFW	White	698-960MHz 1710-2700MHz		 NMOHF NMO + HF Connector	
SLPT698/2170NMOHF	Black				
SLPT698/960NMOW	White	698-960MHz		 NMO + Pogo Pin Connector	
SLPT698/960NMO	Black				
SLPT806NMOW	White	806-960MHz			 Direct Mount N Female Connector (Screw 5/8-24 UNEF 2A)
SLPT806NMO	Black				
SLPT698/869DMNW	White	698-869MHz			
SLPT698/869DMN	Black				
SLPT806DMNW	White	806-960MHz			
SLPT806DMN	Black				
SLPT698/2170DMNW	White	698-960MHz 1710-2700MHz			
SLPT698/2170DMN	Black				

Description: ON-VEHICLE LOW PROFILE ANTENNA

Series: Shadow

PART NUMBER: Black: SLPTXXX / White: SLPTXXXW

This document covers all product variants of the following product family:

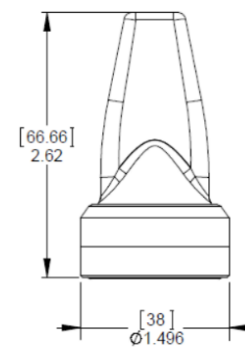
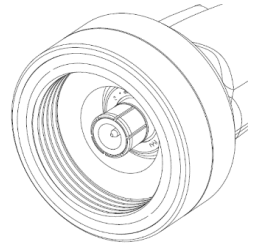
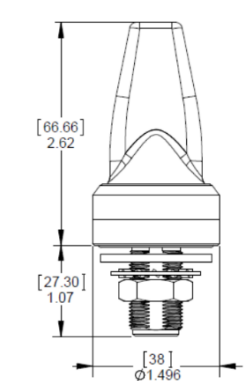
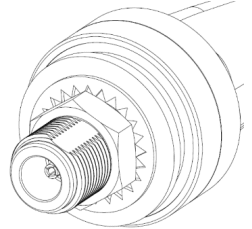
Project	Color	Frequency	Size	Fixing System Connector	
SLPT2400NMOHFW	White	2400-2500MHz		 NMOHF NMO + HF Connector	
SLPT2400NMOHF	Black				
SLPT4900NMOHFW	White	4900-6000MHz			
SLPT4900NMOHF	Black				
SLPT245NMOHFW	White	2400-2500MHz 4900-6000MHz			 Direct Mount N Female Connector (Screw 5/8-24 UNEF 2A)
SLPT2400/5900NMOHF	Black				
SLPT2400DMNW	White	2400-2500MHz			
SLPT2400DMN	Black				
SLPT4900DMNW	White	4900-6000MHz			
SLPT4900DMN	Black				
SLPT2400/5900DMNW	White	2400-2500MHz 4900-6000MHz			
SLPT2400/5900DMN	Black				

P.S.: For DMN fixing system, it requires a 5/8" (16mm) hole in the mounting surface.

Remove any burrs, particularly on the Roof under side of the hole. Remove paint in a narrow ring around the hole. Metal-to-metal contact between the mounting surface and mount is essential for best performance.

Description: ON-VEHICLE LOW PROFILE ANTENNA

Series: Shadow

PART NUMBER: Black: SLPTXXX / White: SLPTXXXW

**ELECTRICAL SPECIFICATIONS**

Project	Frequency	VSWR	Peak Gain	Efficiency	Power Handling
SLPT698/2170NMOHFW	698-960MHz 1710-2700MHz	3.3:1(0.698-0.96GHz) 2:1(1.71-2.5GHz) 2.2:1(2.5-2.7GHz)	3.52dBi(0.698-0.96GHz) 4.95dBi(1.71-2.69GHz)	72% 71%	40W(100% duty cycle)  50W(50% duty cycle)
SLPT698/2170NMOHF					
SLPT698/960NMOW	698-960MHz	2:1	3.29dBi	68%	35W(100% duty cycle) 40W(50% duty cycle)
SLPT698/960NMO					
SLPT806NMOW	806-960MHz	2:1	3.18dBi	67%	35W(100% duty cycle) 40W(50% duty cycle)
SLPT806NMO					
SLPT698/869DMNW	698-869MHz	2:1	3.26dBi	72%	30W(100% duty cycle) 40W(50% duty cycle)
SLPT698/869DMN					
SLPT806DMNW	806-960MHz	2:1	3.05dBi	70%	40W(100% duty cycle) 45W(50% duty cycle)
SLPT806DMN					
SLPT698/2170DMNW	698-960MHz 1710-2700MHz	3.3:1(0.698-0.96GHz) 2:1(1.71-2.5GHz) 2.2:1(2.5-2.7GHz)	3.51dBi(0.698-0.96GHz) 4.81dBi(1.71-2.69GHz)	76% 67%	40W(100% duty cycle)  50W(50% duty cycle)
SLPT698/2170DMN					

Issue: 1829

In the effort to improve our products, we reserve the right to make changes judged to be necessary.

CONFIDENTIAL AND PROPRIETARY INFORMATION

This document contains confidential and proprietary information of Pulse Electronics, Inc. (Pulse) and is protected by copyright, trade secret and other state and federal laws. Its receipt or possession does not convey any rights to reproduce, disclose its contents, or to manufacture, use or sell anything it may describe. Reproduction, disclosure or use without specific written authorization of Pulse is strictly forbidden.

Description: ON-VEHICLE LOW PROFILE ANTENNA

Series: Shadow

PART NUMBER: Black: SLPTXXX / White: SLPTXXXW

**ELECTRICAL SPECIFICATIONS**

Project	Frequency	VSWR	Peak Gain	Efficiency	Power Handling
SLPT2400NMOHFW	2400-2500MHz	2:1	5.06dBi	79%	35W(100% duty cycle)
SLPT2400NMOHF					45W(50% duty cycle)
SLPT4900NMOHFW	4900-6000MHz	2.2:1	5.09dBi	71%	35W(100% duty cycle)
SLPT4900NMOHF					45W(50% duty cycle)
SLPT245NMOHFW	2400-2500MHz 4900-6000MHz	2:1(2.4-2.5GHz) 2.2:1(4.9-6GHz)	5.06dBi 5.09dBi	79% 71%	35W(100% duty cycle)
SLPT2400/5900NMOHF					45W(50% duty cycle)
SLPT2400DMNW	2400-2500MHz	2:1	4.78dBi	75%	35W(100% duty cycle)
SLPT2400DMN					45W(50% duty cycle)
SLPT4900DMNW	4900-6000MHz	2.2:1	5.14dBi	73%	35W(100% duty cycle)
SLPT4900DMN					45W(50% duty cycle)
SLPT2400/5900DMNW	2400-2500MHz 4900-6000MHz	2:1(2.4-2.5GHz) 2.2:1(4.9-6GHz)	4.78dBi 5.14dBi	79% 73%	35W(100% duty cycle)
SLPT2400/5900DMN					45W(50% duty cycle)

Nominal Impedance

50Ω

Radiation Pattern

omni

Polarization:

Vertical

Issue: 1829

In the effort to improve our products, we reserve the right to make changes judged to be necessary.

CONFIDENTIAL AND PROPRIETARY INFORMATION

This document contains confidential and proprietary information of Pulse Electronics, Inc. (Pulse) and is protected by copyright, trade secret and other state and federal laws. Its receipt or possession does not convey any rights to reproduce, disclose its contents, or to manufacture, use or sell anything it may describe. Reproduction, disclosure or use without specific written authorization of Pulse is strictly forbidden.

**Description: ON-VEHICLE LOW PROFILE ANTENNA****Series: Shadow****PART NUMBER: Black: SLPTXXX / White: SLPTXXXW****MECHANICAL SPECIFICATIONS**

Plastic radome	PC
Color	White / Black
Ingress Protection	IP67

**ENVIRONMENTAL SPECIFICATIONS**

Operating temperature	-40 ~ +85° C
-----------------------	--------------

Issue: 1829

In the effort to improve our products, we reserve the right to make changes judged to be necessary.

CONFIDENTIAL AND PROPRIETARY INFORMATION

This document contains confidential and proprietary information of Pulse Electronics, Inc. (Pulse) and is protected by copyright, trade secret and other state and federal laws. Its receipt or possession does not convey any rights to reproduce, disclose its contents, or to manufacture, use or sell anything it may describe. Reproduction, disclosure or use without specific written authorization of Pulse is strictly forbidden.

Description: ON-VEHICLE LOW PROFILE ANTENNA

Series: Shadow

PART NUMBER: Black: SLPTXXX / White: SLPTXXXW

CHARTS

VSWR

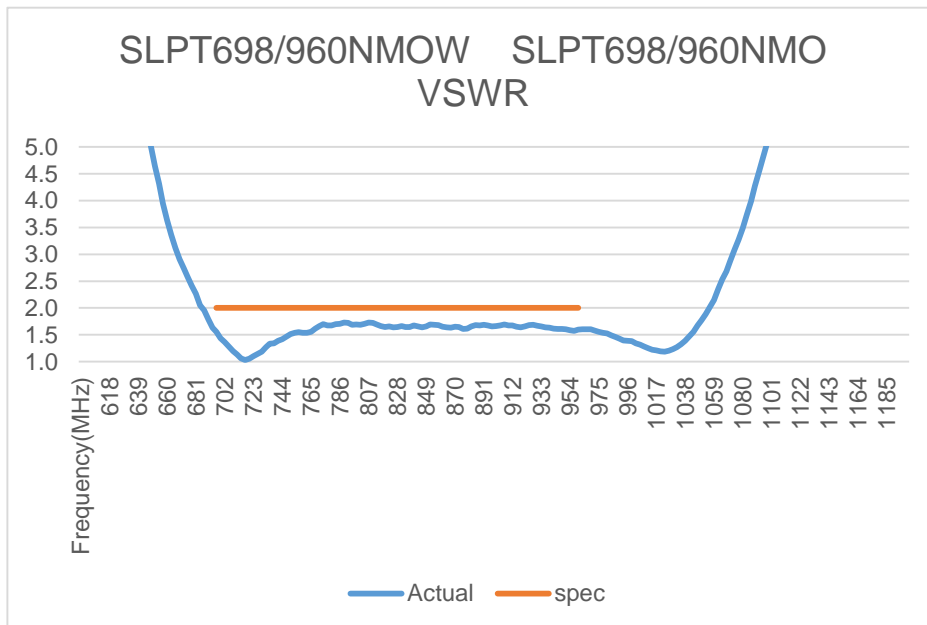
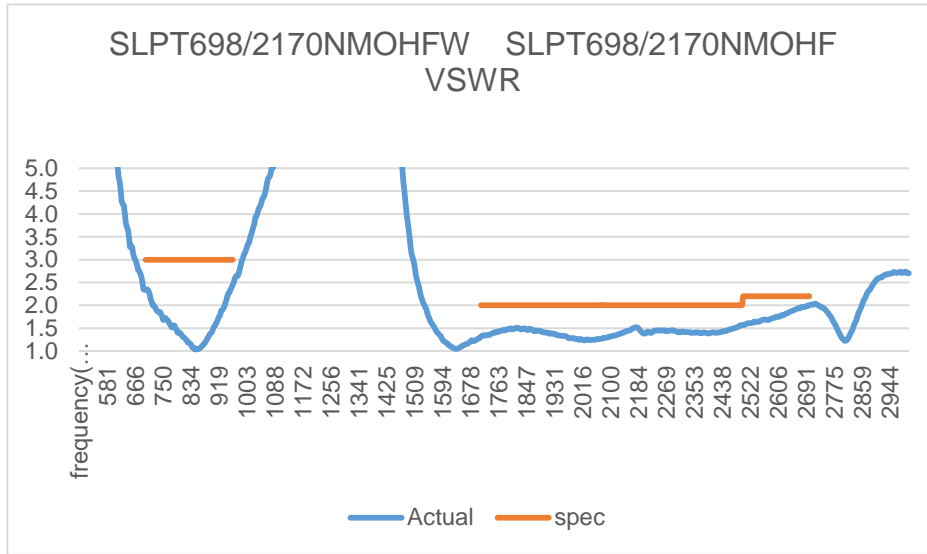

Issue: 1829

In the effort to improve our products, we reserve the right to make changes judged to be necessary.

CONFIDENTIAL AND PROPRIETARY INFORMATION

This document contains confidential and proprietary information of Pulse Electronics, Inc. (Pulse) and is protected by copyright, trade secret and other state and federal laws. Its receipt or possession does not convey any rights to reproduce, disclose its contents, or to manufacture, use or sell anything it may describe. Reproduction, disclosure or use without specific written authorization of Pulse is strictly forbidden.

Description: ON-VEHICLE LOW PROFILE ANTENNA

Series: Shadow

PART NUMBER: Black: SLPTXXX / White: SLPTXXXW

CHARTS

VSWR

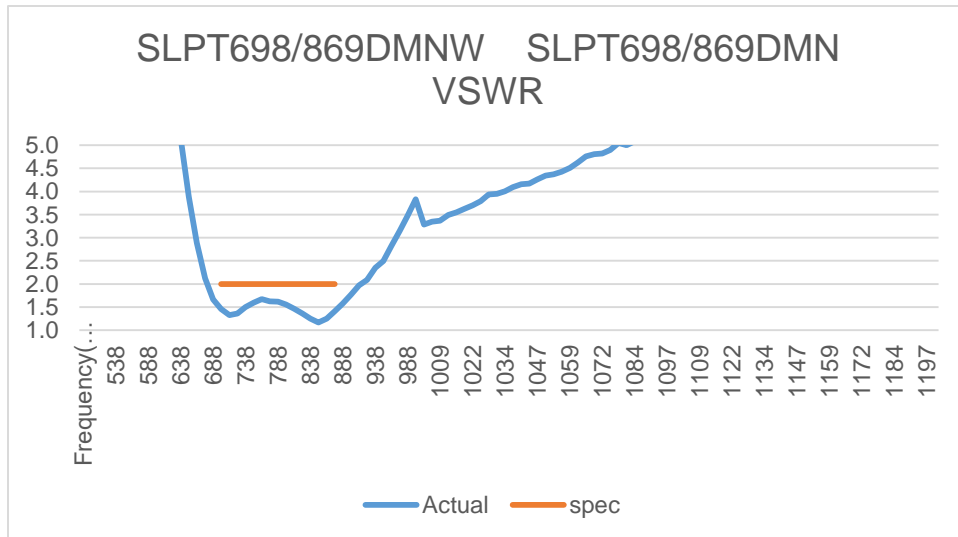
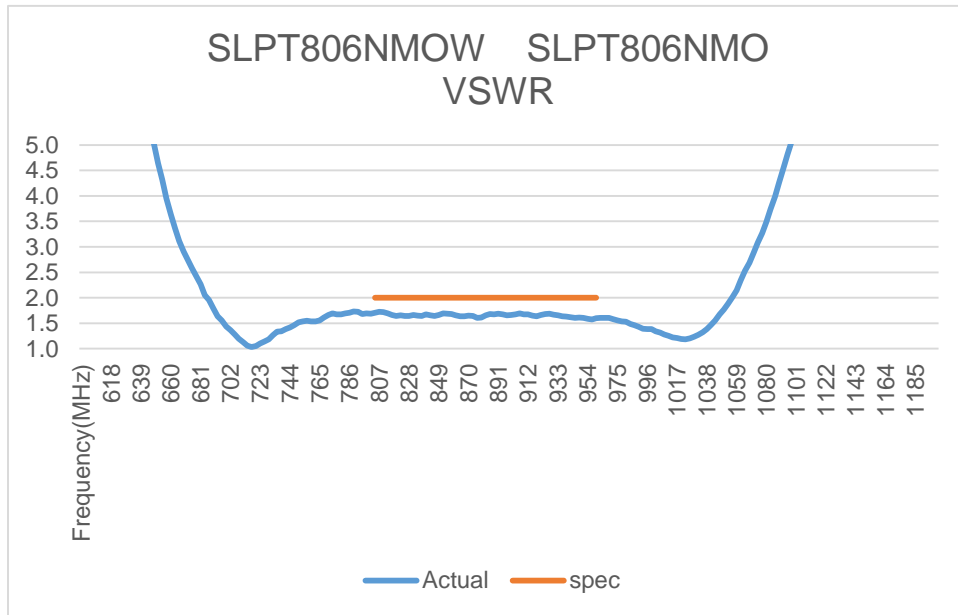

Issue: 1829

In the effort to improve our products, we reserve the right to make changes judged to be necessary.

CONFIDENTIAL AND PROPRIETARY INFORMATION

This document contains confidential and proprietary information of Pulse Electronics, Inc. (Pulse) and is protected by copyright, trade secret and other state and federal laws. Its receipt or possession does not convey any rights to reproduce, disclose its contents, or to manufacture, use or sell anything it may describe. Reproduction, disclosure or use without specific written authorization of Pulse is strictly forbidden.



Description: ON-VEHICLE LOW PROFILE ANTENNA

Series: Shadow

PART NUMBER: Black: SLPTXXX / White: SLPTXXXW

CHARTS

VSWR

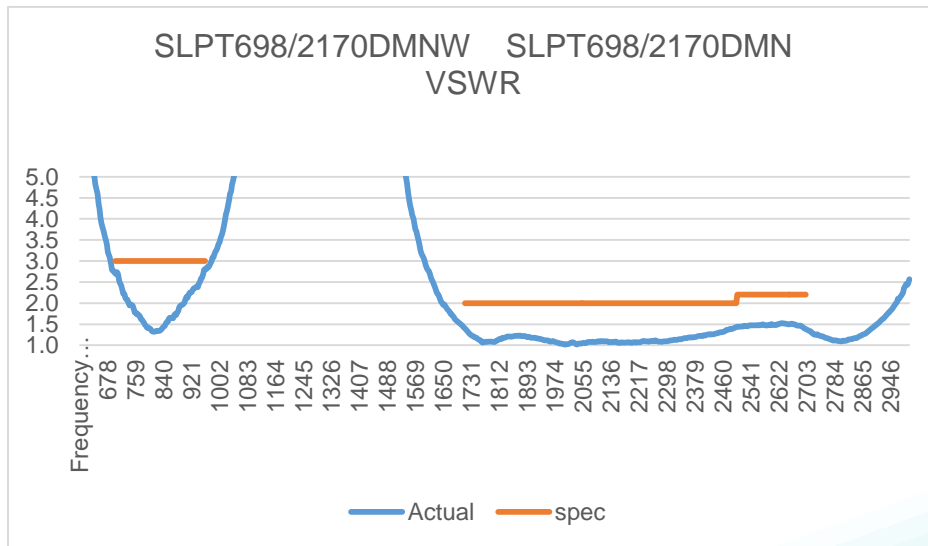
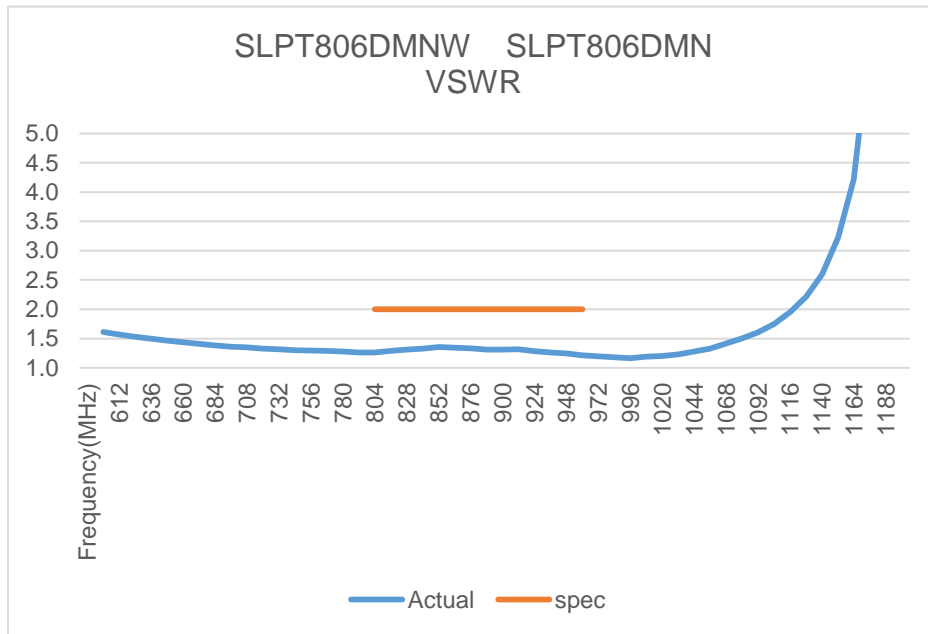

Issue: 1829

In the effort to improve our products, we reserve the right to make changes judged to be necessary.

CONFIDENTIAL AND PROPRIETARY INFORMATION

This document contains confidential and proprietary information of Pulse Electronics, Inc. (Pulse) and is protected by copyright, trade secret and other state and federal laws. Its receipt or possession does not convey any rights to reproduce, disclose its contents, or to manufacture, use or sell anything it may describe. Reproduction, disclosure or use without specific written authorization of Pulse is strictly forbidden.

Description: ON-VEHICLE LOW PROFILE ANTENNA

Series: Shadow

PART NUMBER: Black: SLPTXXX / White: SLPTXXXW

CHARTS

VSWR

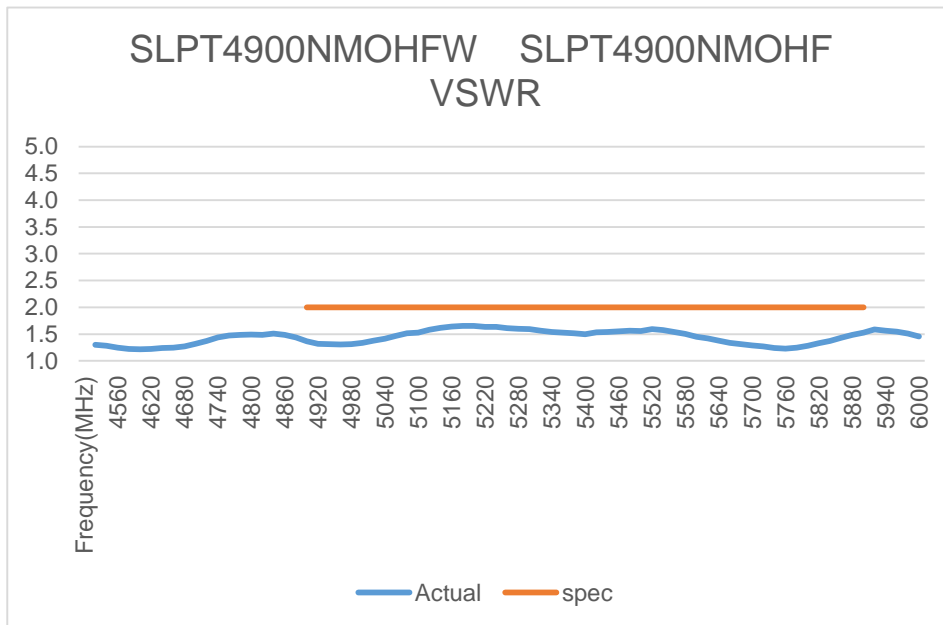
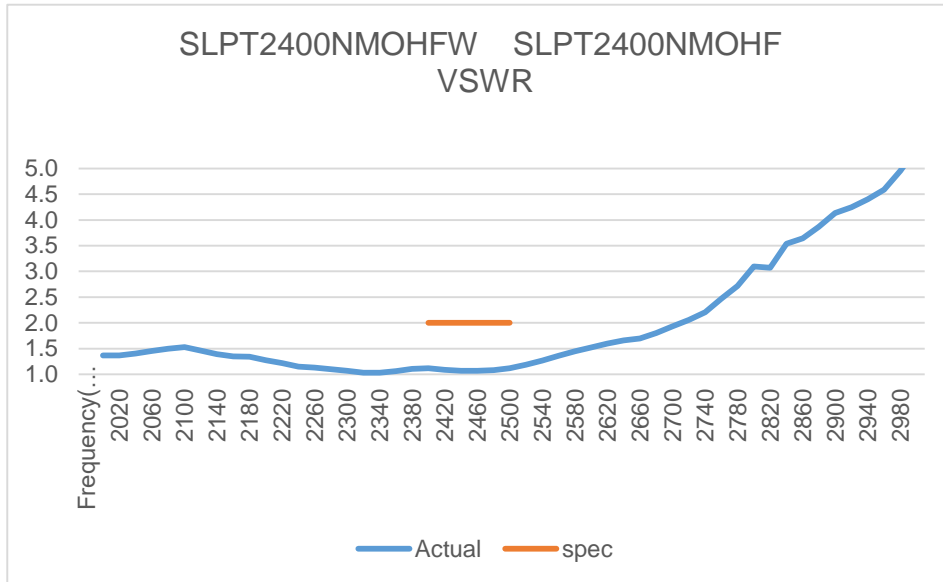

Issue: 1829

In the effort to improve our products, we reserve the right to make changes judged to be necessary.

CONFIDENTIAL AND PROPRIETARY INFORMATION

This document contains confidential and proprietary information of Pulse Electronics, Inc. (Pulse) and is protected by copyright, trade secret and other state and federal laws. Its receipt or possession does not convey any rights to reproduce, disclose its contents, or to manufacture, use or sell anything it may describe. Reproduction, disclosure or use without specific written authorization of Pulse is strictly forbidden.

Description: ON-VEHICLE LOW PROFILE ANTENNA

Series: Shadow

PART NUMBER: Black: SLPTXXX / White: SLPTXXXW

CHARTS

VSWR

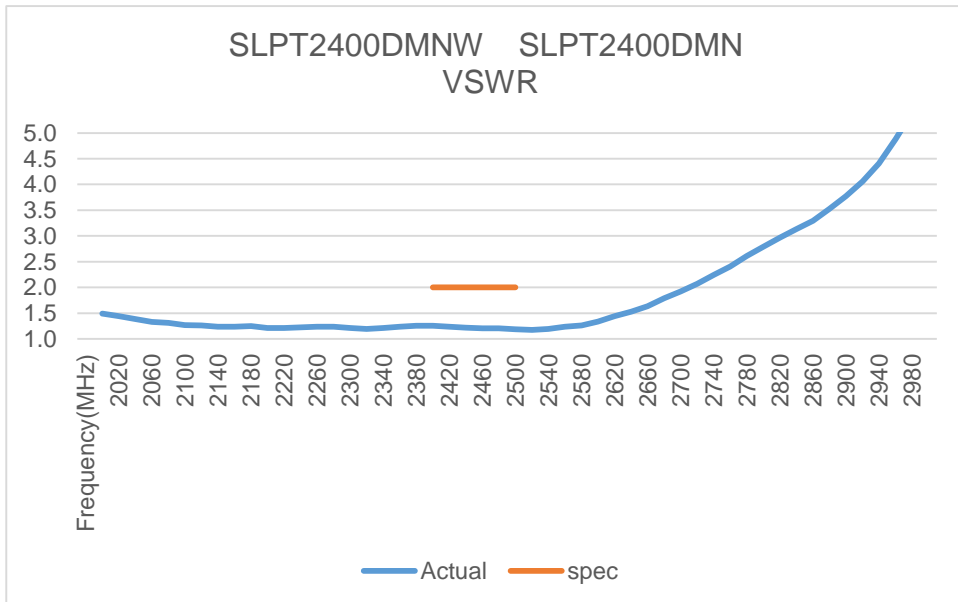
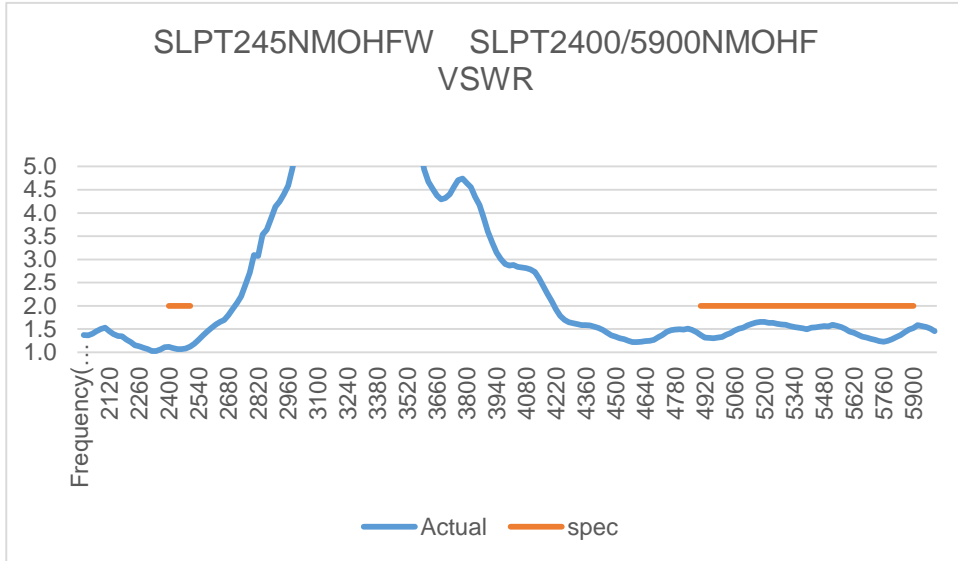

Issue: 1829

In the effort to improve our products, we reserve the right to make changes judged to be necessary.

CONFIDENTIAL AND PROPRIETARY INFORMATION

This document contains confidential and proprietary information of Pulse Electronics, Inc. (Pulse) and is protected by copyright, trade secret and other state and federal laws. Its receipt or possession does not convey any rights to reproduce, disclose its contents, or to manufacture, use or sell anything it may describe. Reproduction, disclosure or use without specific written authorization of Pulse is strictly forbidden.

Description: ON-VEHICLE LOW PROFILE ANTENNA

Series: Shadow

PART NUMBER: Black: SLPTXXX / White: SLPTXXXW

CHARTS

VSWR

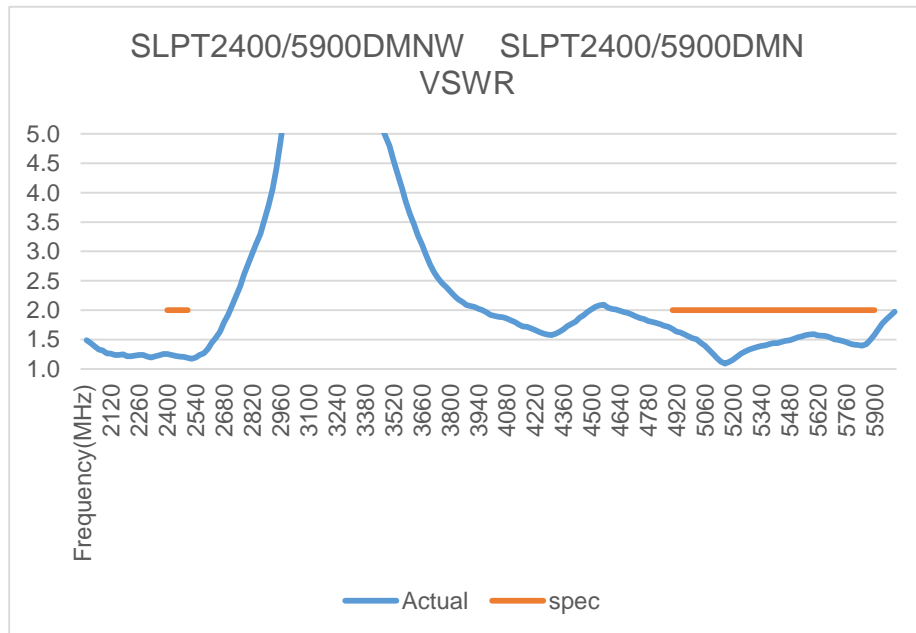
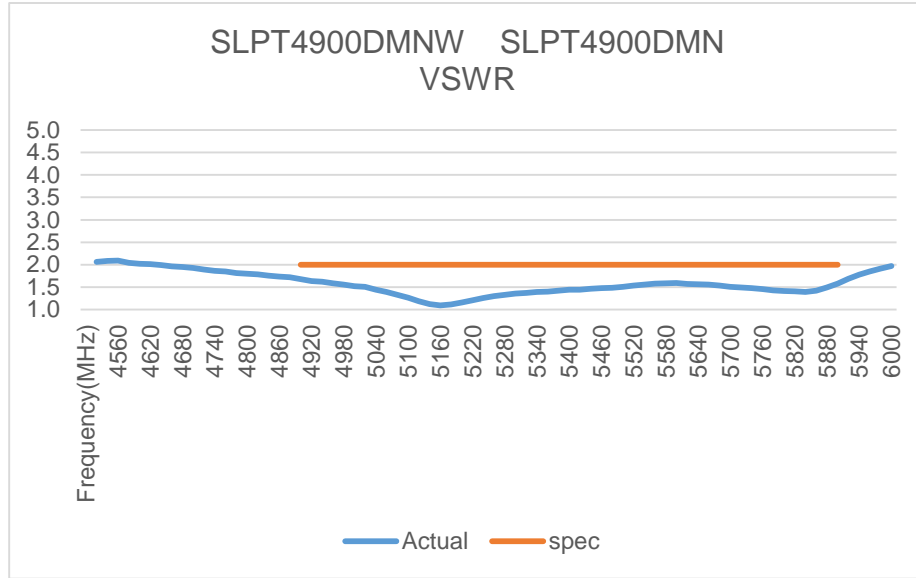

Issue: 1829

In the effort to improve our products, we reserve the right to make changes judged to be necessary.

CONFIDENTIAL AND PROPRIETARY INFORMATION

This document contains confidential and proprietary information of Pulse Electronics, Inc. (Pulse) and is protected by copyright, trade secret and other state and federal laws. Its receipt or possession does not convey any rights to reproduce, disclose its contents, or to manufacture, use or sell anything it may describe. Reproduction, disclosure or use without specific written authorization of Pulse is strictly forbidden.

Description: ON-VEHICLE LOW PROFILE ANTENNA

Series: Shadow

PART NUMBER: Black: SLPTXXX / White: SLPTXXXW

CHARTS

Efficiency(%)

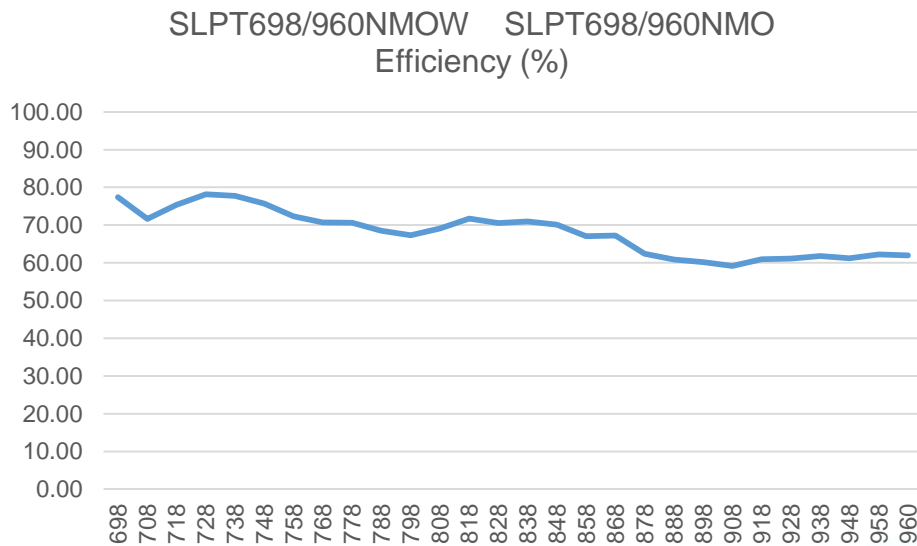
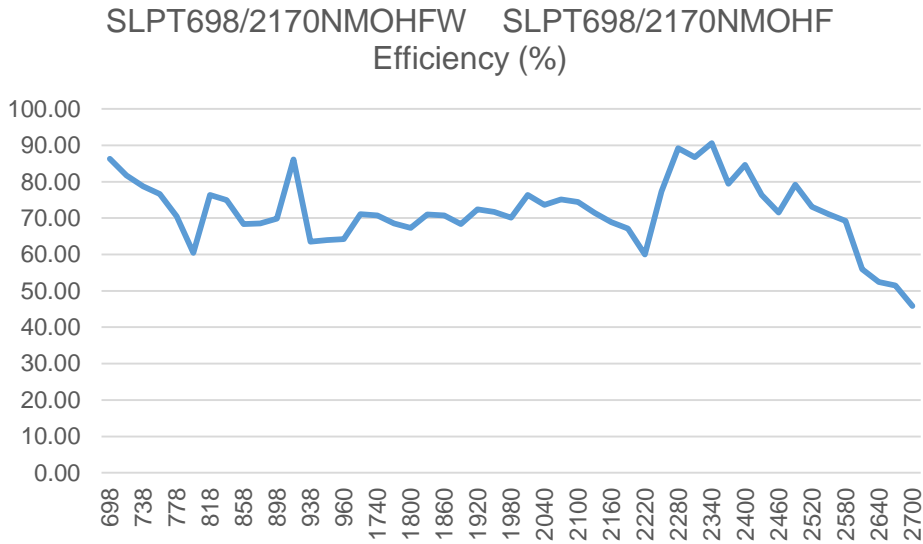

Issue: 1829

In the effort to improve our products, we reserve the right to make changes judged to be necessary.

CONFIDENTIAL AND PROPRIETARY INFORMATION

This document contains confidential and proprietary information of Pulse Electronics, Inc. (Pulse) and is protected by copyright, trade secret and other state and federal laws. Its receipt or possession does not convey any rights to reproduce, disclose its contents, or to manufacture, use or sell anything it may describe. Reproduction, disclosure or use without specific written authorization of Pulse is strictly forbidden.

Description: ON-VEHICLE LOW PROFILE ANTENNA

Series: Shadow

PART NUMBER: Black: SLPTXXX / White: SLPTXXXW

**CHARTS**

Efficiency(%)

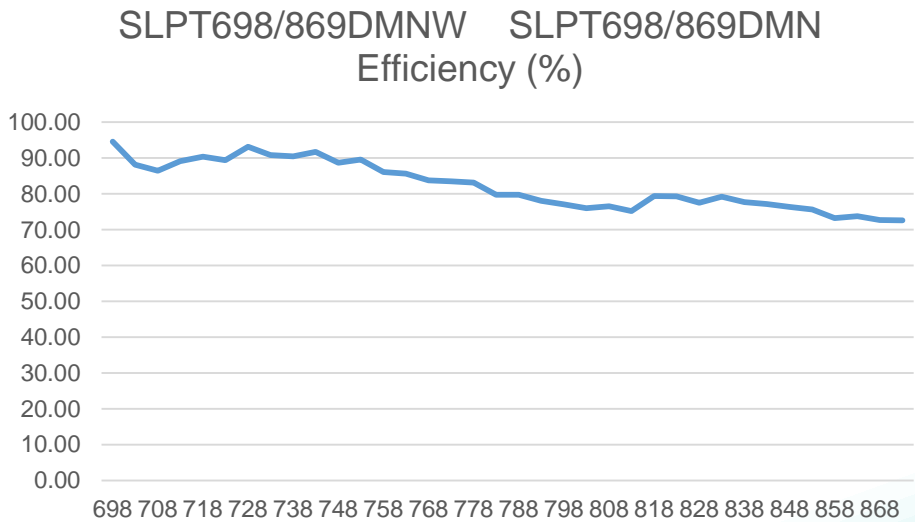
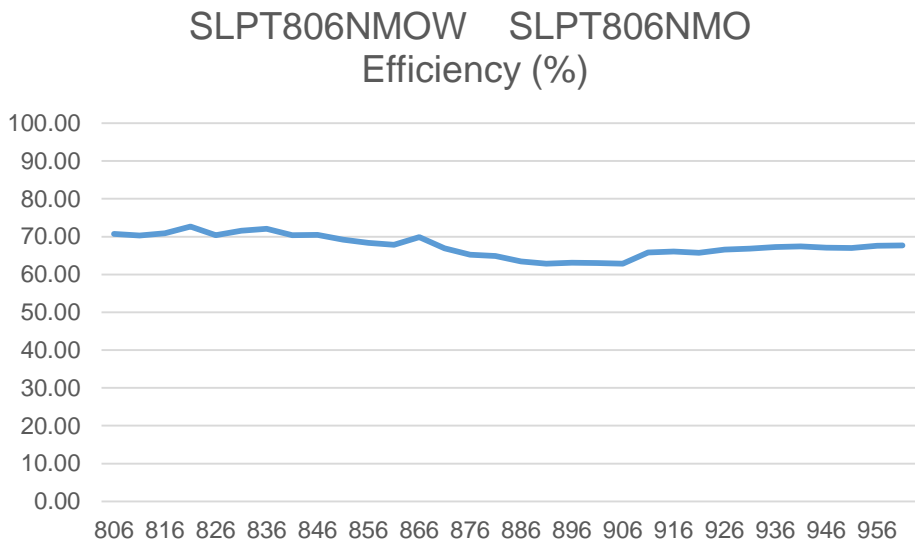

Issue: 1829

In the effort to improve our products, we reserve the right to make changes judged to be necessary.

CONFIDENTIAL AND PROPRIETARY INFORMATION

This document contains confidential and proprietary information of Pulse Electronics, Inc. (Pulse) and is protected by copyright, trade secret and other state and federal laws. Its receipt or possession does not convey any rights to reproduce, disclose its contents, or to manufacture, use or sell anything it may describe. Reproduction, disclosure or use without specific written authorization of Pulse is strictly forbidden.



Description: ON-VEHICLE LOW PROFILE ANTENNA

Series: Shadow

PART NUMBER: Black: SLPTXXX / White: SLPTXXXW

CHARTS

Efficiency(%)

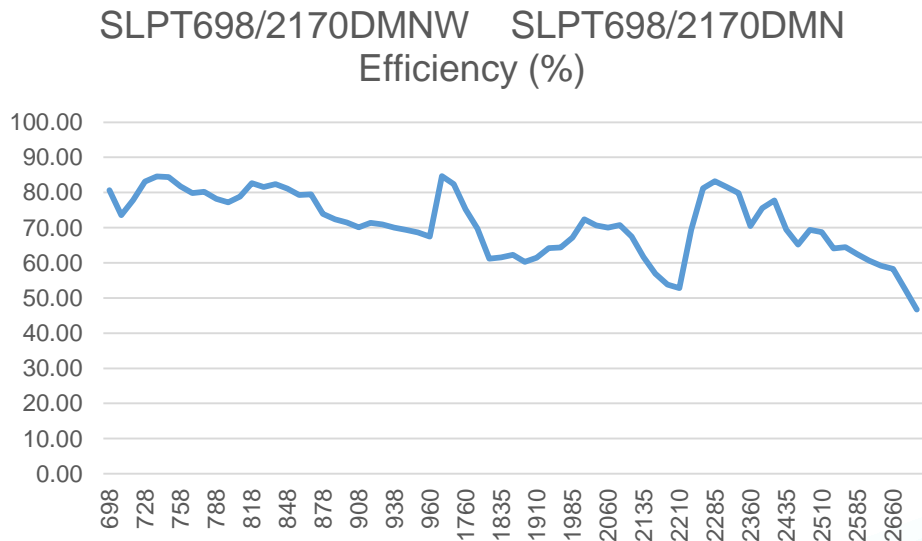
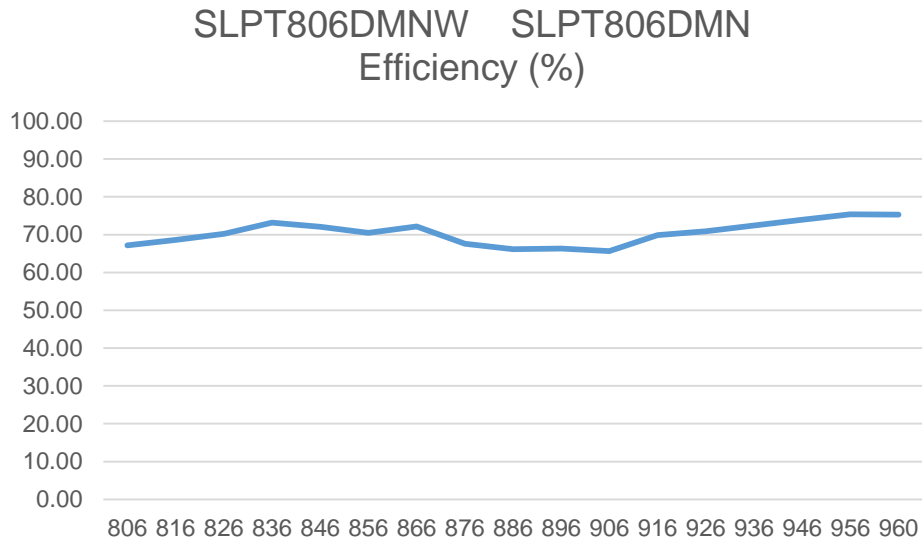

Issue: 1829

In the effort to improve our products, we reserve the right to make changes judged to be necessary.

CONFIDENTIAL AND PROPRIETARY INFORMATION

This document contains confidential and proprietary information of Pulse Electronics, Inc. (Pulse) and is protected by copyright, trade secret and other state and federal laws. Its receipt or possession does not convey any rights to reproduce, disclose its contents, or to manufacture, use or sell anything it may describe. Reproduction, disclosure or use without specific written authorization of Pulse is strictly forbidden.



Description: ON-VEHICLE LOW PROFILE ANTENNA

Series: Shadow

PART NUMBER: Black: SLPTXXX / White: SLPTXXXW

CHARTS

Efficiency(%)

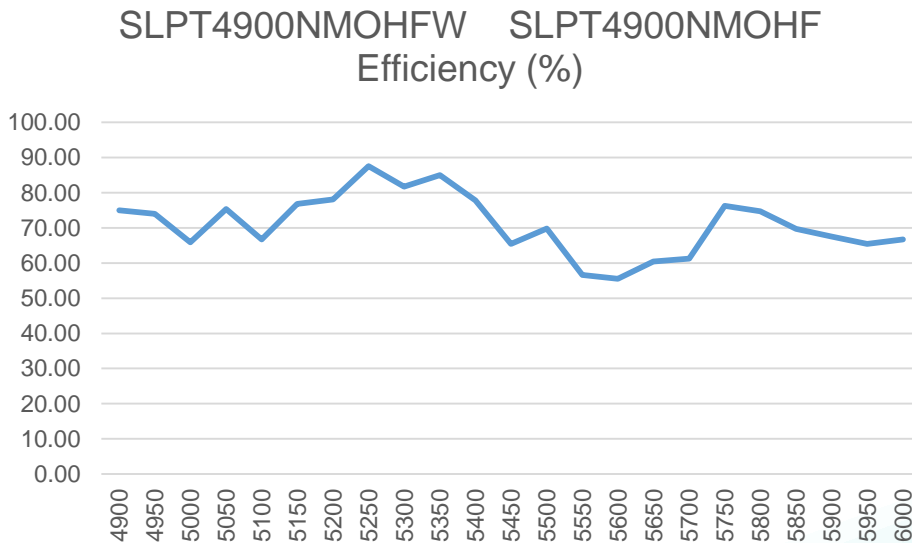
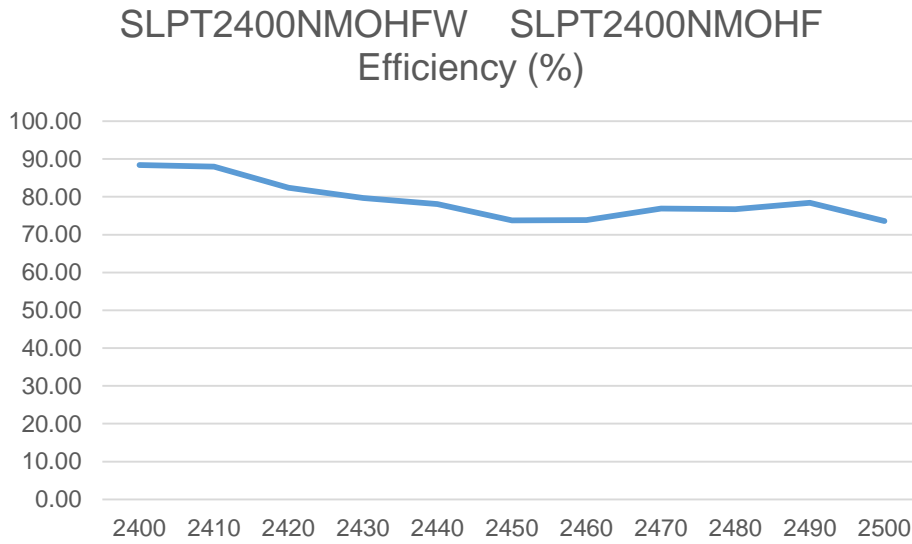

Issue: 1829

In the effort to improve our products, we reserve the right to make changes judged to be necessary.

CONFIDENTIAL AND PROPRIETARY INFORMATION

This document contains confidential and proprietary information of Pulse Electronics, Inc. (Pulse) and is protected by copyright, trade secret and other state and federal laws. Its receipt or possession does not convey any rights to reproduce, disclose its contents, or to manufacture, use or sell anything it may describe. Reproduction, disclosure or use without specific written authorization of Pulse is strictly forbidden.



Description: ON-VEHICLE LOW PROFILE ANTENNA

Series: Shadow

PART NUMBER: Black: SLPTXXX / White: SLPTXXXW

CHARTS

Efficiency(%)

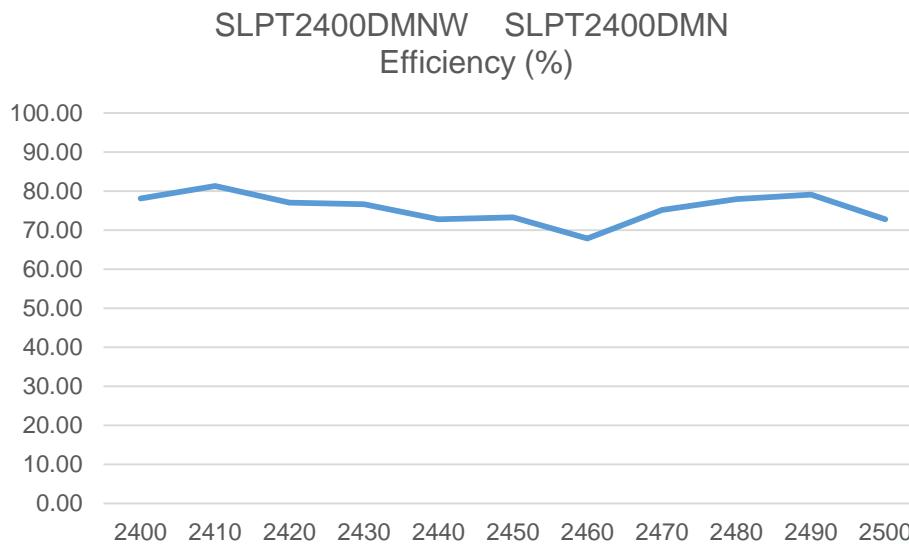
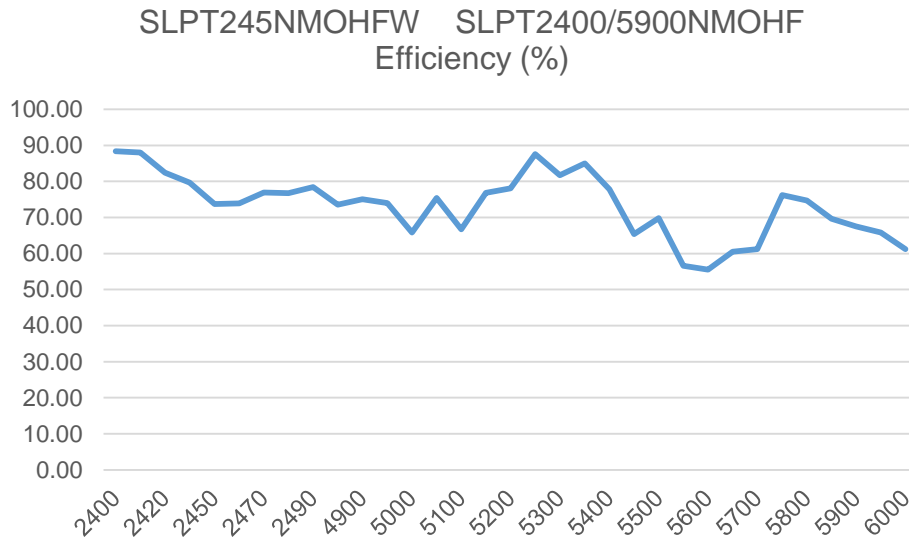

Issue: 1829

In the effort to improve our products, we reserve the right to make changes judged to be necessary.

CONFIDENTIAL AND PROPRIETARY INFORMATION

This document contains confidential and proprietary information of Pulse Electronics, Inc. (Pulse) and is protected by copyright, trade secret and other state and federal laws. Its receipt or possession does not convey any rights to reproduce, disclose its contents, or to manufacture, use or sell anything it may describe. Reproduction, disclosure or use without specific written authorization of Pulse is strictly forbidden.

**Description: ON-VEHICLE LOW PROFILE ANTENNA**

**Series: Shadow**

**PART NUMBER: Black: SLPTXXX / White: SLPTXXXW**

**CHARTS**

**Efficiency(%)**

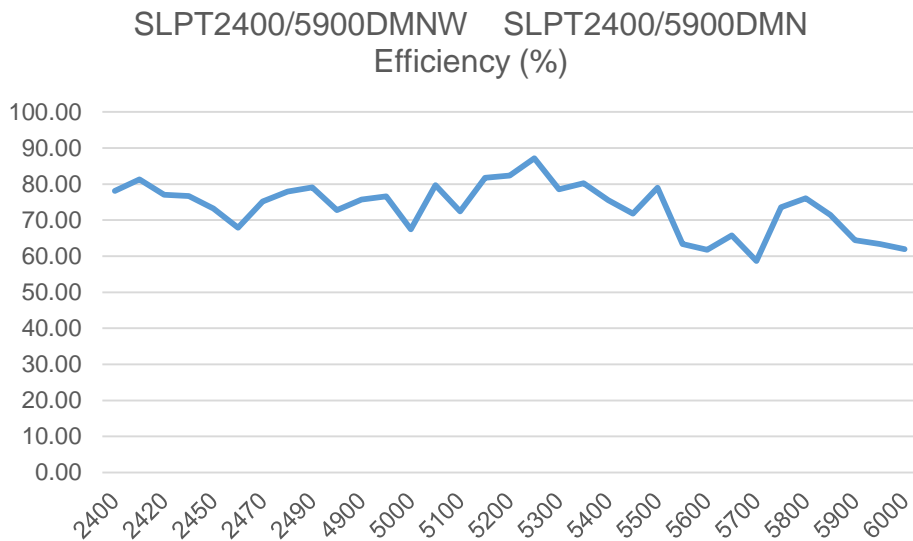
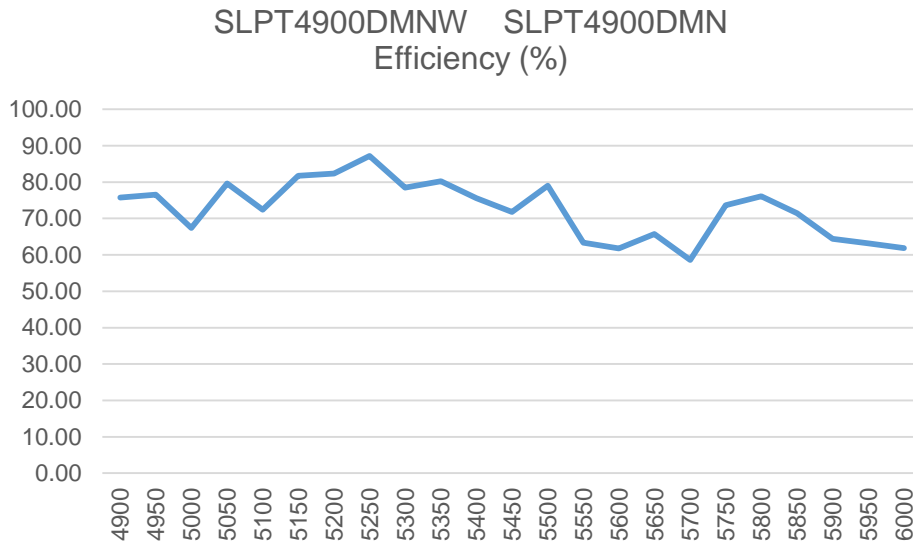

Issue: 1829

In the effort to improve our products, we reserve the right to make changes judged to be necessary.

CONFIDENTIAL AND PROPRIETARY INFORMATION

This document contains confidential and proprietary information of Pulse Electronics, Inc. (Pulse) and is protected by copyright, trade secret and other state and federal laws. Its receipt or possession does not convey any rights to reproduce, disclose its contents, or to manufacture, use or sell anything it may describe. Reproduction, disclosure or use without specific written authorization of Pulse is strictly forbidden.

Description: ON-VEHICLE LOW PROFILE ANTENNA

Series: Shadow

PART NUMBER: Black: SLPTXXX / White: SLPTXXXW

CHARTS

Peak Gain (dBi)

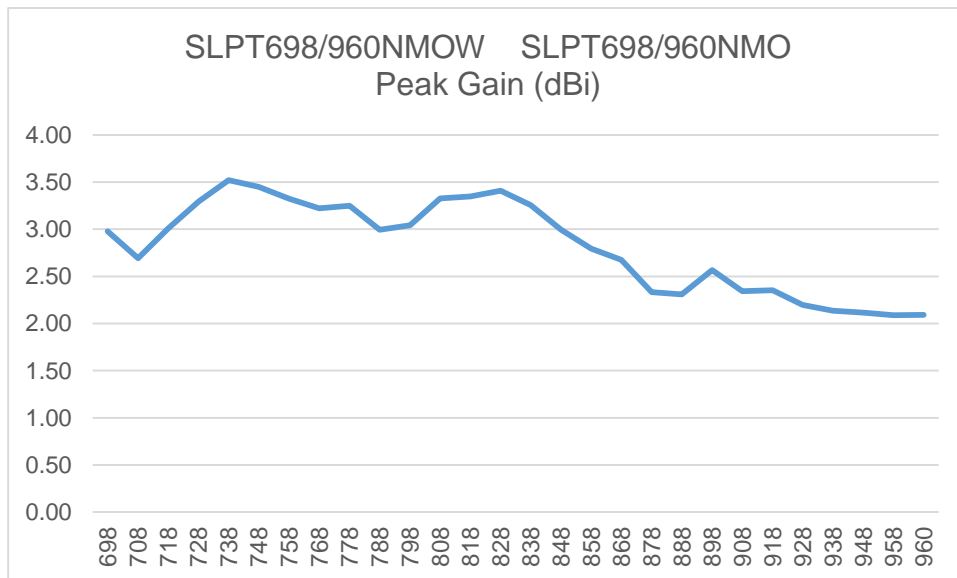
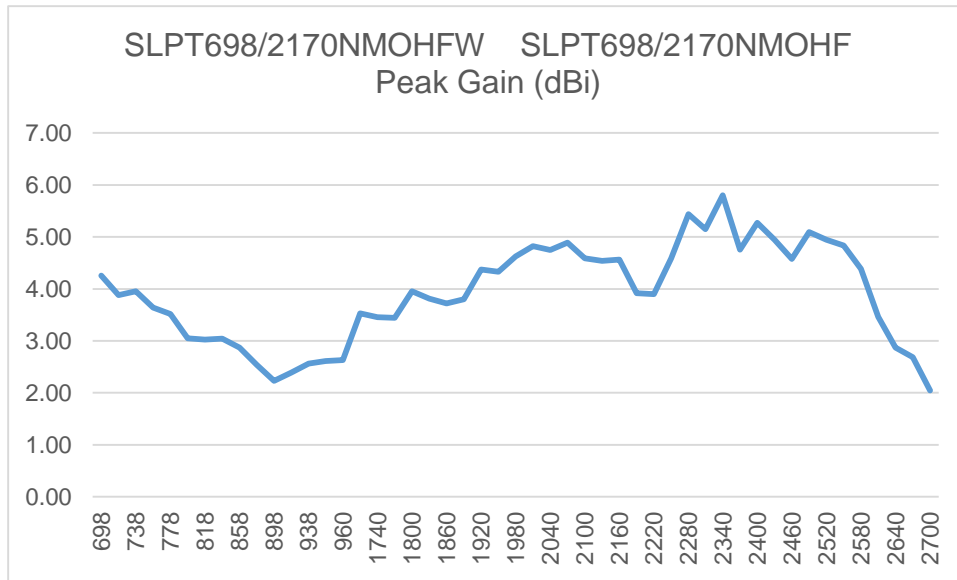

Issue: 1829

In the effort to improve our products, we reserve the right to make changes judged to be necessary.

CONFIDENTIAL AND PROPRIETARY INFORMATION

This document contains confidential and proprietary information of Pulse Electronics, Inc. (Pulse) and is protected by copyright, trade secret and other state and federal laws. Its receipt or possession does not convey any rights to reproduce, disclose its contents, or to manufacture, use or sell anything it may describe. Reproduction, disclosure or use without specific written authorization of Pulse is strictly forbidden.



Description: ON-VEHICLE LOW PROFILE ANTENNA

Series: Shadow

PART NUMBER: Black: SLPTXXX / White: SLPTXXXW

CHARTS

Peak Gain (dBi)

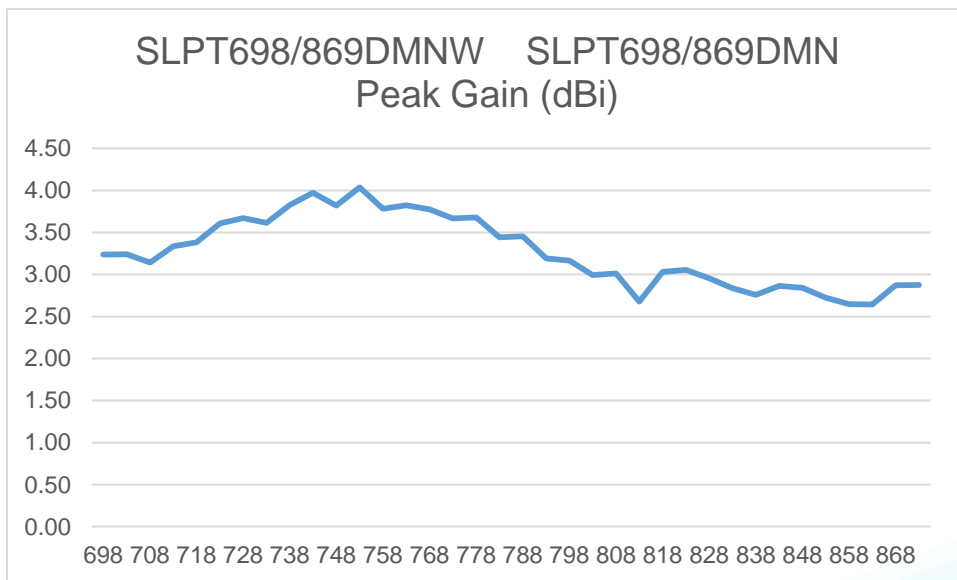
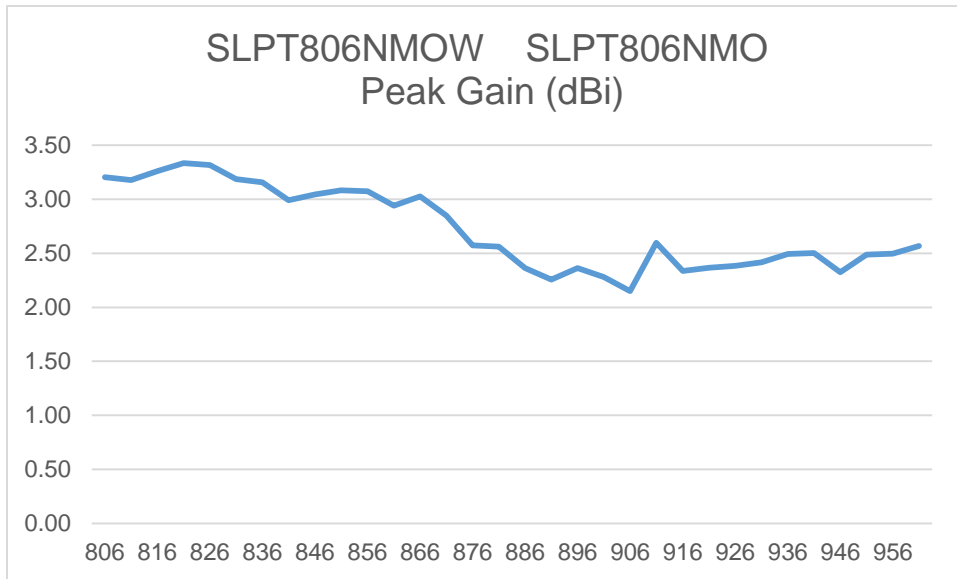

Issue: 1829

In the effort to improve our products, we reserve the right to make changes judged to be necessary.

CONFIDENTIAL AND PROPRIETARY INFORMATION

This document contains confidential and proprietary information of Pulse Electronics, Inc. (Pulse) and is protected by copyright, trade secret and other state and federal laws. Its receipt or possession does not convey any rights to reproduce, disclose its contents, or to manufacture, use or sell anything it may describe. Reproduction, disclosure or use without specific written authorization of Pulse is strictly forbidden.

Description: ON-VEHICLE LOW PROFILE ANTENNA

Series: Shadow

PART NUMBER: Black: SLPTXXX / White: SLPTXXXW

**CHARTS**

Peak Gain (dBi)

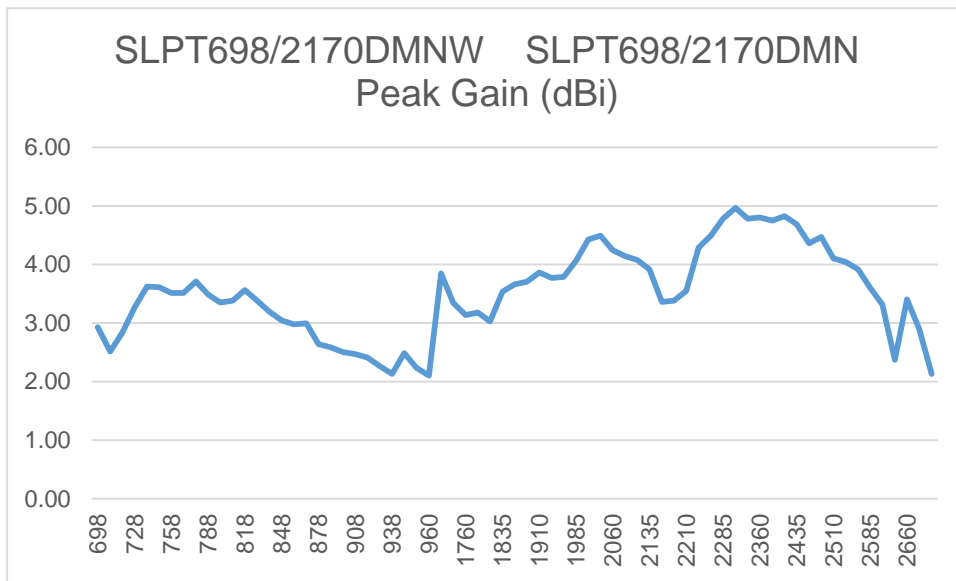
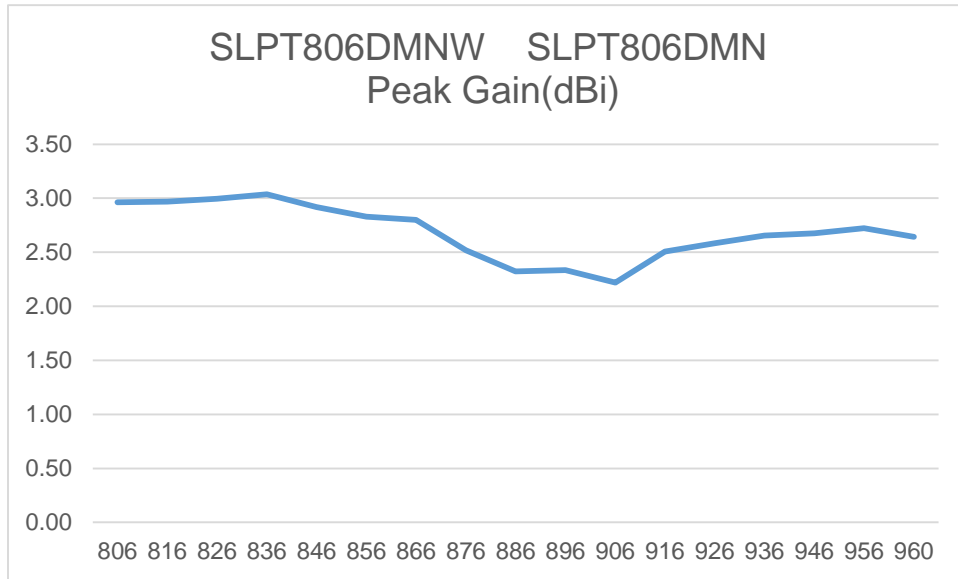

Issue: 1829

In the effort to improve our products, we reserve the right to make changes judged to be necessary.

CONFIDENTIAL AND PROPRIETARY INFORMATION

This document contains confidential and proprietary information of Pulse Electronics, Inc. (Pulse) and is protected by copyright, trade secret and other state and federal laws. Its receipt or possession does not convey any rights to reproduce, disclose its contents, or to manufacture, use or sell anything it may describe. Reproduction, disclosure or use without specific written authorization of Pulse is strictly forbidden.



**Description: ON-VEHICLE LOW PROFILE ANTENNA**

**Series: Shadow**

**PART NUMBER: Black: SLPTXXX / White: SLPTXXXW**

**CHARTS**

**Peak Gain (dBi)**

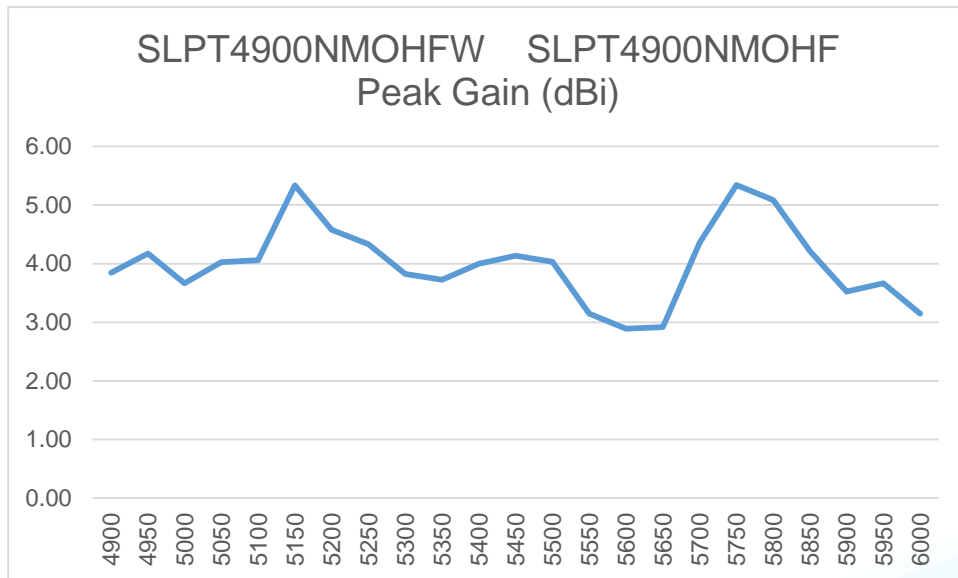
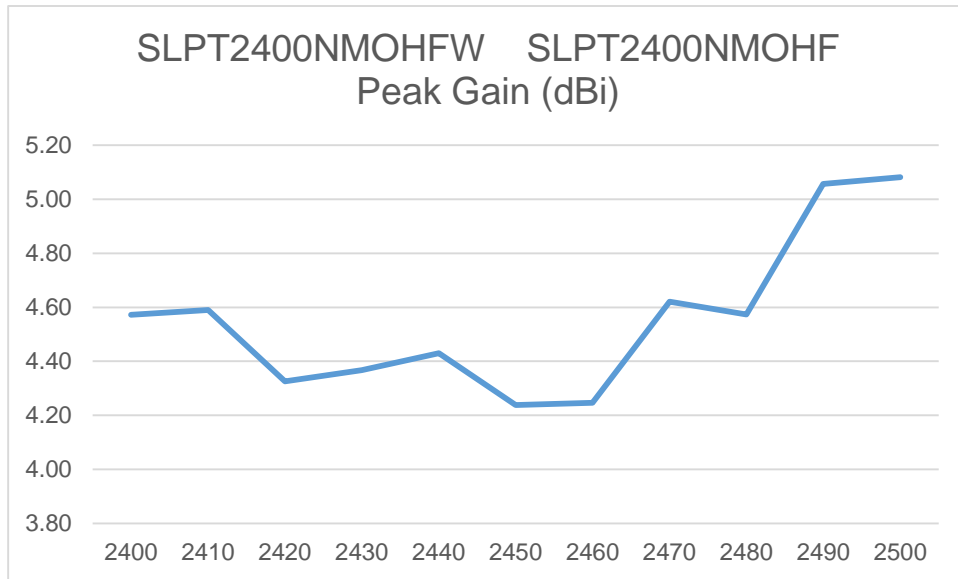

Issue: 1829

In the effort to improve our products, we reserve the right to make changes judged to be necessary.

CONFIDENTIAL AND PROPRIETARY INFORMATION

This document contains confidential and proprietary information of Pulse Electronics, Inc. (Pulse) and is protected by copyright, trade secret and other state and federal laws. Its receipt or possession does not convey any rights to reproduce, disclose its contents, or to manufacture, use or sell anything it may describe. Reproduction, disclosure or use without specific written authorization of Pulse is strictly forbidden.

Description: ON-VEHICLE LOW PROFILE ANTENNA

Series: Shadow

PART NUMBER: Black: SLPTXXX / White: SLPTXXXW

**CHARTS**

Peak Gain (dBi)

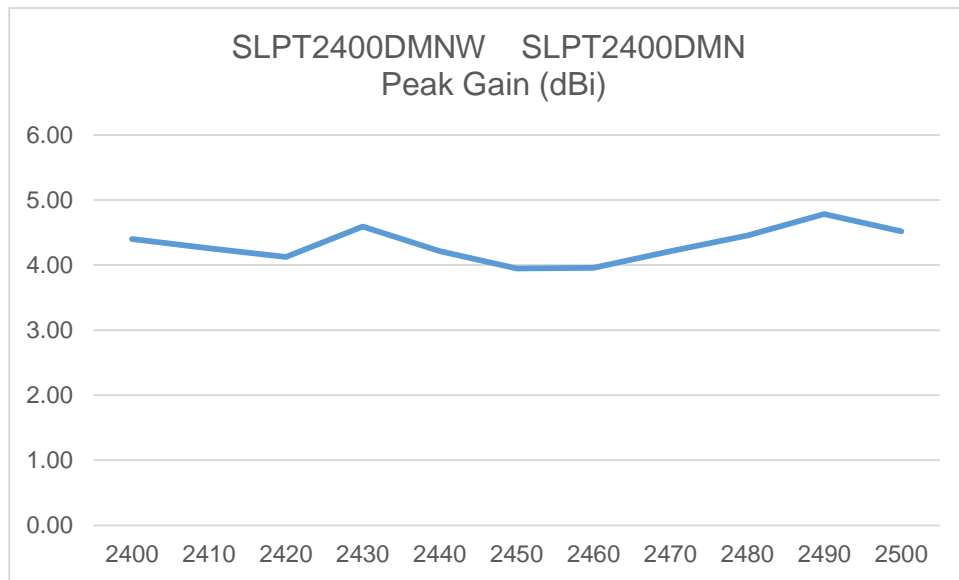
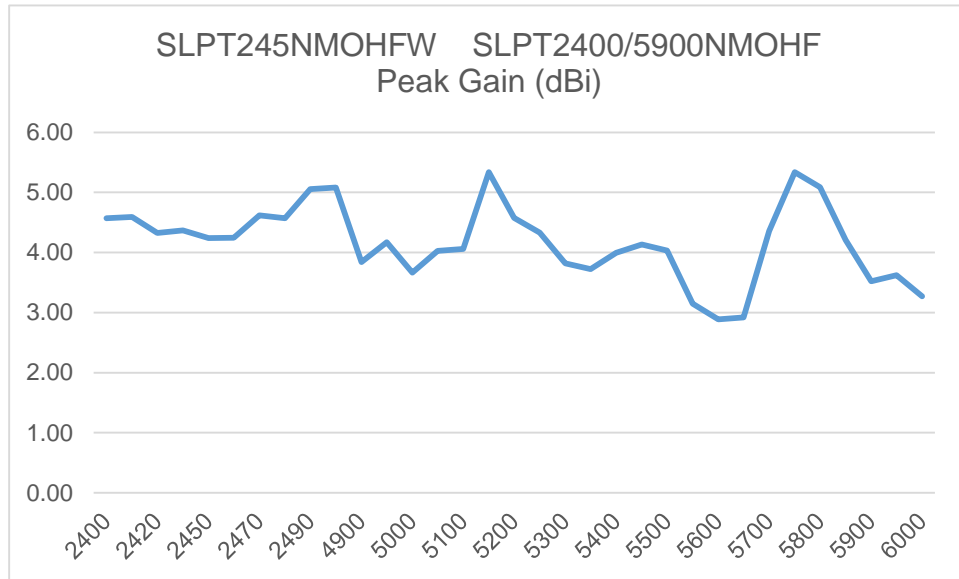

Issue: 1829

In the effort to improve our products, we reserve the right to make changes judged to be necessary.

CONFIDENTIAL AND PROPRIETARY INFORMATION

This document contains confidential and proprietary information of Pulse Electronics, Inc. (Pulse) and is protected by copyright, trade secret and other state and federal laws. Its receipt or possession does not convey any rights to reproduce, disclose its contents, or to manufacture, use or sell anything it may describe. Reproduction, disclosure or use without specific written authorization of Pulse is strictly forbidden.

Description: ON-VEHICLE LOW PROFILE ANTENNA

Series: Shadow

PART NUMBER: Black: SLPTXXX / White: SLPTXXXW

CHARTS

Peak Gain (dBi)

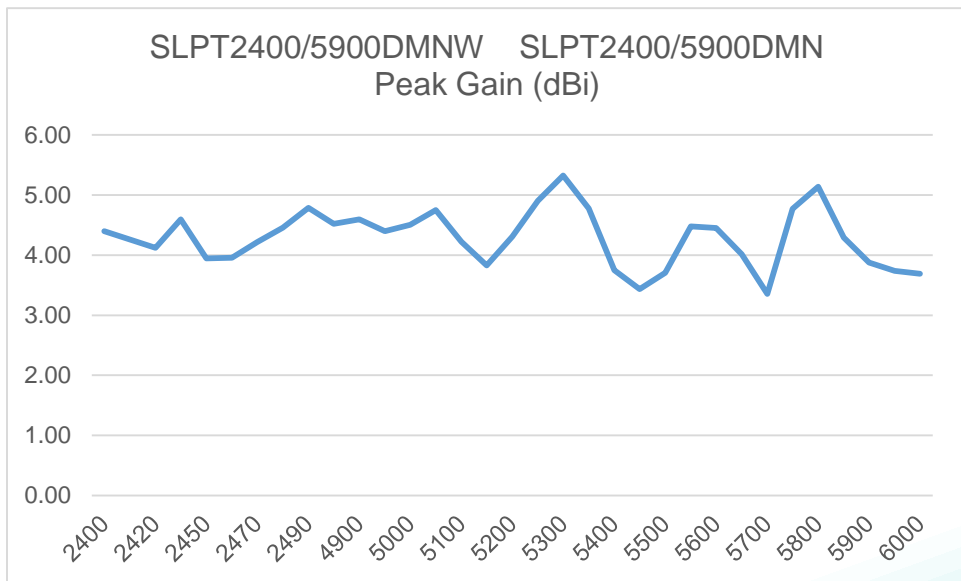
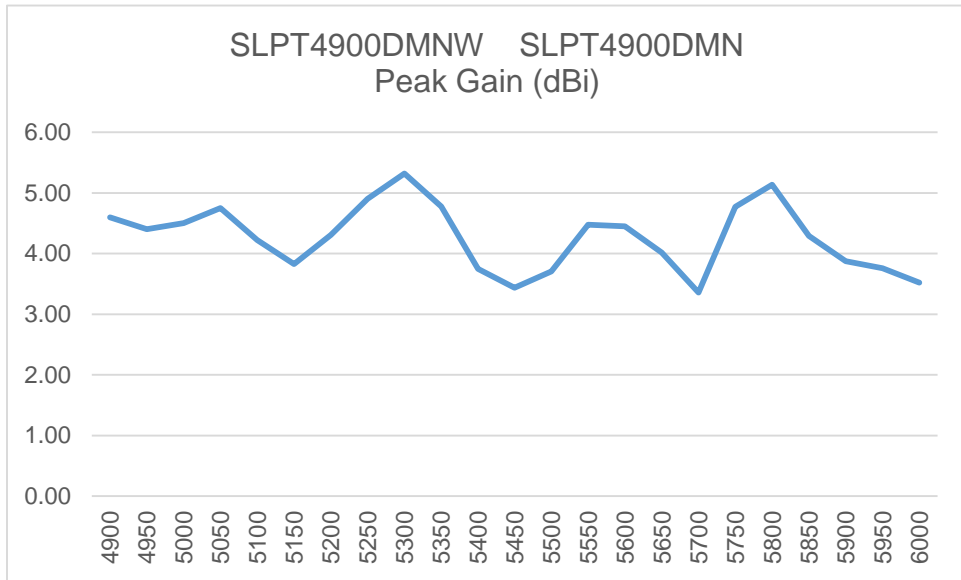

Issue: 1829

In the effort to improve our products, we reserve the right to make changes judged to be necessary.

CONFIDENTIAL AND PROPRIETARY INFORMATION

This document contains confidential and proprietary information of Pulse Electronics, Inc. (Pulse) and is protected by copyright, trade secret and other state and federal laws. Its receipt or possession does not convey any rights to reproduce, disclose its contents, or to manufacture, use or sell anything it may describe. Reproduction, disclosure or use without specific written authorization of Pulse is strictly forbidden.



Description: ON-VEHICLE LOW PROFILE ANTENNA

Series: Shadow

PART NUMBER: Black: SLPTXXX / White: SLPTXXXW

CHARTS

Free Space Radiation Pattern

SLPT698/2170NMOHFW SLPT698/2170NMOHF

Elevation Plane

Horizontal Plane

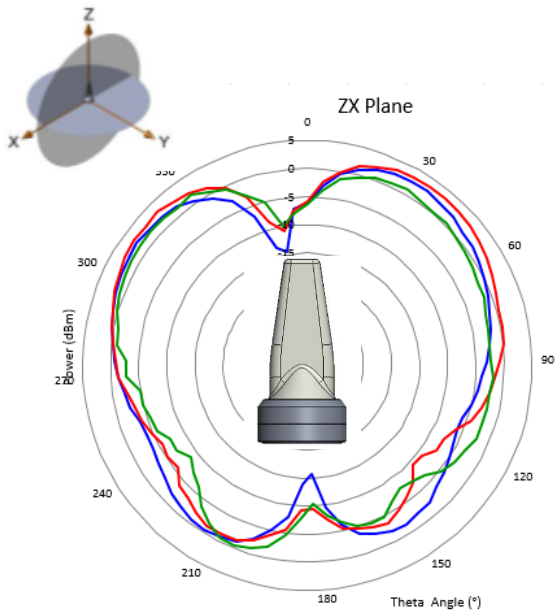

— 698MHz  
— 836MHz  
— 960MHz

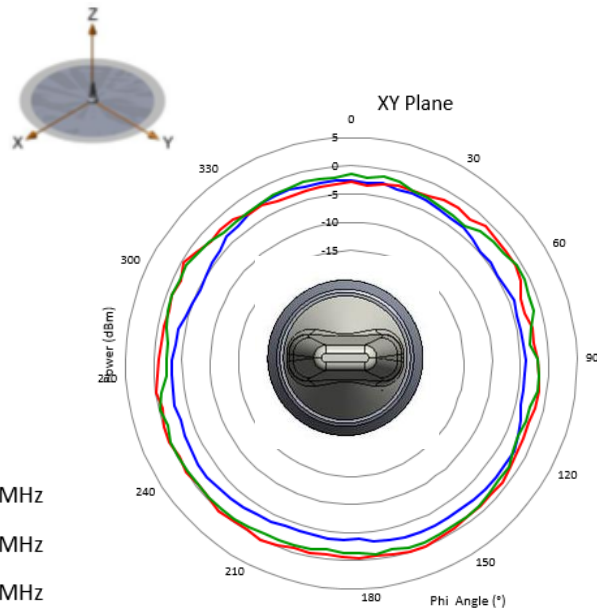

— 698MHz  
— 836MHz  
— 960MHz

Issue: 1829

In the effort to improve our products, we reserve the right to make changes judged to be necessary.

CONFIDENTIAL AND PROPRIETARY INFORMATION

This document contains confidential and proprietary information of Pulse Electronics, Inc. (Pulse) and is protected by copyright, trade secret and other state and federal laws. Its receipt or possession does not convey any rights to reproduce, disclose its contents, or to manufacture, use or sell anything it may describe. Reproduction, disclosure or use without specific written authorization of Pulse is strictly forbidden.

Description: ON-VEHICLE LOW PROFILE ANTENNA

Series: Shadow

PART NUMBER: Black: SLPTXXX / White: SLPTXXXW

CHARTS

Free Space Radiation Pattern

SLPT698/2170NMOHFW SLPT698/2170NMOHF

Elevation Plane

Horizontal Plane

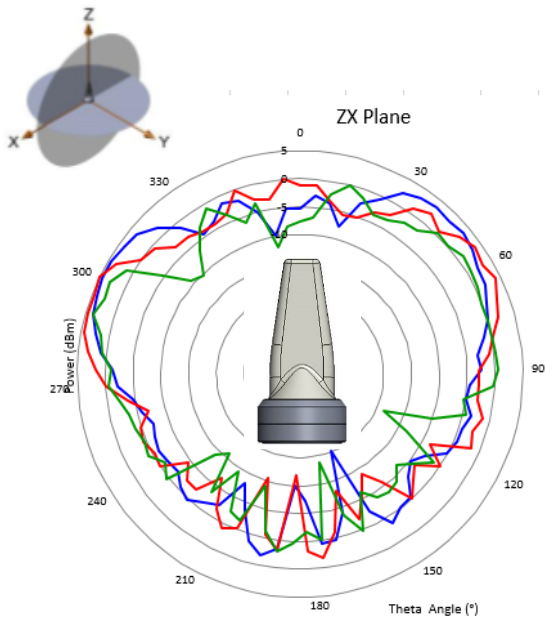

— 1710MHz  
— 2200MHz  
— 2690MHz

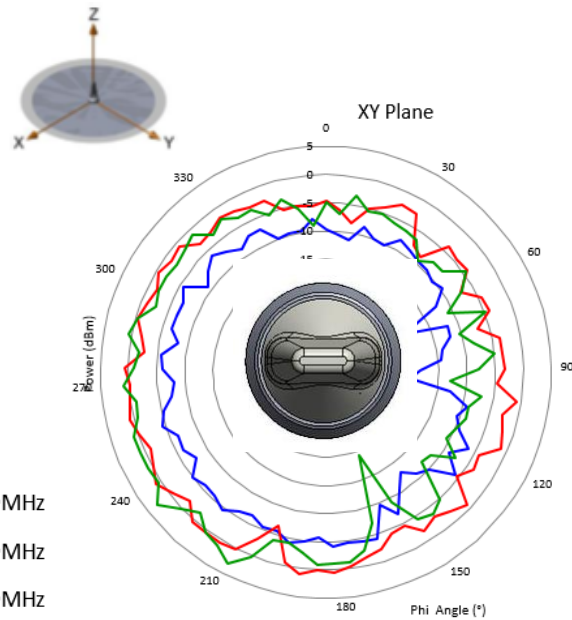

— 1710MHz  
— 2200MHz  
— 2690MHz

Issue: 1829

In the effort to improve our products, we reserve the right to make changes judged to be necessary.

CONFIDENTIAL AND PROPRIETARY INFORMATION

This document contains confidential and proprietary information of Pulse Electronics, Inc. (Pulse) and is protected by copyright, trade secret and other state and federal laws. Its receipt or possession does not convey any rights to reproduce, disclose its contents, or to manufacture, use or sell anything it may describe. Reproduction, disclosure or use without specific written authorization of Pulse is strictly forbidden.

Description: ON-VEHICLE LOW PROFILE ANTENNA

Series: Shadow

PART NUMBER: Black: SLPTXXX / White: SLPTXXXW

CHARTS

Free Space Radiation Pattern

SLPT698/960NMOW SLPT698/960NMO

Elevation Plane

Horizontal Plane

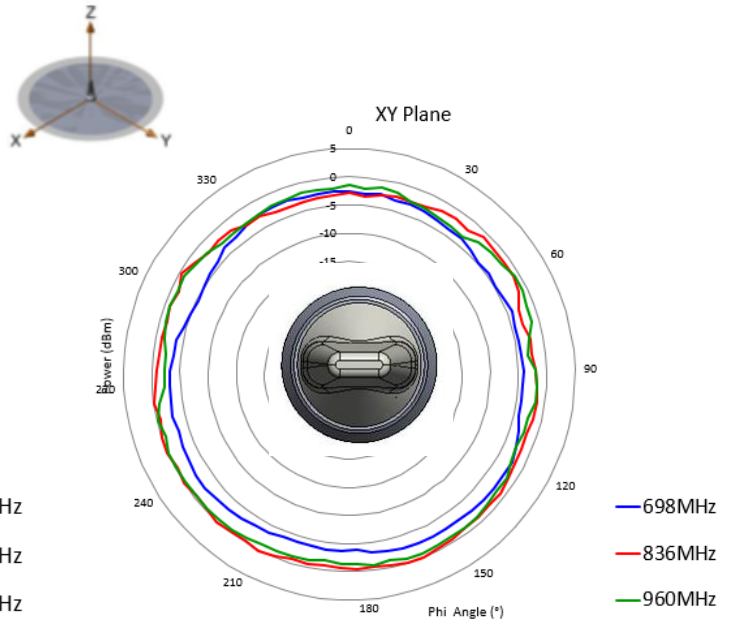
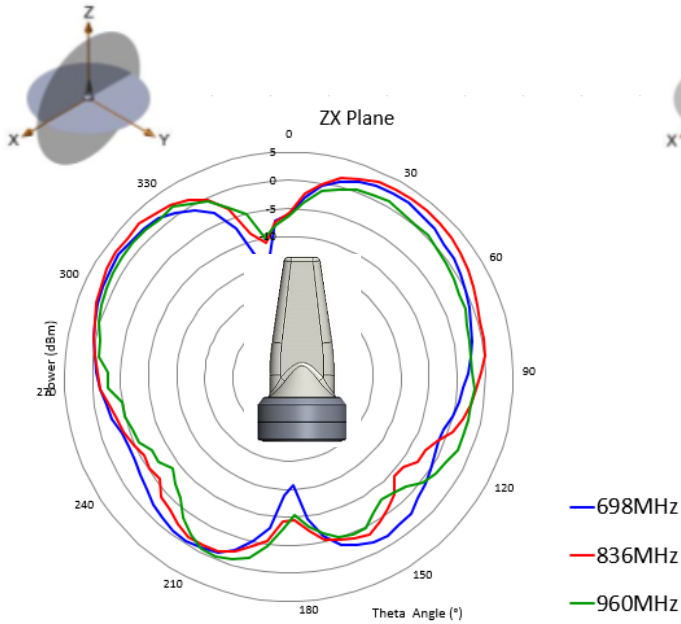

Issue: 1829

In the effort to improve our products, we reserve the right to make changes judged to be necessary.

CONFIDENTIAL AND PROPRIETARY INFORMATION

This document contains confidential and proprietary information of Pulse Electronics, Inc. (Pulse) and is protected by copyright, trade secret and other state and federal laws. Its receipt or possession does not convey any rights to reproduce, disclose its contents, or to manufacture, use or sell anything it may describe. Reproduction, disclosure or use without specific written authorization of Pulse is strictly forbidden.

Description: ON-VEHICLE LOW PROFILE ANTENNA

Series: Shadow

PART NUMBER: Black: SLPTXXX / White: SLPTXXXW

CHARTS

Free Space Radiation Pattern

SLPT806NMOW SLPT806NMO

Elevation Plane

Horizontal Plane

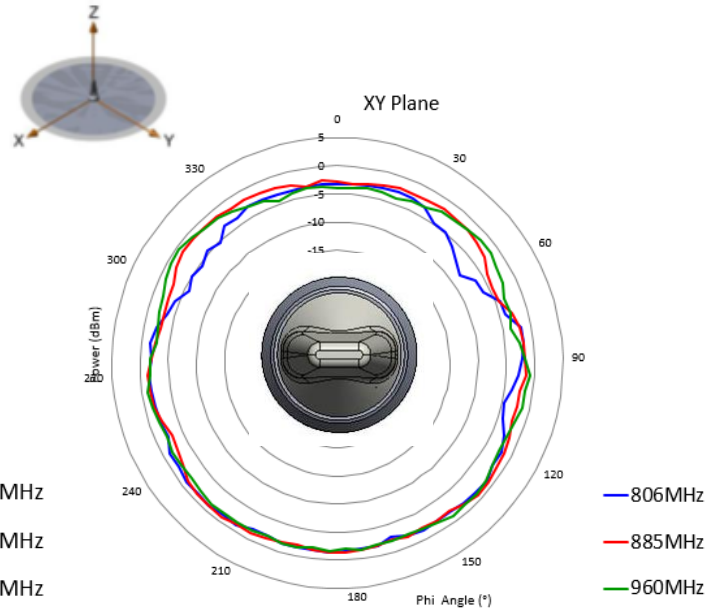
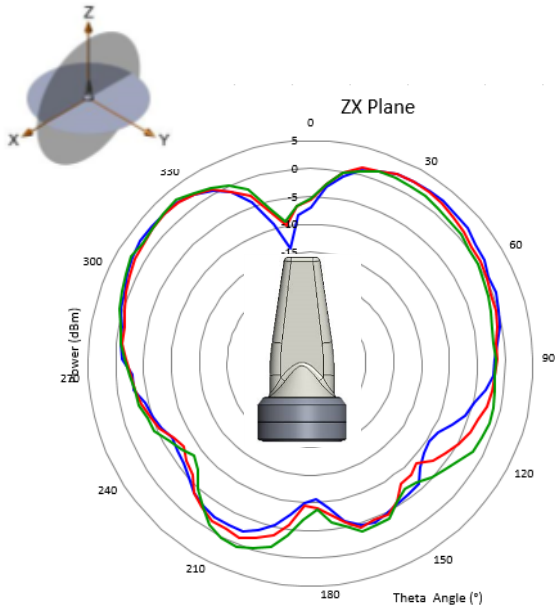

Issue: 1829

In the effort to improve our products, we reserve the right to make changes judged to be necessary.

CONFIDENTIAL AND PROPRIETARY INFORMATION

This document contains confidential and proprietary information of Pulse Electronics, Inc. (Pulse) and is protected by copyright, trade secret and other state and federal laws. Its receipt or possession does not convey any rights to reproduce, disclose its contents, or to manufacture, use or sell anything it may describe. Reproduction, disclosure or use without specific written authorization of Pulse is strictly forbidden.

Description: ON-VEHICLE LOW PROFILE ANTENNA

Series: Shadow

PART NUMBER: Black: SLPTXXX / White: SLPTXXXW

CHARTS

Free Space Radiation Pattern

SLPT698/869DMNW SLPT698/869DMN

Elevation Plane

Horizontal Plane

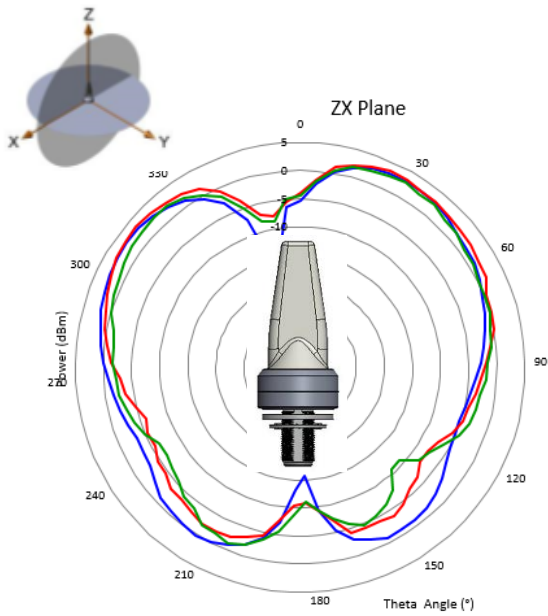

— 698MHz  
— 784MHz  
— 869MHz

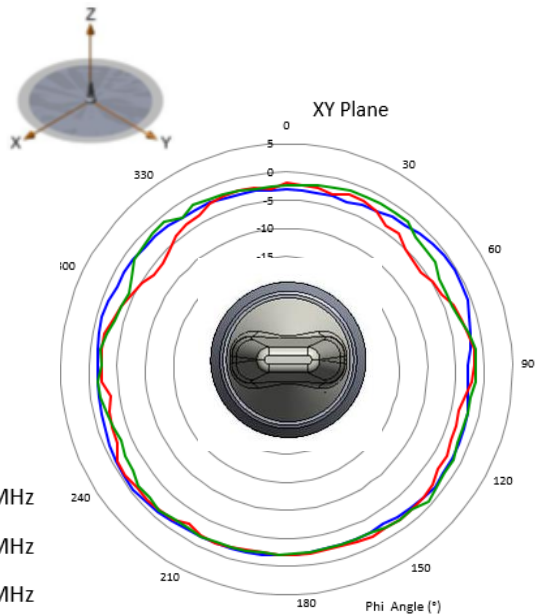

— 698MHz  
— 784MHz  
— 869MHz

Issue: 1829

In the effort to improve our products, we reserve the right to make changes judged to be necessary.

CONFIDENTIAL AND PROPRIETARY INFORMATION

This document contains confidential and proprietary information of Pulse Electronics, Inc. (Pulse) and is protected by copyright, trade secret and other state and federal laws. Its receipt or possession does not convey any rights to reproduce, disclose its contents, or to manufacture, use or sell anything it may describe. Reproduction, disclosure or use without specific written authorization of Pulse is strictly forbidden.

Description: ON-VEHICLE LOW PROFILE ANTENNA

Series: Shadow

PART NUMBER: Black: SLPTXXX / White: SLPTXXXW

**CHARTS**

Free Space Radiation Pattern

SLPT806DMNW SLPT806DMN

Elevation Plane

Horizontal Plane

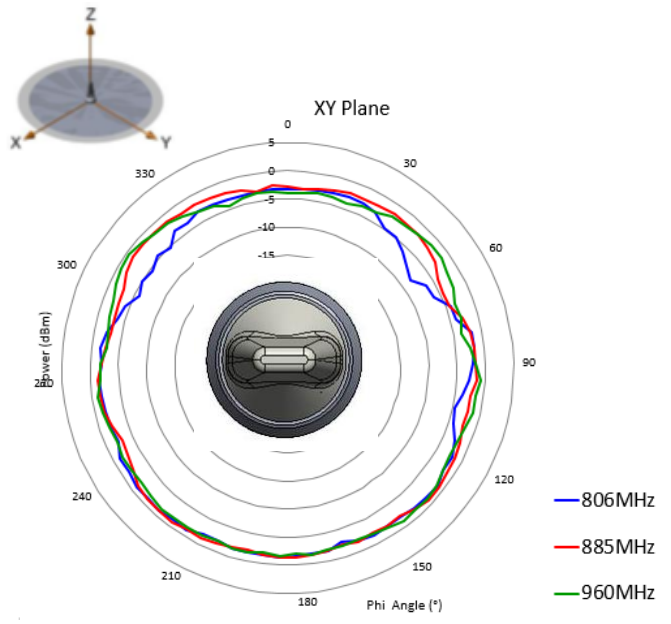
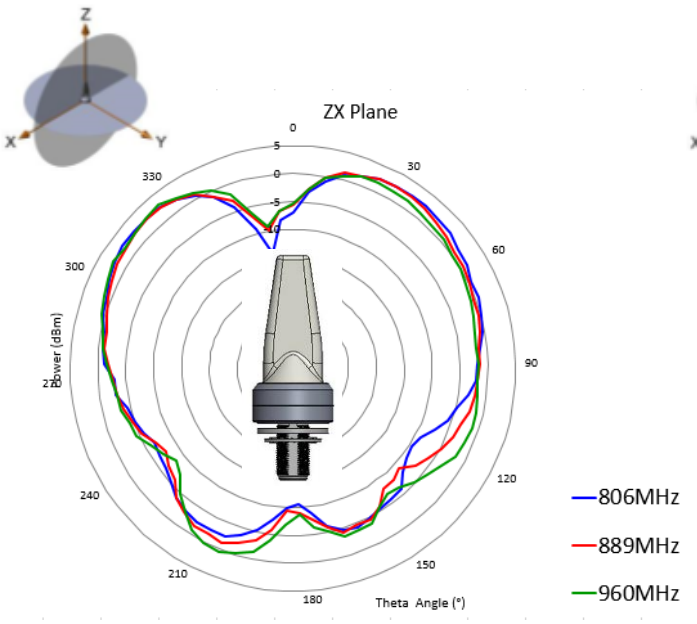

Issue: 1829

In the effort to improve our products, we reserve the right to make changes judged to be necessary.

CONFIDENTIAL AND PROPRIETARY INFORMATION

This document contains confidential and proprietary information of Pulse Electronics, Inc. (Pulse) and is protected by copyright, trade secret and other state and federal laws. Its receipt or possession does not convey any rights to reproduce, disclose its contents, or to manufacture, use or sell anything it may describe. Reproduction, disclosure or use without specific written authorization of Pulse is strictly forbidden.

Description: ON-VEHICLE LOW PROFILE ANTENNA

Series: Shadow

PART NUMBER: Black: SLPTXXX / White: SLPTXXXW

CHARTS

Free Space Radiation Pattern

SLPT698/2170DMNW SLPT698/2170DMN

Elevation Plane

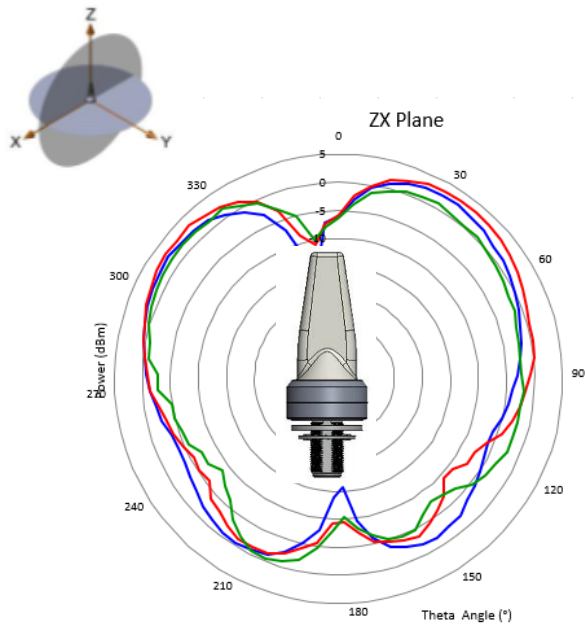

Horizontal Plane

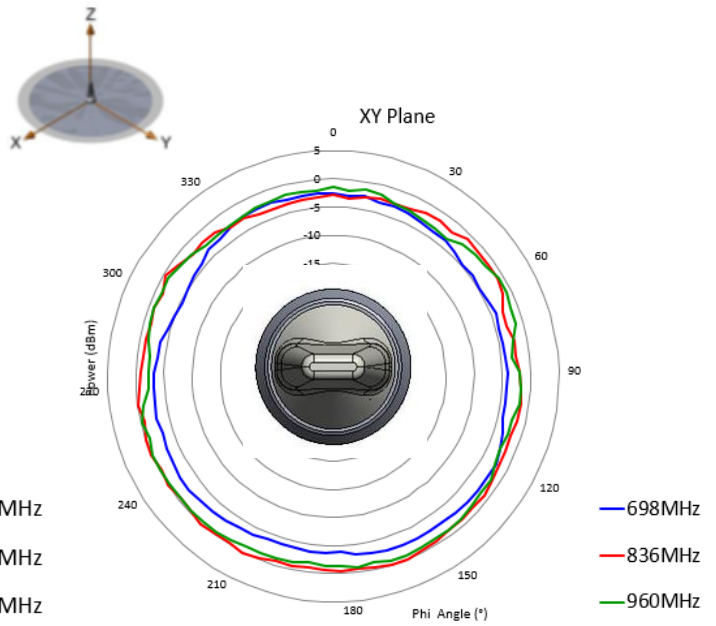

Issue: 1829

In the effort to improve our products, we reserve the right to make changes judged to be necessary.

CONFIDENTIAL AND PROPRIETARY INFORMATION

This document contains confidential and proprietary information of Pulse Electronics, Inc. (Pulse) and is protected by copyright, trade secret and other state and federal laws. Its receipt or possession does not convey any rights to reproduce, disclose its contents, or to manufacture, use or sell anything it may describe. Reproduction, disclosure or use without specific written authorization of Pulse is strictly forbidden.

Description: ON-VEHICLE LOW PROFILE ANTENNA

Series: Shadow

PART NUMBER: Black: SLPTXXX / White: SLPTXXXW

CHARTS

Free Space Radiation Pattern

SLPT698/2170DMNW SLPT698/2170DMN

Elevation Plane

Horizontal Plane

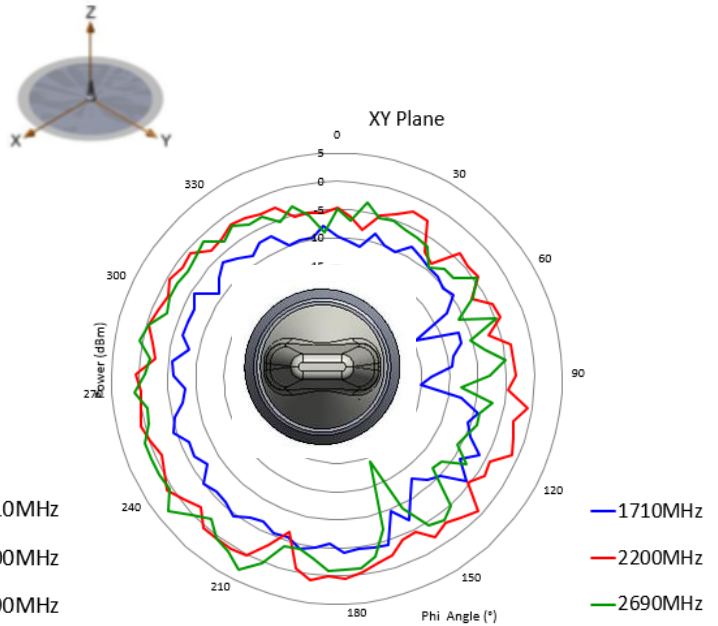
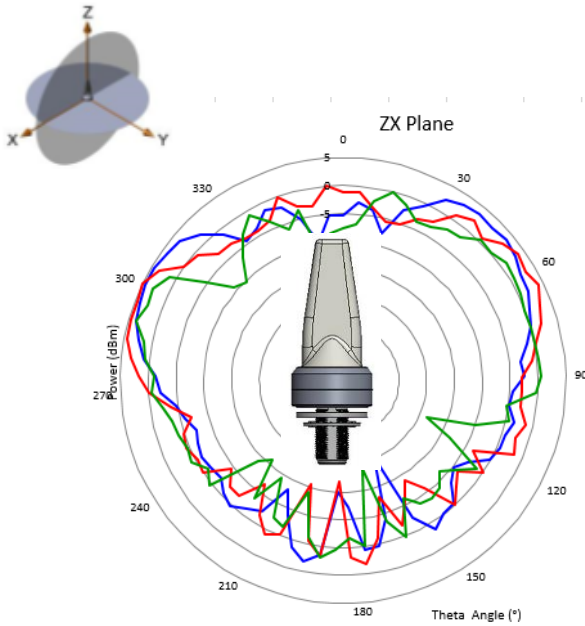

Issue: 1829

In the effort to improve our products, we reserve the right to make changes judged to be necessary.

CONFIDENTIAL AND PROPRIETARY INFORMATION

This document contains confidential and proprietary information of Pulse Electronics, Inc. (Pulse) and is protected by copyright, trade secret and other state and federal laws. Its receipt or possession does not convey any rights to reproduce, disclose its contents, or to manufacture, use or sell anything it may describe. Reproduction, disclosure or use without specific written authorization of Pulse is strictly forbidden.



Description: ON-VEHICLE LOW PROFILE ANTENNA

Series: Shadow

PART NUMBER: Black: SLPTXXX / White: SLPTXXXW

CHARTS

Free Space Radiation Pattern

SLPT2400NMOHFW SLPT2400NMOHF

Elevation Plane

Horizontal Plane

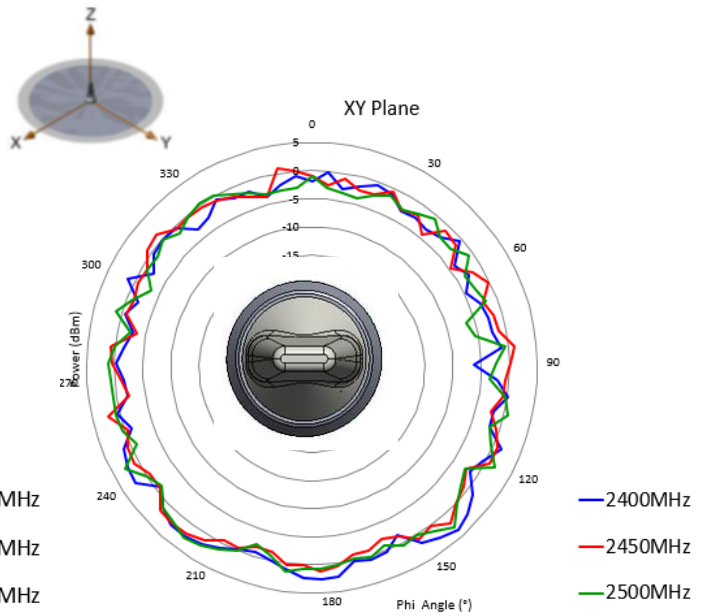
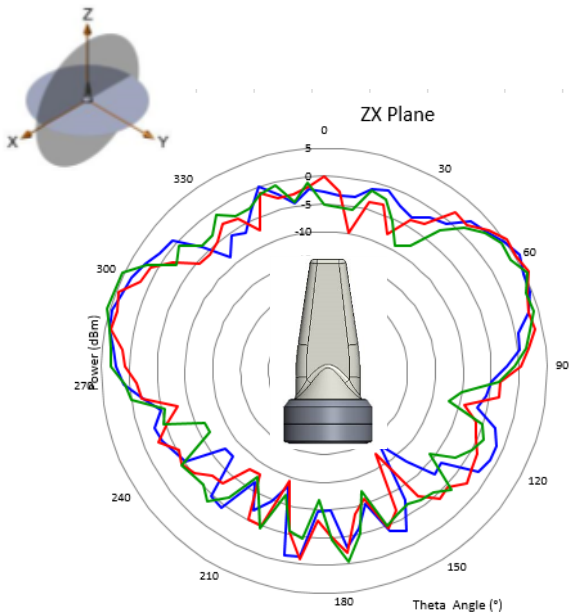

Issue: 1829

In the effort to improve our products, we reserve the right to make changes judged to be necessary.

CONFIDENTIAL AND PROPRIETARY INFORMATION

This document contains confidential and proprietary information of Pulse Electronics, Inc. (Pulse) and is protected by copyright, trade secret and other state and federal laws. Its receipt or possession does not convey any rights to reproduce, disclose its contents, or to manufacture, use or sell anything it may describe. Reproduction, disclosure or use without specific written authorization of Pulse is strictly forbidden.

Description: ON-VEHICLE LOW PROFILE ANTENNA

Series: Shadow

PART NUMBER: Black: SLPTXXX / White: SLPTXXXW

CHARTS

Free Space Radiation Pattern

SLPT4900NMOHFW SLPT4900NMOHF

Elevation Plane

Horizontal Plane

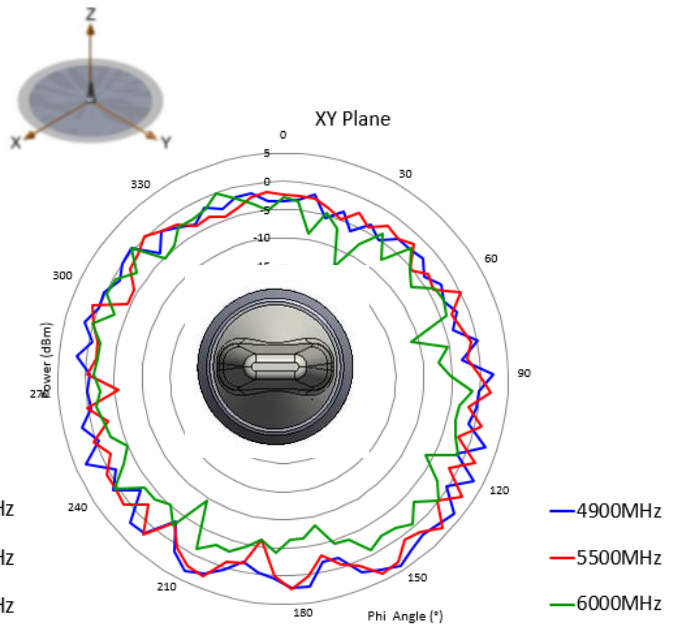
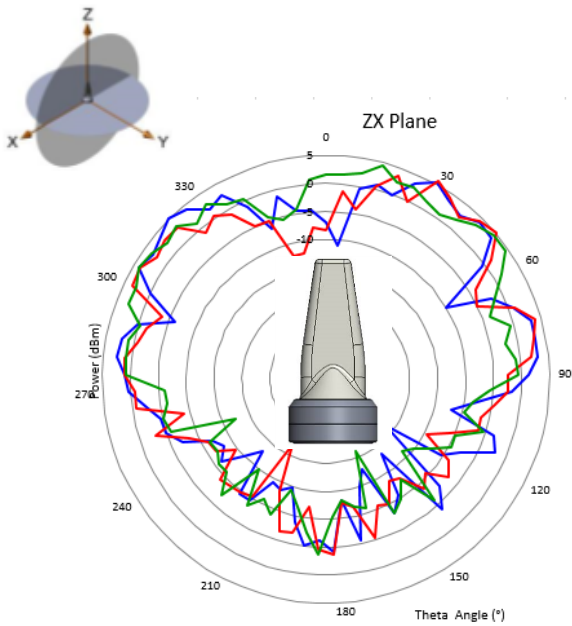

Issue: 1829

In the effort to improve our products, we reserve the right to make changes judged to be necessary.

CONFIDENTIAL AND PROPRIETARY INFORMATION

This document contains confidential and proprietary information of Pulse Electronics, Inc. (Pulse) and is protected by copyright, trade secret and other state and federal laws. Its receipt or possession does not convey any rights to reproduce, disclose its contents, or to manufacture, use or sell anything it may describe. Reproduction, disclosure or use without specific written authorization of Pulse is strictly forbidden.

Description: ON-VEHICLE LOW PROFILE ANTENNA

Series: Shadow

PART NUMBER: Black: SLPTXXX / White: SLPTXXXW

CHARTS

Free Space Radiation Pattern

SLPT245NMOHFW SLPT2400/5900NMOHF

Elevation Plane

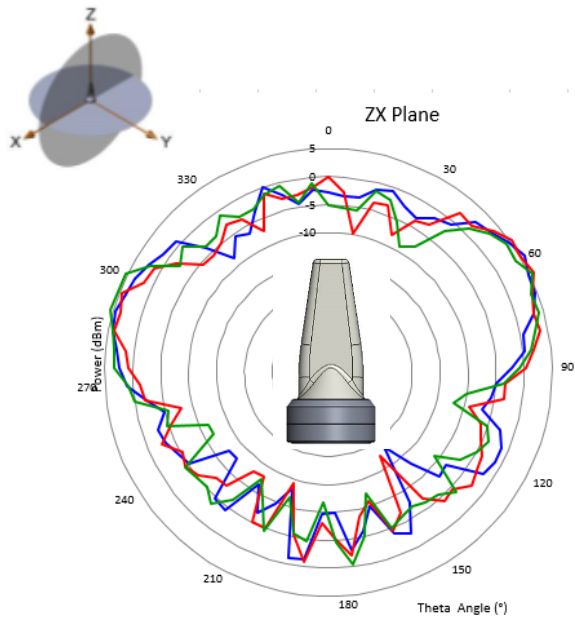

Horizontal Plane

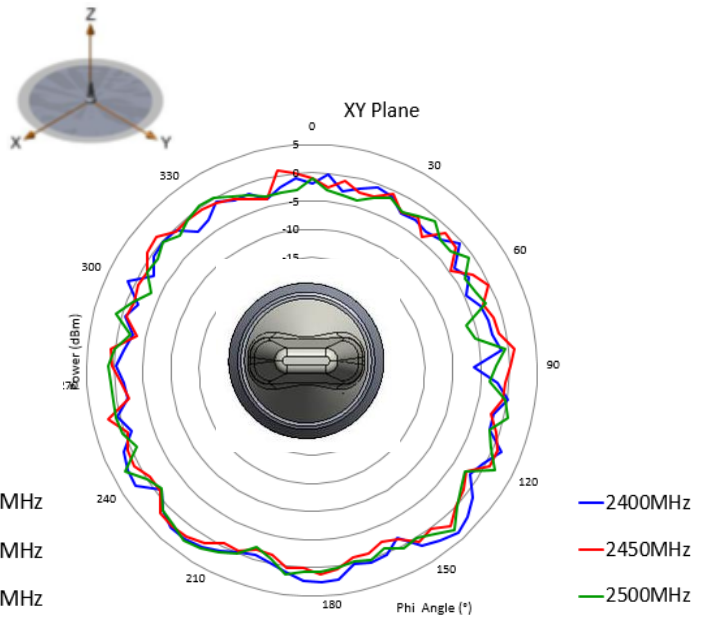

Issue: 1829

In the effort to improve our products, we reserve the right to make changes judged to be necessary.

CONFIDENTIAL AND PROPRIETARY INFORMATION

This document contains confidential and proprietary information of Pulse Electronics, Inc. (Pulse) and is protected by copyright, trade secret and other state and federal laws. Its receipt or possession does not convey any rights to reproduce, disclose its contents, or to manufacture, use or sell anything it may describe. Reproduction, disclosure or use without specific written authorization of Pulse is strictly forbidden.

Description: ON-VEHICLE LOW PROFILE ANTENNA

Series: Shadow

PART NUMBER: Black: SLPTXXX / White: SLPTXXXW

CHARTS

Free Space Radiation Pattern

SLPT245NMOHFW SLPT2400/5900NMOHF

Elevation Plane

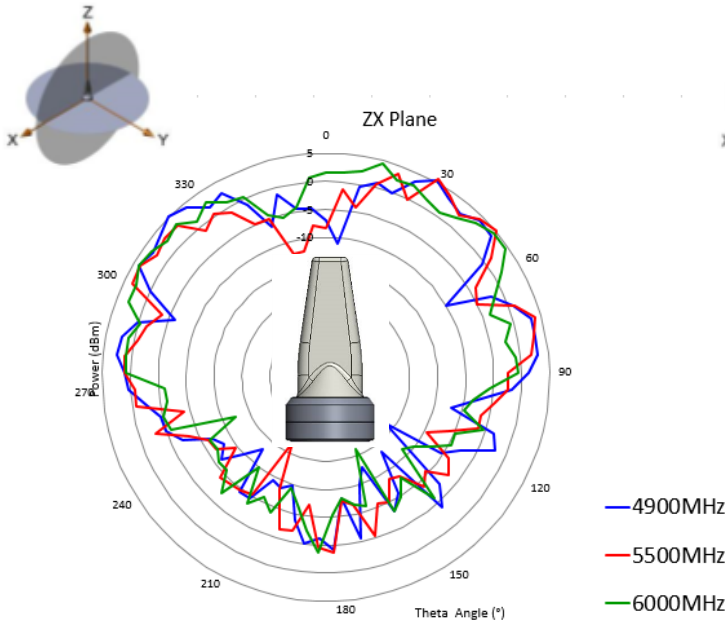

Horizontal Plane

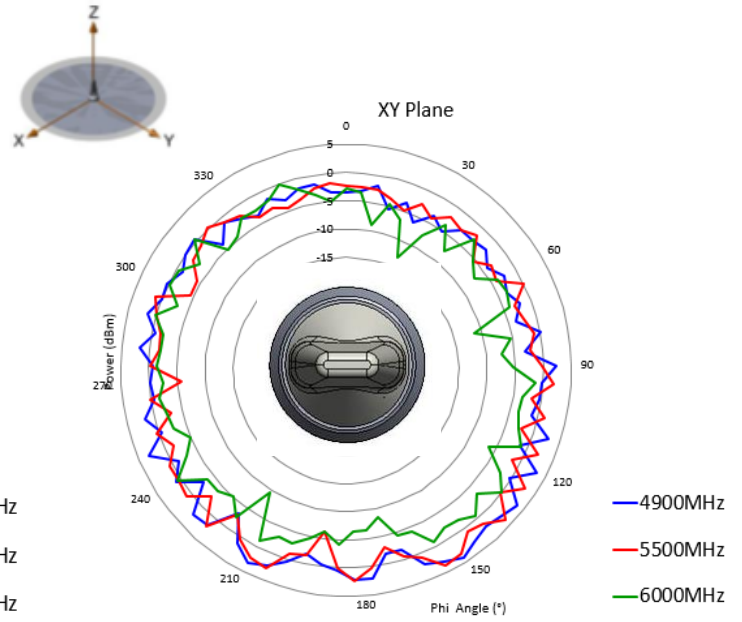

Issue: 1829

In the effort to improve our products, we reserve the right to make changes judged to be necessary.

CONFIDENTIAL AND PROPRIETARY INFORMATION

This document contains confidential and proprietary information of Pulse Electronics, Inc. (Pulse) and is protected by copyright, trade secret and other state and federal laws. Its receipt or possession does not convey any rights to reproduce, disclose its contents, or to manufacture, use or sell anything it may describe. Reproduction, disclosure or use without specific written authorization of Pulse is strictly forbidden.

Description: ON-VEHICLE LOW PROFILE ANTENNA

Series: Shadow

PART NUMBER: Black: SLPTXXX / White: SLPTXXXW

CHARTS

Free Space Radiation Pattern

SLPT2400DMNW SLPT2400DMN

Elevation Plane

Horizontal Plane

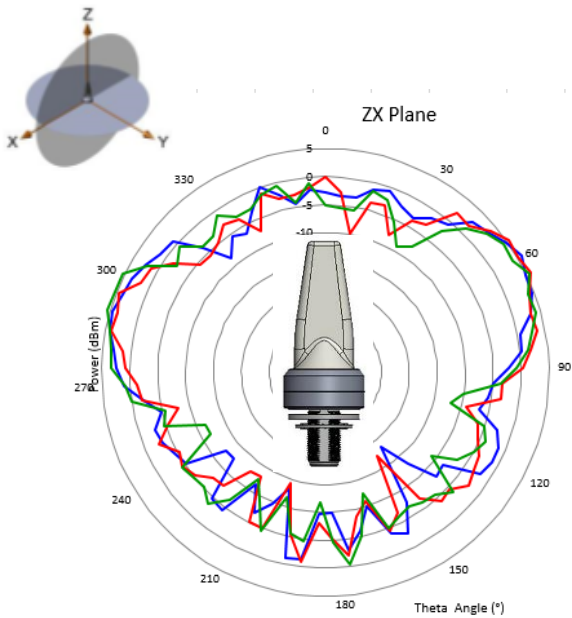

— 2400MHz  
— 2450MHz  
— 2500MHz

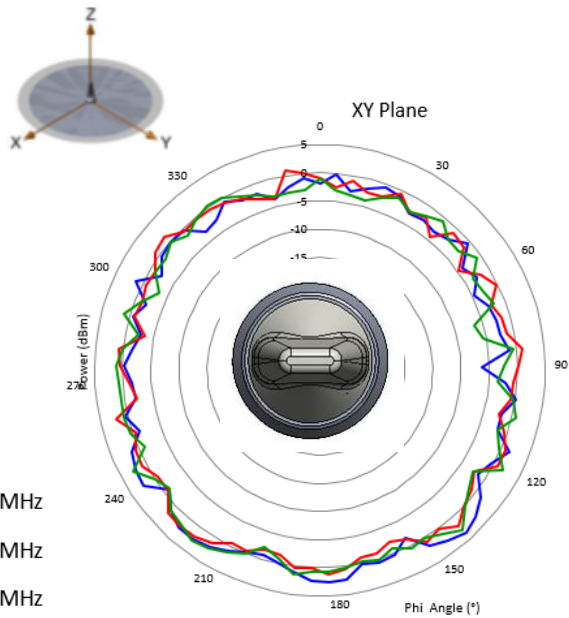

— 2400MHz  
— 2450MHz  
— 2500MHz

Issue: 1829

In the effort to improve our products, we reserve the right to make changes judged to be necessary.

CONFIDENTIAL AND PROPRIETARY INFORMATION

This document contains confidential and proprietary information of Pulse Electronics, Inc. (Pulse) and is protected by copyright, trade secret and other state and federal laws. Its receipt or possession does not convey any rights to reproduce, disclose its contents, or to manufacture, use or sell anything it may describe. Reproduction, disclosure or use without specific written authorization of Pulse is strictly forbidden.

Description: ON-VEHICLE LOW PROFILE ANTENNA

Series: Shadow

PART NUMBER: Black: SLPTXXX / White: SLPTXXXW

CHARTS

Free Space Radiation Pattern

SLPT4900DMNW SLPT4900DMN

Elevation Plane

Horizontal Plane

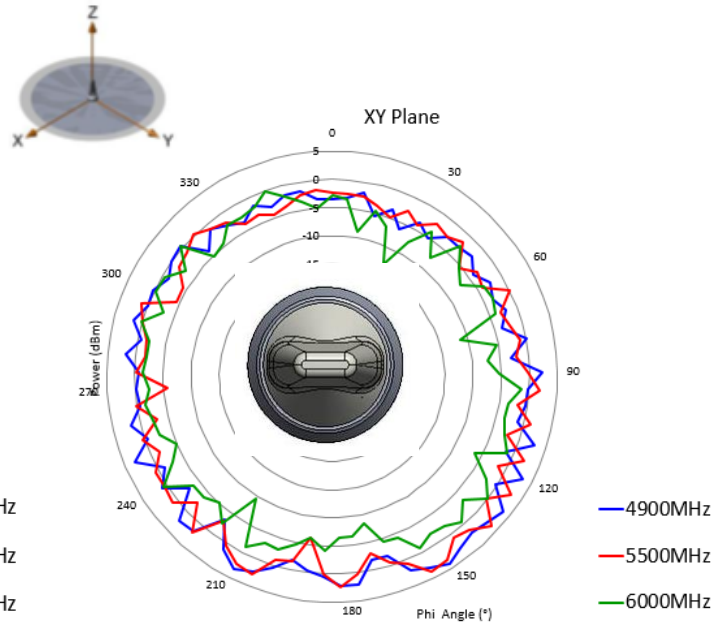
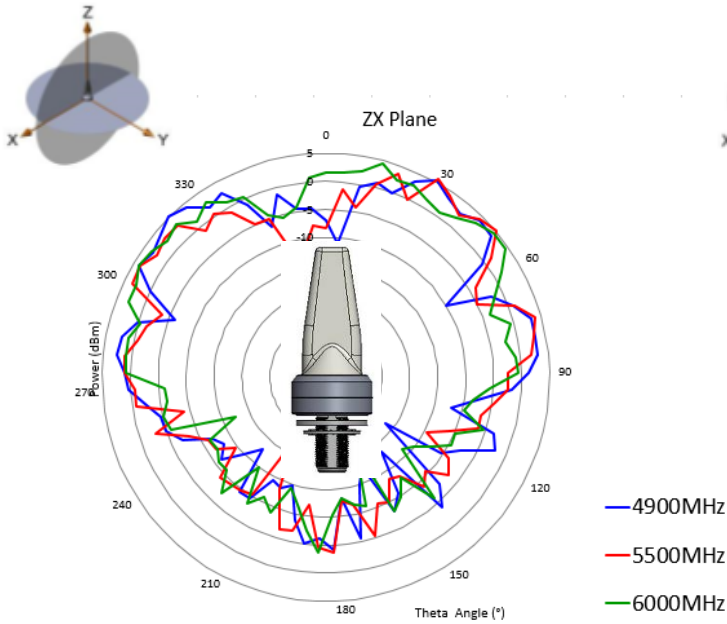

Issue: 1829

In the effort to improve our products, we reserve the right to make changes judged to be necessary.

CONFIDENTIAL AND PROPRIETARY INFORMATION

This document contains confidential and proprietary information of Pulse Electronics, Inc. (Pulse) and is protected by copyright, trade secret and other state and federal laws. Its receipt or possession does not convey any rights to reproduce, disclose its contents, or to manufacture, use or sell anything it may describe. Reproduction, disclosure or use without specific written authorization of Pulse is strictly forbidden.

Description: ON-VEHICLE LOW PROFILE ANTENNA

Series: Shadow

PART NUMBER: Black: SLPTXXX / White: SLPTXXXW

## CHARTS

### Free Space Radiation Pattern

SLPT2400/5900DMNW SLPT2400/5900DMN

#### Elevation Plane

#### Horizontal Plane

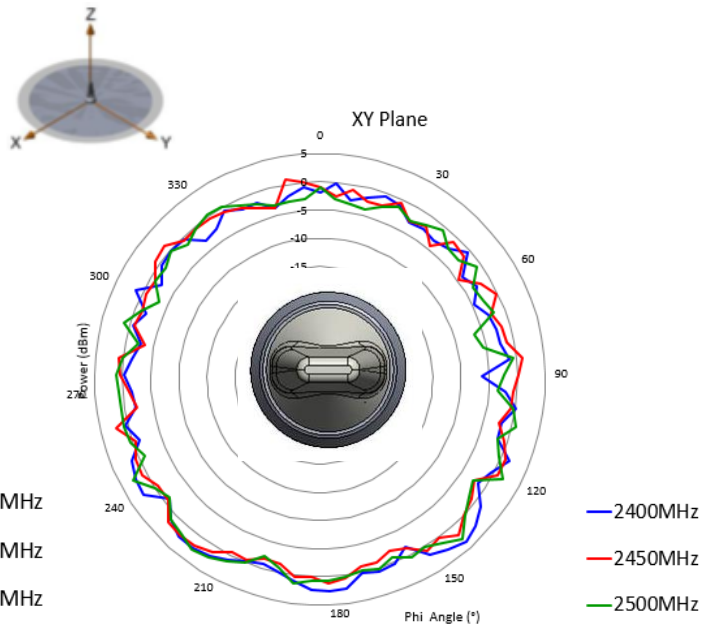
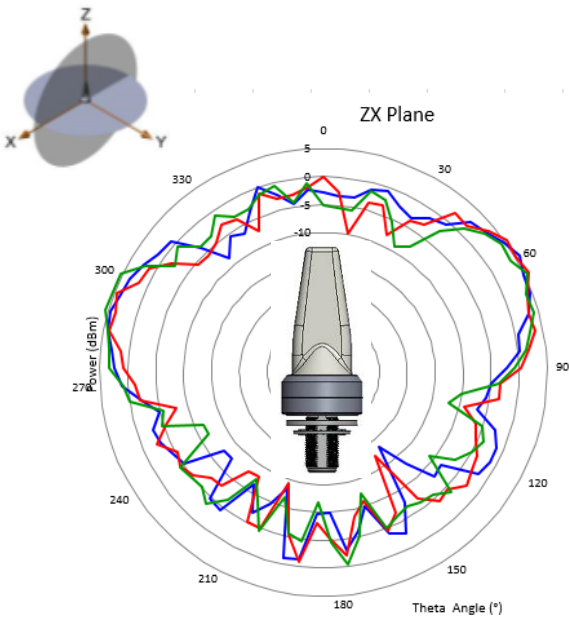

Issue: 1829

In the effort to improve our products, we reserve the right to make changes judged to be necessary.

CONFIDENTIAL AND PROPRIETARY INFORMATION

This document contains confidential and proprietary information of Pulse Electronics, Inc. (Pulse) and is protected by copyright, trade secret and other state and federal laws. Its receipt or possession does not convey any rights to reproduce, disclose its contents, or to manufacture, use or sell anything it may describe. Reproduction, disclosure or use without specific written authorization of Pulse is strictly forbidden.