

EFR32MG12 2.4 GHz/915 MHz Dual Band 19 dBm Radio Board BRD4164A Reference Manual



The BRD4164A Mighty Gecko Radio Board enables developers to develop Zigbee®, Thread, Bluetooth® low energy and proprietary wireless applications. The board contains a Mighty Gecko Wireless System on Chip 2.4 GHz and 915 MHz Dual Band and optimized for operation with 19 dBm output power. For the 2.4 GHz band with the on-board printed antenna and RF connector radiated and conducted testing is supported. For the 915 MHz band the on-board SMA connector enables conducted testing and attachment of external whip antenna for radiated tests.

The BRD4164A Mighty Gecko Radio Board plugs into the Wireless Starter Kit Main-board provided with the Mighty Gecko Starter Kit to get access to display, buttons and additional features from Expansion Boards. With the supporting Simplicity Studio suite of tools, developers can take advantage of graphical wireless application development; mesh networking debug and packet trace; and visual energy profiling and optimization. The board also serves as an RF reference design for applications targeting 2.4 GHz and 915 MHz Dual Band wireless operation with 19 dBm output power.

This document contains brief introduction and description of the BRD4164A Radio Board features focusing on the RF sections and performance.

RADIO BOARD FEATURES

- Wireless SoC:
EFR32MG12P433F1024GL125
- CPU core: ARM Cortex®-M4 with FPU
- Flash memory: 1024 kB
- RAM: 256 kB
- Operation frequency: 2.4 GHz + 915 MHz
- Transmit power: 19 dBm
- Integrated PCB antenna, UFL connector (optional).
- Touch Slider
- Crystals for LFXO and HFXO: 32.768 kHz and 38.4 MHz.

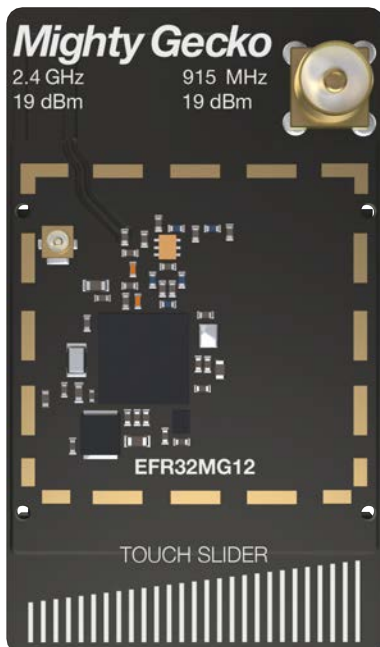

1. Introduction

The EFR32 Mighty Gecko Radio Boards provide a development platform (together with the Wireless Starter Kit Mainboard) for the Silicon Labs EFR32 Mighty Gecko Wireless System on Chips and serve as reference designs for the matching networks of the RF interfaces.

The BRD4164A Radio Board supports dual-band operation with its integrated sub-GHz ISM band and 2.4 GHz band transceivers. The sub-GHz section is designed to operate in the band with an external whip antenna, the 2.4 GHz section is designed to operate at the 2400-2483.5 MHz band with the on-board printed antenna. The matching networks are optimized to 19 dBm output power.

To develop and/or evaluate the EFR32 Mighty Gecko the BRD4164A Radio Board can be connected to the Wireless Starter Kit Mainboard to get access to display, buttons and additional features from Expansion Boards and also to evaluate the performance of the RF interfaces.

2. Radio Board Connector

2.1 Introduction

The board-to-board connector scheme allows access to all EFR32MG12 GPIO pins as well as the RESETn signal. For more information on the functions of the available pin functions, see the EFR32MG12 data sheet.

2.2 Radio Board Connector Pin Associations

The figure below shows the pin mapping on the connector to the radio pins and their function on the Wireless Starter Kit Mainboard.

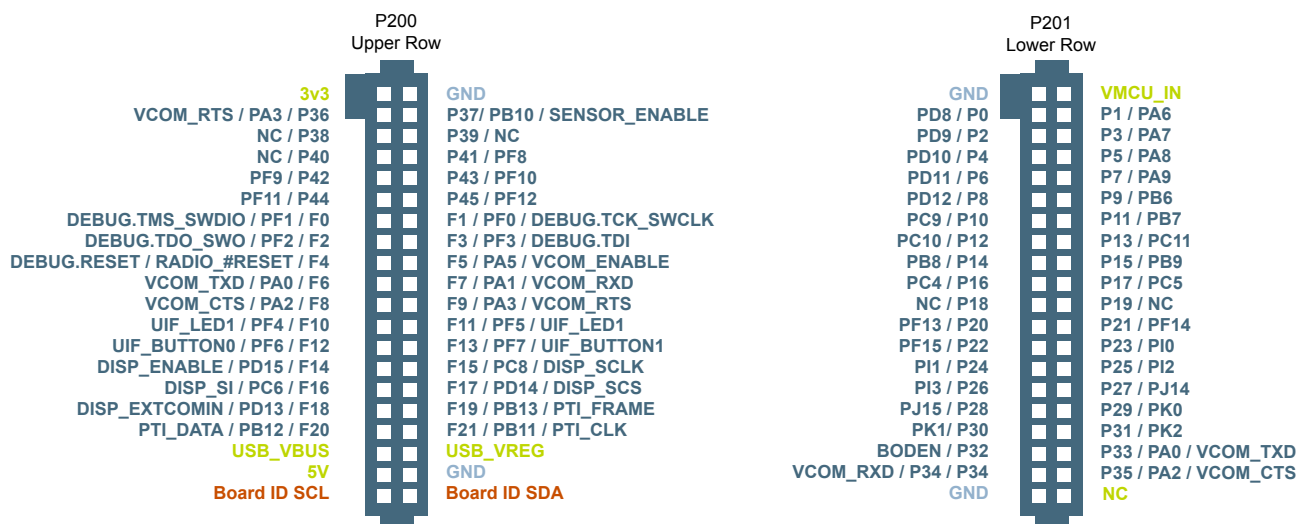

Figure 2.1. BRD4164A Radio Board Connector Pin Mapping

3. Radio Board Block Summary

3.1 Introduction

This section gives a short introduction to the blocks of the BRD4164A Radio Board.

3.2 Radio Board Block Diagram

The block diagram of the EFR32MG Radio Board is shown in the figure below.

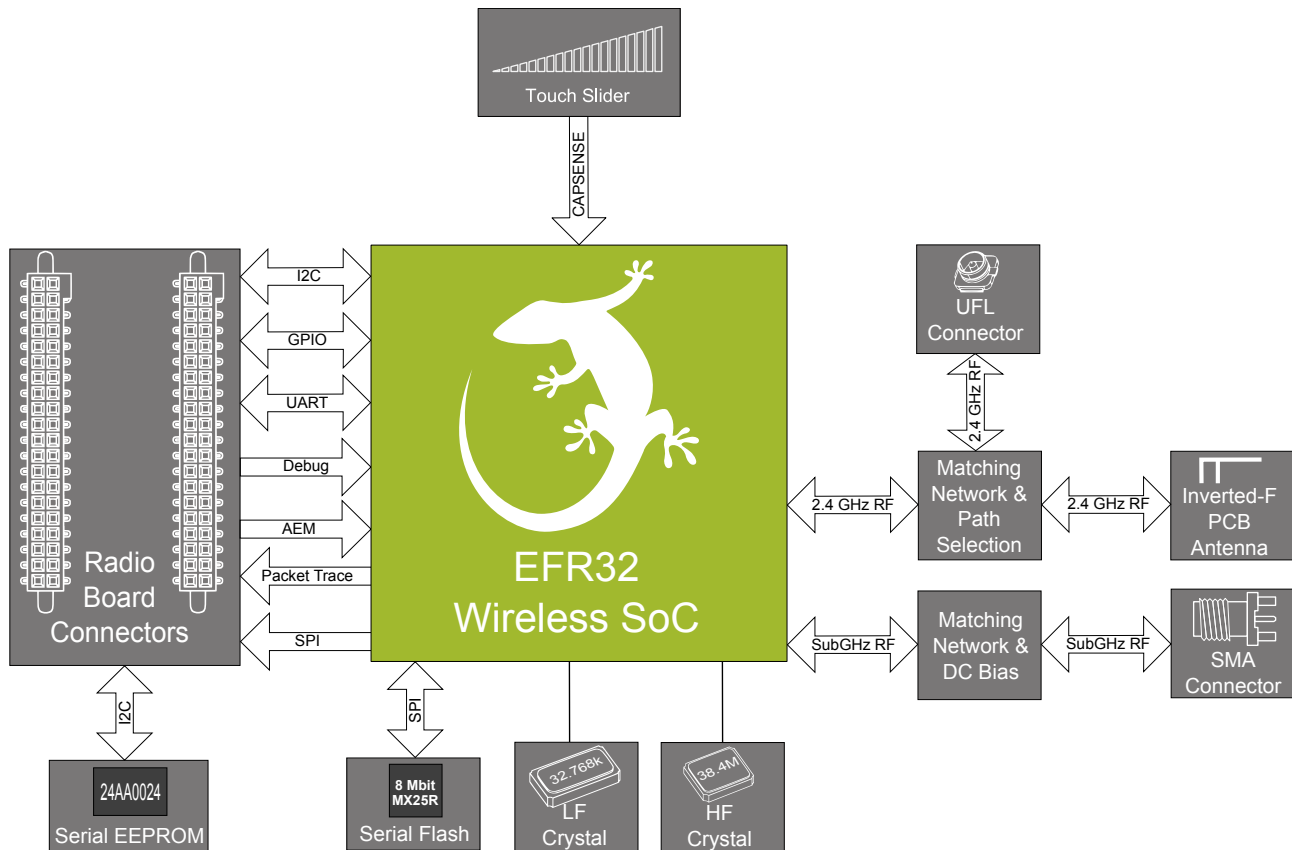

Figure 3.1. BRD4164A Block Diagram

3.3 Radio Board Block Description

3.3.1 Wireless MCU

The BRD4164A Mighty Gecko Radio Board incorporates an EFR32MG12P433F1024GL125 Wireless System on Chip featuring 32-bit Cortex[®]-M4 with FPU core, 1024 kB of flash memory 256 kB of RAM, an integrated 2.4 GHz band and an integrated sub-GHz ISM band transceiver with output power up to 19 dBm. For additional information on the EFR32MG12P433F1024GL125, refer to the EFR32MG12 Data Sheet.

3.3.2 LF Crystal Oscillator (LFXO)

The BRD4164A Radio Board has a 32.768 kHz crystal mounted.

3.3.3 HF Crystal Oscillator (HFXO)

The BRD4164A Radio Board has a 38.4 MHz crystal mounted.

3.3.4 Matching Network for Sub-GHz

The BRD4164A Radio Board incorporates a sub-GHz matching network which connects both the sub-GHz TX and RX pins of the EFR32MG12 to the one SMA connector to be able to transmit and receive with one antenna. The component values were optimized for the 915 MHz band RF performance and current consumption with 19 dBm output power.

For detailed description of the matching network see Chapter [4.2.1 Description of the Sub-GHz RF Matching](#).

3.3.5 Matching Network for 2.4 GHz

The BRD4164A Radio Board incorporates a 2.4 GHz matching network which connects the 2.4 GHz TRX pin of the EFR32MG12 to the one on-board printed Inverted-F antenna. The component values were optimized for the 2.4 GHz band RF performance and current consumption with 19 dBm output power.

For detailed description of the matching network see Chapter [4.2.2 Description of the 2.4 GHz RF Matching](#).

3.3.6 Inverted-F Antenna

The BRD4164A Radio Board includes a printed Inverted-F antenna (IFA) tuned to have close to 50 Ohm impedance at the 2.4 GHz band.

For detailed description of the antenna see Chapter [4.6 Inverted-F Antenna](#).

3.3.7 SMA connector

To be able to perform conducted measurements or mount external antenna for radiated measurements, range tests etc., Silicon Labs added an SMA connector to the Radio Board. The connector allows an external 50 Ohm cable or antenna to be connected during design verification or testing.

3.3.8 UFL Connector

To be able to perform conducted measurements Silicon Labs added an UFL connector to the Radio Board. The connector allows an external 50 Ohm cable or antenna to be connected during design verification or testing.

Note: By default the output of the matching network is connected to the printed Inverted-F antenna by a series component. It can be connected to the UFL connector as well through a series 0 Ohm resistor which is not mounted by default. For conducted measurements through the UFL connector the series component to the antenna should be removed and the 0 Ohm resistor should be mounted (see Chapter [4.2 Schematic of the RF Matching Network](#) for further details).

3.3.9 Radio Board Connectors

Two dual-row, 0.05" pitch polarized connectors make up the EFR32MG Radio Board interface to the Wireless Starter Kit Mainboard.

For more information on the pin mapping between the EFR32MG12P433F1024GL125 and the Radio Board Connector, refer to Chapter [2.2 Radio Board Connector Pin Associations](#).

3.3.10 Capacitive Touch Slider

The touch slider (T2) utilizes the capacitive touch capability of the Capacitance Sense Module of the EFR32MG12. The slider interpolates 4 separate pads to find the exact position of a finger.

The figure below shows the pin mapping of the touch slider to the Wireless SoC.

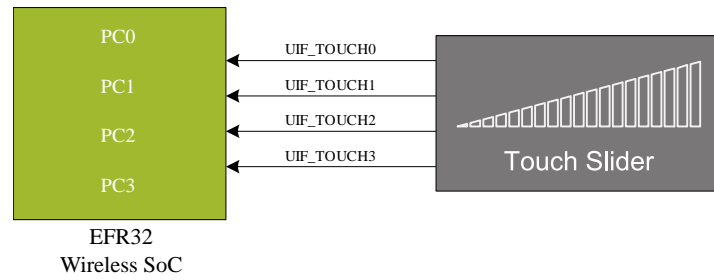

Figure 3.2. Touch Slider Pin Mapping

4. RF Section

4.1 Introduction

This section gives a short introduction to the RF section of the BRD4164A.

4.2 Schematic of the RF Matching Network

The schematic of the RF section of the BRD4164A Radio Board is shown in the following figure.

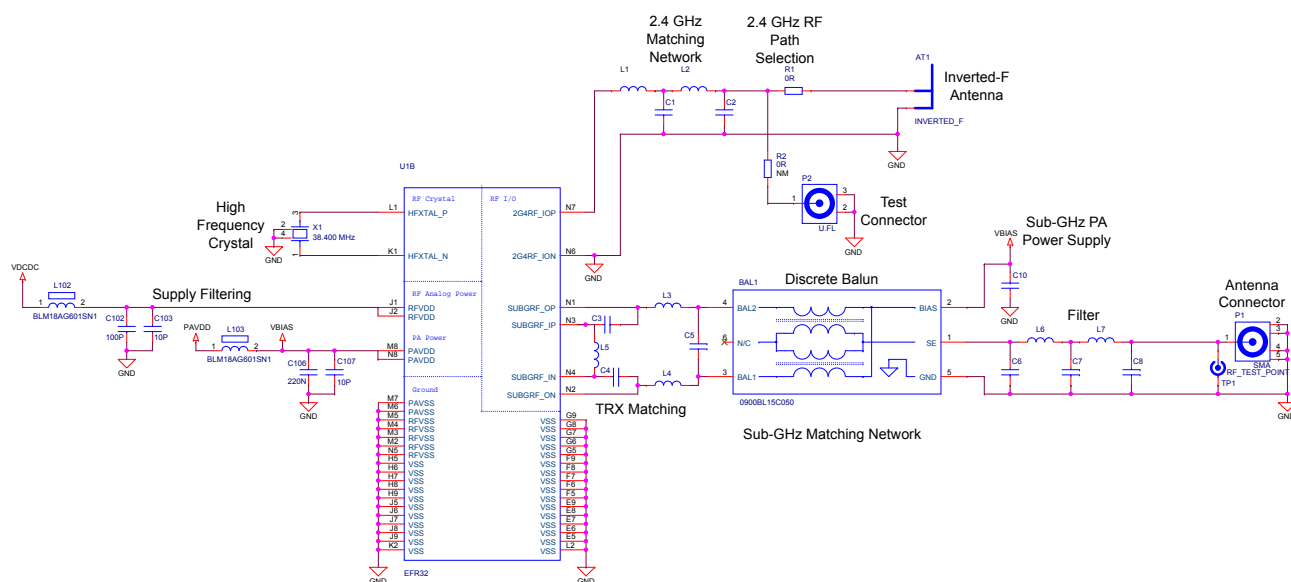

Figure 4.1. Schematic of the RF Section of the BRD4164A

4.2.1 Description of the Sub-GHz RF Matching

The sub-GHz matching network connects the differential TX outputs and RX inputs of the sub-GHz RF port to the SMA connector while transforming the impedances to 50 Ohm. Careful design procedure was followed to ensure that the RX input circuitry does not load down the TX output path while in TX mode and that the TX output circuitry does not degrade receive performance while in RX mode.

The matching includes a differential impedance matching circuitry, a discrete balanced-unbalanced transformer and a filter section. The targeted output power is 19 dBm at 915 MHz.

4.2.2 Description of the 2.4 GHz RF Matching

The 2.4 GHz matching connects the 2G4RF_IOP pin to the on-board printed Inverted-F Antenna. The 2G4RF_ION pin is connected to ground. For higher output powers (13 dBm and above) beside the impedance matching circuitry it is recommended to use additional harmonic filtering as well at the RF output. The targeted output power of the BRD4164A board is 19 dBm thus the RF output of the IC is connected to the antenna through a four-element impedance matching and harmonic filter circuitry.

For conducted measurements the output of the matching network can also be connected to the UFL connector by relocating the series R1 resistor to the R2 resistor position between the output of the matching and the UFL connector.

4.3 RF Section Power Supply

On the BRD4164A Radio Board the supply pin of the radio (RFVDD) is connected directly to the output of the on-chip DC-DC converter while the supply for the sub-GHz and 2.4 GHz power amplifiers (SUBGRF_ON, SUBGRF_OP and PAVDD pins) is provided directly by the Motherboard. This way, by default, the DC-DC converter provides 1.8 V for the RF analog section, the Motherboard provides 3.3 V for the PAs (for details, see the schematic of the BRD4164A).

4.4 Bill of Materials for the sub-GHz Matching

The Bill of Materials of the sub-GHz matching network of the BRD4164A Radio Board is shown in the following table.

Table 4.1. Bill of Materials for the BRD4164A Sub-GHz RF Matching Network

Component name	Value	Manufacturer	Part Number
L3	3.3 nH	Murata	LQW15AN3N3B80D
L4	3.3 nH	Murata	LQW15AN3N3B80D
L5	18 nH	Murata	LQW15AN18NG00D
L6	10 nH	Murata	LQW15AN10NJ00D
L7	10 nH	Murata	LQW15AN10NJ00D
C3	1.8 pF	Murata	GRM1555C1H1R8WA01D
C4	1.8 pF	Murata	GRM1555C1H1R8WA01D
C5	3.9 pF	Murata	GRM1555C1H3R9WA01D
C6	3.3 pF	Murata	GRM1555C1H3R3BA01D
C7	5.6 pF	Murata	GRM1555C1H5R6BA01D
C8	3.3 pF	Murata	GRM1555C1H3R3BA01D
C10	56 pF	Murata	GRM1555C1H560GA01D

4.5 Bill of Materials for the 2.4 GHz Matching

The Bill of Materials of the 2.4 GHz matching network of the BRD4164A Radio Board is shown in the following table.

Table 4.2. Bill of Materials for the BRD4164A 2.4GHz RF Matching Network

Component name	Value	Manufacturer	Part Number
L1	1.8 nH	Murata	LQP15MN1N8W02D
L2	3.0 nH	Murata	LQP15MN3N0W02D
C1	2.0 pF	Murata	GRM1555C1H2R0WA01D
C2	1.0 pF	Murata	GRM1555C1H1R0WA01D

4.6 Inverted-F Antenna

The BRD4164A Radio Board includes an on-board printed Inverted-F Antenna tuned for the 2.4 GHz band. Due to the design restrictions of the Radio Board the input of the antenna and the output of the matching network can't be placed directly next to each other. Therefore, a 50 Ohm transmission line was necessary to connect them. The resulting impedance and reflection measured at the output of the matching network are shown in the following figure. As it can be observed the impedance is close to 50 Ohm (the reflection is around or better than -10 dB) for the entire 2.4 GHz band.

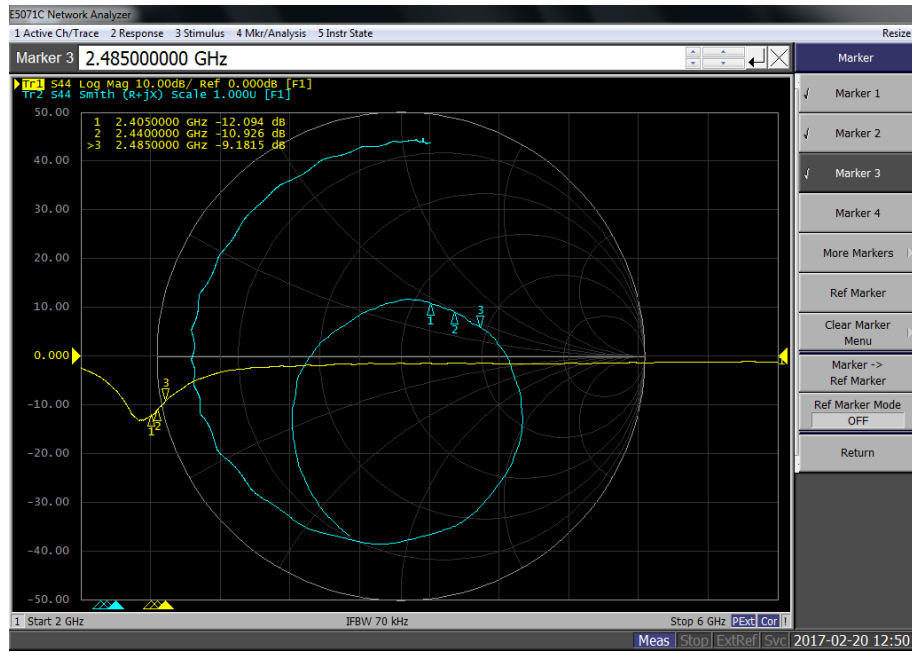

Figure 4.2. Impedance and Reflection of the Inverted-F Antenna of the BRD4164A Board Measured from the Matching Output

5. Mechanical Details

The BRD4164A Mighty Gecko Radio Board is illustrated in the figures below.

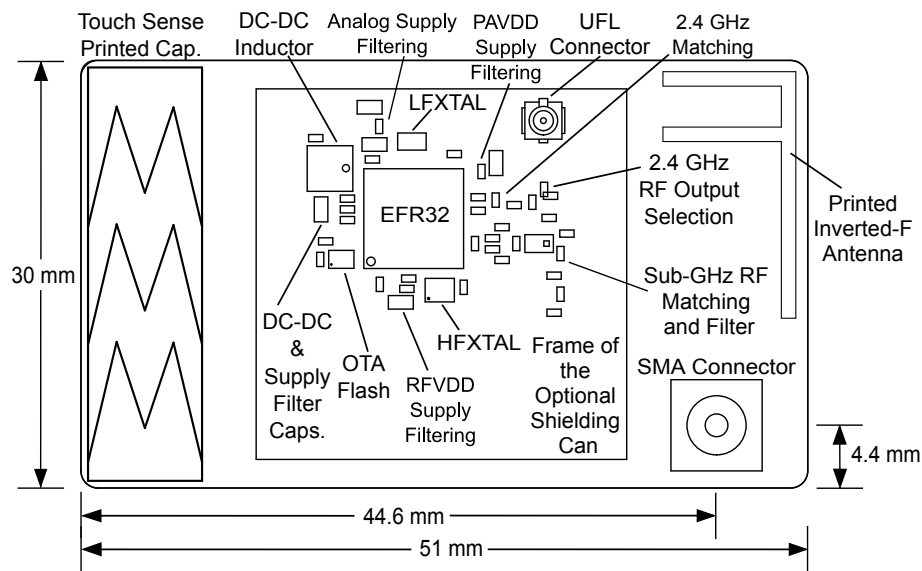

Figure 5.1. BRD4164A Top View

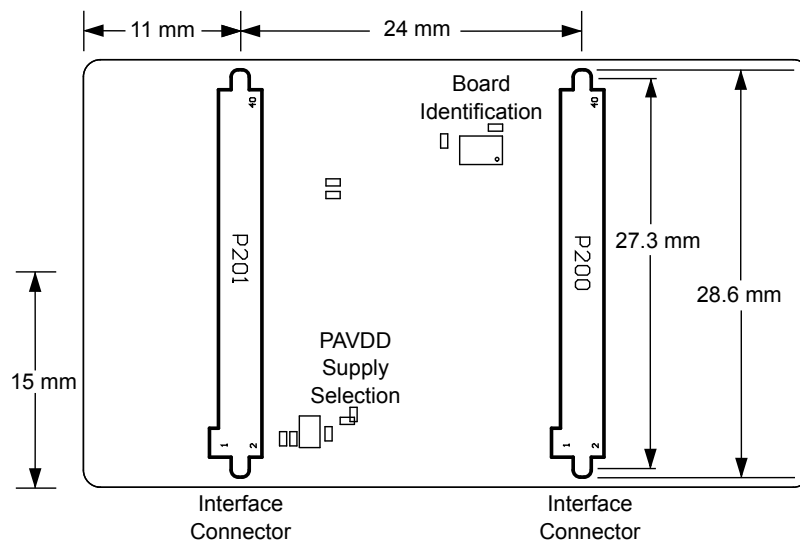

Figure 5.2. BRD4164A Bottom View

6. EMC Compliance

6.1 Introduction

Compliance of the fundamental and harmonic levels is tested at the listed frequencies against the listed EMC regulations:

- 915 MHz:
 - FCC 15.247
- 2.4 GHz:
 - ETSI EN 300-328
 - FCC 15.247

6.2 EMC Regulations for 915 MHz

6.2.1 FCC15.247 Emission Limits for the 902-928 MHz Band

FCC 15.247 allows conducted output power up to 1 Watt (30 dBm) in the 902-928 MHz band. For spurious emissions the limit is -20 dBc based on either conducted or radiated measurement, if the emission is not in a restricted band. The restricted bands are specified in FCC 15.205. In these bands the spurious emission levels must meet the levels set out in FCC 15.209. In the range from 960 MHz to the frequency of the 10th harmonic it is defined as 0.5 mV/m at 3 m distance (equals to -41.2 dBm in EIRP).

In case of operating in the 902-928 MHz band from the first 10 harmonics only the 2nd and 7th harmonics don't fall into restricted bands so for those the -20 dBc limit should be applied. For the rest of the harmonics the -41.2 dBm limit should be applied.

6.3 EMC Regulations for 2.4 GHz

6.3.1 ETSI EN 300-328 Emission Limits for the 2400-2483.5 MHz Band

Based on ETSI EN 300-328 the allowed maximum fundamental power for the 2400-2483.5 MHz band is 20 dBm EIRP. For the unwanted emissions in the 1 GHz to 12.75 GHz domain the specified limit is -30 dBm EIRP.

6.3.2 FCC15.247 Emission Limits for the 2400-2483.5 MHz Band

FCC 15.247 allows conducted output power up to 1 Watt (30 dBm) in the 2400-2483.5 MHz band. For spurious emissions the limit is -20 dBc based on either conducted or radiated measurement, if the emission is not in a restricted band. The restricted bands are specified in FCC 15.205. In these bands the spurious emission levels must meet the levels set out in FCC 15.209. In the range from 960 MHz to the frequency of the 5th harmonic it is defined as 0.5 mV/m at 3 m distance (equals to -41.2 dBm in EIRP).

Additionally, for spurious frequencies above 1 GHz, FCC 15.35 allows duty-cycle relaxation to the regulatory limits. For the EmberZNet PRO the relaxation is 3.6 dB. Therefore, the -41.2 dBm limit can be modified to -37.6 dBm.

If operating in the 2400-2483.5 MHz band the 2nd, 3rd and 5th harmonics can fall into restricted bands. As a result, for those the -37.6 dBm limit should be applied. For the 4th harmonic the -20 dBc limit should be applied.

6.3.3 Applied Emission Limits for the 2.4 GHz Band

The above ETSI limits are applied both for conducted and radiated measurements.

The FCC restricted band limits are radiated limits only. Besides that, Silicon Labs applies those to the conducted spectrum i.e., it is assumed that, in case of a custom board, an antenna is used which has 0 dB gain at the fundamental and the harmonic frequencies. In that theoretical case, based on the conducted measurement, the compliance with the radiated limits can be estimated.

The overall applied limits are shown in the table below.

Table 6.1. Applied Limits for Spurious Emissions for the 2.4 GHz Band

Harmonic	Frequency	Limit
2nd	4800~4967 MHz	-37.6 dBm
3rd	7200~7450.5 MHz	-37.6 dBm
4th	9600~9934 MHz	-30 dBm
5th	12000~12417.5 MHz	-37.6 dBm

7. RF Performance

7.1 Conducted Power Measurements

During measurements, the EFR32MG Radio Board was attached to a Wireless Starter Kit Mainboard which was supplied by USB. The voltage supply for the Radio Board was 3.3 V.

7.1.1 Conducted Measurements in the 915 MHz band

The EFR32MG Radio Board was connected directly to a Spectrum Analyzer through its SMA connector. The supply for the radio (RFVDD) was 1.8 V provided by the on-chip DC-DC converter, the supply for the sub-GHz power amplifier (SUBGRF_ON, SUBGRF_OP) was 3.3 V provided by the Motherboard (VBIAS through the discrete balun; for details, see the schematic of the BRD4164A). The transceiver was operated in continuous carrier transmission mode. The output power of the radio was set to 19 dBm.

The typical output spectrum is shown in the following figure.

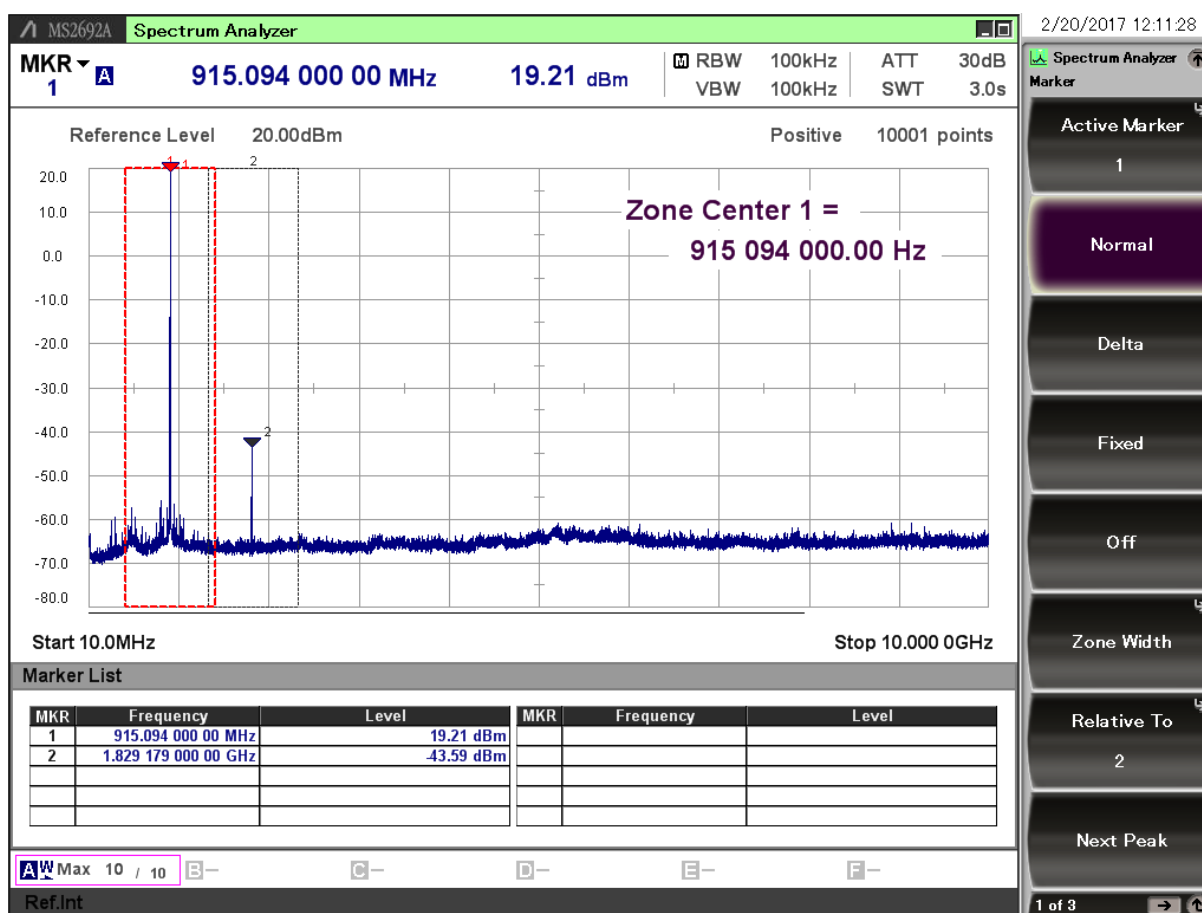

Figure 7.1. Typical Output Spectrum of the BRD4164A

As it can be observed the fundamental is close to 19 dBm so it is compliant with the 30 dBm fundamental limit, the strongest unwanted emission is the double-frequency harmonic but with only around -43.6 dBm level it is compliant with the corresponding limit (-20 dBc) with large margin. The other unwanted emissions are under -50 dBm. So the conducted spectrum is compliant with the regulation limits.

7.1.2 Conducted Measurements in the 2.4 GHz band

The EFR32MG Radio Board board was connected directly to a Spectrum Analyzer through its UFL connector (the 0 Ohm resistor was removed from the R1 position and was soldered to the R2 position). The supply for the radio (RFVDD) was 1.8 V provided by the on-chip DC-DC converter, the supply for the 2.4 GHz power amplifier (PAVDD) was 3.3 V provided by the Motherboard (for details, see the schematic of the BRD4164A). The transceiver was operated in continuous carrier transmission mode. The output power of the radio was set to 19 dBm.

The typical output spectrum is shown in the following figure.

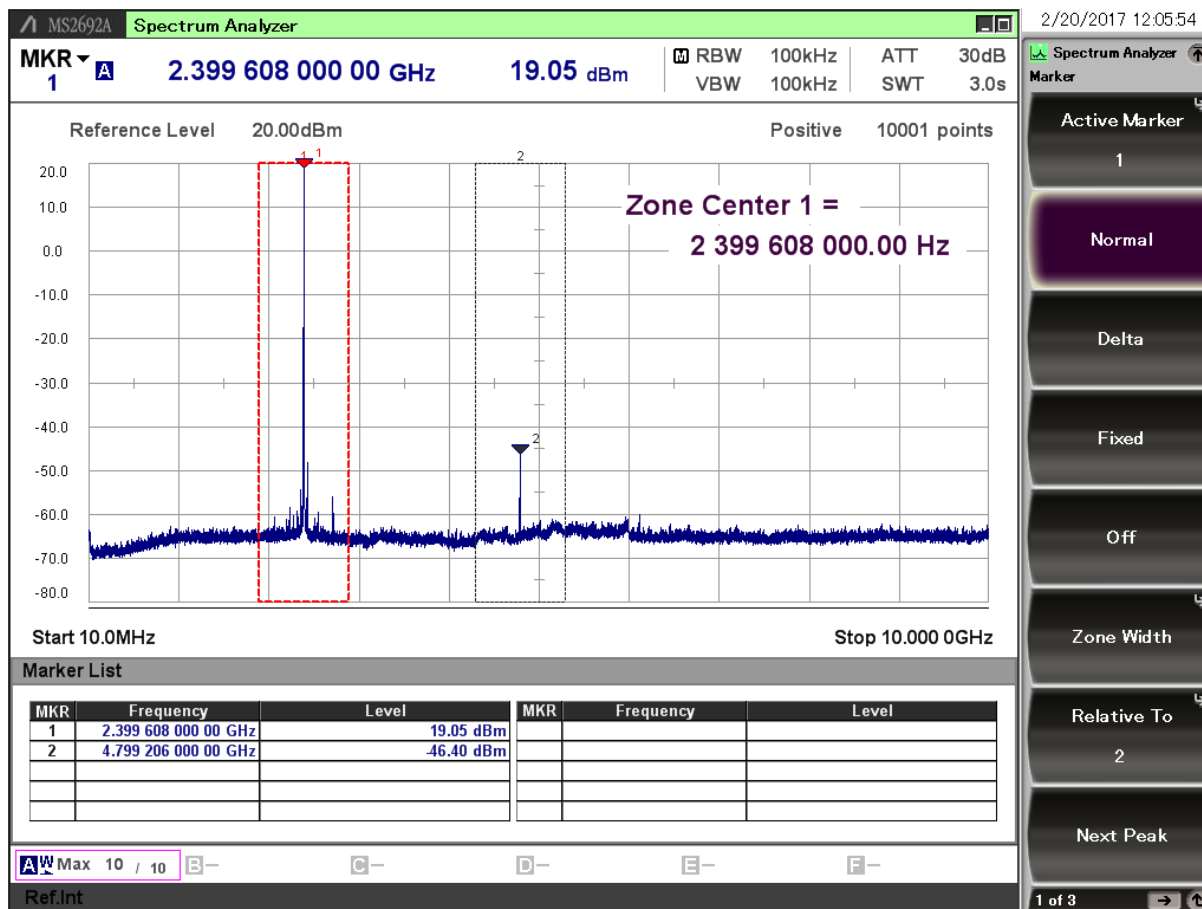

Figure 7.2. Typical Output Spectrum of the BRD4164A

As it can be observed the fundamental is slightly lower than 19 dBm limit and the strongest unwanted emission is the double-frequency harmonic but with its -46.4 dBm level it is under the -37.6 dBm applied limit with ~11 dB margin. So the conducted spectrum is compliant with the applied limits.

Note: The conducted measurement is performed by connecting the on-board UFL connector to a Spectrum Analyzer through an SMA Conversion Adapter (P/N: HRMJ-U.FLP(40)). This connection itself introduces approx. 0.3 dB insertion loss.

7.2 Radiated Power Measurements

During measurements, the EFR32MG Radio Board was attached to a Wireless Starter Kit Mainboard which was supplied by USB. The voltage supply for the Radio Board was 3.3 V. The radiated power was measured in an antenna chamber by rotating the DUT 360 degrees with horizontal and vertical reference antenna polarizations in the XY, XZ and YZ cuts. The measurement axes are shown in the figure below.

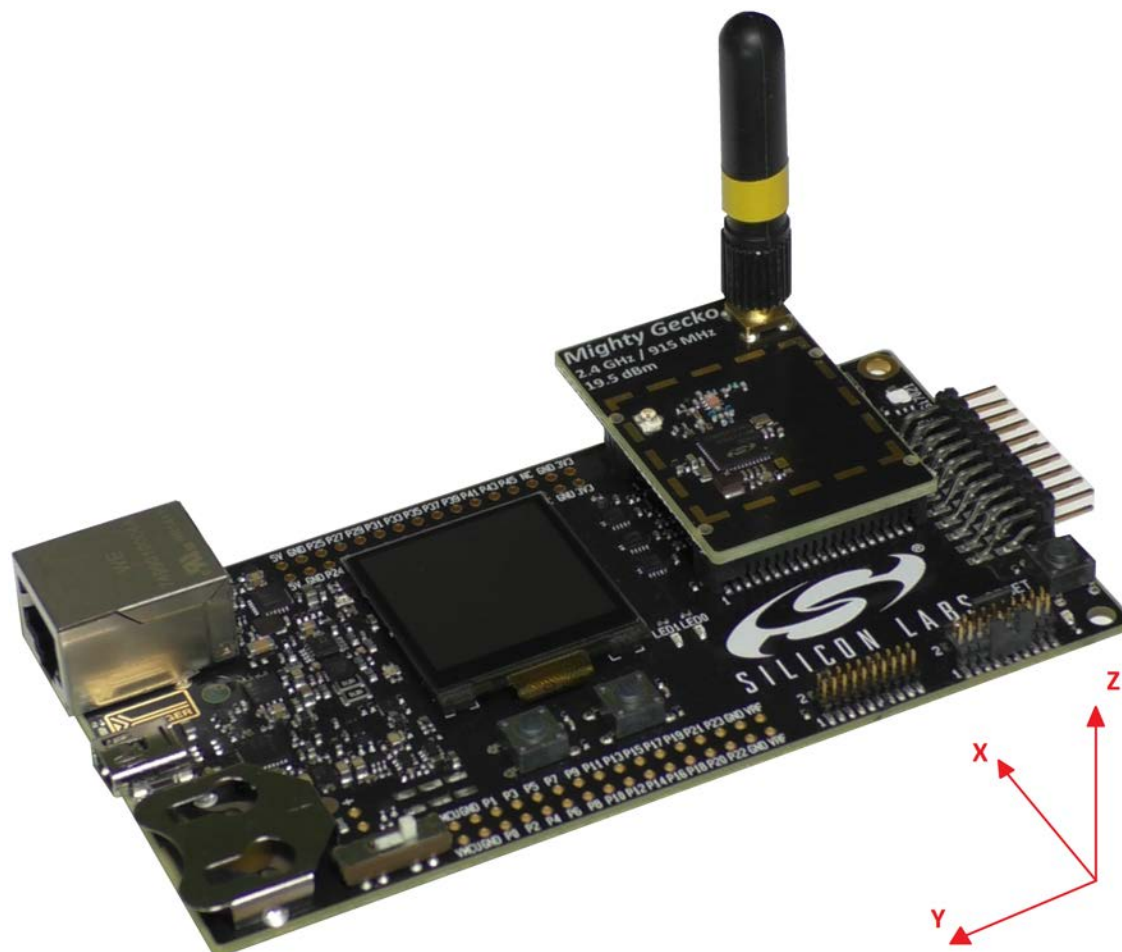

Figure 7.3. DUT: Radio Board with the Wireless Starter Kit Mainboard (Illustration)

Note: The radiated measurement results presented in this document were recorded in an unlicensed antenna chamber. Also the radiated power levels may change depending on the actual application (PCB size, used antenna, and so on). Therefore, the absolute levels and margins of the final application are recommended to be verified in a licensed EMC testhouse.

7.2.1 Radiated Measurements in the 915 MHz band

For the 915 MHz radiated power measurements an external whip antenna (P/N: ANT-915-CW-HWR-SMA) was used as a transmitter antenna. It was connected to the SMA connector of the EFR32MG Radio Board. The supply for the radio (RFVDD) was 1.8 V provided by the on-chip DC-DC converter, the supply for the sub-GHz power amplifier (SUBGRF_ON, SUBGRF_OP) was 3.3 V provided by the Motherboard (VBIAS through the discrete balun; for details, see the schematic of the BRD4164A). The transceiver was operated in continuous carrier transmission mode. The output power of the radio was set to 19 dBm.

The measured radiated powers are shown in the table below.

Table 7.1. Maximums of the measured radiated powers in EIRP [dBm]

Frequency	EIRP [dBm]	Orientation	Margin [dB]	Limit in EIRP [dBm]
Fund	21.4	YZ/H	8.6	30
2nd	-32.1	YZ/H	33.5	-20 dBc
3rd	-42.9	XY/V	1.7	-41.2
4th	-47	YZ/V	5.8	-41.2
5th	<-50*	-/-	>10	-41.2
6th	-47.7	XZ/H	6.5	-41.2
7th	<-50*	-/-	>10	-20 dBc
8th	<-50*	-/-	>10	-41.2
9th	<-50*	-/-	>10	-41.2
10th	<-50*	-/-	>10	-41.2

* Signal level is below the Spectrum Analyzer noise floor.

As it can be observed the fundamental is below the regulation limit by more than 8 dB, the harmonic levels are also compliant.

7.2.2 Radiated Measurements in the 2.4 GHz band

For the 2.4 GHz radiated power measurements the on-board printed Inverted-F antenna of the EFR32MG Radio Board was used (the R1 resistor was mounted). The supply for the radio (RFVDD) was 1.8 V provided by the on-chip DC-DC converter, the supply for the 2.4 GHz power amplifier (PAVDD) was 3.3 V provided by the Motherboard (for details, see the schematic of the BRD4164A). The transceiver was operated in continuous carrier transmission mode. The output power of the radio was set to 19 dBm. During the measurement the sub-GHz antenna (P/N: ANT-915-CW-HWR-SMA) was attached to the SMA connector.

The results are shown in the table below.

Table 7.2. Maximums of the measured radiated powers in EIRP [dBm]

Frequency	EIRP [dBm]	Orientation	Margin [dB]	Limit in EIRP [dBm]
Fund	22	XY/H	-22	30
2nd	-44.9	XZ/H	7.3	-37.6
3rd	-52.3	XZ/H	14.7	-37.6
4th	-45.7	XZ/V	15.7	-30
5th	<-50*	-/-	>10	-37.6

* Signal level is below the Spectrum Analyzer noise floor.

As it can be observed, thanks to the high gain of the Inverted-F antenna, the level of the fundamental is higher than 19 dBm. The strongest harmonic is the double-frequency one and it is compliant with the applied limit with ~7 dB margin.

8. EMC Compliance Recommendations

8.1 Recommendations for 915 MHz FCC 15.247 compliance

As it was shown in the previous chapter the BRD4164A Mighty Gecko Radio Board is compliant with the emission limits of the FCC 15.247 regulation with 19 dBm output power. Although the BRD4164A Radio Board has an option for mounting a shielding can, that is not required for the compliance.

8.2 Recommendations for 2.4 GHz ETSI EN 300-328 compliance

As it was shown in the previous chapter the radiated power of the fundamental of the BRD4164A Mighty Gecko Radio Board with 19 dBm output power exceeds the 20 dBm limit of the ETSI EN 300-328 regulation due to the high antenna gain so reduction of the fundamental power is required by approx. 2 dB in order to comply. The harmonic emissions are under the -30 dBm limit with large margin even with 19 dBm output power. Although the BRD4164A Radio Board has an option for mounting a shielding can, that is not required for the compliance.

8.3 Recommendations for 2.4 GHz FCC 15.247 compliance

As it was shown in the previous chapter the BRD4164A Mighty Gecko Radio Board is compliant with the emission limits of the FCC 15.247 regulation with 19 dBm output power. Although the BRD4164A Radio Board has an option for mounting a shielding can, that is not required for the compliance.

9. Document Revision History

Table 9.1. Document Revision History

Revision Number	Effective Date	Change Description
1.00	28.2.2017	Initial release.

10. Board Revision History

Table 10.1. BRD4164A Radio Board Revisions

Radio Board Revision	Description
A03	Fixing EFR32 pin names; Updated PCB revision.
A02	Updated EFR32 chip revision and 32 kHz crystal part number.
A01	Fixing EFR part number.
A00	Initial version.

11. Errata

There are no known errata at present.

Table of Contents

1. Introduction	1
2. Radio Board Connector	2
2.1 Introduction	2
2.2 Radio Board Connector Pin Associations	2
3. Radio Board Block Summary	3
3.1 Introduction	3
3.2 Radio Board Block Diagram	3
3.3 Radio Board Block Description	3
3.3.1 Wireless MCU	3
3.3.2 LF Crystal Oscillator (LFXO)	3
3.3.3 HF Crystal Oscillator (HFXO)	3
3.3.4 Matching Network for Sub-GHz	4
3.3.5 Matching Network for 2.4 GHz	4
3.3.6 Inverted-F Antenna	4
3.3.7 SMA connector	4
3.3.8 UFL Connector	4
3.3.9 Radio Board Connectors	4
3.3.10 Capacitive Touch Slider	5
4. RF Section	6
4.1 Introduction	6
4.2 Schematic of the RF Matching Network	6
4.2.1 Description of the Sub-GHz RF Matching	6
4.2.2 Description of the 2.4 GHz RF Matching	6
4.3 RF Section Power Supply	6
4.4 Bill of Materials for the sub-GHz Matching	6
4.5 Bill of Materials for the 2.4 GHz Matching	7
4.6 Inverted-F Antenna	7
5. Mechanical Details	9
6. EMC Compliance	10
6.1 Introduction	10
6.2 EMC Regulations for 915 MHz	10
6.2.1 FCC15.247 Emission Limits for the 902-928 MHz Band	10
6.3 EMC Regulations for 2.4 GHz	10
6.3.1 ETSI EN 300-328 Emission Limits for the 2400-2483.5 MHz Band	10
6.3.2 FCC15.247 Emission Limits for the 2400-2483.5 MHz Band	10
6.3.3 Applied Emission Limits for the 2.4 GHz Band	11
7. RF Performance	12
7.1 Conducted Power Measurements	12

7.1.1	Conducted Measurements in the 915 MHz band	.12
7.1.2	Conducted Measurements in the 2.4 GHz band	.13
7.2	Radiated Power Measurements	.14
7.2.1	Radiated Measurements in the 915 MHz band	.15
7.2.2	Radiated Measurements in the 2.4 GHz band	.15
8.	EMC Compliance Recommendations	16
8.1	Recommendations for 915 MHz FCC 15.247 compliance	.16
8.2	Recommendations for 2.4 GHz ETSI EN 300-328 compliance	.16
8.3	Recommendations for 2.4 GHz FCC 15.247 compliance	.16
9.	Document Revision History	17
10.	Board Revision History	18
11.	Errata	19
	Table of Contents	20