

# SANMOTION

## 2-PHASE STEPPING SYSTEMS

# F2

### 56 mm sq. 2-Phase Stepping Motors

DC Input

UL<sup>®</sup> US



Flange size: 56 mm

Motor length (motor only): 41.8, 53.8, 75.8, 85.8 mm

Unipolar winding / Bipolar winding

Single shaft / Dual shaft

Stepping motors / Geared / With electromagnetic brake / With encoder

#### High torque

Compared to our conventional model, torque performance has improved by approximately 40%.\*  
This contributes to shortening the positioning time and machine cycle time.

#### Low noise

These motors have noise levels approximately 3 dB lower than the current model, reducing the noise level of machines.\*

#### Energy-saving

Motor efficiency has been improved by approximately 3% compared to the current model.\*  
This contributes to reducing power consumption of machines and the motor's heat dissipation.

\* A comparison between our current model 103H7123-5840 and new model SM2562C30B41.



# SANYO DENKI

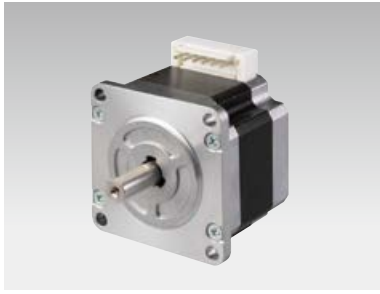

# 56 mm sq.

1.8°/step RoHS

Unipolar winding, connector type



Lineup → p. 7

Low-backlash gear model

Harmonic gear model

Electromagnetic brake model

Encoder model

## Unipolar winding, connector type

Model no.		Holding torque at 2-phase excitation N·m min.	Rated current A/phase	Wiring resistance Ω/phase	Winding inductance mH/phase	Rotor inertia ×10 <sup>-4</sup> kg·m <sup>2</sup>	Mass kg	Motor length (L) mm
Single shaft	Dual shaft							
SM2561C10U41	SM2561C10U11	0.53	1	4.3	6.8	0.14	0.49	41.8
SM2561C20U41	SM2561C20U11	0.53	2	1.15	1.8	0.14	0.49	41.8
SM2561C30U41	SM2561C30U11	0.53	3	0.52	0.77	0.14	0.49	41.8
SM2562C10U41	SM2562C10U11	1.1	1	5.85	12.6	0.28	0.69	53.8
SM2562C20U41	SM2562C20U11	1.1	2	1.55	3.3	0.28	0.69	53.8
SM2562C30U41	SM2562C30U11	1.1	3	0.69	1.37	0.28	0.69	53.8
SM2563C10U41	SM2563C10U11	1.7	1	7.8	17	0.5	1.1	75.8
SM2563C20U41	SM2563C20U11	1.7	2	1.87	4.2	0.5	1.1	75.8
SM2563C30U41	SM2563C30U11	1.7	3	0.74	1.75	0.5	1.1	75.8
SM2564C10U41	SM2564C10U11	1.75	1	9	22	0.6	1.27	85.8
SM2564C20U41	SM2564C20U11	1.75	2	2.1	5.4	0.6	1.27	85.8
SM2564C30U41	SM2564C30U11	1.75	3	0.84	2.2	0.6	1.27	85.8

Motor cable: model no. 4837798-1

## Characteristics diagram

### SM2561C10U41 SM2561C10U11

Constant current circuit  
Source voltage: 24 VDC  
Operating current:  
1 A/phase, 2-phase  
excitation (full-step)  
Pull-out torque:  
 $J_L=0.94 \times 10^{-4}$ kg·m<sup>2</sup> (with  
rubber coupling)  
fs: Maximum self-start  
frequency when not  
loaded

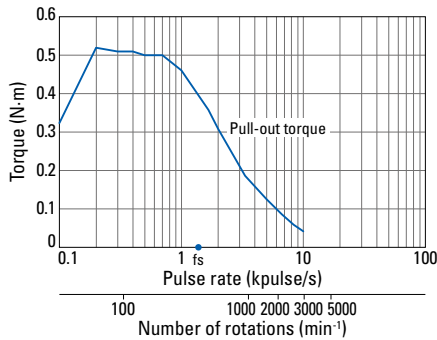

### SM2561C20U41 SM2561C20U11

Constant current circuit  
Source voltage: 24 VDC  
Operating current:  
2 A/phase, 2-phase  
excitation (full-step)  
Pull-out torque:  
 $J_L=0.94 \times 10^{-4}$ kg·m<sup>2</sup> (with  
rubber coupling)  
fs: Maximum self-start  
frequency when not  
loaded

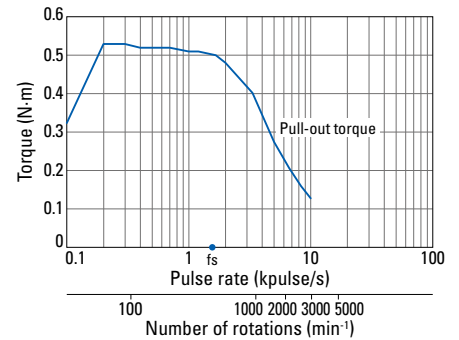

### SM2561C30U41 SM2561C30U11

Constant current circuit  
Source voltage: 24 VDC  
Operating current:  
3 A/phase, 2-phase  
excitation (full-step)  
Pull-out torque:  
 $J_L=0.94 \times 10^{-4}$ kg·m<sup>2</sup> (with  
rubber coupling)  
fs: Maximum self-start  
frequency when not  
loaded

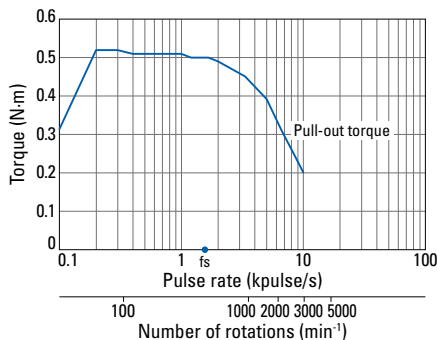

### SM2562C10U41 SM2562C10U11

Constant current circuit  
Source voltage: 24 VDC  
Operating current:  
1 A/phase, 2-phase  
excitation (full-step)  
Pull-out torque:  
 $J_L=2.6 \times 10^{-4}$ kg·m<sup>2</sup> (with  
rubber coupling)  
fs: Maximum self-start  
frequency when not  
loaded

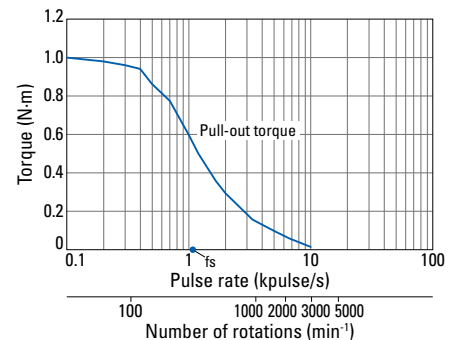

### SM2562C20U41 SM2562C20U11

Constant current circuit  
Source voltage: 24 VDC  
Operating current:  
2 A/phase, 2-phase  
excitation (full-step)  
Pull-out torque:  
 $J_L=2.6 \times 10^{-4}$ kg·m<sup>2</sup> (with  
rubber coupling)  
fs: Maximum self-start  
frequency when not  
loaded

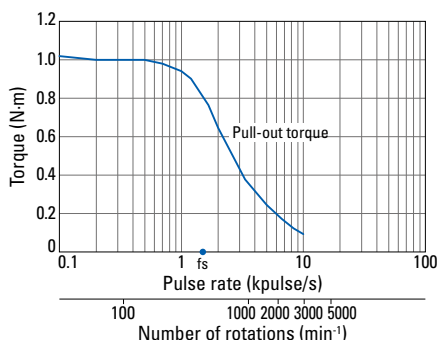

### SM2562C30U41 SM2562C30U11

Constant current circuit  
Source voltage: 24 VDC  
Operating current:  
3 A/phase, 2-phase  
excitation (full-step)  
Pull-out torque:  
 $J_L=2.6 \times 10^{-4}$ kg·m<sup>2</sup> (with  
rubber coupling)  
fs: Maximum self-start  
frequency when not  
loaded

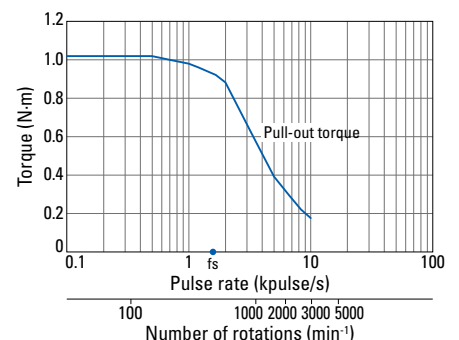

## Characteristics diagram

### SM2563C10U41 SM2563C10U11

Constant current circuit  
Source voltage: 24 VDC  
Operating current:  
1 A/phase, 2-phase  
excitation (full-step)  
Pull-out torque:  
 $J_L=7.4 \times 10^{-4} \text{kg}\cdot\text{m}^2$  (with  
rubber coupling)  
fs: Maximum self-start  
frequency when not  
loaded

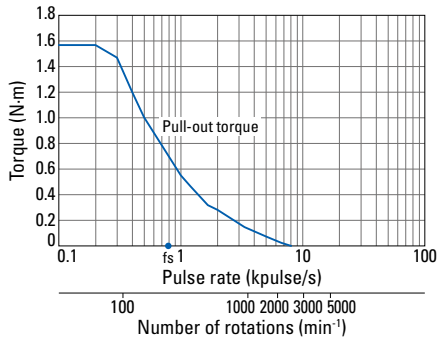

### SM2563C20U41 SM2563C20U11

Constant current circuit  
Source voltage: 24 VDC  
Operating current:  
2 A/phase, 2-phase  
excitation (full-step)  
Pull-out torque:  
 $J_L=7.4 \times 10^{-4} \text{kg}\cdot\text{m}^2$  (with  
rubber coupling)  
fs: Maximum self-start  
frequency when not  
loaded

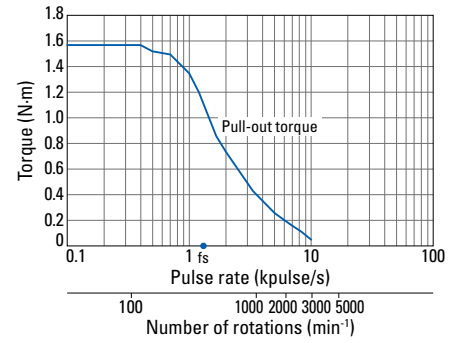

### SM2563C30U41 SM2563C30U11

Constant current circuit  
Source voltage: 24 VDC  
Operating current:  
3 A/phase, 2-phase  
excitation (full-step)  
Pull-out torque:  
 $J_L=7.4 \times 10^{-4} \text{kg}\cdot\text{m}^2$  (with  
rubber coupling)  
fs: Maximum self-start  
frequency when not  
loaded

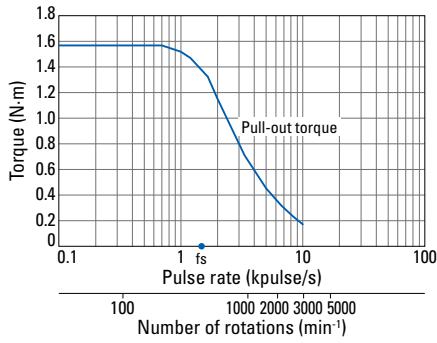

### SM2564C10U41 SM2564C10U11

Constant current circuit  
Source voltage: 24 VDC  
Operating current:  
1 A/phase, 2-phase  
excitation (full-step)  
Pull-out torque:  
 $J_L=7.4 \times 10^{-4} \text{kg}\cdot\text{m}^2$  (with  
rubber coupling)  
fs: Maximum self-start  
frequency when not  
loaded

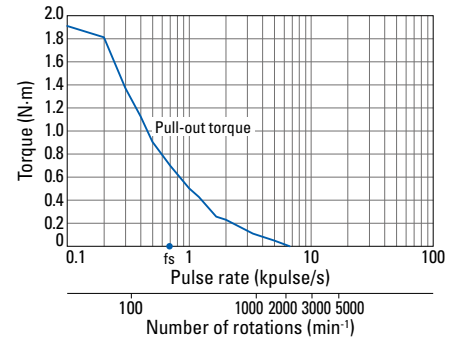

### SM2564C20U41 SM2564C20U11

Constant current circuit  
Source voltage: 24 VDC  
Operating current:  
2 A/phase, 2-phase  
excitation (full-step)  
Pull-out torque:  
 $J_L=7.4 \times 10^{-4} \text{kg}\cdot\text{m}^2$  (with  
rubber coupling)  
fs: Maximum self-start  
frequency when not  
loaded

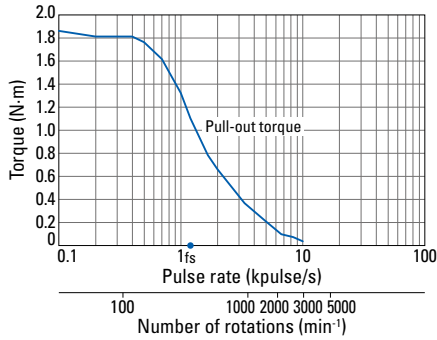

### SM2564C30U41 SM2564C30U11

Constant current circuit  
Source voltage: 24 VDC  
Operating current:  
3 A/phase, 2-phase  
excitation (full-step)  
Pull-out torque:  
 $J_L=7.4 \times 10^{-4} \text{kg}\cdot\text{m}^2$  (with  
rubber coupling)  
fs: Maximum self-start  
frequency when not  
loaded

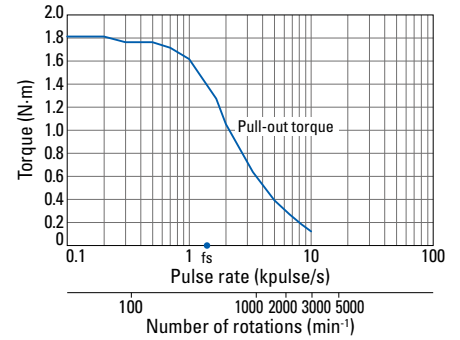

## Dimensions (Unit: mm)

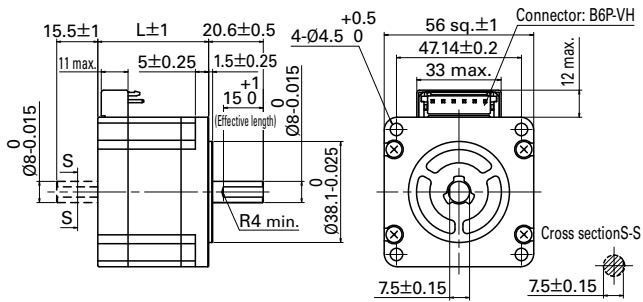

Option (sold separately): Unipolar motor cable 4837798-1

Manufacturer: J.S.T.  
Housing: VHR-6N  
Pin: SVH-21T-P1.1

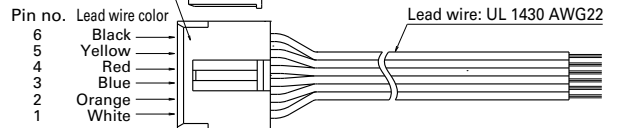

## Internal wiring ( ) connector pin number

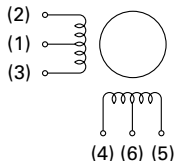

## Compatible drivers

- For motors with model nos. SM256□C20U□1 (2 A/phase)  
Model no.: US1D200P10 (DC input)  
Operating current selection switch setting: 0
  - For motors other than the above.  
We do not offer compatible drivers available.  
If you require assistance finding a driver, contact us.
- Note: The motor characteristics shown above use our experimental circuit.*



# 56 mm sq.

1.8°/step RoHS

Bipolar winding, connector type



Lineup → p. 7

Low-backlash gear model

Harmonic gear model

Electromagnetic brake model

Encoder model

## Bipolar winding, connector type

Model no.		Holding torque at 2-phase excitation N·m min.	Rated current A/phase	Wiring resistance Ω/phase	Winding inductance mH/phase	Rotor inertia ×10 <sup>-4</sup> kg·m <sup>2</sup>	Mass kg	Motor length (L) mm
Single shaft	Dual shaft							
SM2561C10B41	SM2561C10B11	0.75	1	4.6	13.5	0.14	0.49	41.8
SM2561C20B41	SM2561C20B11	0.75	2	1.1	3.5	0.14	0.49	41.8
SM2561C30B41	SM2561C30B11	0.75	3	0.51	1.5	0.14	0.49	41.8
SM2561C40B41	SM2561C40B11	0.75	4	0.28	0.85	0.14	0.49	41.8
SM2561C60B41	SM2561C60B11	0.75	6	0.14	0.38	0.14	0.49	41.8
SM2562C10B41	SM2562C10B11	1.4	1	6.3	25.5	0.28	0.69	53.8
SM2562C20B41	SM2562C20B11	1.4	2	1.5	6.5	0.28	0.69	53.8
SM2562C30B41	SM2562C30B11	1.4	3	0.68	2.9	0.28	0.69	53.8
SM2562C40B41	SM2562C40B11	1.4	4	0.37	1.5	0.28	0.69	53.8
SM2562C60B41	SM2562C60B11	1.4	6	0.18	0.72	0.28	0.69	53.8
SM2563C10B41	SM2563C10B11	2.35	1	8.6	36	0.5	1.1	75.8
SM2563C20B41	SM2563C20B11	2.35	2	2.1	9.5	0.5	1.1	75.8
SM2563C30B41	SM2563C30B11	2.35	3	0.95	4.2	0.5	1.1	75.8
SM2563C40B41	SM2563C40B11	2.35	4	0.52	2.4	0.5	1.1	75.8
SM2563C60B41	SM2563C60B11	2.35	6	0.25	1.05	0.5	1.1	75.8
SM2564C10B41	SM2564C10B11	2.5	1	9.4	41	0.6	1.27	85.8
SM2564C20B41	SM2564C20B11	2.5	2	2.1	11	0.6	1.27	85.8
SM2564C30B41	SM2564C30B11	2.5	3	0.95	4.9	0.6	1.27	85.8
SM2564C40B41	SM2564C40B11	2.5	4	0.59	2.8	0.6	1.27	85.8
SM2564C60B41	SM2564C60B11	2.5	6	0.27	1.15	0.6	1.27	85.8

Motor cable: model no. 4837961-1

## Characteristics diagram

### SM2561C10B41 SM2561C10B11

Constant current circuit  
Source voltage: 24 VDC  
Operating current:  
1 A/phase, 2-phase  
excitation (full-step)  
Pull-out torque:  
 $J_L=0.94 \times 10^{-4}$ kg·m<sup>2</sup> (with  
rubber coupling)  
fs: Maximum self-start  
frequency when not  
loaded

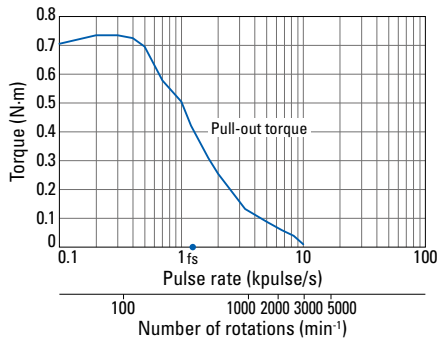

### SM2561C20B41 SM2561C20B11

Constant current circuit  
Source voltage: 24 VDC  
Operating current:  
2 A/phase, 2-phase  
excitation (full-step)  
Pull-out torque:  
 $J_L=0.94 \times 10^{-4}$ kg·m<sup>2</sup> (with  
rubber coupling)  
fs: Maximum self-start  
frequency when not  
loaded

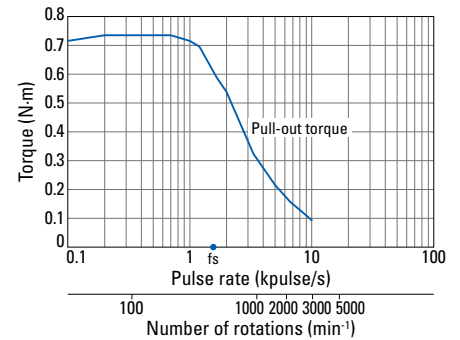

### SM2561C30B41 SM2561C30B11

Constant current circuit  
Source voltage: 24 VDC  
Operating current:  
3 A/phase, 2-phase  
excitation (full-step)  
Pull-out torque:  
 $J_L=0.94 \times 10^{-4}$ kg·m<sup>2</sup> (with  
rubber coupling)  
fs: Maximum self-start  
frequency when not  
loaded

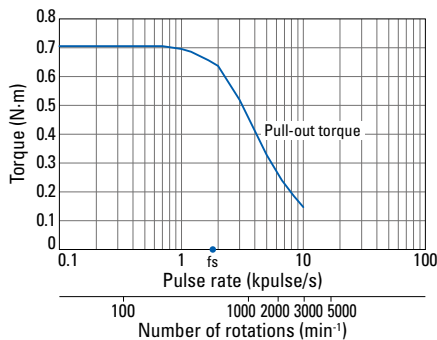

### SM2561C40B41 SM2561C40B11

Constant current circuit  
Source voltage: 24 VDC  
Operating current:  
4 A/phase, 2-phase  
excitation (full-step)  
Pull-out torque:  
 $J_L=0.94 \times 10^{-4}$ kg·m<sup>2</sup> (with  
rubber coupling)  
fs: Maximum self-start  
frequency when not  
loaded

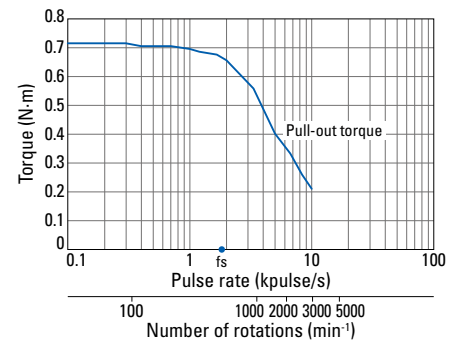

## Characteristics diagram

### SM2561C60B41 SM2561C60B11

Constant current circuit  
Source voltage: 24 VDC  
Operating current:  
6 A/phase, 2-phase  
excitation (full-step)  
Pull-out torque:  
 $J_L=0.94 \times 10^{-4} \text{kg}\cdot\text{m}^2$  (with  
rubber coupling)  
 $f_s$ : Maximum self-start  
frequency when not  
loaded

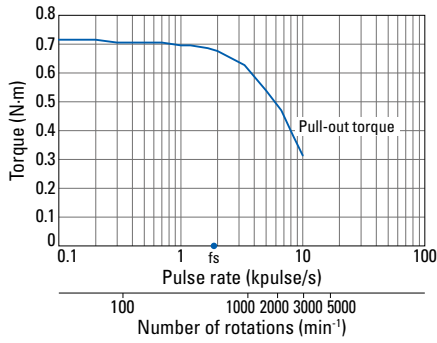

### SM2562C10B41 SM2562C10B11

Constant current circuit  
Source voltage: 24 VDC  
Operating current:  
1 A/phase, 2-phase  
excitation (full-step)  
Pull-out torque:  
 $J_L=2.6 \times 10^{-4} \text{kg}\cdot\text{m}^2$  (with  
 $f_s$ : Maximum self-start  
frequency when not  
loaded

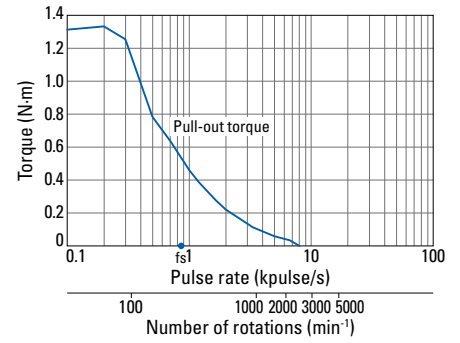

### SM2562C20B41 SM2562C20B11

Constant current circuit  
Source voltage: 24 VDC  
Operating current:  
2 A/phase, 2-phase  
excitation (full-step)  
Pull-out torque:  
 $J_L=2.6 \times 10^{-4} \text{kg}\cdot\text{m}^2$  (with  
rubber coupling)  
 $f_s$ : Maximum self-start  
frequency when not  
loaded

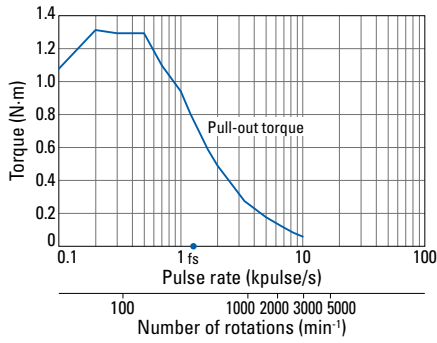

### SM2562C30B41 SM2562C30B11

Constant current circuit  
Source voltage: 24 VDC  
Operating current:  
3 A/phase, 2-phase  
excitation (full-step)  
Pull-out torque:  
 $J_L=2.6 \times 10^{-4} \text{kg}\cdot\text{m}^2$  (with  
rubber coupling)  
 $f_s$ : Maximum self-start  
frequency when not  
loaded

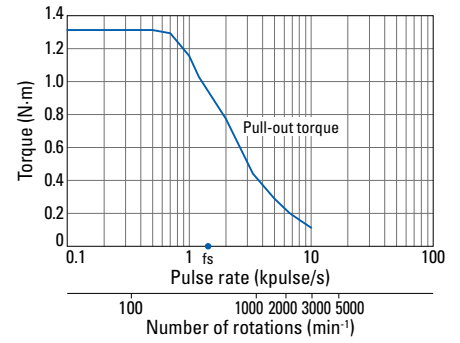

### SM2562C40B41 SM2562C40B11

Constant current circuit  
Source voltage: 24 VDC  
Operating current:  
4 A/phase, 2-phase  
excitation (full-step)  
Pull-out torque:  
 $J_L=2.6 \times 10^{-4} \text{kg}\cdot\text{m}^2$  (with  
rubber coupling)  
 $f_s$ : Maximum self-start  
frequency when not  
loaded

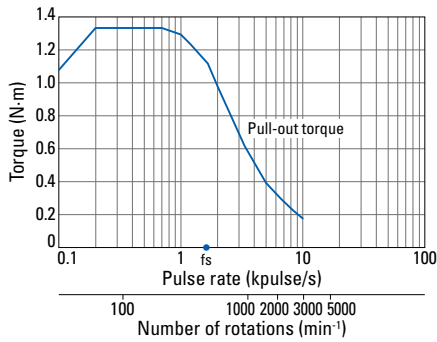

### SM2562C60B41 SM2562C60B11

Constant current circuit  
Source voltage: 24 VDC  
Operating current:  
6 A/phase, 2-phase  
excitation (full-step)  
Pull-out torque:  
 $J_L=2.6 \times 10^{-4} \text{kg}\cdot\text{m}^2$  (with  
rubber coupling)  
 $f_s$ : Maximum self-start  
frequency when not  
loaded

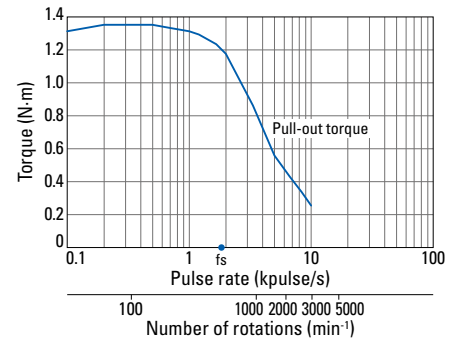

### SM2563C10B41 SM2563C10B11

Constant current circuit  
Source voltage: 24 VDC  
Operating current:  
1 A/phase, 2-phase  
excitation (full-step)  
Pull-out torque:  
 $J_L=7.4 \times 10^{-4} \text{kg}\cdot\text{m}^2$  (with  
rubber coupling)  
 $f_s$ : Maximum self-start  
frequency when not  
loaded

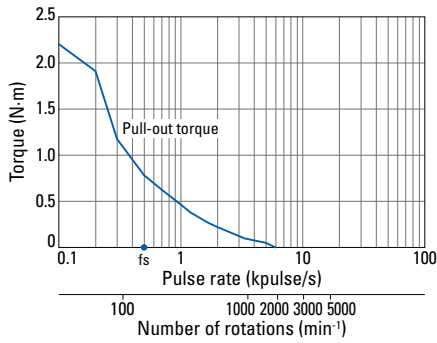

### SM2563C20B41 SM2563C20B11

Constant current circuit  
Source voltage: 24 VDC  
Operating current:  
2 A/phase, 2-phase  
excitation (full-step)  
Pull-out torque:  
 $J_L=7.4 \times 10^{-4} \text{kg}\cdot\text{m}^2$  (with  
rubber coupling)  
 $f_s$ : Maximum self-start  
frequency when not  
loaded

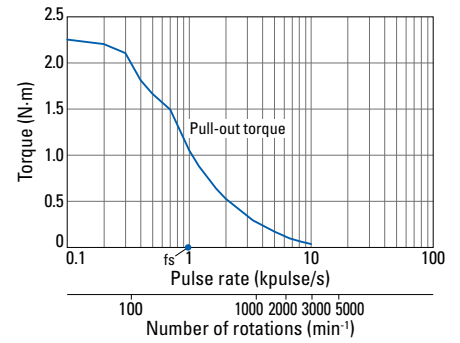

### SM2563C30B41 SM2563C30B11

Constant current circuit  
Source voltage: 24 VDC  
Operating current:  
3 A/phase, 2-phase  
excitation (full-step)  
Pull-out torque:  
 $J_L=7.4 \times 10^{-4} \text{kg}\cdot\text{m}^2$  (with  
rubber coupling)  
 $f_s$ : Maximum self-start  
frequency when not  
loaded

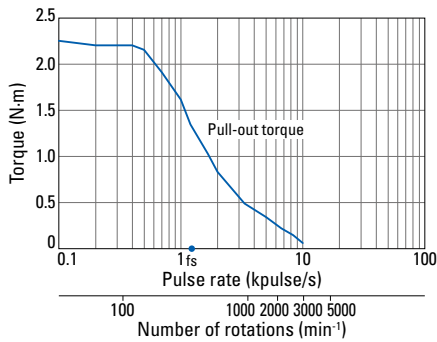

### SM2563C40B41 SM2563C40B11

Constant current circuit  
Source voltage: 24 VDC  
Operating current:  
4 A/phase, 2-phase  
excitation (full-step)  
Pull-out torque:  
 $J_L=7.4 \times 10^{-4} \text{kg}\cdot\text{m}^2$  (with  
rubber coupling)  
 $f_s$ : Maximum self-start  
frequency when not  
loaded

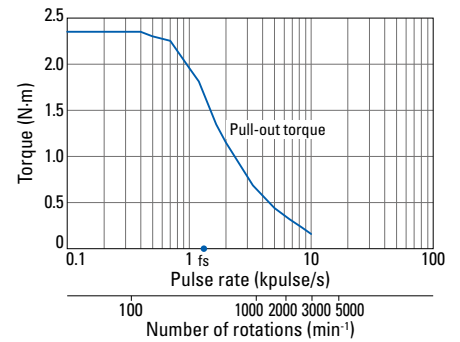

## Characteristics diagram

### SM2563C60B41 SM2563C60B11

Constant current circuit  
Source voltage: 24 VDC  
Operating current:  
6 A/phase, 2-phase  
excitation (full-step)  
Pull-out torque:  
 $J_L=7.4 \times 10^{-4} \text{kg}\cdot\text{m}^2$  (with  
rubber coupling)  
fs: Maximum self-start  
frequency when not  
loaded

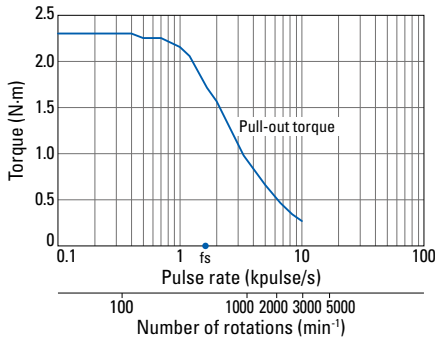

### SM2564C10B41 SM2564C10B11

Constant current circuit  
Source voltage: 24 VDC  
Operating current:  
1 A/phase, 2-phase  
excitation (full-step)  
Pull-out torque:  
 $J_L=7.4 \times 10^{-4} \text{kg}\cdot\text{m}^2$  (with  
rubber coupling)  
fs: Maximum self-start  
frequency when not  
loaded

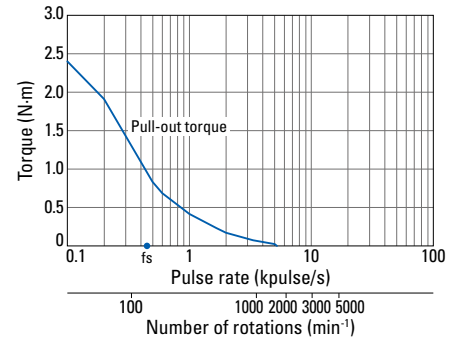

### SM2564C20B41 SM2564C20B11

Constant current circuit  
Source voltage: 24 VDC  
Operating current:  
2 A/phase, 2-phase  
excitation (full-step)  
Pull-out torque:  
 $J_L=7.4 \times 10^{-4} \text{kg}\cdot\text{m}^2$  (with  
rubber coupling)  
fs: Maximum self-start  
frequency when not  
loaded

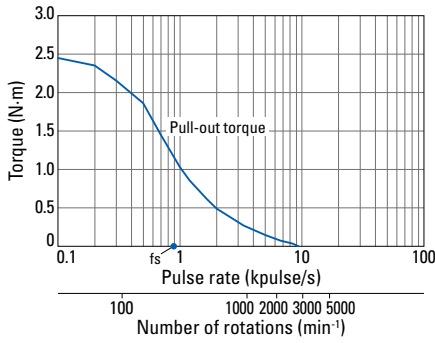

### SM2564C30B41 SM2564C30B11

Constant current circuit  
Source voltage: 24 VDC  
Operating current:  
3 A/phase, 2-phase  
excitation (full-step)  
Pull-out torque:  
 $J_L=7.4 \times 10^{-4} \text{kg}\cdot\text{m}^2$  (with  
fs: Maximum self-start  
frequency when not  
loaded

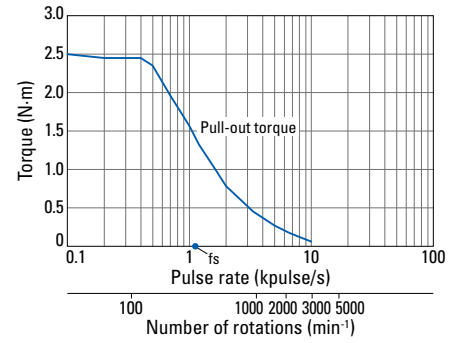

### SM2564C40B41 SM2564C40B11

Constant current circuit  
Source voltage: 24 VDC  
Operating current:  
4 A/phase, 2-phase  
excitation (full-step)  
Pull-out torque:  
 $J_L=7.4 \times 10^{-4} \text{kg}\cdot\text{m}^2$  (with  
rubber coupling)  
fs: Maximum self-start  
frequency when not  
loaded

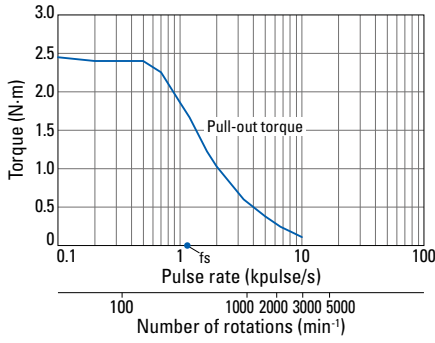

### SM2564C60B41 SM2564C60B11

Constant current circuit  
Source voltage: 24 VDC  
Operating current:  
6 A/phase, 2-phase  
excitation (full-step)  
Pull-out torque:  
 $J_L=7.4 \times 10^{-4} \text{kg}\cdot\text{m}^2$  (with  
rubber coupling)  
fs: Maximum self-start  
frequency when not  
loaded

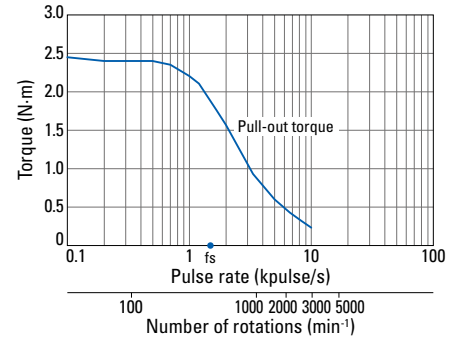

## Dimensions (Unit: mm)

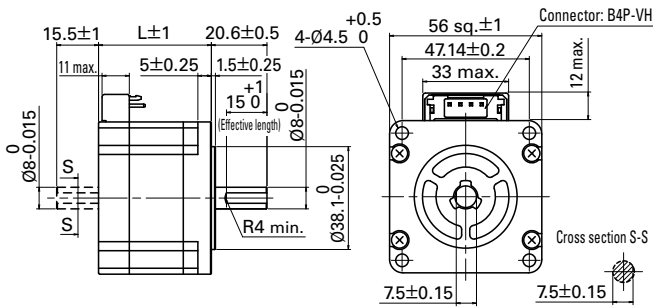

### Bipolar motor cable 4837961-1

Manufacturer: J.S.T.  
Housing: VHR-4N  
Pin: SVH-21T-P1.1

Pin no.	Lead wire color
4	Yellow
3	Red
2	Blue
1	Orange

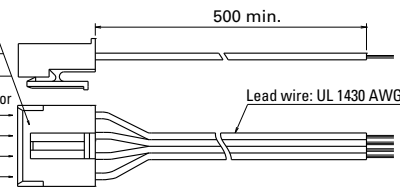

## Internal wiring ( ) connector pin number

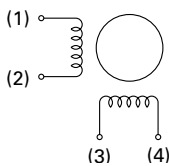

## Compatible drivers

- For motors with model nos. SM256 □ C20B □ 1 (2 A/phase)  
Model no.: BS1D200P10 (DC input)  
Operating current selection switch setting: 0
- For motors other than the above.  
We do not offer compatible drivers available.  
If you require assistance finding a driver, contact us.  
*Note: The motor characteristics shown above use our experimental circuit.*



# Rich motor lineup available for various needs

## Geared models

Applicable models: S□2561

### Low-backlash gear model

This model features low-backlash gear.

Allowable torque	N·m	1.25	2.5	3	3.5	4	4
Gear ratio	—	1:3.6	1:7.2	1:10	1:20	1:30	1:36
Backlash	° max.	0.55	0.25	0.25	0.17	0.17	0.17
Allowable speed	min <sup>-1</sup>	500	250	180	90	60	50
Allowable thrust load	N	30	30	30	30	30	30
Allowable radial load <sup>(1)</sup>	N	100	100	100	100	100	100

(1) When load is applied at 1/3 length from output shaft end.

· Directions of motor rotation and gear output shaft rotation are the same for models with gear ratios 1:3.6 and 1:7.2, and opposite for gear ratios 1:10, 1:20, 1:30, and 1:36.

### Harmonic gear model

This model has extremely low backlash and superb positioning precision. The lineup has high gear ratios of up to 1:100 available.

Allowable torque	N·m	5.5	8
Allowable peak torque	N·m	14	20
Gear ratio	—	1:50	1:100
Lost motion	Arc min	0.4 to 3 (at ±0.28 N·m)	0.4 to 1.5 (at ±0.4 N·m)
Allowable speed	min <sup>-1</sup>	70	35
Allowable peak speed	min <sup>-1</sup>	100	50
Allowable thrust load	N	400	400
Allowable radial load <sup>(2)</sup>	N	360	360

(2) When load is applied at 1/3 length from output shaft end.

The motor shaft and the gear output shaft rotate in the opposite directions.



## Electromagnetic brake model

Applicable models: All models listed in this catalog

The non-excitation electromagnetic brake holds a workpiece when power is lost, preventing it from falling.

Brake type	—	Non-excitation actuation type
Power supply voltage	—	24 VDC±5%
Power consumption	W	6 (at 75°C)
Static friction torque	N·m min.	0.8
Polarity	—	Red: +, Black: -



## Encoder models

Applicable models: All models listed in this catalog

This model can detect vibration and step-out by monitoring the motor's operation status such as position and speed.

Resolution	P/R	1000	2000	4000
Number of channels	CH	3	3	3
Output method	—	Line driver (CMOS)		
Max. response frequency	kHz	55	110	220
Power supply voltage	—	5 V±5%	5 V±5%	5 V±5%
Current consumption	mA max.	100	100	100

