

SIDE VIEW

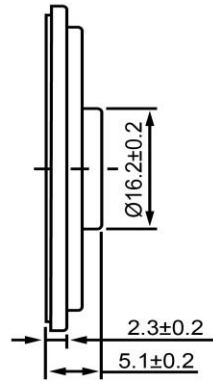

BOTTOM VIEW

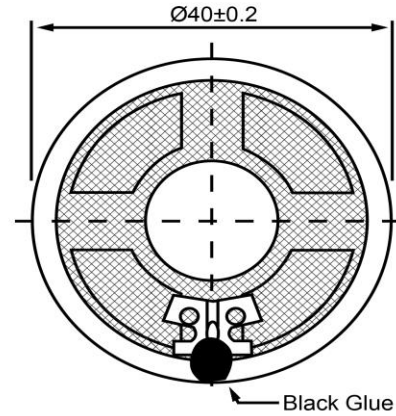

Specifications

Description	Value	Unit
Shape	Round	
Resonant Frequency	600	(Hz)
Frequency Range	600 ~ 6,000	(Hz)
SPL @ 10cm	92	(dBA)
Impedance	8	(Ohm)
Cone Material	Mylar	
Nominal Power	0.5	(W)
Max Power	0.8	(W)
Mount Type	Flush Mount	
Operating Temperature	-20 ~ +60	°C
Storage Temperature	-30 ~ +60	°C
Weight	9.2	(g)

Notes

- 1) All dimensions are in mm unless otherwise noted
- 2) All parts meet RoHS



Revision History

Version	Description	Date	Approved		
1	Released from Engineering	2/5/2014	J.S.		
Drawn by	Date	Checked by	Date	Approved by	Date
G.W.	1/27/2014	C.E.	2/4/2014	J.S.	2/5/2014

Dynamic Speaker

SM400608-2