

# VALU-BEAM® Series Opposed Mode Sensor Pairs



## Datasheet

*Opposed mode sensor pairs with enhanced sunlight immunity*



- Opposed mode sensing to 30 meters (100 ft); enhanced sunlight immunity for difficult applications
- Choice of three modulation codes enables adjacent sensor pairs to operate without crosstalk
- 10 to 30 V DC, three-wire operation (2-wire emitters)
- Solid-state bipolar outputs, 150 mA maximum (continuous); sinking or sourcing hookup (usable simultaneously)
- Totally encapsulated circuitry in a rugged, molded, plastic housing, rated NEMA 6P (IEC IP67)



### WARNING:

- **Do not use this device for personnel protection**
- Using this device for personnel protection could result in serious injury or death.
- This device does not include the self-checking redundant circuitry necessary to allow its use in personnel safety applications. A device failure or malfunction can cause either an energized (on) or de-energized (off) output condition.

Model <sup>1</sup>	Description	Code	Connection	Recommended Accessory Cable
SM91EAN	Emitter	A	6.5 ft attached cable	
SM91EANQD			3-pin Mini-style quick disconnect (QD)	MBCC-312
SM91RAN	Receiver		6.5 ft attached cable	
SM91RANQD			4-pin Mini-style quick disconnect (QD)	MBCC-412
SM91EBN	Emitter	B	6.5 ft attached cable	
SM91EBNQD			3-pin Mini-style quick disconnect (QD)	MBCC-312
SM91RBN	Receiver		6.5 ft attached cable	
SM91RBNQD			4-pin Mini-style quick disconnect (QD)	MBCC-412
SM91ECN	Emitter	C	6.5 ft attached cable	
SM91ECNQD			3-pin Mini-style quick disconnect (QD)	MBCC-312
SM91RCN	Receiver		6.5 ft attached cable	
SM91RCNQD			4-pin Mini-style quick disconnect (QD)	MBCC-412

## Overview

These rugged, powerful VALU-BEAM® opposed mode emitter/receiver pairs are designed to function in difficult environments. Excess gain is conservatively rated at 100x at an emitter-to-receiver separation distance of 3 meters (10 ft).

Receivers will not false-trigger when pointed directly into a light source of 120,000 lux. Even under these conditions, a receiver will respond only to the light signal from its modulated emitter. Receivers are also immune to false triggering by sunlight reflected from water droplets.

Receivers are immune to interference from flashing strobe lights as are typically found on plant lift trucks. Sensors are also immune to interference from a 5 Watt handheld transceiver, operating on specified frequencies, held 6 inches away from the sensor.

Emitters and receivers that are to be used together must carry the same modulation code designation (A, B, or C). Sensor pairs of one code may be used alongside sensor pairs of another code, without interference or crosstalk.

These sensors are ruggedly constructed in reinforced, molded, PBT polyester housings with replaceable acrylic lenses. Electronics are fully epoxy-encapsulated. Sensors are constructed to NEMA 6P (IEC IP67) standards. These sensors will withstand temporary submersion. Operating temperature range is -20 °C to +70 °C (-4 °F to +158 °F).

The sensors operate from 10 to 30 V dc (reverse polarity and short-circuit protected). Receivers have one solid-state light-operate PNP (sourcing) output and one solid-state light-operate NPN (sinking) output with a continuous load capability of 150 mA maximum (each output). A green indicator LED on each emitter lights whenever the infrared sensing beam is being emitted. Receivers have Banner's patented AID™ (Alignment Indicating Device) system<sup>2</sup>, which lights a red LED whenever the output is conducting and pulses the LED at a rate proportional to the strength of the received light signal.

## Sensor Codes and Response Times

Emitters and receivers that are to be used together must carry the same code letter. Sensors of one code may be used side-by-side with sensors of another code, without interference or crosstalk. Sensor pairs carrying the same code must be separated by a minimum side-to-side distance of 22 inches (assuming an emitter/receiver separation distance of 10 feet; see beam pattern) to avoid crosstalk.

The codes A, B, and C are used to designate different sensing pulse modulation frequencies and different intervals between sets of pulses. These design differences are necessary to enable differently coded sensor pairs to operate in close proximity without interfering with each other.

These internal timing differences result in differing response times to light and dark signals in the differently-coded sensor pairs. See [Table 1](#) on p. 2 for the response times when each sensor pair is operated alone, outside the field of view of another sensor pair.

<sup>1</sup> To order the 30 meter attached cable models, add a "W/30" to the standard cabled model number. For example, SM91EAN W/30.  
<sup>2</sup> U.S. patent number 4356393



Table 1: Response time of individual sensor pairs, alone

	Sensor Codes		
	A	B	C
Response to dark signal	12 ms	20 ms	20 ms
Response to light signal	20 ms	17 ms	28 ms

Differently-coded sensor pairs in a common field of view may not perform as described in Table 1 on p. 2. To prevent unwanted response, a receiver operating under worst-case conditions may require some additional time to verify that the signal it sees is actually coming from its own companion emitter. These worst-case response times are given in Table 2 on p. 2.

Table 2: Response time of adjacent sensor pairs in a common field of view

	Sensor Codes		
	A + B	A + C	A + B + C
Response to dark signal	A = 12 ms; B = 20 ms	A = 12 ms; C = 20 ms	A = 12 ms; B = 20 ms; C = 40 ms
Response to light signal	Doubles A, B	Doubles A, C	Triples A, B, C

## Wiring Diagrams

### Emitter 6.5 ft Cable Model      Emitter 3-pin Mini-style Male QD Model

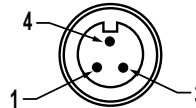
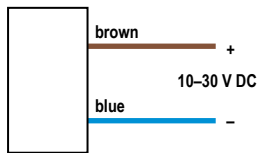

- 1 - brown
- 3 - blue
- 4 - black (not used)

### Receiver NPN Output      Receiver PNP Output      Receiver 4-pin Mini-style Male QD Model

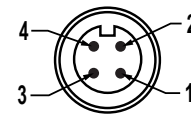
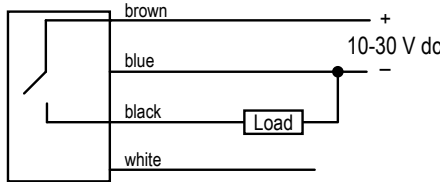
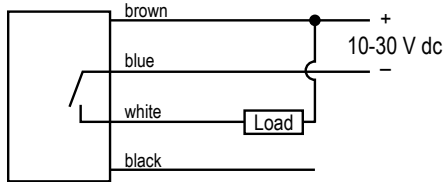

- 1 - brown
- 2 - white
- 3 - blue
- 4 - black

## Specifications

### Supply Voltage

10 to 30 V dc at 20 mA maximum for receivers (exclusive to load current) and 25 mA maximum for emitters

### Sensor Beam

Opposed mode  
Modulated infrared, 880 nm

### Range

100x excess gain at 3 m (10 ft) emitter-receiver separation distance (see excess gain curve)

### Effective Beam Diameter

25 mm (1 in)

### Sunlight Immunity

Receivers may be pointed into a light source of 120,000 lux without false-triggering, and will still respond only to the infrared beam from their modulated emitters. Receivers will not respond to sunlight reflected from water spray droplets.

### Construction

Reinforced black PBT polyester housing, electronics are epoxy-encapsulated  
Lenses: Molded, replaceable acrylic

### Connection

2 m (6.5 ft) or 9 m (30 ft) attached PVC-jacketed cable; or integral mini-style quick disconnect (QD) fitting. QD connector housing and pins are isolated to 2500 V.

### Indicators

Top-mounted LED indicator.  
Red LED on (receiver): Output is conducting  
Red LED flashing (receiver): Pulses at a rate proportional to the strength of the received light signal.  
Green LED on (emitter): Infrared sensing beam is "on"

### Operating Temperature Range

-20 °C to +70 °C (-4 °F to +158 °F)

### Response Time

12 to 28 ms, depending upon code

### Output Configuration

Bipolar solid-state dc PNP sourcing and NPN sinking outputs, light operate only (outputs conduct when the receiver sees the modulated light from its emitter)

### Output Rating

150 mA maximum (continuous, each output)  
OFF-state leakage current: 100 µA, maximum  
ON-state saturation voltage: < 1 V at 10 mA and < 2 V at 150 mA (PNP); < 200 mV at 10 mA and < 1 V at 150 mA (NPN)

### Environmental Rating

NEMA 6P; IEC IP67

### Water Immersion

Emitters and receivers are rated NEMA 6P (IEC IP67). Sensors continue to operate during and after being submerged in water at a depth of 6 feet for a period of 48 hours. Immersion greatly reduces the efficiency of the lens, which results in greatly diminished sensing range.

### Strobe Light Immunity

Receivers are immune to one Federal Signal Corp. "Fireball" model FB2PST strobe.

### EMI-RFI Immunity

Emitters and receivers will not respond to transmissions from a 5 Watt output handheld transceiver on the test frequencies of 464.500 and 151.625 MHz when the transceiver's antenna is held 6 inches or more away from the sensor.

## Performance Curves

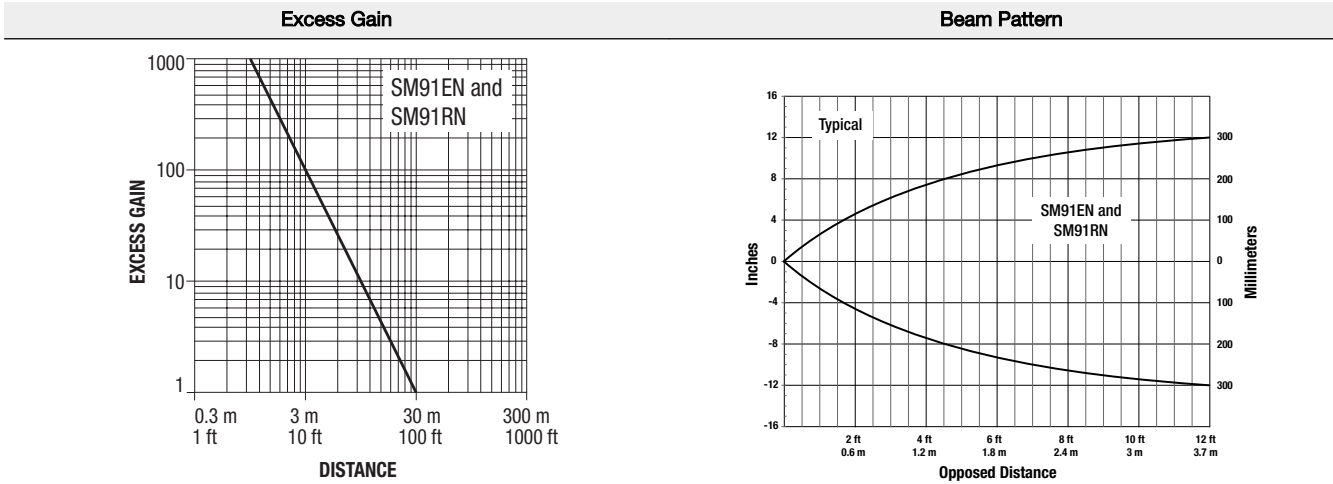

## Dimensions

All measurements are listed in millimeters [inches], unless noted otherwise.

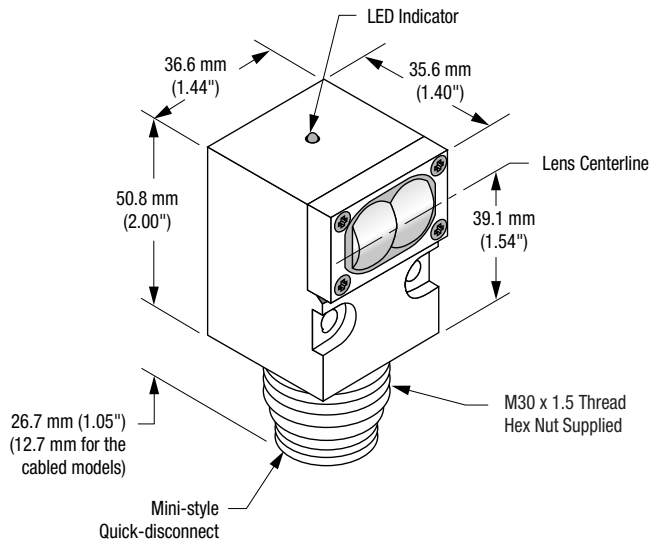

## Accessories

### Cordsets for Emitters

3-Pin Mini-Style Cordsets				
Model	Length	Style	Dimensions	Pinout (Female)
MBCC-306	1.83 m (6 ft)	Straight		<p style="font-size: small; margin-top: 5px;">1 = Brown 3 = Blue 4 = Black</p>
MBCC-312	3.66 m (12 ft)			
MBCC-330	9.14 m (30 ft)			