

## Cascadable Amplifier 10 to 500 MHz

Rev. V3

### Features

- High Reverse Isolation: 22 dB
- High Output Power: 18 dBm

### Description

The A180 RF amplifier is a discrete hybrid design, which uses thin film manufacturing processes for accurate performance and high reliability. This single stage bipolar transistor feedback amplifier design displays impressive performance over a broadband frequency range. An active DC biasing network insures temperature-stable performance.

Both TO-8 and surface mount packages are hermetically sealed, and MIL-STD-883 environmental screening is available.

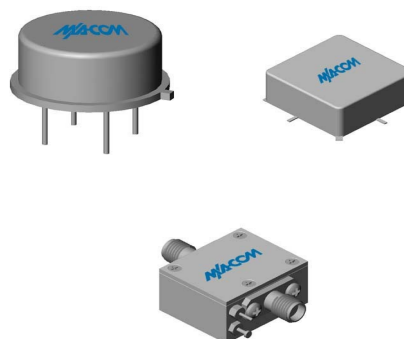

### Electrical Specifications: $Z_0 = 50 \Omega$ , $V_{CC} = 15 V_{DC}$ Nominal\*

Parameter	Units	Typical	Guaranteed	
		25°C	0° to 50°C	-54° to +85°C*
Frequency	MHz	5 - 600	10 - 500	10 - 500
Small Signal Gain (min.)	dB	16.5	16.0	15.5
Gain Flatness (max.)	dB	±0.3	±0.7	±1.0
Reverse Isolation	dB	22	—	—
Noise Figure (max.)	dB	3.4	4.0	4.5
Power Output @ 1 dB comp. (min.)	dBm	18	16	15
IP3	dBm	33	—	—
IP2	dBm	45	—	—
Second Order Harmonic IP	dBm	51	—	—
VSWR Input / Output (max.)		1.4:1 / 1.5:1	1.9:1 / 2.1:1	2.1:1 / 2.2:1
DC Current @ 15 Volts (max.)	mA	36	39	43

\* Over temperature performance limits for part number CA180, guaranteed from 0°C to +50°C only.

### Ordering Information

Part Number	Package
A180	TO-8
SMA180	Surface Mount
CA180 **	SMA Connectorized

\*\* The connectorized version is not RoHs compliant.

## Thermal Data: $V_{CC} = +15 V_{DC}$

Parameter	Rating
Thermal Resistance $\theta_{jc}$	45°C/W
Transistor Power Dissipation $P_d$	0.509 W
Junction Temperature Rise Above Case $T_{jc}$	+22.9°C

## Absolute Maximum Ratings

Parameter	Absolute Maximum
Storage Temperature	-62°C to +125°C
Case Temperature	+125°C
DC Voltage	+17 V
Continuous Input Power	+15 dBm
Short Term Input power (1 minute max.)	100 mW
Peak Power (3 $\mu$ sec max.)	0.5 W
"S" Series Burn-In Temperature (case)	+125°C

## Typical Performance Curves

**Gain**

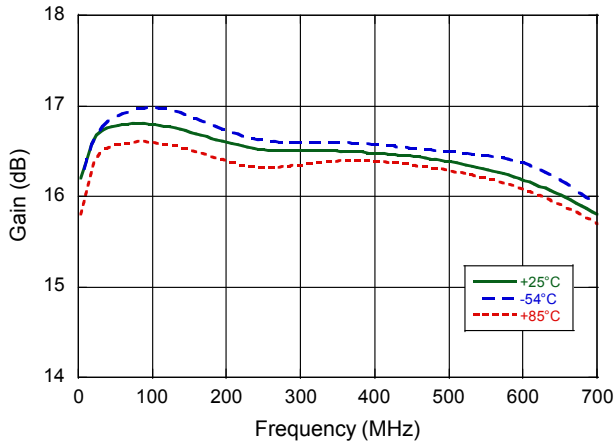

**Noise Figure**

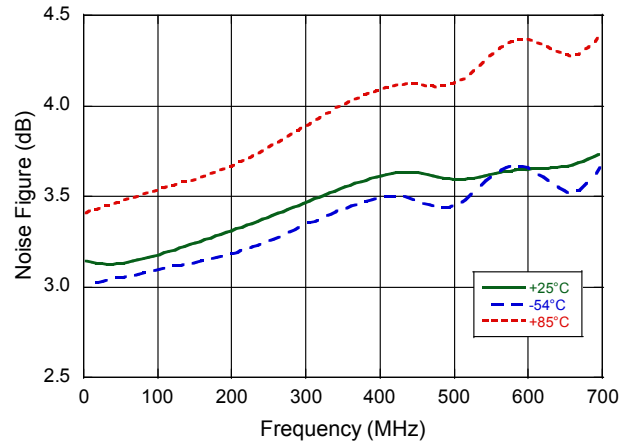

**Output Power @ 1 dB Gain Compression**

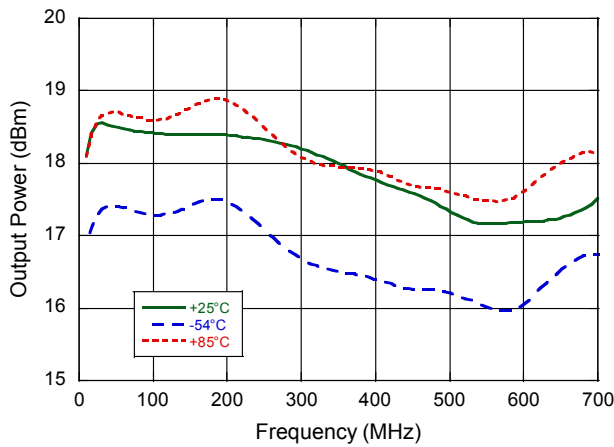

**Intercept Point**

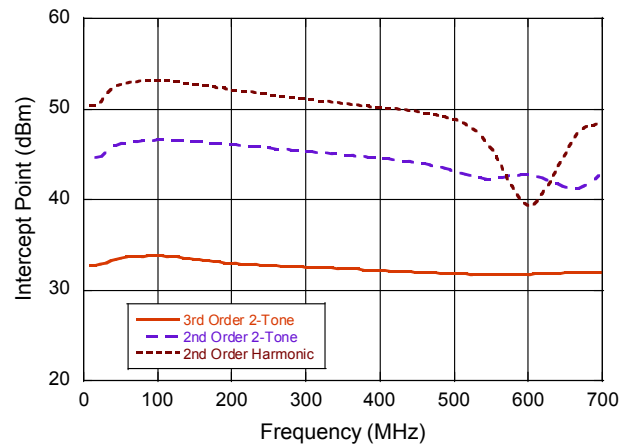

**VSWR**

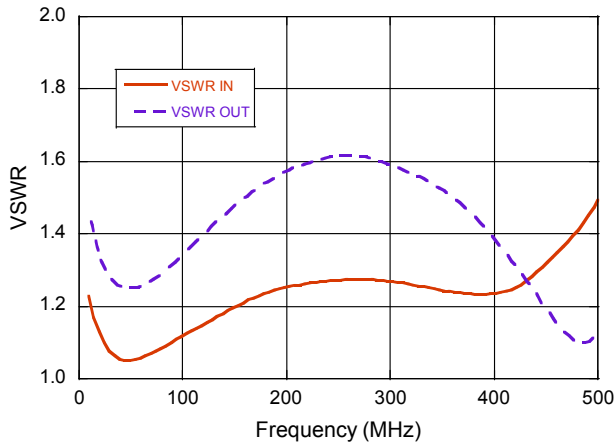

## Cascadable Amplifier 10 to 500 MHz

Rev. V3

### Outline Drawings<sup>2</sup>:

#### TO-8B

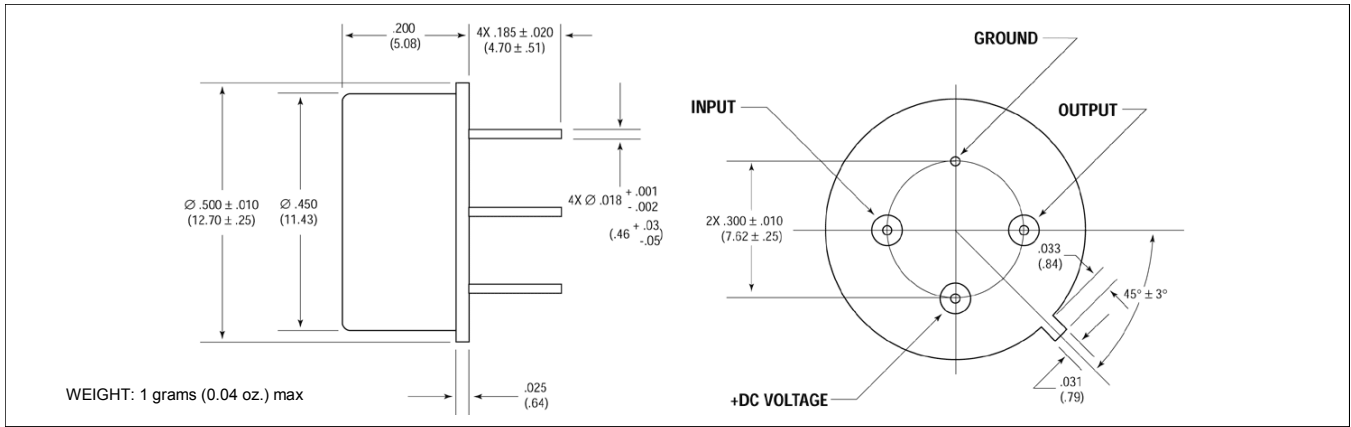

#### Surface Mount

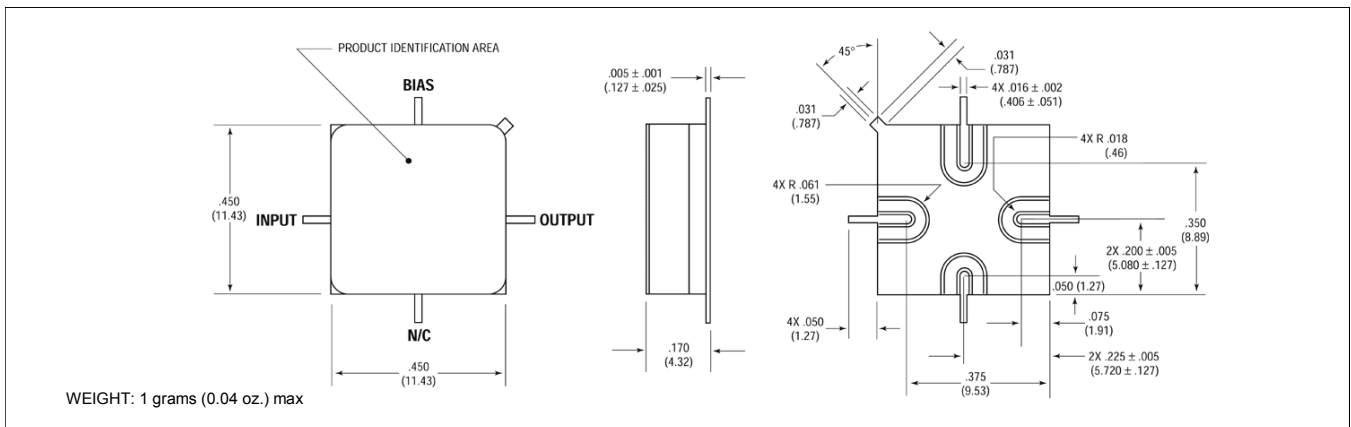

#### SMA Connectorized

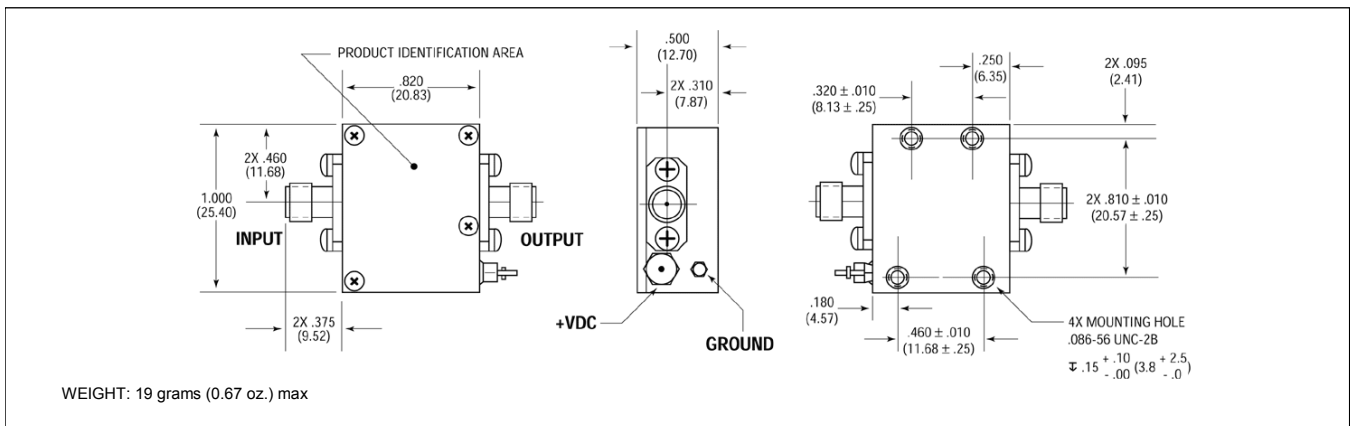

4

2. Dimensions are inches (millimeters) ±0.015 (0.38) unless otherwise specified.

MACOM Technology Solutions Inc. (MACOM) and its affiliates reserve the right to make changes to the product(s) or information contained herein without notice. Visit [www.macom.com](http://www.macom.com) for additional data sheets and product information.

For further information and support please visit:  
<https://www.macom.com/support>

DC-xxxxxxx