

## 400W, 12V - 60V Surface Mount Transient Voltage Suppressor

### FEATURES

- AEC-Q101 qualified
- Glass passivated chip junction
- Maximum  $V_{BR}$  temperature coefficient: 0.095%/°C
- Moisture sensitivity level: level 1, per J-STD-020
- RoHS Compliant
- Halogen-free according to IEC 61249-2-21

### APPLICATIONS

- Switching mode power supply (SMPS)
- Motor for BLDC
- Lighting application
- Battery Management System
- Automotive

### MECHANICAL DATA

- Case: Thin SMA
- Molding compound meets UL 94V-0 flammability rating
- Terminal: Matte tin plated leads, solderable per J-STD-002
- Meet JESD 201 class 2 whisker test
- Polarity: Uni-directional
- Weight: 0.030g (approximately)

KEY PARAMETERS		
PARAMETER	VALUE	UNIT
$V_{WM}$	12 - 60	V
$V_{BR}$	13.4 - 74.1	V
$P_{PPM}$	400	W
$T_{JMAX}$	175	°C
Package	Thin SMA	
Configuration	Single die	



Thin SMA



ABSOLUTE MAXIMUM RATINGS ( $T_A = 25^\circ\text{C}$ unless otherwise noted)			
PARAMETER	SYMBOL	VALUE	UNIT
Non-repetitive peak impulse power dissipation with 10/1000us waveform <sup>(1)</sup>	$P_{PPM}$	400	W
Steady state power dissipation at $T_L = 25^\circ\text{C}$ <sup>(2)</sup>	$P_D$	7.5	W
Forward Voltage @ $I_F = 25\text{A}$ for Uni-directional only <sup>(3)</sup>	$V_F$	3.5	V
Junction temperature	$T_J$	-55 to +175	°C
Storage temperature	$T_{STG}$	-55 to +175	°C

#### Notes:

1. Non-repetitive current pulse per fig.3 and derated above  $T_A = 25^\circ\text{C}$  per fig.1
2. Units mounted on PCB (5mm x 5mm Cu pad test board)
3. Pulse test with  $PW = 0.3\text{ms}$

<b>THERMAL PERFORMANCE</b>			
<b>PARAMETER</b>	<b>SYMBOL</b>	<b>TYP</b>	<b>UNIT</b>
Junction-to-lead thermal resistance	$R_{\theta JL}$	20	°C/W
Junction-to-ambient thermal resistance	$R_{\theta JA}$	62	°C/W
Junction-to-case thermal resistance	$R_{\theta JC}$	16	°C/W

**Thermal Performance Note:** Units mounted on PCB (5mm x 5mm Cu pad test board)

<b>ELECTRICAL SPECIFICATIONS</b> ( $T_A = 25^\circ\text{C}$ unless otherwise noted)								
Part number	Marking code	Breakdown voltage $V_{BR}@I_T$ (V) (Note 1)		Test current $I_T$ (mA)	Working stand-off voltage $V_{WM}$ (V)	Maximum blocking leakage current $I_R@V_{WM}$ ( $\mu\text{A}$ ) (Note 1)	Maximum peak impulse current $I_{PPM}$ (A) $t_p = 10/1000\mu\text{s}$	Maximum clamping voltage $V_C@I_{PPM}$ (V)
		Min	Max					
SMA4F12AH	4F012	13.4	14.8	1	12	1	20.5	19.5
SMA4F15AH	4F015	16.8	18.5	1	15	1	16.4	24.4
SMA4F18AH	4F018	20.1	22.2	1	18	1	13.7	29.2
SMA4F20AH	4F020	22.4	24.7	1	20	1	12.3	32.5
SMA4F21AH	4F021	23.5	25.9	1	21	1	11.7	34.1
SMA4F22AH	4F022	24.6	27.2	1	22	1	11.2	35.7
SMA4F24AH	4F024	26.8	29.6	1	24	1	10.3	39.0
SMA4F25AH	4F025	27.9	30.9	1	25	1	9.9	40.6
SMA4F26AH	4F026	29.1	32.1	1	26	1	9.5	42.2
SMA4F30AH	4F030	33.5	37.1	1	30	1	8.2	48.7
SMA4F33AH	4F033	36.9	40.8	1	33	1	7.5	53.6
SMA4F36AH	4F036	40.2	44.5	1	36	1	6.8	58.4
SMA4F39AH	4F039	43.6	48.2	1	39	1	6.3	63.3
SMA4F40AH	4F040	44.7	49.4	1	40	1	6.2	64.9
SMA4F43AH	4F043	48.1	53.1	1	43	1	5.7	69.8
SMA4F47AH	4F047	52.5	58.1	1	47	1	5.2	76.3
SMA4F51AH	4F051	57.0	63.0	1	51	1	4.8	82.8
SMA4F56AH	4F056	62.6	69.2	1	56	1	4.4	90.9
SMA4F60AH	4F060	67.1	74.1	1	60	1	4.1	97.4

**Note:**

1. Pulse test with PW = 30ms

<b>ORDERING INFORMATION</b>		
<b>ORDERING CODE<sup>(1)</sup></b>	<b>PACKAGE</b>	<b>PACKING</b>
SMA4FxxAH	Thin SMA	14,000 / Tape & Reel

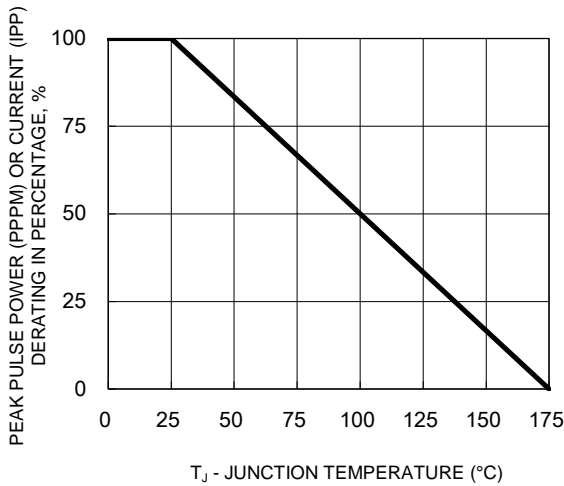
**Notes:**

- (1) "xx" defines voltage from 12V (SMA4F12AH) to 60V (SMA4F60AH)

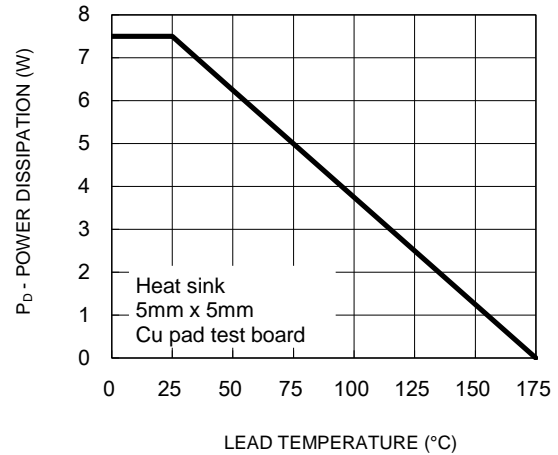
**CHARACTERISTICS CURVES**

( $T_A = 25^\circ\text{C}$  unless otherwise noted)

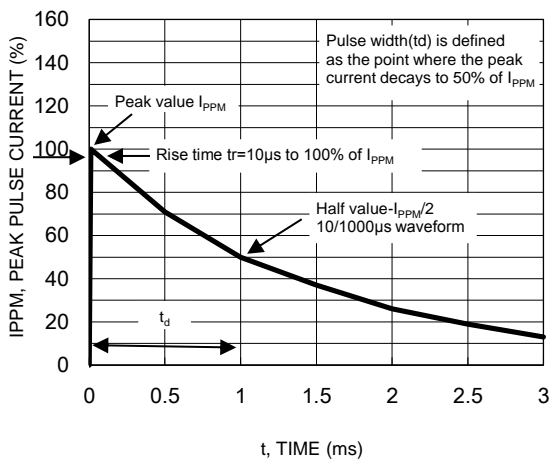
**Fig.1 Pulse Power or Current vs. Initial Junction Temperature**



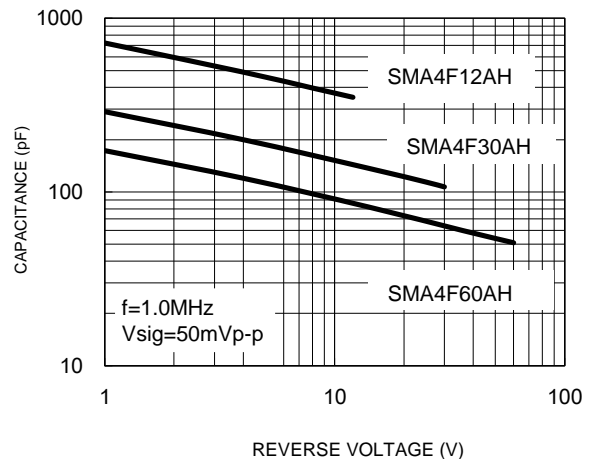
**Fig.2 Steady State Power Derating**



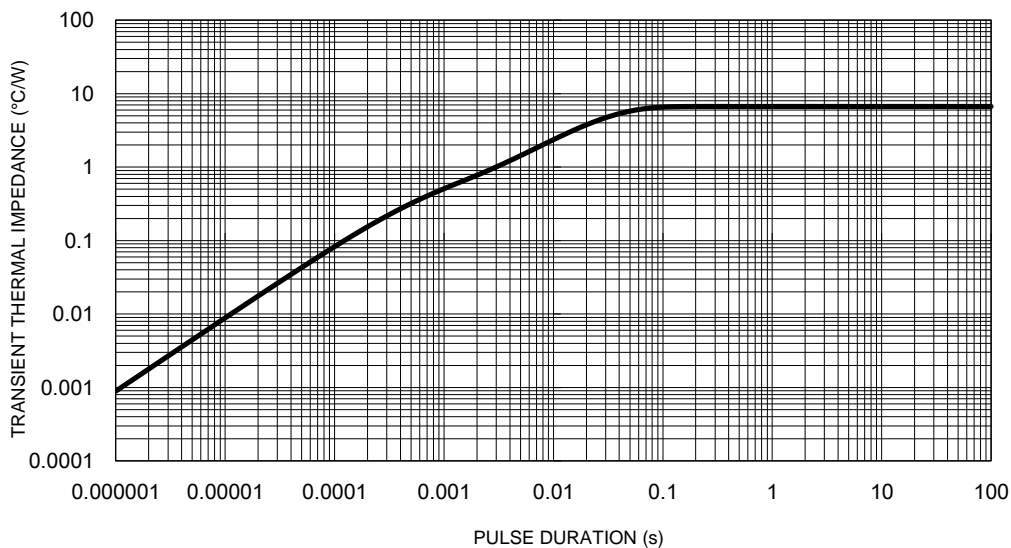
**Fig.3 Clamping Power Pulse Waveform**



**Fig.4 Typical Junction Capacitance**

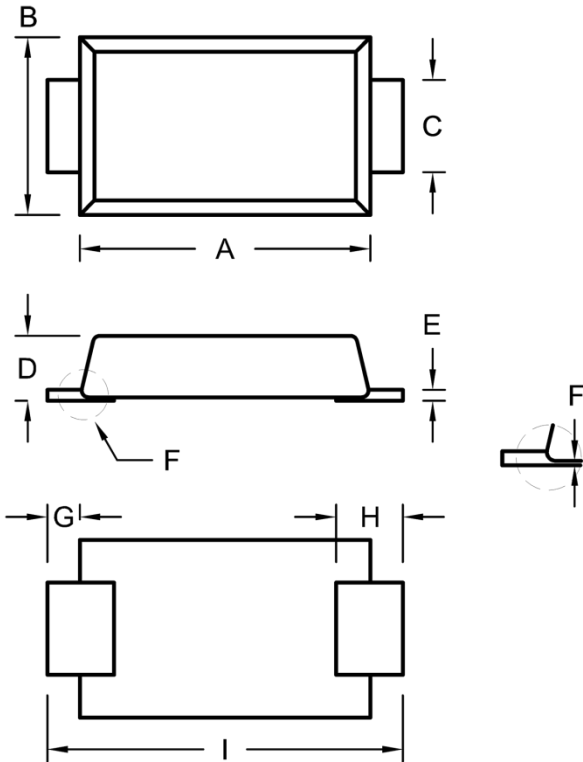


**Fig.5 Typical Transient Thermal Impedance**



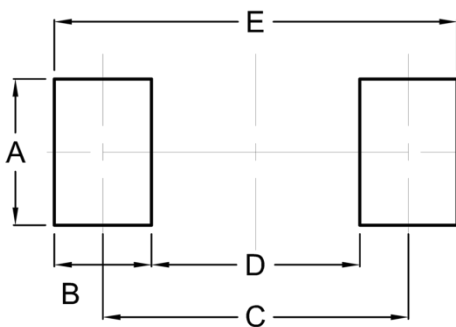
**PACKAGE OUTLINE DIMENSIONS**

Thin SMA



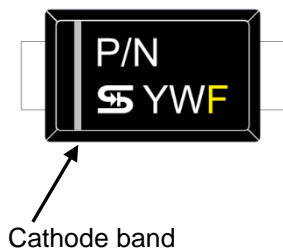
DIM.	Unit (mm)		Unit (inch)	
	Min.	Max.	Min.	Max.
A	4.15	4.35	0.163	0.171
B	2.50	2.70	0.098	0.106
C	1.25	1.45	0.049	0.057
D	0.90	1.00	0.035	0.039
E	0.10	0.22	0.004	0.009
F	0.00	0.10	0.000	0.004
G	0.30	0.60	0.012	0.024
H	0.75	1.20	0.030	0.047
I	5.05	5.35	0.199	0.211

**SUGGESTED PAD LAYOUT**



Symbol	Unit (mm)	Unit (inch)
A	2.10	0.083
B	1.40	0.055
C	4.40	0.173
D	3.00	0.118
E	5.80	0.228

**MARKING DIAGRAM**



- P/N = Marking Code
- YW = Date Code
- F = Factory Code