

400W, 12V - 60V Surface Mount Transient Voltage Suppressor

FEATURES

- AEC-Q101 qualified
- Glass passivated chip junction
- Maximum V_{BR} temperature coefficient: 0.095%/°C
- Moisture sensitivity level: level 1, per J-STD-020
- RoHS Compliant
- Halogen-free according to IEC 61249-2-21

APPLICATIONS

- Switching mode power supply (SMPS)
- Motor for BLDC
- Lighting application
- Battery Management System
- Automotive

MECHANICAL DATA

- Case: Thin SMA
- Molding compound meets UL 94V-0 flammability rating
- Terminal: Matte tin plated leads, solderable per J-STD-002
- Meet JESD 201 class 2 whisker test
- Polarity: Uni-directional
- Weight: 0.030g (approximately)

KEY PARAMETERS		
PARAMETER	VALUE	UNIT
V_{WM}	12 - 60	V
V_{BR}	13.4 - 74.1	V
P_{PPM}	400	W
T_{JMAX}	175	°C
Package	Thin SMA	
Configuration	Single die	



Thin SMA



ABSOLUTE MAXIMUM RATINGS ($T_A = 25^\circ\text{C}$ unless otherwise noted)

PARAMETER	SYMBOL	VALUE	UNIT
Non-repetitive peak impulse power dissipation with 10/1000us waveform ⁽¹⁾	P_{PPM}	400	W
Steady state power dissipation at $T_L = 25^\circ\text{C}$ ⁽²⁾	P_D	7.5	W
Forward Voltage @ $I_F = 25\text{A}$ for Uni-directional only ⁽³⁾	V_F	3.5	V
Junction temperature	T_J	-55 to +175	°C
Storage temperature	T_{STG}	-55 to +175	°C

Notes:

1. Non-repetitive current pulse per fig.3 and derated above $T_A = 25^\circ\text{C}$ per fig.1
2. Units mounted on PCB (5mm x 5mm Cu pad test board)
3. Pulse test with $PW = 0.3\text{ms}$

THERMAL PERFORMANCE			
PARAMETER	SYMBOL	TYP	UNIT
Junction-to-lead thermal resistance	$R_{\theta JL}$	20	°C/W
Junction-to-ambient thermal resistance	$R_{\theta JA}$	62	°C/W
Junction-to-case thermal resistance	$R_{\theta JC}$	16	°C/W

Thermal Performance Note: Units mounted on PCB (5mm x 5mm Cu pad test board)

ELECTRICAL SPECIFICATIONS ($T_A = 25^\circ\text{C}$ unless otherwise noted)								
Part number	Marking code	Breakdown voltage $V_{BR}@I_T$ (V) (Note 1)		Test current I_T (mA)	Working stand-off voltage V_{WM} (V)	Maximum blocking leakage current $I_R@V_{WM}$ (μA) (Note 1)	Maximum peak impulse current I_{PPM} (A) $t_p = 10/1000\mu\text{s}$	Maximum clamping voltage $V_C@I_{PPM}$ (V)
		Min	Max					
SMA4F12AH	4F012	13.4	14.8	1	12	1	20.5	19.5
SMA4F15AH	4F015	16.8	18.5	1	15	1	16.4	24.4
SMA4F18AH	4F018	20.1	22.2	1	18	1	13.7	29.2
SMA4F20AH	4F020	22.4	24.7	1	20	1	12.3	32.5
SMA4F21AH	4F021	23.5	25.9	1	21	1	11.7	34.1
SMA4F22AH	4F022	24.6	27.2	1	22	1	11.2	35.7
SMA4F24AH	4F024	26.8	29.6	1	24	1	10.3	39.0
SMA4F25AH	4F025	27.9	30.9	1	25	1	9.9	40.6
SMA4F26AH	4F026	29.1	32.1	1	26	1	9.5	42.2
SMA4F30AH	4F030	33.5	37.1	1	30	1	8.2	48.7
SMA4F33AH	4F033	36.9	40.8	1	33	1	7.5	53.6
SMA4F36AH	4F036	40.2	44.5	1	36	1	6.8	58.4
SMA4F39AH	4F039	43.6	48.2	1	39	1	6.3	63.3
SMA4F40AH	4F040	44.7	49.4	1	40	1	6.2	64.9
SMA4F43AH	4F043	48.1	53.1	1	43	1	5.7	69.8
SMA4F47AH	4F047	52.5	58.1	1	47	1	5.2	76.3
SMA4F51AH	4F051	57.0	63.0	1	51	1	4.8	82.8
SMA4F56AH	4F056	62.6	69.2	1	56	1	4.4	90.9
SMA4F60AH	4F060	67.1	74.1	1	60	1	4.1	97.4

Note:

1. Pulse test with $PW = 30\text{ms}$

ORDERING INFORMATION		
ORDERING CODE⁽¹⁾	PACKAGE	PACKING
SMA4FxxAH	Thin SMA	14,000 / Tape & Reel

Notes:

- (1) "xx" defines voltage from 12V (SMA4F12AH) to 60V (SMA4F60AH)

CHARACTERISTICS CURVES

($T_A = 25^\circ\text{C}$ unless otherwise noted)

Fig.1 Pulse Power or Current vs. Initial Junction Temperature

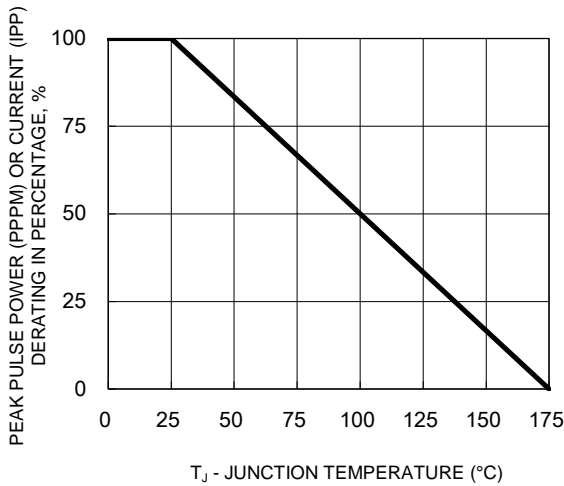

Fig.2 Steady State Power Derating

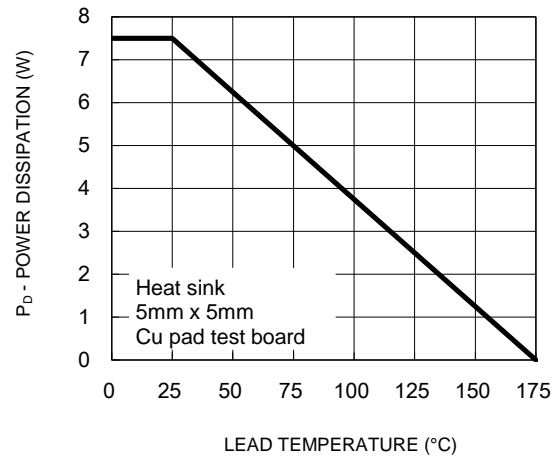

Fig.3 Clamping Power Pulse Waveform

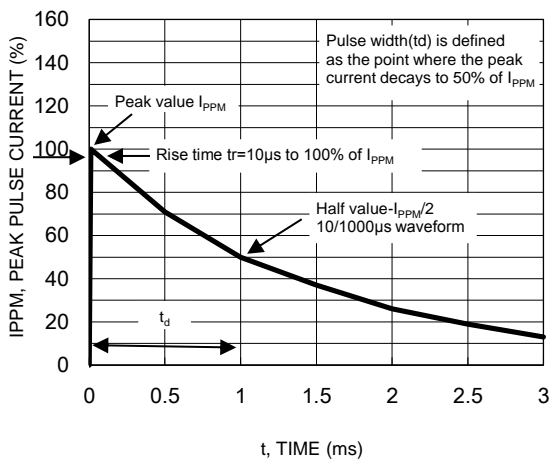

Fig.4 Typical Junction Capacitance

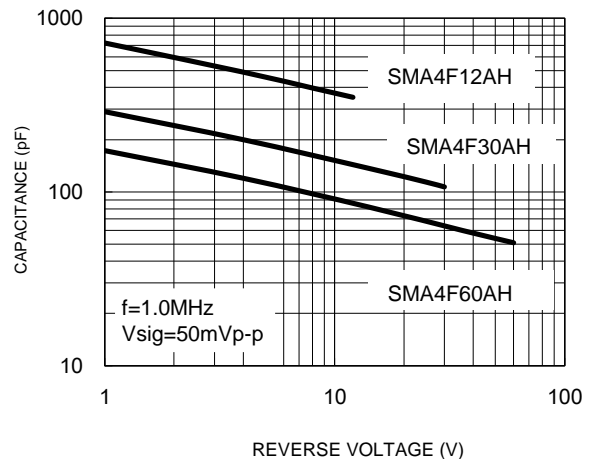
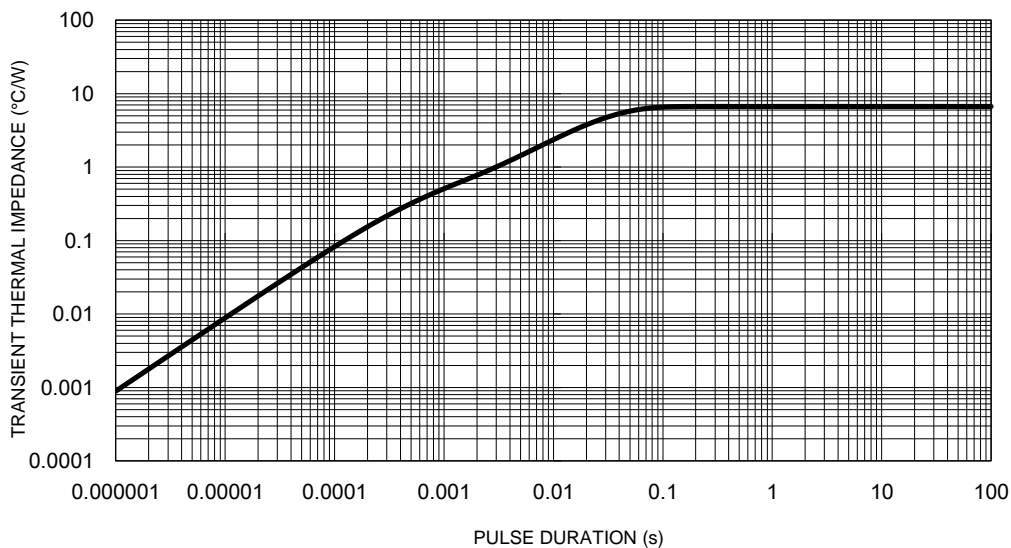
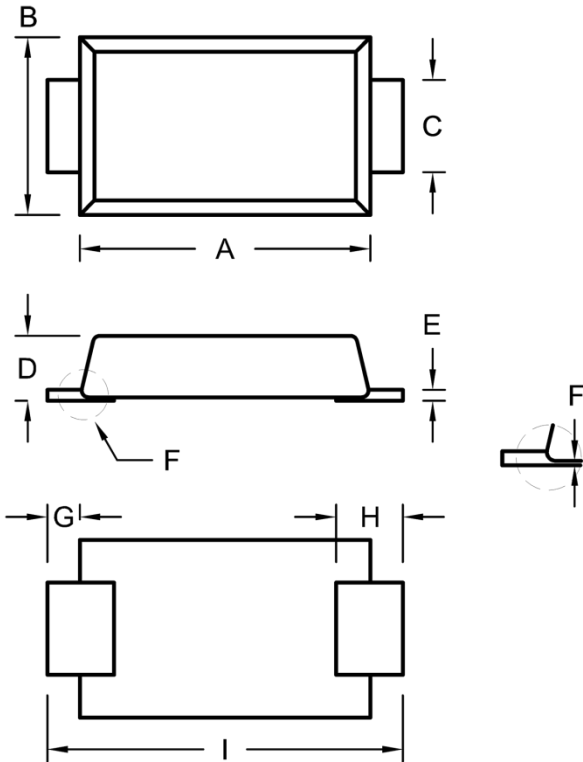

Fig.5 Typical Transient Thermal Impedance



PACKAGE OUTLINE DIMENSIONS

Thin SMA



DIM.	Unit (mm)		Unit (inch)	
	Min.	Max.	Min.	Max.
A	4.15	4.35	0.163	0.171
B	2.50	2.70	0.098	0.106
C	1.25	1.45	0.049	0.057
D	0.90	1.00	0.035	0.039
E	0.10	0.22	0.004	0.009
F	0.00	0.10	0.000	0.004
G	0.30	0.60	0.012	0.024
H	0.75	1.20	0.030	0.047
I	5.05	5.35	0.199	0.211

SUGGESTED PAD LAYOUT

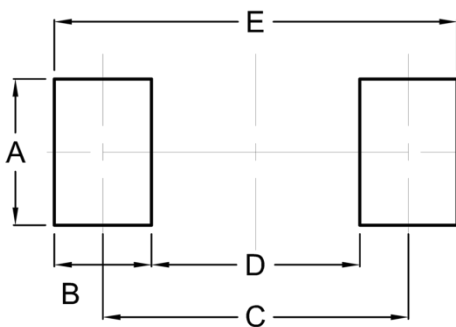

Symbol	Unit (mm)	Unit (inch)
A	2.10	0.083
B	1.40	0.055
C	4.40	0.173
D	3.00	0.118
E	5.80	0.228

MARKING DIAGRAM

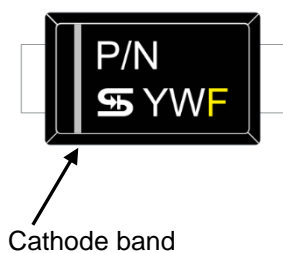

- P/N = Marking Code
- YW = Date Code
- F = Factory Code