

## 400W, 12V - 60V Surface Mount Transient Voltage Suppressor

### FEATURES

- AEC-Q101 qualified
- Glass passivated chip junction
- Maximum  $V_{BR}$  temperature coefficient: 0.095%/°C
- Moisture sensitivity level: level 1, per J-STD-020
- RoHS Compliant
- Halogen-free according to IEC 61249-2-21

### APPLICATIONS

- Switching mode power supply (SMPS)
- Motor for BLDC
- Lighting application
- Battery Management System
- Automotive

### MECHANICAL DATA

- Case: Thin SMA
- Molding compound meets UL 94V-0 flammability rating
- Terminal: Matte tin plated leads, solderable per J-STD-002
- Meet JESD 201 class 2 whisker test
- Polarity: Uni-directional
- Weight: 0.030g (approximately)

| KEY PARAMETERS |             |      |
|----------------|-------------|------|
| PARAMETER      | VALUE       | UNIT |
| $V_{WM}$       | 12 - 60     | V    |
| $V_{BR}$       | 13.4 - 74.1 | V    |
| $P_{PPM}$      | 400         | W    |
| $T_{JMAX}$     | 175         | °C   |
| Package        | Thin SMA    |      |
| Configuration  | Single die  |      |



Thin SMA



| ABSOLUTE MAXIMUM RATINGS ( $T_A = 25^\circ\text{C}$ unless otherwise noted)          |           |             |      |
|--|-----------|-------------|------|
| PARAMETER  | SYMBOL    | VALUE       | UNIT |
| Non-repetitive peak impulse power dissipation with 10/1000us waveform <sup>(1)</sup> | $P_{PPM}$ | 400         | W    |
| Steady state power dissipation at $T_L = 25^\circ\text{C}$ <sup>(2)</sup>            | $P_D$     | 7.5         | W    |
| Forward Voltage @ $I_F = 25\text{A}$ for Uni-directional only <sup>(3)</sup>         | $V_F$     | 3.5         | V    |
| Junction temperature   | $T_J$     | -55 to +175 | °C   |
| Storage temperature  | $T_{STG}$ | -55 to +175 | °C   |

#### Notes:

1. Non-repetitive current pulse per fig.3 and derated above  $T_A = 25^\circ\text{C}$  per fig.1
2. Units mounted on PCB (5mm x 5mm Cu pad test board)
3. Pulse test with  $PW = 0.3\text{ms}$

| <b>THERMAL PERFORMANCE</b>             |                 |            |             |
|--|-----------------|------------|-------------|
| <b>PARAMETER</b>                       | <b>SYMBOL</b>   | <b>TYP</b> | <b>UNIT</b> |
| Junction-to-lead thermal resistance    | $R_{\theta JL}$ | 20         | °C/W        |
| Junction-to-ambient thermal resistance | $R_{\theta JA}$ | 62         | °C/W        |
| Junction-to-case thermal resistance    | $R_{\theta JC}$ | 16         | °C/W        |

**Thermal Performance Note:** Units mounted on PCB (5mm x 5mm Cu pad test board)

| <b>ELECTRICAL SPECIFICATIONS</b> ( $T_A = 25^\circ\text{C}$ unless otherwise noted) |              |   |      |                         |  |  |   |  |
|---|--------------|---|------|-------------------------|--|--|---|--|
| Part number   | Marking code | Breakdown voltage $V_{BR}@I_T$ (V) (Note 1) |      | Test current $I_T$ (mA) | Working stand-off voltage $V_{WM}$ (V) | Maximum blocking leakage current $I_R@V_{WM}$ ( $\mu\text{A}$ ) (Note 1) | Maximum peak impulse current $I_{PPM}$ (A) $t_p = 10/1000\mu\text{s}$ | Maximum clamping voltage $V_C@I_{PPM}$ (V) |
|   |              | Min   | Max  |                         |  |  |   |  |
| SMA4F12AH   | 4F012        | 13.4  | 14.8 | 1                       | 12                                     | 1  | 20.5  | 19.5                                       |
| SMA4F15AH   | 4F015        | 16.8  | 18.5 | 1                       | 15                                     | 1  | 16.4  | 24.4                                       |
| SMA4F18AH   | 4F018        | 20.1  | 22.2 | 1                       | 18                                     | 1  | 13.7  | 29.2                                       |
| SMA4F20AH   | 4F020        | 22.4  | 24.7 | 1                       | 20                                     | 1  | 12.3  | 32.5                                       |
| SMA4F21AH   | 4F021        | 23.5  | 25.9 | 1                       | 21                                     | 1  | 11.7  | 34.1                                       |
| SMA4F22AH   | 4F022        | 24.6  | 27.2 | 1                       | 22                                     | 1  | 11.2  | 35.7                                       |
| SMA4F24AH   | 4F024        | 26.8  | 29.6 | 1                       | 24                                     | 1  | 10.3  | 39.0                                       |
| SMA4F25AH   | 4F025        | 27.9  | 30.9 | 1                       | 25                                     | 1  | 9.9   | 40.6                                       |
| SMA4F26AH   | 4F026        | 29.1  | 32.1 | 1                       | 26                                     | 1  | 9.5   | 42.2                                       |
| SMA4F30AH   | 4F030        | 33.5  | 37.1 | 1                       | 30                                     | 1  | 8.2   | 48.7                                       |
| SMA4F33AH   | 4F033        | 36.9  | 40.8 | 1                       | 33                                     | 1  | 7.5   | 53.6                                       |
| SMA4F36AH   | 4F036        | 40.2  | 44.5 | 1                       | 36                                     | 1  | 6.8   | 58.4                                       |
| SMA4F39AH   | 4F039        | 43.6  | 48.2 | 1                       | 39                                     | 1  | 6.3   | 63.3                                       |
| SMA4F40AH   | 4F040        | 44.7  | 49.4 | 1                       | 40                                     | 1  | 6.2   | 64.9                                       |
| SMA4F43AH   | 4F043        | 48.1  | 53.1 | 1                       | 43                                     | 1  | 5.7   | 69.8                                       |
| SMA4F47AH   | 4F047        | 52.5  | 58.1 | 1                       | 47                                     | 1  | 5.2   | 76.3                                       |
| SMA4F51AH   | 4F051        | 57.0  | 63.0 | 1                       | 51                                     | 1  | 4.8   | 82.8                                       |
| SMA4F56AH   | 4F056        | 62.6  | 69.2 | 1                       | 56                                     | 1  | 4.4   | 90.9                                       |
| SMA4F60AH   | 4F060        | 67.1  | 74.1 | 1                       | 60                                     | 1  | 4.1   | 97.4                                       |

**Note:**

1. Pulse test with  $PW = 30\text{ms}$

| <b>ORDERING INFORMATION</b>        |                |                      |
|------------------------------------|----------------|----------------------|
| <b>ORDERING CODE<sup>(1)</sup></b> | <b>PACKAGE</b> | <b>PACKING</b>       |
| SMA4FxxAH                          | Thin SMA       | 14,000 / Tape & Reel |

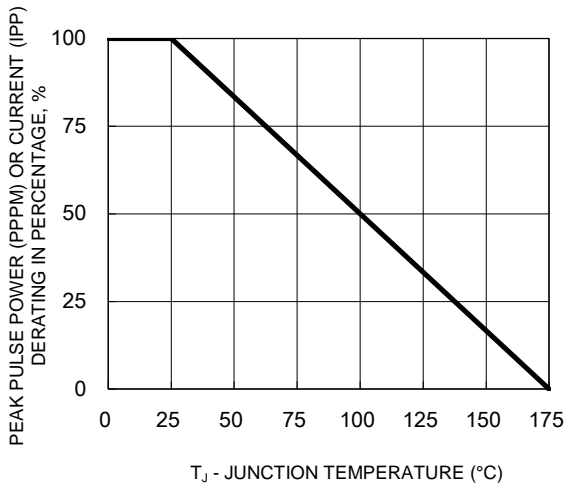
**Notes:**

- (1) "xx" defines voltage from 12V (SMA4F12AH) to 60V (SMA4F60AH)

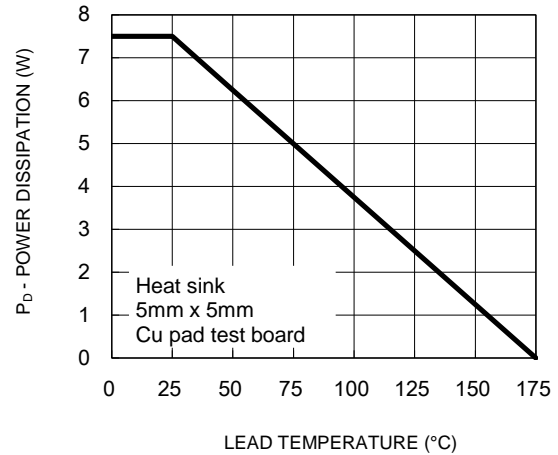
**CHARACTERISTICS CURVES**

( $T_A = 25^\circ\text{C}$  unless otherwise noted)

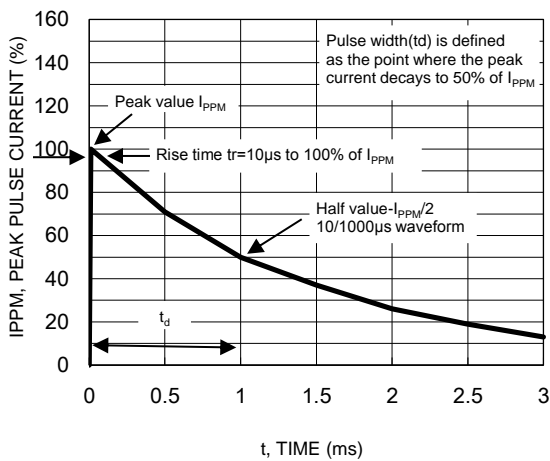
**Fig.1 Pulse Power or Current vs. Initial Junction Temperature**



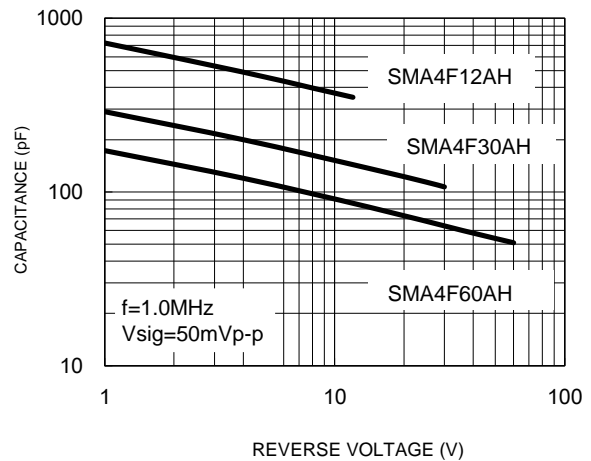
**Fig.2 Steady State Power Derating**



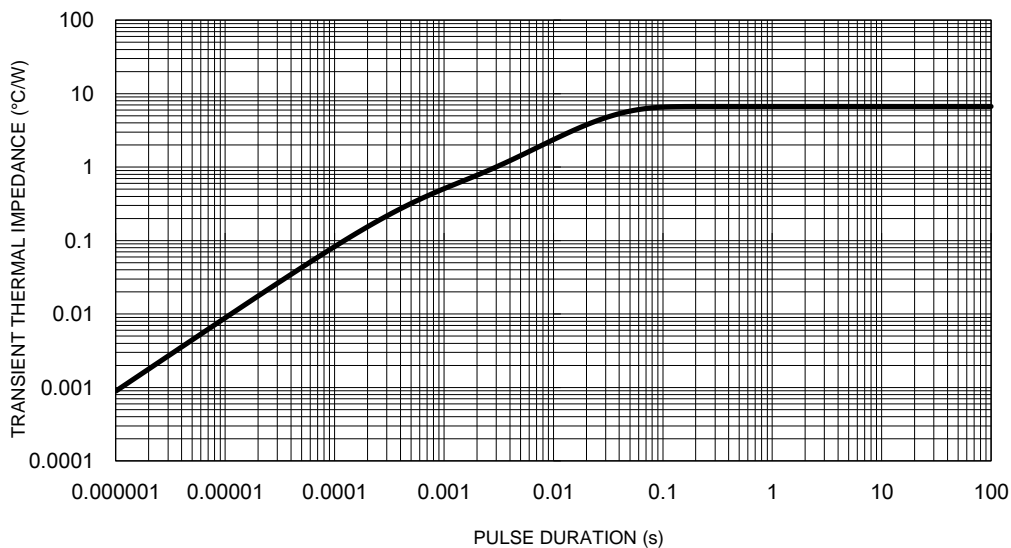
**Fig.3 Clamping Power Pulse Waveform**



**Fig.4 Typical Junction Capacitance**

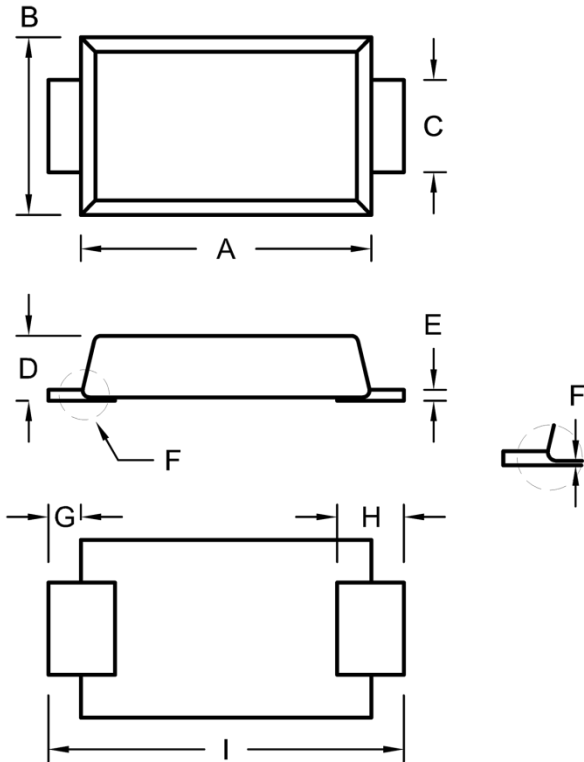


**Fig.5 Typical Transient Thermal Impedance**



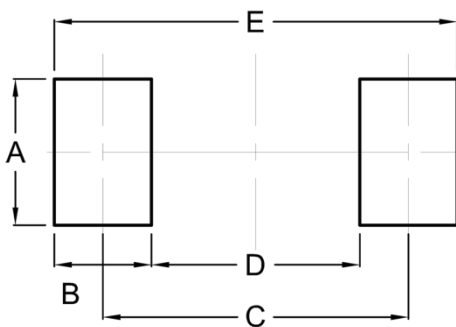
**PACKAGE OUTLINE DIMENSIONS**

Thin SMA



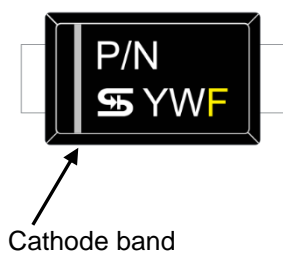
| DIM. | Unit (mm) |      | Unit (inch) |       |
|------|-----------|------|-------------|-------|
|      | Min.      | Max. | Min.        | Max.  |
| A    | 4.15      | 4.35 | 0.163       | 0.171 |
| B    | 2.50      | 2.70 | 0.098       | 0.106 |
| C    | 1.25      | 1.45 | 0.049       | 0.057 |
| D    | 0.90      | 1.00 | 0.035       | 0.039 |
| E    | 0.10      | 0.22 | 0.004       | 0.009 |
| F    | 0.00      | 0.10 | 0.000       | 0.004 |
| G    | 0.30      | 0.60 | 0.012       | 0.024 |
| H    | 0.75      | 1.20 | 0.030       | 0.047 |
| I    | 5.05      | 5.35 | 0.199       | 0.211 |

**SUGGESTED PAD LAYOUT**



| Symbol | Unit (mm) | Unit (inch) |
|--------|-----------|-------------|
| A      | 2.10      | 0.083       |
| B      | 1.40      | 0.055       |
| C      | 4.40      | 0.173       |
| D      | 3.00      | 0.118       |
| E      | 5.80      | 0.228       |

**MARKING DIAGRAM**



- P/N = Marking Code
- YW = Date Code
- F = Factory Code