

5000 W TVS in SMC

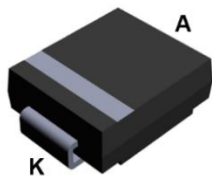
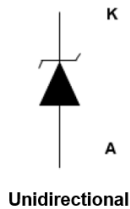

SMC
(JEDEC DO-214AB)

Product status link

[SMC50J5.0A](#), [SMC50J6.0A](#),
[SMC50J6.5A](#), [SMC50J8.5A](#),
[SMC50J10A](#), [SMC50J11A](#),
[SMC50J12A](#), [SMC50J13A](#),
[SMC50J14A](#), [SMC50J15A](#),
[SMC50J16A](#), [SMC50J18A](#),
[SMC50J20A](#), [SMC50J22A](#),
[SMC50J23A](#), [SMC50J24A](#),
[SMC50J26A](#), [SMC50J28A](#),
[SMC50J30A](#), [SMC50J31A](#),
[SMC50J33A](#), [SMC50J36A](#),
[SMC50J40A](#), [SMC50J48A](#),
[SMC50J58A](#), [SMC50J64A](#),
[SMC50J70A](#), [SMC50J85A](#),
[SMC50J100A](#).

Features

- Peak pulse power:
 - 5000 W (10/1000 μ s)
 - up to 48 kW (8/20 μ s)
- Stand-off voltage range from 5 V to 100 V
- Unidirectional type
- Low leakage current: 0.2 μ A at 25 °C
- Operating T_j max: 175 °C
- JEDEC registered package outline
- Resin meets UL94, V0
- Lead finishing: matte tin plating

Complies with the following standards

- UL94, V0
- J-STD-020 MSL level 1
- J-STD-002, JESD 22-B102 E3 and MIL-STD-750, method 2026
- JESD-201 class 2 whisker test
- IPC7531 footprint and JEDEC registered package outline
- IEC 61000-4-4 level 4:
 - 4 kV
- IEC 61000-4-2, C = 150 pF, R = 330 Ω exceeds level 4:
 - 30 kV (air discharge)
 - 30 kV (contact discharge)

Description

The SMC50J TVS series are designed to protect sensitive equipment against electrostatic discharges according to IEC 61000-4-2, MIL STD 883 Method 3015, and electrical overstress such as IEC 61000-4-4 and 5. They are used for surges below 5000 W 10/1000 μ s.

This planar technology makes it compatible with high-end equipment and SMPS where low leakage current and high junction temperature are required to provide reliability and stability over time.

1 Characteristics

Table 1. Absolute maximum ratings ($T_{amb} = 25\text{ }^{\circ}\text{C}$)

Symbol	Parameter	Value	Unit	
V_{PP}	Peak pulse voltage	IEC 61000-4-2 (C = 150 pF, R = 330 Ω)		
		Contact discharge	30	kV
		Air discharge	30	
P_{PP}	Peak pulse power dissipation	T_j initial = T_{amb}	5000	W
T_{stg}	Storage temperature range		-65 to +175	$^{\circ}\text{C}$
T_j	Operating junction temperature range		-55 to +175	$^{\circ}\text{C}$
T_L	Maximum lead temperature for soldering during 10 s		260	$^{\circ}\text{C}$

Figure 1. Electrical characteristics - parameter definitions

- V_{RM} Maximum stand-off voltage
- I_{RM} Maximum leakage current @ V_{RM}
- V_R Stand-off voltage
- I_R Leakage current @ V_R
- V_{BR} Breakdown voltage @ I_{BR}
- I_{BR} Breakdown current
- V_{CL} Clamping voltage @ I_{PP}
- I_{PP} Peak pulse current
- R_D Dynamic resistance
- V_F Forward voltage drop @ I_F
- I_F Forward current
- αT Voltage temperature coefficient

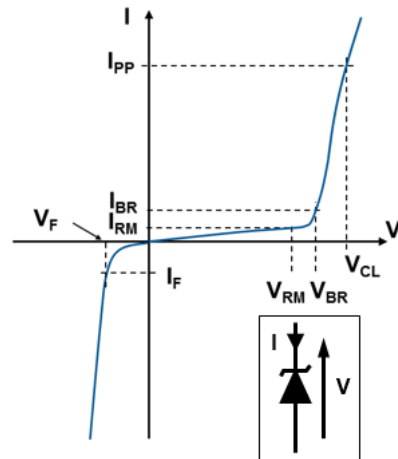

Figure 2. Pulse definition for electrical characteristics

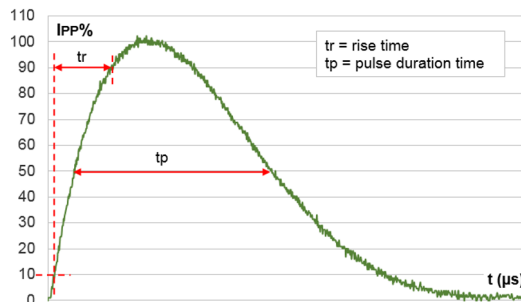

Table 2. Electrical characteristics - parameter values ($T_{amb} = 25\text{ }^{\circ}\text{C}$, unless otherwise specified)

Type	I_{RM} max at V_{RM}			V_{BR} at I_R ⁽¹⁾				10 / 1000 μ s			8 / 20 μ s			αT
	25 $^{\circ}\text{C}$	85 $^{\circ}\text{C}$		Min.	Typ.	Max.		V_{CL} ⁽²⁾⁽³⁾	I_{PP}	R_D	V_{CL} ⁽²⁾⁽³⁾	I_{PP}	R_D	Max.
	μA	μA	V	V	V	V	mA	Max.		Max.	Max.		Max.	Max.
								V	A	m Ω	V	A	m Ω	$10^{-4}/^{\circ}\text{C}$
SMC50J5.0A	20	50	5.0	6.4	6.74	7.1	10	9.2	544	3.86	14.4	2136	3.59	5.7
SMC50J6.0A	20	50	6.0	6.7	7.05	7.4	10	10.3	486	5.97	14.7	2042	3.75	5.9
SMC50J6.5A	20	50	6.5	7.2	7.58	8	10	11.2	447	7.16	15.2	1986	3.84	6.1
SMC50J8.5A	20	50	8.5	9.4	9.9	10.4	1	14.4	348	11.5	18.6	1710	5.09	7.3
SMC50J10A	0.2	1	10	11.1	11.7	12.3	1	17	295	15.9	21.7	1505	6.64	7.8
SMC50J11A	0.2	1	11	12.3	13	13.7	1	18	275	15.6	24.2	1387	8.07	8.1
SMC50J12A	0.2	1	12	13.3	14	14.7	1	19.9	252	20.6	25.3	1309	8.63	8.3
SMC50J13A	0.2	1	13	14.4	15.2	16	1	21.5	233	23.6	27.2	1227	9.78	8.4
SMC50J14A	0.2	1	14	15.7	16.5	17.3	1	23.1	216	26.9	29	1151	10.9	8.6
SMC50J15A	0.2	1	15	16.7	17.6	18.5	1	24.4	205	28.8	32.5	1095	13.6	8.8
SMC50J16A	0.2	1	16	17.9	18.8	19.8	1	26	192	32.3	34.2	1040	14.8	9.0
SMC50J18A	0.2	1	18	20	21.1	22.2	1	29.2	171	40.9	39.3	950	19.2	9.2
SMC50J20A	0.2	1	20	22.2	23.4	24.6	1	32.4	155	50.3	42.8	876	22.1	9.4
SMC50J22A	0.2	1	22	24.4	25.7	27	1	35.5	141	60.3	48.3	815	27.7	9.6
SMC50J23A	0.2	1	23	25.7	27	28.4	1	37.8	135	69.6	49.2	784	28.3	9.6
SMC50J24A	0.2	1	24	26.7	28.1	29.5	1	38.9	129	72.9	50	760	28.8	9.6
SMC50J26A	0.2	1	26	28.9	30.4	31.9	1	42.1	119	85.7	53.5	715	32.3	9.7
SMC50J28A	0.2	1	28	31.1	32.7	34.3	1	45.4	110	100.9	59	675	39.0	9.8
SMC50J30A	0.2	1	30	33.2	35	36.8	1	48.4	103	112.6	64.3	640	45.8	9.9
SMC50J31A	0.2	1	31	34.2	36	37.8	1	50.2	100	124	65	626	46.3	9.9
SMC50J33A	0.2	1	33	36.7	38.6	40.5	1	53.3	94	136	69.7	593	52.4	10.0
SMC50J36A	0.2	1	36	40	42.1	44.2	1	58.1	86	162	76	550	61.6	10.0
SMC50J40A	0.2	1	40	44.4	46.7	49	1	64.5	78	199	84	511	73.0	10.1
SMC50J48A	0.2	1	48	53.2	56	58.8	1	77.4	65	286	100	444	99.1	10.3
SMC50J58A	0.2	1	58	64.6	68	71.4	1	93.6	53	419	121	381	139	10.4
SMC50J64A	0.2	1	64	71.1	74.8	78.6	1	103	47	447	133	353	164	10.4
SMC50J70A	0.2	1	70	77.9	82	86.1	1	113	42	640	146	345	186	10.5
SMC50J85A	0.2	1	85	95	100	105	1	137	32	1000	178	265	294	10.6
SMC50J100A	0.2	1	100	111	117	123	1	179	28	2000	212	227	419	10.7

1. To calculate V_{BR} versus T_j : V_{BR} at $T_j = V_{BR}$ at $25\text{ }^{\circ}\text{C} \times (1 + \alpha T \times (T_j - 25))$
2. To calculate V_{CL} versus T_j : V_{CL} at $T_j = V_{CL}$ at $25\text{ }^{\circ}\text{C} \times (1 + \alpha T \times (T_j - 25))$
3. To calculate V_{CL} max versus $I_{PP\text{appli}}$: $V_{CL\text{max}} = V_{CL} - R_D \times (I_{PP} - I_{PP\text{appli}})$ where $I_{PP\text{appli}}$ is the surge current in the application

1.1 Characteristics (curves)

Figure 3. Maximum peak power dissipation versus initial junction temperature

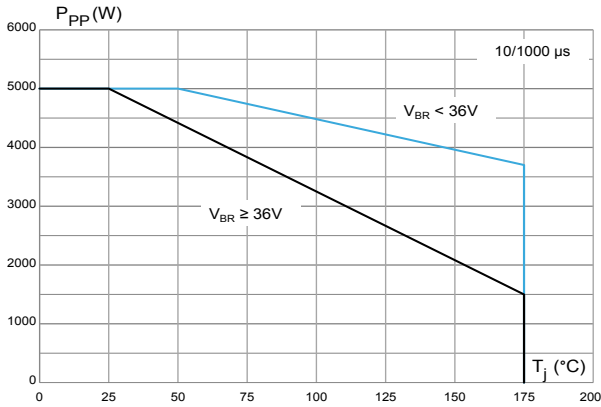

Figure 4. Maximum peak pulse power versus exponential pulse duration

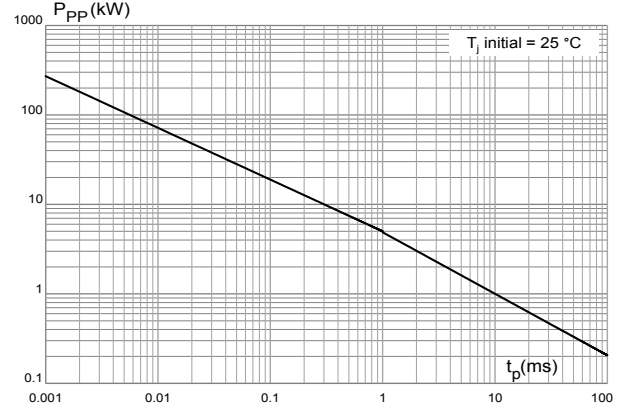

Figure 5. Maximum peak pulse current versus clamping voltage

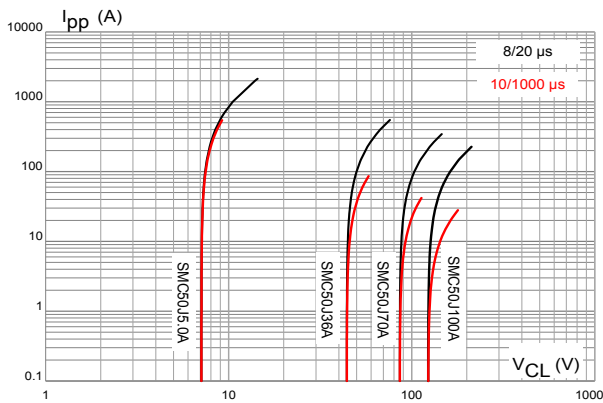

Figure 6. Dynamic resistance versus pulse duration

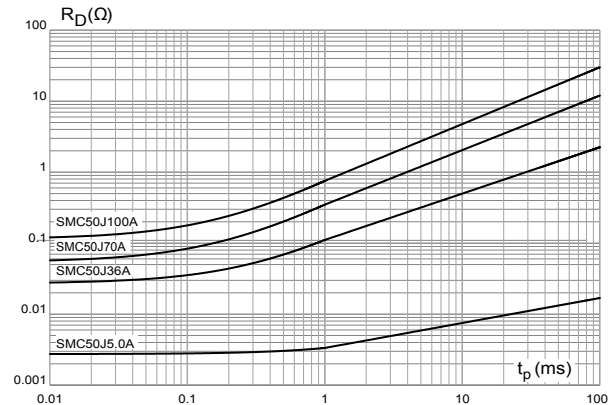

Figure 7. Junction capacitance versus reverse applied voltage (unidirectional type)

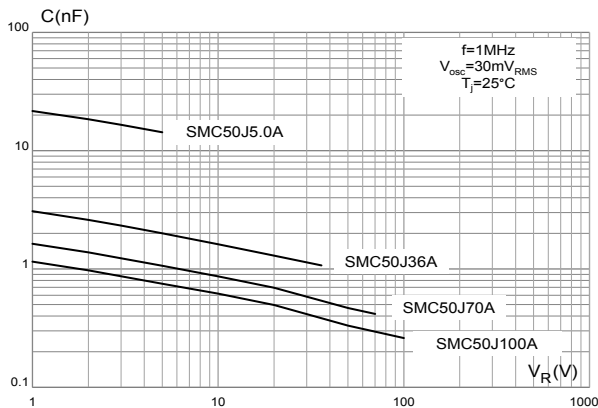

Figure 8. Leakage current versus junction temperature

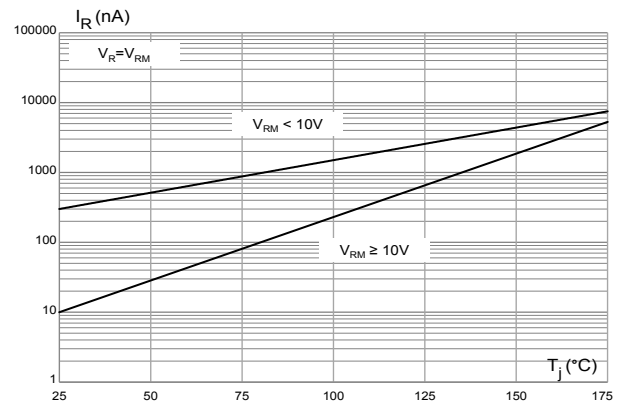

Figure 9. Peak forward voltage drop versus peak forward current

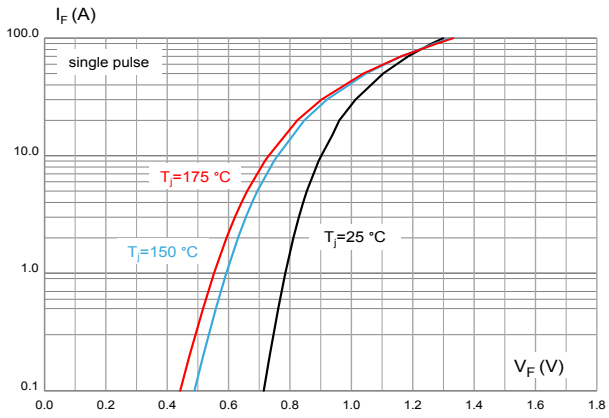

Figure 10. Thermal impedance junction to ambient versus pulse duration

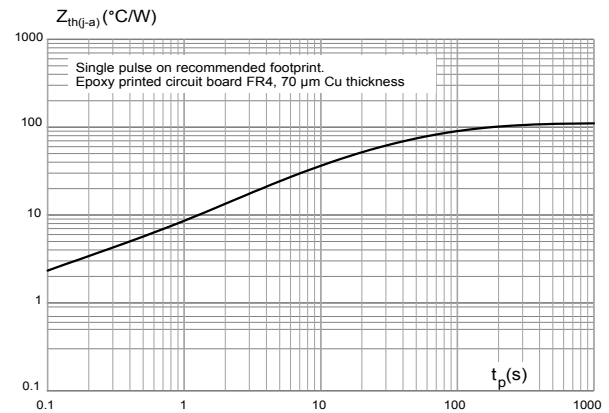
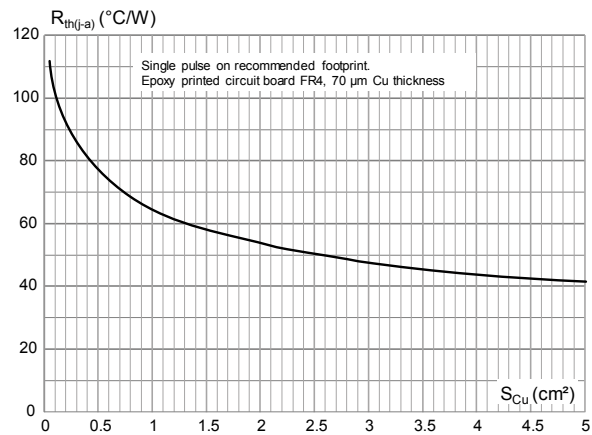

Figure 11. Thermal resistance junction to ambient versus copper area under each lead



2 Package information

In order to meet environmental requirements, ST offers these devices in different grades of **ECOPACK** packages, depending on their level of environmental compliance. ECOPACK specifications, grade definitions and product status are available at: www.st.com. ECOPACK is an ST trademark.

2.1 SMC package information

Figure 12. SMC package outline

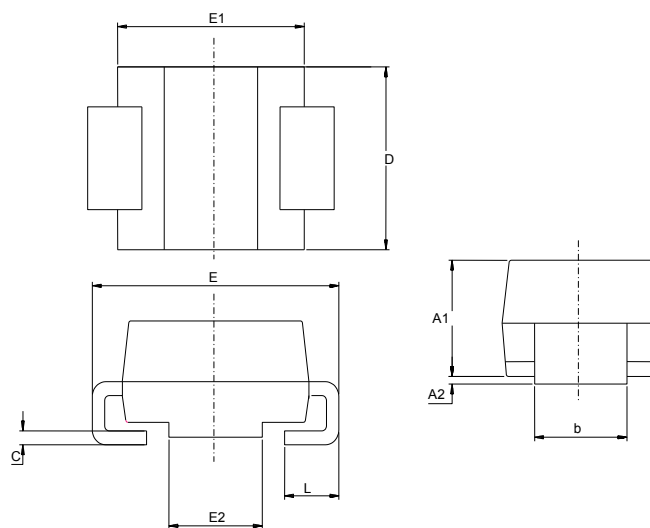

Table 3. SMC package mechanical data

Ref.	Dimensions			
	Millimeters		Inches (for reference only)	
	Min.	Max.	Min.	Max.
A1	1.90	2.45	0.075	0.096
A2	0.05	0.20	0.002	0.008
b	2.90	3.20	0.114	0.126
c	0.15	0.40	0.006	0.016
D	5.55	6.25	0.218	0.246
E	7.75	8.15	0.305	0.321
E1	6.60	7.15	0.260	0.281
E2	4.40	4.70	0.173	0.185
L	0.75	1.50	0.030	0.060

Figure 13. Footprint recommendation

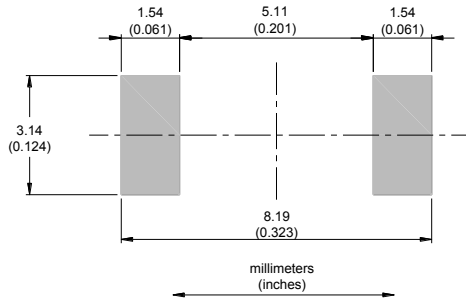

Figure 14. Marking layout

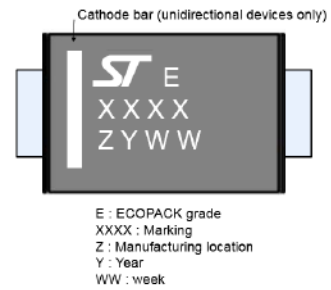
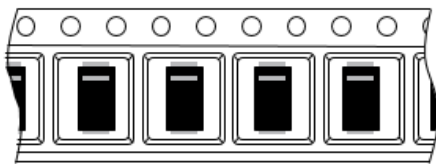

Figure 15. Package orientation in reel



Taped according to EIA-481
Note: Pocket dimensions are not on scale
Pocket shape may vary depending on package

Figure 16. Tape and reel orientation

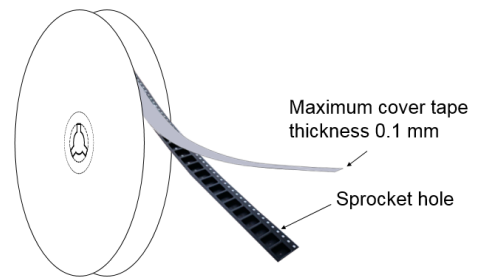

Figure 17. 13" reel dimension values (mm)

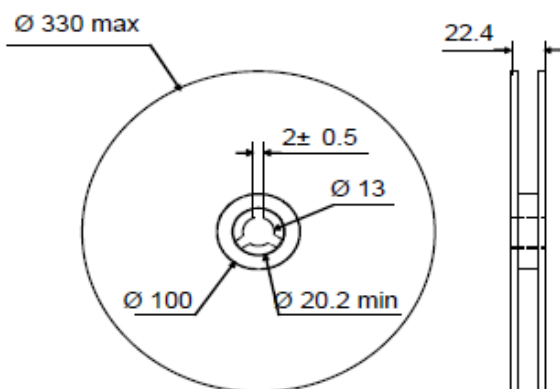

Figure 18. Inner box dimension values (mm)

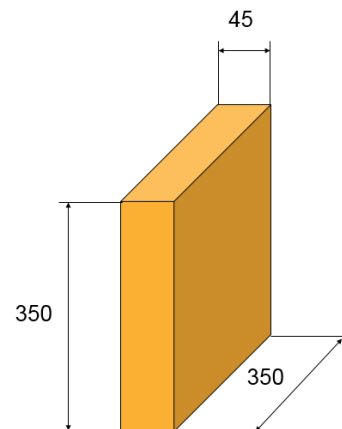
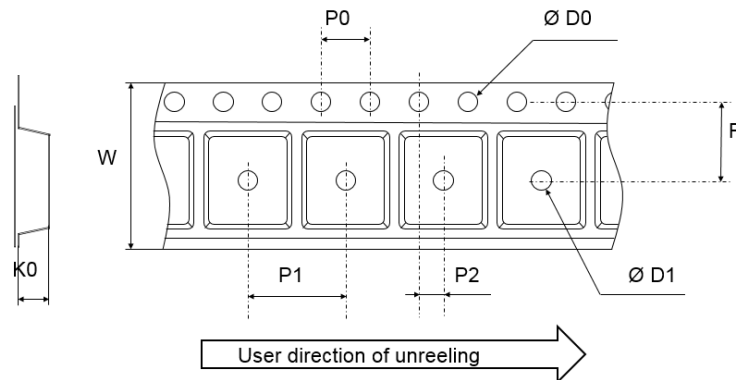

Figure 19. Tape outline



Note: Pocket dimensions are not on scale
Pocket shape may vary depending on package

Table 4. Tape dimension values

Ref.	Dimensions		
	Millimeters		
	Min.	Typ.	Max.
D0	1.4	1.5	1.6
D1	1.5		
F	7.4	7.5	7.6
K0	2.39	2.49	2.59
P0	3.9	4.0	4.1
P1	7.9	8.0	8.1
P2	1.9	2.0	2.1
W	15.7	16	16.3

2.2 Reflow profile

Figure 20. ST ECOPACK recommended soldering reflow profile for PCB mounting

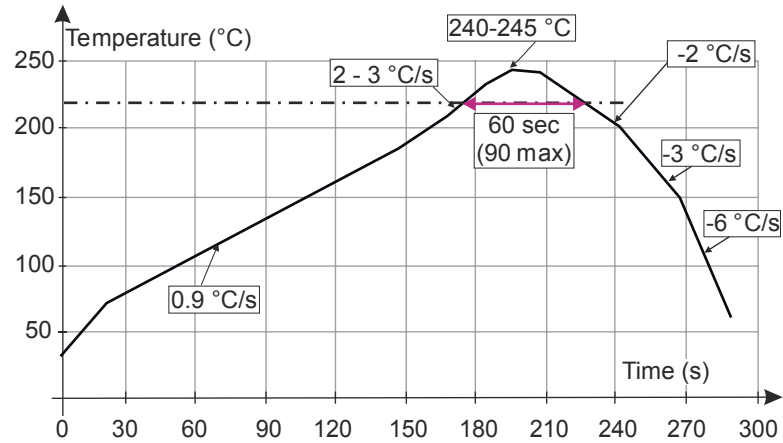

Note: Minimize air convection currents in the reflow oven to avoid component movement. Maximum soldering profile corresponds to the latest IPC/JEDEC J-STD-020.

3 Ordering information

Table 5. Ordering information

Order code	Marking	Package	Weight	Base qty.	Delivery mode
SMC50JxxA ⁽¹⁾	See Table 6. Marking.	SMC	264 mg	2500	Tape and reel

1. Where xx is V_{RM} .

Table 6. Marking

Order code	Marking
SMC50J5.0A	EAI
SMC50J6.0A	EAK
SMC50J6.5A	EAL
SMC50J8.5A	EAP
SMC50J10A	EAS
SMC50J11A	EAU
SMC50J12A	EAW
SMC50J13A	EAY
SMC50J14A	EBA
SMC50J15A	EBC
SMC50J16A	EBE
SMC50J18A	EBI
SMC50J20A	EBM
SMC50J22A	EBO
SMC50J23A	EBP
SMC50J24A	EBQ
SMC50J26A	EBS
SMC50J28A	EBU
SMC50J30A	EBW
SMC50J31A	EBX
SMC50J33A	EBZ
SMC50J36A	ECC
SMC50J40A	ECG
SMC50J48A	ECO
SMC50J58A	ECY
SMC50J64A	EDE
SMC50J70A	EDK
SMC50J85A	EDZ
SMC50J100A	EEO

Revision history

Table 7. Document revision history

Date	Revision	Changes
03-Nov-2021	1	Initial release.