

SMCJ5.0(C)A-HF Thru. SMCJ440(C)A-HF

Working Peak Reverse Voltage: 5.0 to 440 Volts

Power Dissipation: 1500 Watts

RoHS Device

Halogen Free

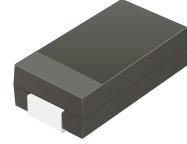

Features

- 1500W peak pulse power capability with a 10/1000 μ s waveform, repetitive rate (duty cycle):0.01%
- For surface mounted applications to optimize board space
- Low incremental surge impedance
- Excellent clamping capability
- Very fast response time
- Uni and Bidirectional unit
- Plastic package has underwriters laboratory flammability 94V-0
- Meet Halogen free and RoHS compliant

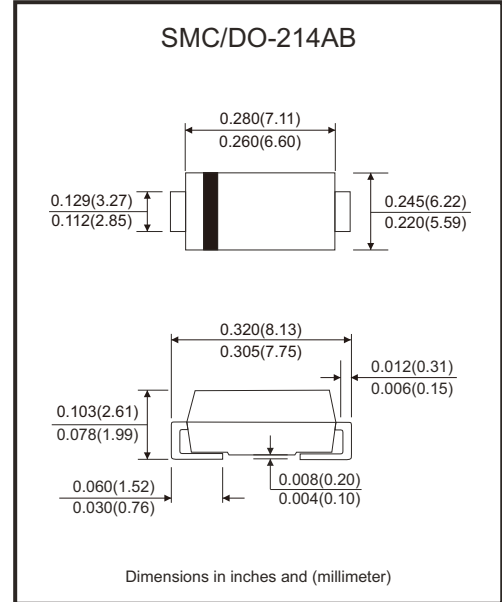

Mechanical data

- Case: SMC/DO-214AB, molded plastic.
- Terminals: solderable per MIL-STD-750, method 2026.
- Polarity: Color band denotes positive end (cathode) except bi-directional models.

Circuit Diagram

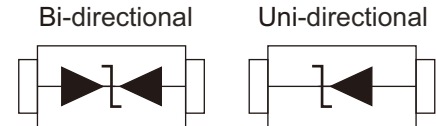

Maximum Ratings and Electrical Characteristics

Rating at 25°C ambient temperature unless otherwise specified.
Single phase, half wave, 60Hz resistive or inductive load. For capacitive load, derate current by 20%.

| Characteristics | Symbol | Value | Units |
|---|-----------------------------------|----------------|-------|
| Peak power dissipation on a 10/1000 μ s waveform (Note 1) | P _{PP} | 1500 | W |
| Peak pulse current on a 10/1000 μ s waveform (Note 1) | I _{PP} | See Next Table | A |
| Steady state power dissipation at T _L =50°C | P _D | 6.5 | W |
| Peak forward surge current, 8.3ms single half sine-wave uni-directional only (Note 2) | I _{FSM} | 200 | A |
| Maximum instantaneous forward voltage at 100A for uni-directional only | V _F | 3.5/5.0 | V |
| Operation junction and storage temperature range | T _J , T _{STG} | -55 to +150 | °C |

- Notes: 1. Non-repetitive current pulse, and derated above T_A=25°C
 2. Mounted on 0.31 x 0.31" (8.0 x 8.0 mm) copper pads to each terminal
 3. V_F<3.5V for devices of V_{BR}<200V and V_F<5.0V for devices of V_{BR}>201V

SMD Transient Voltage Suppressor

Electrical Characteristics (at TA=25°C, unless otherwise specified)

| Part No. | Breakdown voltage VBR @ IT | | | Maximum Reverse Leakage @VRWM IR (µA) | Working Peak Reverse Voltage VRWM (V) | Maximum Reverse Surge Current IPP (A) | Maximum Clamping Voltage @IPP Vc (V) | Marking Code | |
|----------------|-------------------------------|----------|---------|---|--|--|--|--------------|-----|
| | Min. (V) | Max. (V) | IT (mA) | | | | | UNI | BI |
| SMCJ5.0(C)A-HF | 6.40 | 7.25 | 10 | 1000 | 5.0 | 163.0 | 9.2 | GDE | BDE |
| SMCJ6.0(C)A-HF | 6.67 | 7.37 | 10 | 1000 | 6.0 | 145.6 | 10.3 | GDG | BDG |
| SMCJ6.5(C)A-HF | 7.22 | 7.98 | 10 | 500 | 6.5 | 133.9 | 11.2 | GDK | BDK |
| SMCJ7.0(C)A-HF | 7.78 | 8.60 | 10 | 200 | 7.0 | 125.0 | 12.0 | GDM | BDM |
| SMCJ7.5(C)A-HF | 8.33 | 9.21 | 1 | 100 | 7.5 | 116.3 | 12.9 | GDP | BDP |
| SMCJ8.0(C)A-HF | 8.89 | 9.83 | 1 | 50 | 8.0 | 110.3 | 13.6 | GDR | BDR |
| SMCJ8.5(C)A-HF | 9.44 | 10.40 | 1 | 20 | 8.5 | 104.2 | 14.4 | GDT | BDT |
| SMCJ9.0(C)A-HF | 10.00 | 11.10 | 1 | 10 | 9.0 | 97.4 | 15.4 | GDV | BDV |
| SMCJ10(C)A-HF | 11.10 | 12.30 | 1 | 5 | 10.0 | 88.2 | 17.0 | GDX | BDX |
| SMCJ11(C)A-HF | 12.20 | 13.50 | 1 | 5 | 11.0 | 82.4 | 18.2 | GDZ | BDZ |
| SMCJ12(C)A-HF | 13.30 | 14.70 | 1 | 5 | 12.0 | 75.4 | 19.9 | GEE | BEE |
| SMCJ13(C)A-HF | 14.40 | 15.90 | 1 | 5 | 13.0 | 69.8 | 21.5 | GEG | BEG |
| SMCJ14(C)A-HF | 15.60 | 17.20 | 1 | 5 | 14.0 | 64.7 | 23.2 | GEK | BEK |
| SMCJ15(C)A-HF | 16.70 | 18.50 | 1 | 5 | 15.0 | 61.5 | 24.4 | GEM | BEM |
| SMCJ16(C)A-HF | 17.80 | 19.70 | 1 | 5 | 16.0 | 57.7 | 26.0 | GEP | BEP |
| SMCJ17(C)A-HF | 18.90 | 20.90 | 1 | 5 | 17.0 | 54.3 | 27.6 | GER | BER |
| SMCJ18(C)A-HF | 20.00 | 22.10 | 1 | 5 | 18.0 | 51.4 | 29.2 | GET | BET |
| SMCJ20(C)A-HF | 22.20 | 24.50 | 1 | 5 | 20.0 | 46.3 | 32.4 | GEV | BEV |
| SMCJ22(C)A-HF | 24.40 | 26.90 | 1 | 5 | 22.0 | 42.3 | 35.5 | GEX | BEX |
| SMCJ24(C)A-HF | 26.70 | 29.50 | 1 | 5 | 24.0 | 38.6 | 38.9 | GEZ | BEZ |
| SMCJ26(C)A-HF | 28.90 | 31.90 | 1 | 5 | 26.0 | 35.6 | 42.1 | GFE | BFE |
| SMCJ28(C)A-HF | 31.10 | 34.40 | 1 | 5 | 28.0 | 33.0 | 45.4 | GFG | BFG |
| SMCJ30(C)A-HF | 33.30 | 36.80 | 1 | 5 | 30.0 | 31.1 | 48.4 | GFK | BFK |
| SMCJ33(C)A-HF | 36.70 | 40.60 | 1 | 5 | 33.0 | 28.1 | 53.3 | GFM | BFM |
| SMCJ36(C)A-HF | 40.00 | 44.20 | 1 | 5 | 36.0 | 25.8 | 58.1 | GFP | BFP |
| SMCJ40(C)A-HF | 44.40 | 49.10 | 1 | 5 | 40.0 | 23.3 | 64.5 | GFR | BFR |
| SMCJ43(C)A-HF | 47.80 | 52.80 | 1 | 5 | 43.0 | 21.6 | 69.4 | GFT | BFT |
| SMCJ45(C)A-HF | 50.00 | 55.30 | 1 | 5 | 45.0 | 20.6 | 72.7 | GFV | BFV |
| SMCJ48(C)A-HF | 53.30 | 58.90 | 1 | 5 | 48.0 | 19.4 | 77.4 | GFX | BFX |
| SMCJ51(C)A-HF | 56.70 | 62.70 | 1 | 5 | 51.0 | 18.2 | 82.4 | GFZ | BFZ |
| SMCJ54(C)A-HF | 60.00 | 66.30 | 1 | 5 | 54.0 | 17.2 | 87.1 | GGE | BGE |
| SMCJ58(C)A-HF | 64.40 | 71.20 | 1 | 5 | 58.0 | 16.0 | 93.6 | GGG | BGG |
| SMCJ60(C)A-HF | 66.70 | 73.70 | 1 | 5 | 60.0 | 15.5 | 96.8 | GGK | BGK |
| SMCJ64(C)A-HF | 71.10 | 78.60 | 1 | 5 | 64.0 | 14.5 | 103.0 | GGM | BGM |
| SMCJ70(C)A-HF | 77.80 | 86.00 | 1 | 5 | 70.0 | 13.3 | 113.0 | GGP | BGP |
| SMCJ75(C)A-HF | 83.30 | 92.10 | 1 | 5 | 75.0 | 12.4 | 121.0 | GGR | BGR |
| SMCJ78(C)A-HF | 86.70 | 95.80 | 1 | 5 | 78.0 | 11.9 | 126.0 | GGT | BGT |
| SMCJ85(C)A-HF | 94.40 | 104.00 | 1 | 5 | 85.0 | 10.9 | 137.0 | GGV | BGV |
| SMCJ90(C)A-HF | 100.00 | 111.00 | 1 | 5 | 90.0 | 10.3 | 146.0 | GGX | BGX |
| SMCJ100(C)A-HF | 111.00 | 123.00 | 1 | 5 | 100.0 | 9.3 | 162.0 | GGZ | BGZ |

Company reserves the right to improve product design , functions and reliability without notice. REV:A

SMD Transient Voltage Suppressor

Electrical Characteristics (at TA=25°C, unless otherwise specified)

| Part No. | Breakdown voltage VBR @ IT | | | Maximum Reverse Leakage @VRWM IR (μA) | Working Peak Reverse Voltage VRWM (V) | Maximum Reverse Surge Current IPP (A) | Maximum Clamping Voltage @IPP Vc (V) | Marking Code | |
|----------------|-------------------------------|-------------|------------|---|---|---|--|-----------------|-----|
| | Min. (V) | Max. (V) | IT (mA) | | | | | UNI | BI |
| SMCJ110(C)A-HF | 122.0 | 135.0 | 1 | 5 | 110.0 | 8.5 | 177.0 | GHE | BHE |
| SMCJ120(C)A-HF | 133.0 | 147.0 | 1 | 5 | 120.0 | 7.8 | 193.0 | GHG | BHG |
| SMCJ130(C)A-HF | 144.0 | 159.0 | 1 | 5 | 130.0 | 7.2 | 209.0 | GHK | BHK |
| SMCJ150(C)A-HF | 167.0 | 185.0 | 1 | 5 | 150.0 | 6.2 | 243.0 | GHM | BHM |
| SMCJ160(C)A-HF | 178.0 | 197.0 | 1 | 5 | 160.0 | 5.8 | 259.0 | GHP | BHP |
| SMCJ170(C)A-HF | 189.0 | 209.0 | 1 | 5 | 170.0 | 5.4 | 275.0 | GHR | BHR |
| SMCJ180(C)A-HF | 200.0 | 220.0 | 1 | 5 | 180.0 | 5.1 | 291.6 | GHT | BHT |
| SMCJ200(C)A-HF | 224.0 | 247.0 | 1 | 5 | 200.0 | 4.6 | 324.0 | GHV | BHV |
| SMCJ220(C)A-HF | 246.0 | 272.0 | 1 | 5 | 220.0 | 4.2 | 356.0 | GHX | BHX |
| SMCJ250(C)A-HF | 279.0 | 309.0 | 1 | 5 | 250.0 | 3.7 | 405.0 | GHZ | BHZ |
| SMCJ300(C)A-HF | 335.0 | 371.0 | 1 | 5 | 300.0 | 3.1 | 486.0 | GJE | BJE |
| SMCJ350(C)A-HF | 391.0 | 432.0 | 1 | 5 | 350.0 | 2.6 | 567.0 | GJG | BJG |
| SMCJ400(C)A-HF | 447.0 | 494.0 | 1 | 5 | 400.0 | 2.3 | 648.0 | GJK | BJK |
| SMCJ440(C)A-HF | 492.0 | 543.0 | 1 | 5 | 440.0 | 2.1 | 713.0 | GJM | BJM |

Notes: 1. For Bi-directional type having VRWM of 10V and less, the IR Limit is double.
2. For Bi-directional devices, use suffix CA.

Rating and Characteristic Curves (SMCJ5.0(C)A-HF Thru. SMCJ440(C)A-HF)

Fig.1 - Pulse Derating Curve

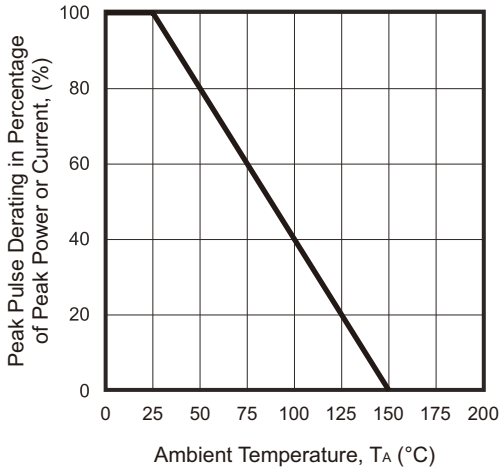

Fig.2 - Maximum Non-Repetitive Surge Current

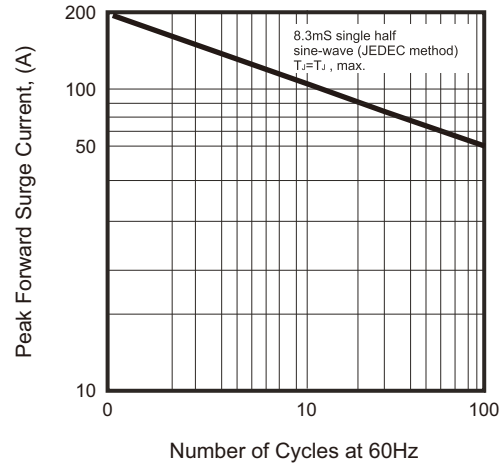

Fig.3 - Steady State Power Derating Curve

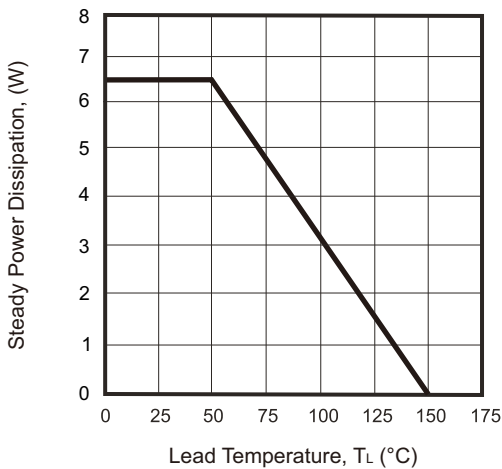

Fig.4 - Peak Pulse Power Rating Curve

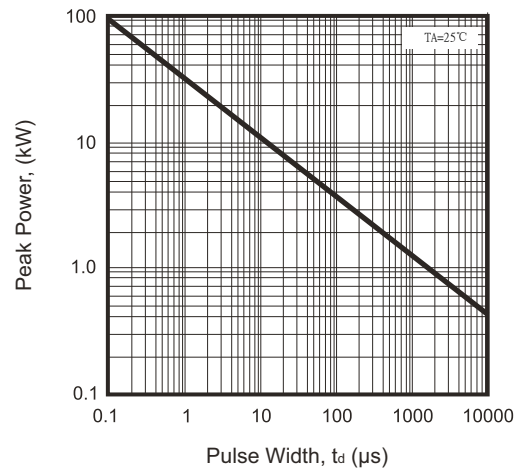
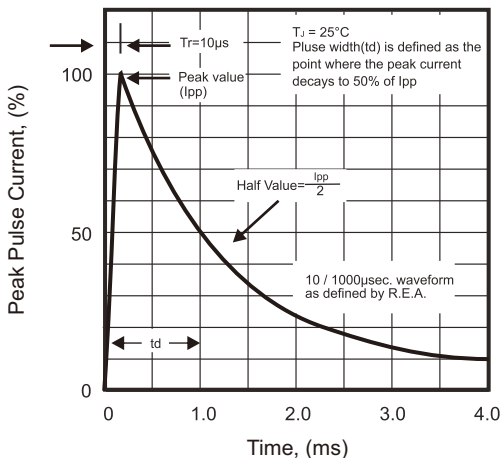
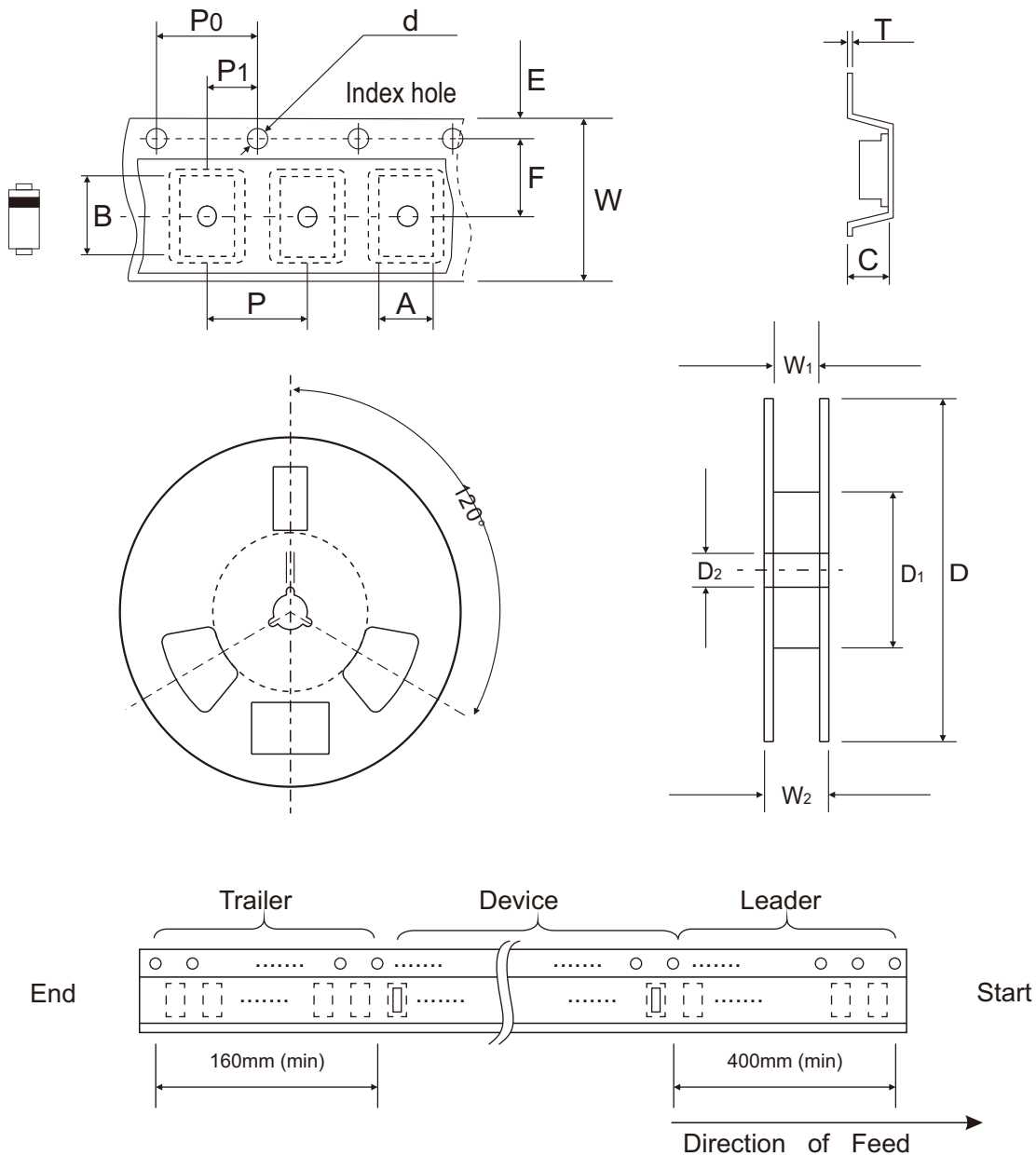

Fig.5 - Pulse Waveform



Reel Taping Specification



| | | | | | | | | | |
|-------------------|--------|---------------|---------------|---------------|----------------|----------------|---------------|---|---|
| DO-214AB (SMC) | SYMBOL | A | B | C | d | T | D | D ₁ | D ₂ |
| | (mm) | See Note 1 | | | 1.55 ± 0.05 | 0.40 (Max.) | 330.00 | 50.00 (Min.) | 13.00 ^{+0.50} _{-0.20} |
| | (inch) | See Note 1 | | | 0.061 ± 0.002 | 0.016 (Max.) | 13.000 | 1.969 (Min.) | 0.512 ^{+0.020} _{-0.008} |
| DO-214AB (SMC) | SYMBOL | E | F | P | P ₀ | P ₁ | W | W ₁ | W ₂ |
| | (mm) | 1.75 ± 0.10 | 7.50 ± 0.05 | 8.00 ± 0.10 | 4.00 ± 0.10 | 2.00 ± 0.05 | 16.00 ± 0.10 | 16.40 ^{+2.00} _{-0.00} | 22.40 (Max.) |
| | (inch) | 0.069 ± 0.004 | 0.295 ± 0.002 | 0.315 ± 0.004 | 0.157 ± 0.004 | 0.079 ± 0.002 | 0.630 ± 0.004 | 0.646 ^{+0.079} _{-0.000} | 0.882 (Max.) |

Notes: 1. A, B, and C the clearance between the component and the cavity must be within 0.5 mm max. for 8 mm tape and 12 mm tape, 1.0 mm max. for 16mm tape and 24 mm tape.

Company reserves the right to improve product design , functions and reliability without notice. REV:A