

SMCJ5.0(C)A-HF Thru. SMCJ440(C)A-HF

Working Peak Reverse Voltage: 5.0 to 440 Volts

Power Dissipation: 1500 Watts

RoHS Device

Halogen Free

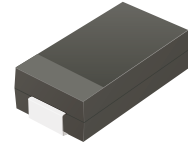

Features

- 1500W peak pulse power capability with a 10/1000 μ s waveform, repetitive rate (duty cycle):0.01%
- For surface mounted applications to optimize board space
- Low incremental surge impedance
- Excellent clamping capability
- Very fast response time
- Uni and Bidirectional unit
- Plastic package has underwriters laboratory flammability 94V-0
- Meet Halogen free and RoHS compliant

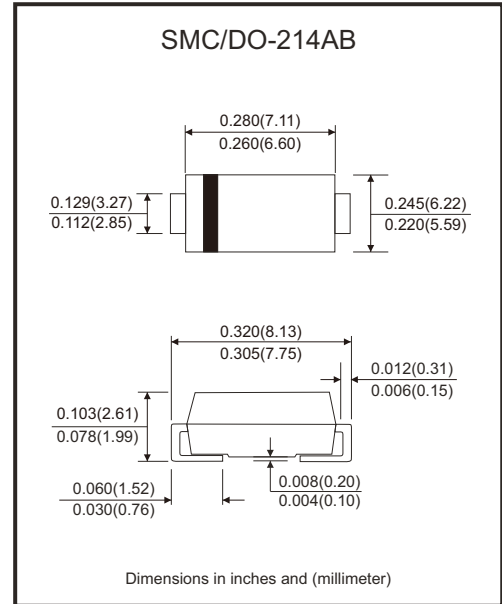

Mechanical data

- Case: SMC/DO-214AB, molded plastic.
- Terminals: solderable per MIL-STD-750, method 2026.
- Polarity: Color band denotes positive end (cathode) except bi-directional models.

Circuit Diagram

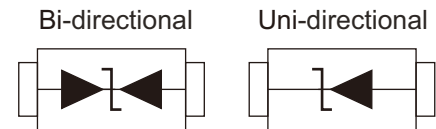

Maximum Ratings and Electrical Characteristics

Rating at 25°C ambient temperature unless otherwise specified.
Single phase, half wave, 60Hz resistive or inductive load. For capacitive load, derate current by 20%.

Characteristics	Symbol	Value	Units
Peak power dissipation on a 10/1000 μ s waveform (Note 1)	P _{PP}	1500	W
Peak pulse current on a 10/1000 μ s waveform (Note 1)	I _{PP}	See Next Table	A
Steady state power dissipation at T _L =50°C	P _D	6.5	W
Peak forward surge current, 8.3ms single half sine-wave uni-directional only (Note 2)	I _{FSM}	200	A
Maximum instantaneous forward voltage at 100A for uni-directional only	V _F	3.5/5.0	V
Operation junction and storage temperature range	T _J , T _{STG}	-55 to +150	°C

- Notes: 1. Non-repetitive current pulse, and derated above T_A=25°C
 2. Mounted on 0.31 x 0.31" (8.0 x 8.0 mm) copper pads to each terminal
 3. V_F<3.5V for devices of VBR<200V and V_F<5.0V for devices of VBR>201V

SMD Transient Voltage Suppressor

Electrical Characteristics (at TA=25°C, unless otherwise specified)

Part No.	Breakdown voltage VBR @ IT			Maximum Reverse Leakage @VRWM IR (µA)	Working Peak Reverse Voltage VRWM (V)	Maximum Reverse Surge Current IPP (A)	Maximum Clamping Voltage @IPP Vc (V)	Marking Code	
	Min. (V)	Max. (V)	IT (mA)					UNI	BI
SMCJ5.0(C)A-HF	6.40	7.25	10	1000	5.0	163.0	9.2	GDE	BDE
SMCJ6.0(C)A-HF	6.67	7.37	10	1000	6.0	145.6	10.3	GDG	BDG
SMCJ6.5(C)A-HF	7.22	7.98	10	500	6.5	133.9	11.2	GDK	BDK
SMCJ7.0(C)A-HF	7.78	8.60	10	200	7.0	125.0	12.0	GDM	BDM
SMCJ7.5(C)A-HF	8.33	9.21	1	100	7.5	116.3	12.9	GDP	BDP
SMCJ8.0(C)A-HF	8.89	9.83	1	50	8.0	110.3	13.6	GDR	BDR
SMCJ8.5(C)A-HF	9.44	10.40	1	20	8.5	104.2	14.4	GDT	BDT
SMCJ9.0(C)A-HF	10.00	11.10	1	10	9.0	97.4	15.4	GDV	BDV
SMCJ10(C)A-HF	11.10	12.30	1	5	10.0	88.2	17.0	GDX	BDX
SMCJ11(C)A-HF	12.20	13.50	1	5	11.0	82.4	18.2	GDZ	BDZ
SMCJ12(C)A-HF	13.30	14.70	1	5	12.0	75.4	19.9	GEE	BEE
SMCJ13(C)A-HF	14.40	15.90	1	5	13.0	69.8	21.5	GEG	BEG
SMCJ14(C)A-HF	15.60	17.20	1	5	14.0	64.7	23.2	GEK	BEK
SMCJ15(C)A-HF	16.70	18.50	1	5	15.0	61.5	24.4	GEM	BEM
SMCJ16(C)A-HF	17.80	19.70	1	5	16.0	57.7	26.0	GEP	BEP
SMCJ17(C)A-HF	18.90	20.90	1	5	17.0	54.3	27.6	GER	BER
SMCJ18(C)A-HF	20.00	22.10	1	5	18.0	51.4	29.2	GET	BET
SMCJ20(C)A-HF	22.20	24.50	1	5	20.0	46.3	32.4	GEV	BEV
SMCJ22(C)A-HF	24.40	26.90	1	5	22.0	42.3	35.5	GEX	BEX
SMCJ24(C)A-HF	26.70	29.50	1	5	24.0	38.6	38.9	GEZ	BEZ
SMCJ26(C)A-HF	28.90	31.90	1	5	26.0	35.6	42.1	GFE	BFE
SMCJ28(C)A-HF	31.10	34.40	1	5	28.0	33.0	45.4	GFG	BFG
SMCJ30(C)A-HF	33.30	36.80	1	5	30.0	31.1	48.4	GFK	BFK
SMCJ33(C)A-HF	36.70	40.60	1	5	33.0	28.1	53.3	GFM	BFM
SMCJ36(C)A-HF	40.00	44.20	1	5	36.0	25.8	58.1	GFP	BFP
SMCJ40(C)A-HF	44.40	49.10	1	5	40.0	23.3	64.5	GFR	BFR
SMCJ43(C)A-HF	47.80	52.80	1	5	43.0	21.6	69.4	GFT	BFT
SMCJ45(C)A-HF	50.00	55.30	1	5	45.0	20.6	72.7	GFV	BFV
SMCJ48(C)A-HF	53.30	58.90	1	5	48.0	19.4	77.4	GFX	BFX
SMCJ51(C)A-HF	56.70	62.70	1	5	51.0	18.2	82.4	GFZ	BFZ
SMCJ54(C)A-HF	60.00	66.30	1	5	54.0	17.2	87.1	GGE	BGE
SMCJ58(C)A-HF	64.40	71.20	1	5	58.0	16.0	93.6	GGG	BGG
SMCJ60(C)A-HF	66.70	73.70	1	5	60.0	15.5	96.8	GGK	BGK
SMCJ64(C)A-HF	71.10	78.60	1	5	64.0	14.5	103.0	GGM	BGM
SMCJ70(C)A-HF	77.80	86.00	1	5	70.0	13.3	113.0	GGP	BGP
SMCJ75(C)A-HF	83.30	92.10	1	5	75.0	12.4	121.0	GGR	BGR
SMCJ78(C)A-HF	86.70	95.80	1	5	78.0	11.9	126.0	GGT	BGT
SMCJ85(C)A-HF	94.40	104.00	1	5	85.0	10.9	137.0	GGV	BGV
SMCJ90(C)A-HF	100.00	111.00	1	5	90.0	10.3	146.0	GGX	BGX
SMCJ100(C)A-HF	111.00	123.00	1	5	100.0	9.3	162.0	GGZ	BGZ

Company reserves the right to improve product design , functions and reliability without notice. REV:A

SMD Transient Voltage Suppressor

Electrical Characteristics (at TA=25°C, unless otherwise specified)

Part No.	Breakdown voltage VBR @ IT			Maximum Reverse Leakage @VRWM IR (μA)	Working Peak Reverse Voltage VRWM (V)	Maximum Reverse Surge Current IPP (A)	Maximum Clamping Voltage @IPP Vc (V)	Marking Code	
	Min. (V)	Max. (V)	IT (mA)					UNI	BI
SMCJ110(C)A-HF	122.0	135.0	1	5	110.0	8.5	177.0	GHE	BHE
SMCJ120(C)A-HF	133.0	147.0	1	5	120.0	7.8	193.0	GHG	BHG
SMCJ130(C)A-HF	144.0	159.0	1	5	130.0	7.2	209.0	GHK	BHK
SMCJ150(C)A-HF	167.0	185.0	1	5	150.0	6.2	243.0	GHM	BHM
SMCJ160(C)A-HF	178.0	197.0	1	5	160.0	5.8	259.0	GHP	BHP
SMCJ170(C)A-HF	189.0	209.0	1	5	170.0	5.4	275.0	GHR	BHR
SMCJ180(C)A-HF	200.0	220.0	1	5	180.0	5.1	291.6	GHT	BHT
SMCJ200(C)A-HF	224.0	247.0	1	5	200.0	4.6	324.0	GHV	BHV
SMCJ220(C)A-HF	246.0	272.0	1	5	220.0	4.2	356.0	GHX	BHX
SMCJ250(C)A-HF	279.0	309.0	1	5	250.0	3.7	405.0	GHZ	BHZ
SMCJ300(C)A-HF	335.0	371.0	1	5	300.0	3.1	486.0	GJE	BJE
SMCJ350(C)A-HF	391.0	432.0	1	5	350.0	2.6	567.0	GJG	BJG
SMCJ400(C)A-HF	447.0	494.0	1	5	400.0	2.3	648.0	GJK	BJK
SMCJ440(C)A-HF	492.0	543.0	1	5	440.0	2.1	713.0	GJM	BJM

Notes: 1. For Bi-directional type having VRWM of 10V and less, the IR Limit is double.
2. For Bi-directional devices, use suffix CA.

Rating and Characteristic Curves (SMCJ5.0(C)A-HF Thru. SMCJ440(C)A-HF)

Fig.1 - Pulse Derating Curve

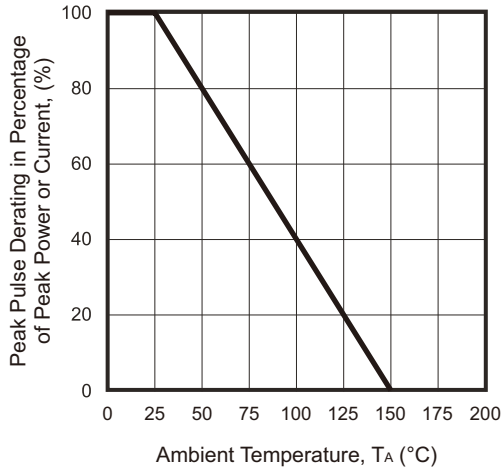

Fig.2 - Maximum Non-Repetitive Surge Current

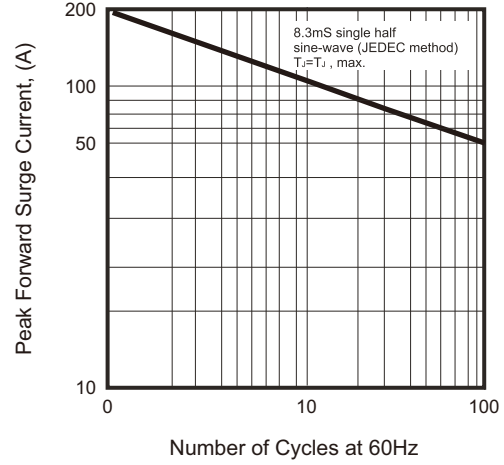

Fig.3 - Steady State Power Derating Curve

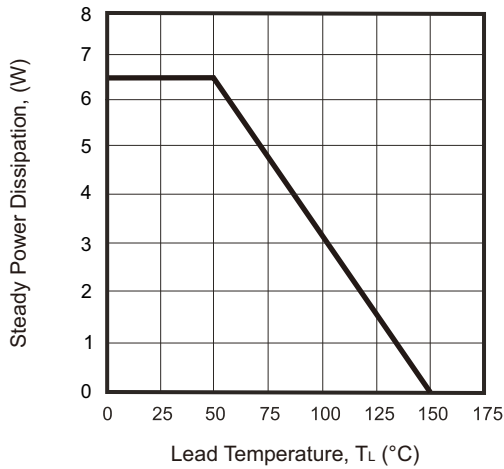

Fig.4 - Peak Pulse Power Rating Curve

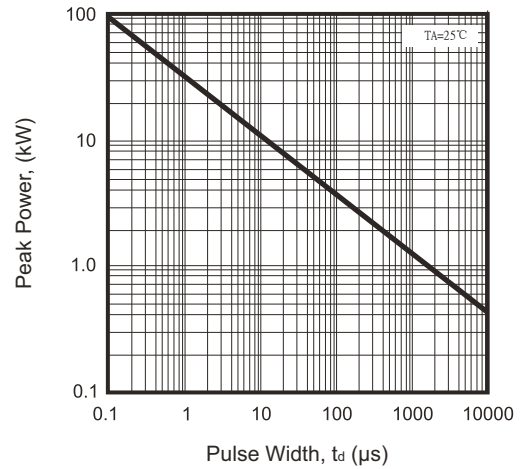
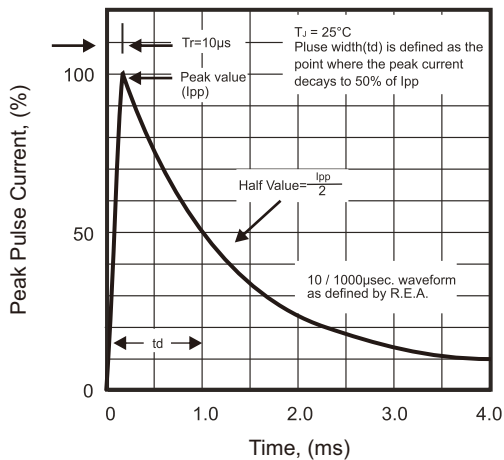
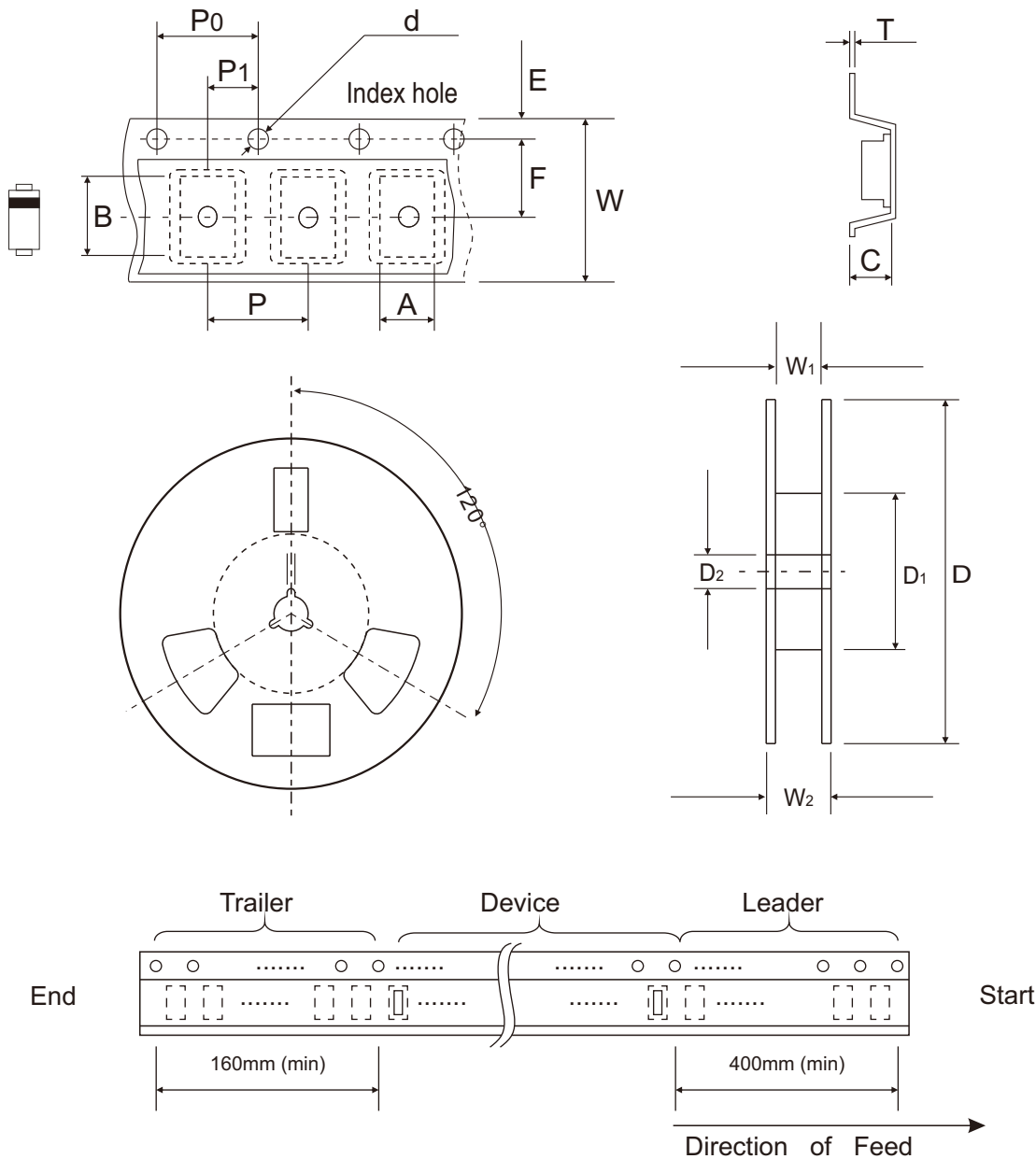

Fig.5 - Pulse Waveform



Reel Taping Specification



DO-214AB (SMC)	SYMBOL	A	B	C	d	T	D	D ₁	D ₂
	(mm)	See Note 1			1.55 ± 0.05	0.40 (Max.)	330.00	50.00 (Min.)	13.00 ^{+0.50} _{-0.20}
	(inch)	See Note 1			0.061 ± 0.002	0.016 (Max.)	13.000	1.969 (Min.)	0.512 ^{+0.020} _{-0.008}
DO-214AB (SMC)	SYMBOL	E	F	P	P ₀	P ₁	W	W ₁	W ₂
	(mm)	1.75 ± 0.10	7.50 ± 0.05	8.00 ± 0.10	4.00 ± 0.10	2.00 ± 0.05	16.00 ± 0.10	16.40 ^{+2.00} _{-0.00}	22.40 (Max.)
	(inch)	0.069 ± 0.004	0.295 ± 0.002	0.315 ± 0.004	0.157 ± 0.004	0.079 ± 0.002	0.630 ± 0.004	0.646 ^{+0.079} _{-0.000}	0.882 (Max.)

Notes: 1. A, B, and C the clearance between the component and the cavity must be within 0.5 mm max. for 8 mm tape and 12 mm tape, 1.0 mm max. for 16mm tape and 24 mm tape.

Company reserves the right to improve product design , functions and reliability without notice. REV:A