



SMF5.0A-AU SERIES

SURFACE MOUNT TRANSIENT VOLTAGE SUPPRESSOR

VOLTAGE 5 to 70 Volt **POWER** 200 Watt

SOD-123FL Unit : inch(mm)

FEATURES

- For surface mounted applications in order to optimize board space.
- Ultra thin profile package for space constrained utilization
- Package suitable for Automated Handling
- Low inductance
- High temperature soldering : 260°C/10 seconds at terminals
- ESD IEC-61000-4-2 Air ± 30kV, Contact ± 30kV
- AEC-Q101 qualified
- Lead free in compliance with EU RoHS 2.0
- Green molding compound as per IEC 61249 standard

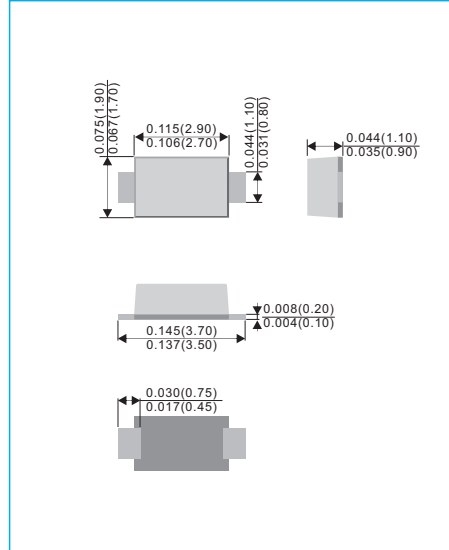

MECHANICAL DATA

- Case: SOD-123FL, Plastic
- Terminals: Solderable per MIL-STD-750, Method 2026
- Polarity: Color band denotes cathode end
- Weight: 0.0006 ounces, 0.0173 grams
- Standard Packaging: 8mm tape (EIA-481)

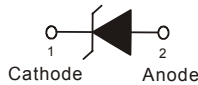

MAXIMUM RATINGS AND ELECTRICAL CHARACTERISTICS (T_A=25°C unless otherwise noted)

PARAMETER	SYMBOL	VALUE	UNITS
Peak Pulse Power Dissipation on T _A = 25°C (Notes 1,2,5, Fig.1)	PPPM	200	W
Peak Forward Surge Current per (Notes 3)	I _{FSM}	20	A
Peak Pulse Current on tp=10/1000µs waveform (Notes 1) Fig.2	I _{PPM}	see Table 1	A
Steady State Power Dissipation (Notes 4)	P _{M(AV)}	1	W
ESD IEC-61000-4-2 (Air) ESD IEC-61000-4-2 (Contact)	V _{ESD}	±30 ±30	kV
Operating Junction and Storage Temperature Range	T _J , T _{STG}	-55 to +150	°C
Typical thermal resistance	R _{θJA}	180	°C

NOTES :

1. Non-repetitive current pulse, per Fig.3 and derated above T_A=25°C per Fig.2 .
2. Mounted on 5mm² copper pads to each terminal.
3. 8.3ms single half sine-wave, or equivalent square wave, duty cycle = 4 pulses per minutes maximum.
4. Lead temperature at 75°C = T_L .
5. Peak pulse power waveform is tp=10/1000µs.
6. A transient suppressor is selected according to the working peak reverse voltage(V_{RWM}), which should be equal to or greater than the DC or continuous peak operating voltage level.



SMF5.0A-AU SERIES

Part Number	V _{RWM} (Note 6)	V _{BR} @ I _T			I _R @ V _{RWM}	V _C @ I _{PP}		Marking Code
		Min.	Max.	I _T		V	A	
	V	V	V	mA	μA			
200W Transient Voltage Suppressor								
SMF5.0A-AU	5	6.4	7	10	200	9.2	21.7	HE
SMF6.0A-AU	6	6.7	7.4	10	100	10.3	19.4	HG
SMF6.5A-AU	6.5	7.2	8	10	75	11.2	17.9	HK
SMF7.0A-AU	7	7.8	8.6	10	50	12	16.7	HM
SMF7.5A-AU	7.5	8.3	9.2	1	50	12.9	15.5	HP
SMF8.0A-AU	8	8.9	9.8	1	25	13.6	14.7	HR
SMF8.5A-AU	8.5	9.4	10.4	1	10	14.4	13.9	HT
SMF9.0A-AU	9	10	11.1	1	5	15.4	13	HV
SMF10A-AU	10	11.1	12.3	1	2.5	17	11.8	HX
SMF11A-AU	11	12.2	13.5	1	2.5	18.2	11	HZ
SMF12A-AU	12	13.3	14.7	1	2.5	19.9	10.1	IE
SMF13A-AU	13	14.4	15.9	1	1	21.5	9.3	IG
SMF14A-AU	14	15.6	17.2	1	1	23.2	8.6	IK
SMF15A-AU	15	16.7	18.5	1	1	24.4	8.2	IM
SMF16A-AU	16	17.8	19.7	1	1	26	7.7	IP
SMF17A-AU	17	18.9	20.9	1	1	27.6	7.2	IR
SMF18A-AU	18	20	22.1	1	1	29.2	6.8	IT
SMF20A-AU	20	22.2	24.5	1	1	32.4	6.2	IV
SMF22A-AU	22	24.4	26.9	1	1	35.5	5.6	IX
SMF24A-AU	24	26.7	29.5	1	1	38.9	5.1	IZ
SMF26A-AU	26	28.9	31.9	1	1	42.1	4.8	JE
SMF28A-AU	28	31.1	34.4	1	1	45.4	4.4	JG
SMF30A-AU	30	33.3	36.8	1	1	48.4	4.1	JK
SMF33A-AU	33	36.7	40.6	1	1	53.3	3.8	JM
SMF36A-AU	36	40	44.2	1	1	58.1	3.4	JP
SMF40A-AU	40	44.4	49.1	1	1	64.5	3.1	JR
SMF43A-AU	43	47.8	52.8	1	1	69.4	2.9	JT
SMF45A-AU	45	50	55.3	1	1	72.7	2.8	JV
SMF48A-AU	48	53.3	58.9	1	1	77.4	2.6	JX
SMF51A-AU	51	56.7	62.7	1	1	82.4	2.4	JZ
SMF54A-AU	54	60	66.3	1	1	87.1	2.3	RE
SMF58A-AU	58	64.4	71.2	1	1	93.6	2.1	RG
SMF60A-AU	60	66.7	73.7	1	1	96.8	1.8	RK
SMF64A-AU	64	71.1	78.6	1	1	103	1.7	RM
SMF70A-AU	70	77.8	86	1	1	113	1.5	RP



SMF5.0A-AU SERIES

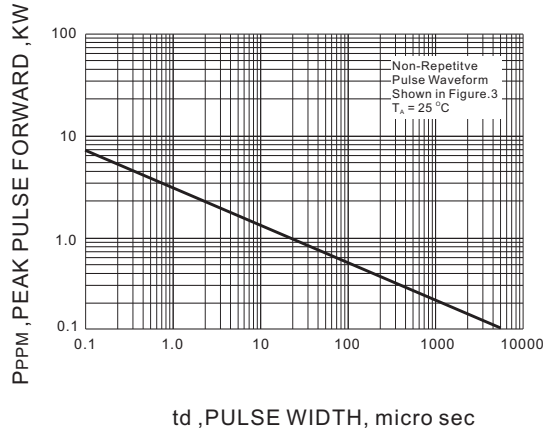

Fig.1 PEAK PULSE POWER RATING CURVE

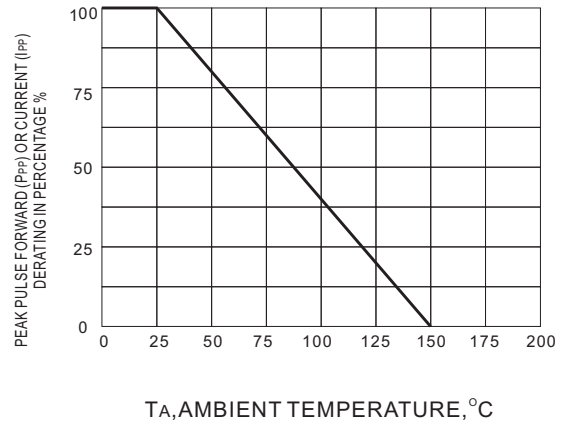

Fig.2 DERATING CURVE

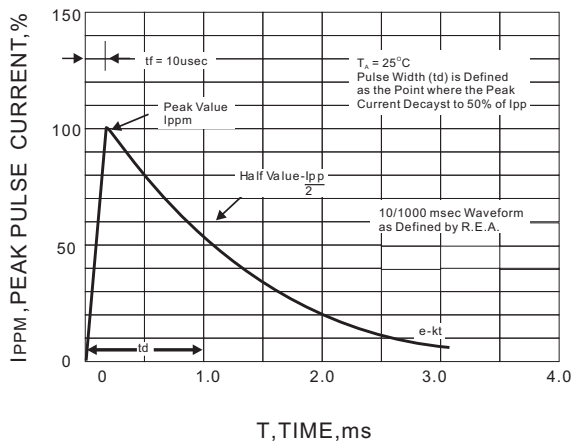

Fig.3 PULSE WAVEFORM

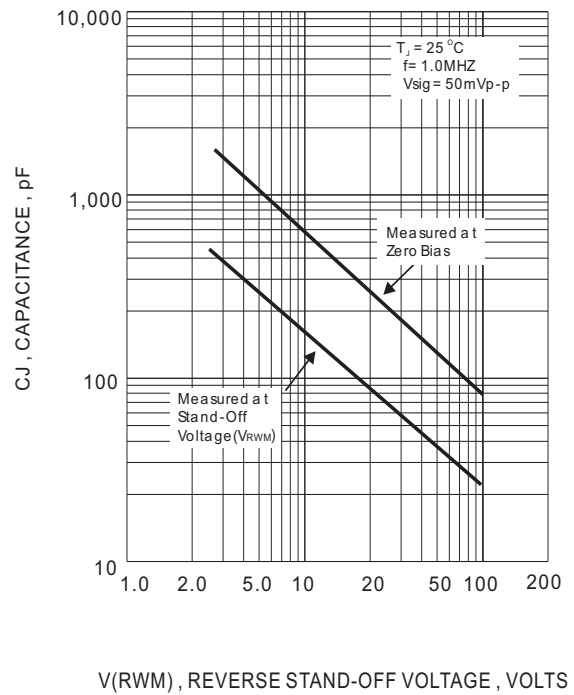

Fig.4 TYPICAL JUNCTION CAPACITANCE

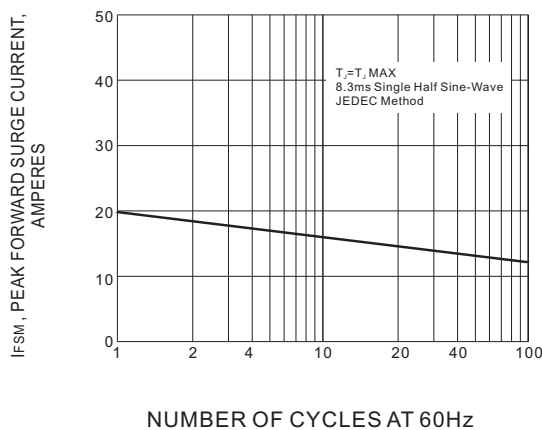

Fig.5 MAXIMUM NON-REPETITIVE PEAK FORWARD SURGE CURRENT



SMF5.0A-AU SERIES

PART NO PACKING CODE VERSION

Part No Packing Code	Package Type	Packing Type	Marking	Version
SMF5.0A-AU_R1_000A1	SOD-123FL	3K pcs / 7" reel	HE	Halogen free
SMF5.0A-AU_R1_000A1	SOD-123FL	10K pcs / 13" reel	HE	Halogen free

MOUNTING PAD LAYOUT

