

# Darlington Amplifier Transistors

NPN Silicon



ON Semiconductor®

[www.onsemi.com](http://www.onsemi.com)

## MMBTA13L, SMMBTA13L, MMBTA14L, SMMBTA14L

### Features

- S Prefix for Automotive and Other Applications Requiring Unique Site and Control Change Requirements; AEC-Q101 Qualified and PPAP Capable
- These Devices are Pb-Free, Halogen Free/BFR Free and are RoHS Compliant\*

### MAXIMUM RATINGS

Rating	Symbol	Value	Unit
Collector - Emitter Voltage	$V_{CES}$	30	Vdc
Collector - Base Voltage	$V_{CBO}$	30	Vdc
Emitter - Base Voltage	$V_{EBO}$	10	Vdc
Collector Current - Continuous	$I_C$	300	mAdc

### THERMAL CHARACTERISTICS

Characteristic	Symbol	Max	Unit
Total Device Dissipation FR-5 Board (Note 1) $T_A = 25^\circ\text{C}$ Derate above $25^\circ\text{C}$	$P_D$	225 1.8	mW mW/ $^\circ\text{C}$
Thermal Resistance, Junction-to-Ambient	$R_{\theta JA}$	556	$^\circ\text{C}/\text{W}$
Total Device Dissipation Alumina Substrate, (Note 2) $T_A = 25^\circ\text{C}$ Derate above $25^\circ\text{C}$	$P_D$	300 2.4	mW mW/ $^\circ\text{C}$
Thermal Resistance, Junction-to-Ambient	$R_{\theta JA}$	417	$^\circ\text{C}/\text{W}$
Junction and Storage Temperature	$T_J, T_{stg}$	-55 to +150	$^\circ\text{C}$

Stresses exceeding those listed in the Maximum Ratings table may damage the device. If any of these limits are exceeded, device functionality should not be assumed, damage may occur and reliability may be affected.

1. FR-5 =  $1.0 \times 0.75 \times 0.062$  in.
2. Alumina =  $0.4 \times 0.3 \times 0.024$  in. 99.5% alumina.

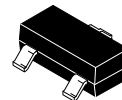

SOT-23 (TO-236)  
CASE 318  
STYLE 6

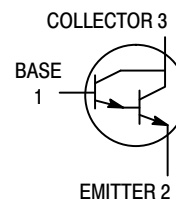

### MARKING DIAGRAM

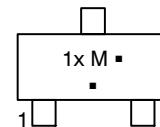

- 1x = Device Code  
 x = M for MMBTA13LT1G,  
 SMMBTA13LT1G  
 x = N for MMBTA14LT1G,  
 SMMBTA14LT1G, T3G  
 M = Date Code\*  
 ■ = Pb-Free Package

(Note: Microdot may be in either location)

\*Date Code orientation and/or overbar may vary depending upon manufacturing location.

### ORDERING INFORMATION

Device	Package	Shipping†
MMBTA13LT1G, SMMBTA13LT1G	SOT-23 (Pb-Free)	3,000 / Tape & Reel
MMBTA14LT1G, SMMBTA14LT1G	SOT-23 (Pb-Free)	3,000 / Tape & Reel
SMMBTA14LT3G	SOT-23 (Pb-Free)	10,000 / Tape & Reel

\*For additional information on our Pb-Free strategy and soldering details, please download the ON Semiconductor Soldering and Mounting Techniques Reference Manual, SOLDERRM/D.

†For information on tape and reel specifications, including part orientation and tape sizes, please refer to our Tape and Reel Packaging Specifications Brochure, BRD8011/D.

# MMBTA13L, SMMBTA13L, MMBTA14L, SMMBTA14L

## ELECTRICAL CHARACTERISTICS ( $T_A = 25^\circ\text{C}$ unless otherwise noted)

Characteristic	Symbol	Min	Max	Unit
<b>OFF CHARACTERISTICS</b>				
Collector – Emitter Breakdown Voltage ( $I_C = 100 \mu\text{Adc}$ , $V_{BE} = 0$ )	$V_{(BR)CES}$	30	–	Vdc
Collector Cutoff Current ( $V_{CB} = 30 \text{ Vdc}$ , $I_E = 0$ )	$I_{CBO}$	–	100	nAdc
Emitter Cutoff Current ( $V_{EB} = 10 \text{ Vdc}$ , $I_C = 0$ )	$I_{EBO}$	–	100	nAdc

## ON CHARACTERISTICS (Note 3)

DC Current Gain ( $I_C = 10 \text{ mAdc}$ , $V_{CE} = 5.0 \text{ Vdc}$ ) MMBTA13, SMMBTA13 MMBTA14, SMMBTA14 ( $I_C = 100 \text{ mAdc}$ , $V_{CE} = 5.0 \text{ Vdc}$ ) MMBTA13, SMMBTA13 MMBTA14, SMMBTA14	$h_{FE}$	5000 10,000 10,000 20,000	– – – –	–
Collector – Emitter Saturation Voltage ( $I_C = 100 \text{ mAdc}$ , $I_B = 0.1 \text{ mAdc}$ )	$V_{CE(sat)}$	–	1.5	Vdc
Base – Emitter On Voltage ( $I_C = 100 \text{ mAdc}$ , $V_{CE} = 5.0 \text{ Vdc}$ )	$V_{BE}$	–	2.0	Vdc

## SMALL-SIGNAL CHARACTERISTICS

Current – Gain – Bandwidth Product (Note 4) ( $I_C = 10 \text{ mAdc}$ , $V_{CE} = 5.0 \text{ Vdc}$ , $f = 100 \text{ MHz}$ )	$f_T$	125	–	MHz
---	-------	-----	---	-----

3. Pulse Test: Pulse Width  $\leq 300 \mu\text{s}$ , Duty Cycle  $\leq 2.0\%$ .

4.  $f_T = |h_{fe}| \cdot f_{test}$ .

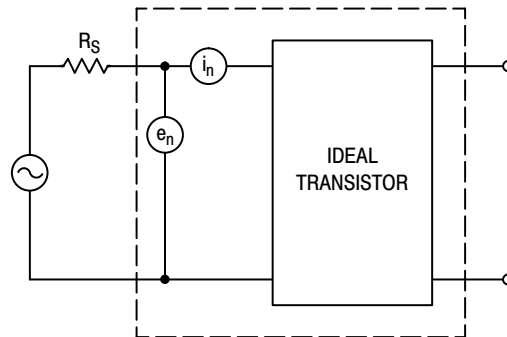

Figure 1. Transistor Noise Model

# MMBTA13L, SMMBTA13L, MMBTA14L, SMMBTA14L

## NOISE CHARACTERISTICS

( $V_{CE} = 5.0 \text{ Vdc}$ ,  $T_A = 25^\circ\text{C}$ )

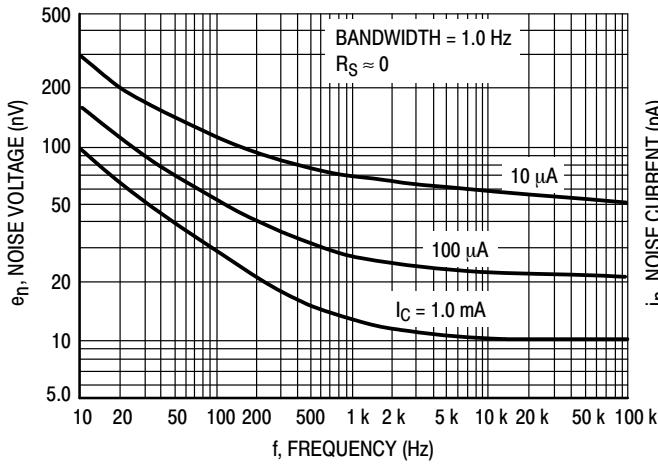

Figure 2. Noise Voltage

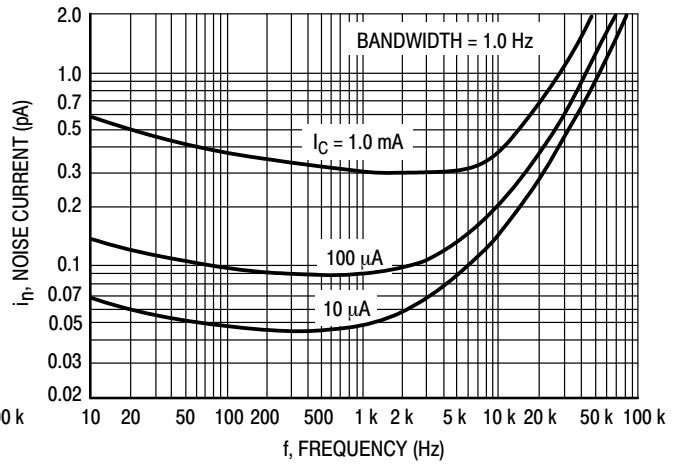

Figure 3. Noise Current

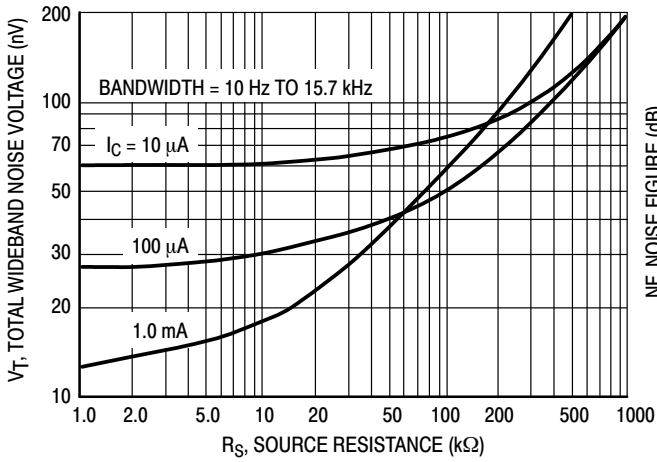

Figure 4. Total Wideband Noise Voltage

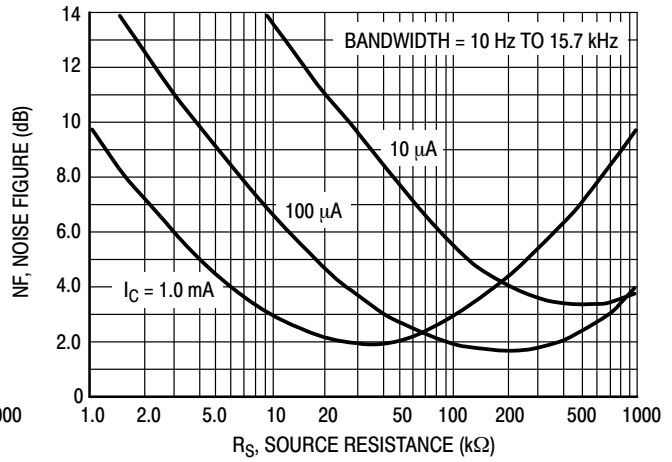

Figure 5. Wideband Noise Figure

# MMBTA13L, SMMBTA13L, MMBTA14L, SMMBTA14L

## SMALL-SIGNAL CHARACTERISTICS

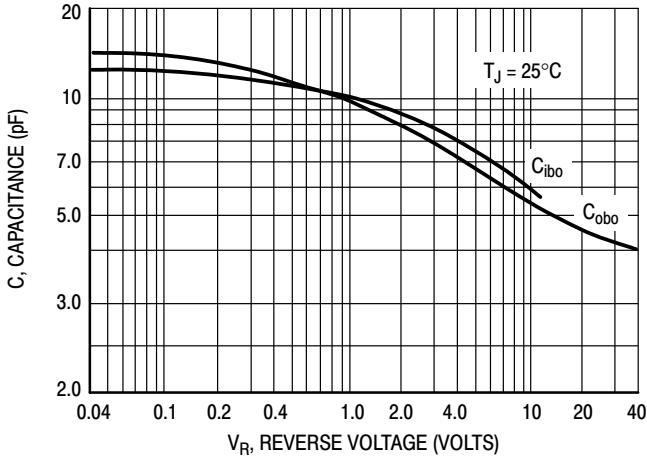

Figure 6. Capacitance

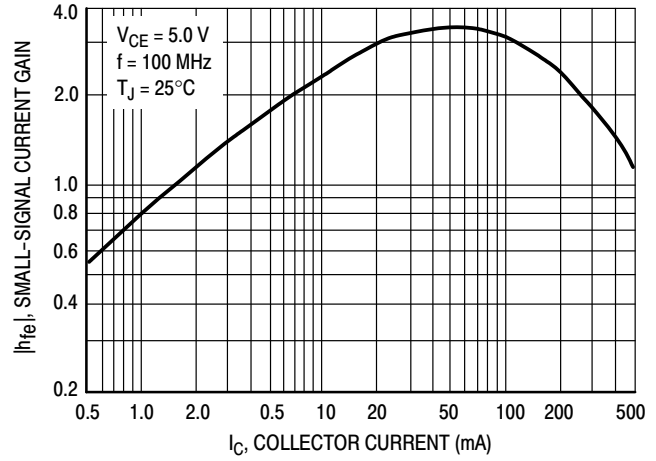

Figure 7. High Frequency Current Gain

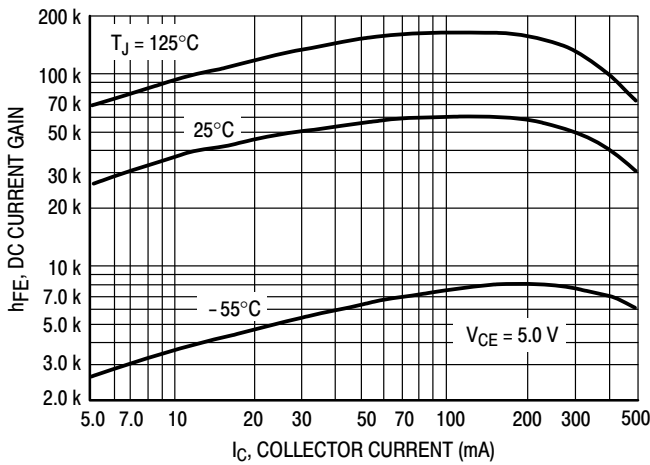

Figure 8. DC Current Gain

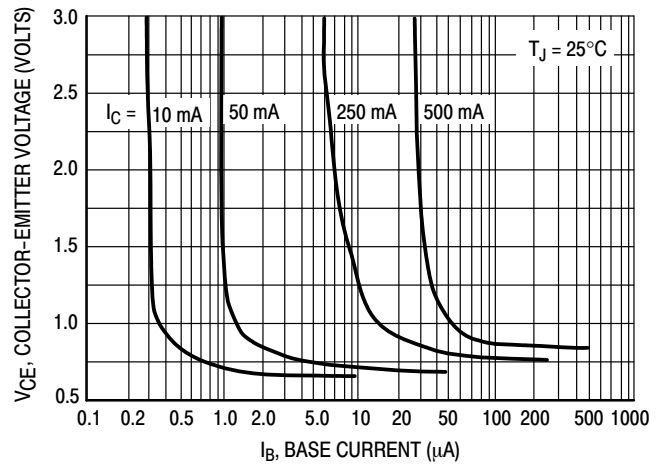

Figure 9. Collector Saturation Region

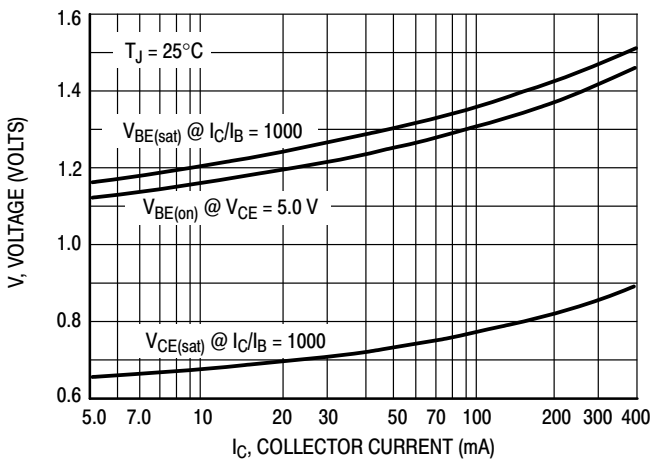

Figure 10. "On" Voltages

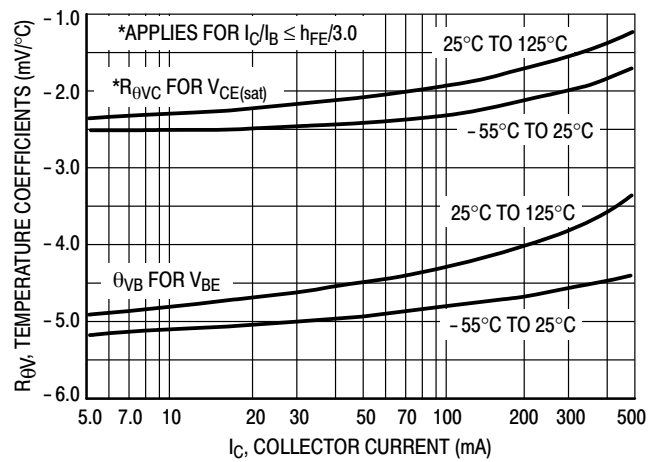

Figure 11. Temperature Coefficients

# MMBTA13L, SMMBTA13L, MMBTA14L, SMMBTA14L

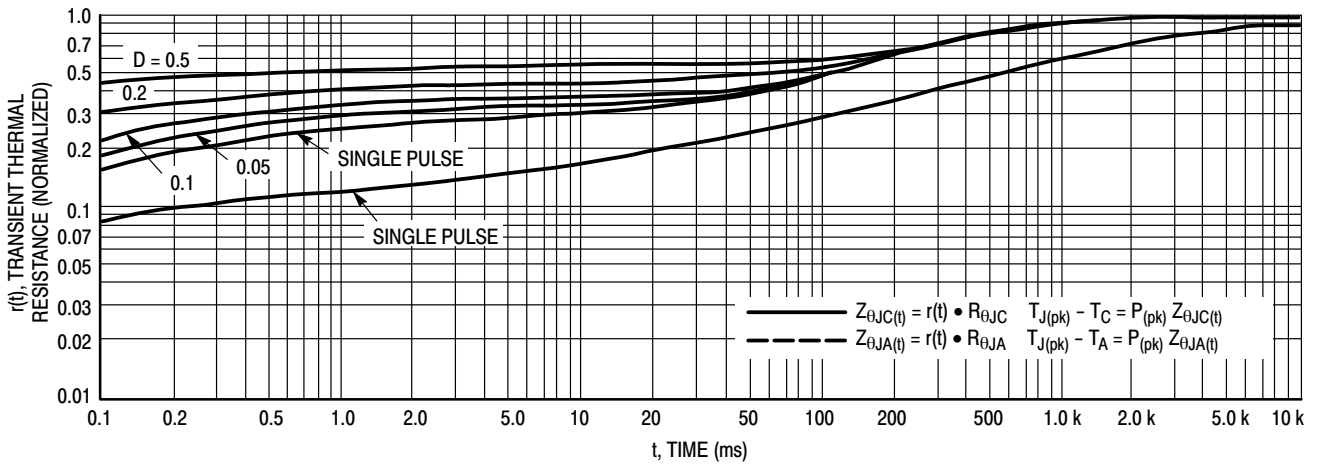

Figure 12. Thermal Response

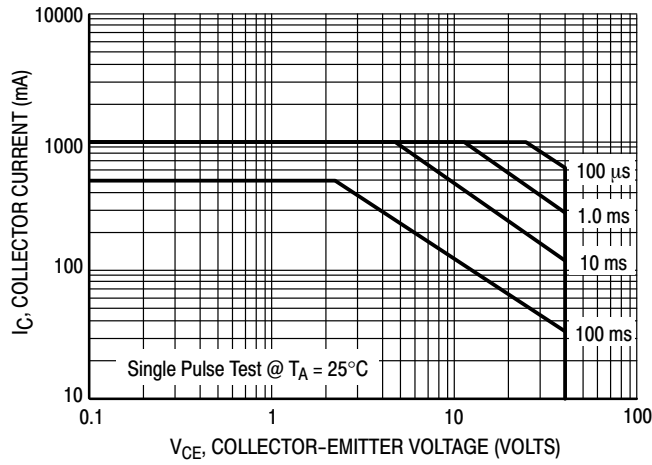
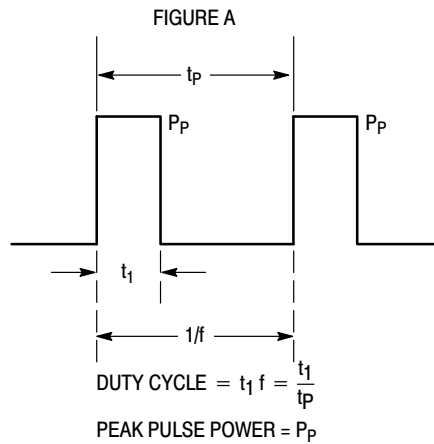

Figure 13. Active Region Safe Operating Area



Design Note: Use of Transient Thermal Resistance Data

# MECHANICAL CASE OUTLINE

## PACKAGE DIMENSIONS

ON Semiconductor®



### SOT-23 (TO-236) CASE 318-08 ISSUE AS

DATE 30 JAN 2018

SCALE 4:1



NOTES:

1. DIMENSIONING AND TOLERANCING PER ASME Y14.5M, 1994.
2. CONTROLLING DIMENSION: MILLIMETERS.
3. MAXIMUM LEAD THICKNESS INCLUDES LEAD FINISH. MINIMUM LEAD THICKNESS IS THE MINIMUM THICKNESS OF THE BASE MATERIAL.
4. DIMENSIONS D AND E DO NOT INCLUDE MOLD FLASH, PROTRUSIONS, OR GATE BURRS.

DIM	MILLIMETERS			INCHES		
	MIN	NOM	MAX	MIN	NOM	MAX
A	0.89	1.00	1.11	0.035	0.039	0.044
A1	0.01	0.06	0.10	0.000	0.002	0.004
b	0.37	0.44	0.50	0.015	0.017	0.020
c	0.08	0.14	0.20	0.003	0.006	0.008
D	2.80	2.90	3.04	0.110	0.114	0.120
E	1.20	1.30	1.40	0.047	0.051	0.055
e	1.78	1.90	2.04	0.070	0.075	0.080
L	0.30	0.43	0.55	0.012	0.017	0.022
L1	0.35	0.54	0.69	0.014	0.021	0.027
HE	2.10	2.40	2.64	0.083	0.094	0.104
T	0°	---	10°	0°	---	10°

### RECOMMENDED SOLDERING FOOTPRINT



### GENERIC MARKING DIAGRAM\*



XXX = Specific Device Code  
M = Date Code  
▪ = Pb-Free Package

\*This information is generic. Please refer to device data sheet for actual part marking. Pb-Free indicator, "G" or microdot "▪", may or may not be present.

STYLE 1 THRU 5:  
CANCELLED

STYLE 6:  
PIN 1. BASE  
2. EMITTER  
3. COLLECTOR

STYLE 7:  
PIN 1. EMITTER  
2. BASE  
3. COLLECTOR

STYLE 8:  
PIN 1. ANODE  
2. NO CONNECTION  
3. CATHODE

STYLE 9:  
PIN 1. ANODE  
2. ANODE  
3. CATHODE

STYLE 10:  
PIN 1. DRAIN  
2. SOURCE  
3. GATE

STYLE 11:  
PIN 1. ANODE  
2. CATHODE  
3. CATHODE-ANODE

STYLE 12:  
PIN 1. CATHODE  
2. CATHODE  
3. ANODE

STYLE 13:  
PIN 1. SOURCE  
2. DRAIN  
3. GATE

STYLE 14:  
PIN 1. CATHODE  
2. GATE  
3. ANODE

STYLE 15:  
PIN 1. GATE  
2. CATHODE  
3. ANODE

STYLE 16:  
PIN 1. ANODE  
2. CATHODE  
3. CATHODE

STYLE 17:  
PIN 1. NO CONNECTION  
2. ANODE  
3. CATHODE

STYLE 18:  
PIN 1. NO CONNECTION  
2. CATHODE  
3. ANODE

STYLE 19:  
PIN 1. CATHODE  
2. ANODE  
3. CATHODE-ANODE

STYLE 20:  
PIN 1. CATHODE  
2. ANODE  
3. GATE

STYLE 21:  
PIN 1. GATE  
2. SOURCE  
3. DRAIN

STYLE 22:  
PIN 1. RETURN  
2. OUTPUT  
3. INPUT

STYLE 23:  
PIN 1. ANODE  
2. ANODE  
3. CATHODE

STYLE 24:  
PIN 1. GATE  
2. DRAIN  
3. SOURCE

STYLE 25:  
PIN 1. ANODE  
2. CATHODE  
3. GATE

STYLE 26:  
PIN 1. CATHODE  
2. ANODE  
3. NO CONNECTION

STYLE 27:  
PIN 1. CATHODE  
2. CATHODE  
3. CATHODE

STYLE 28:  
PIN 1. ANODE  
2. ANODE  
3. ANODE

<b>DOCUMENT NUMBER:</b>	<b>98ASB42226B</b>	Electronic versions are uncontrolled except when accessed directly from the Document Repository. Printed versions are uncontrolled except when stamped "CONTROLLED COPY" in red.
<b>DESCRIPTION:</b>	<b>SOT-23 (TO-236)</b>	<b>PAGE 1 OF 1</b>

ON Semiconductor and are trademarks of Semiconductor Components Industries, LLC dba ON Semiconductor or its subsidiaries in the United States and/or other countries. ON Semiconductor reserves the right to make changes without further notice to any products herein. ON Semiconductor makes no warranty, representation or guarantee regarding the suitability of its products for any particular purpose, nor does ON Semiconductor assume any liability arising out of the application or use of any product or circuit, and specifically disclaims any and all liability, including without limitation special, consequential or incidental damages. ON Semiconductor does not convey any license under its patent rights nor the rights of others.