

## 2N3458, 2N3459, 2N3460 N-Channel JFET

### Features

- InterFET [N0016H Geometry](#)
- InterFET [N0032H Geometry](#) (2N3458)
- Low Noise: 5 nV/√Hz Typical
- High Gain: 7.5mS Typical (2N3458)
- Low Cutoff Voltage: 2N3460 < 1.8V
- RoHS Compliant
- SMT, TH, and Bare Die Package options.

### Applications

- General Purpose Amplifiers

### Description

The -50V InterFET 2N3458, 2N3459, and 2N3460 are targeted for sensitive amplifier stages for mid-frequencies designs. Gate leakages are typically less than 10pA at room temperatures. The 2N3460 has a cutoff voltage of less than 1.8V ideal for low-level power supplies. The TO-18 package is hermetically sealed and suitable for military applications.

TO-18 Bottom View

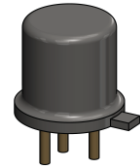
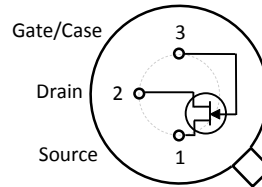

SOT23 Top View

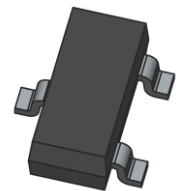
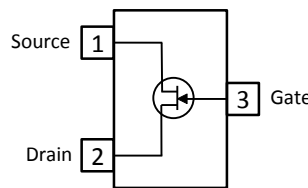

TO-92 Bottom View

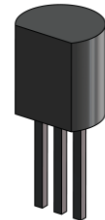
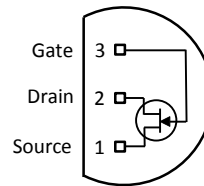

### Product Summary

Parameters	2N3458 Min	2N3459 Min	2N3460 Min	Unit
$BV_{GSS}$ Gate to Source Breakdown Voltage	-50	-50	-50	V
$I_{DSS}$ Drain to Source Saturation Current	3	0.8	0.2	mA
$V_{GS(off)}$ Gate to Source Cutoff Voltage	-7.8 (Max)	-3.4 (Max)	-1.8 (Max)	V
$G_{FS}$ Forward Transconductance	2.5	1.5	0.8	mS

### Ordering Information Custom Part and Binning Options Available

Part Number	Description	Case	Packaging
2N3458; 2N3459; 2N3460	Through-Hole	TO-18	Bulk
PN3458; PN3459; PN3460	Through-Hole	TO-92	Bulk
SMP3458; SMP3459; SMP3460	Surface Mount	SOT23	Bulk
SMP3458TR; SMP3459TR; SMP3460TR	7" Tape and Reel: Max 3,000 Pieces 13" Tape and Reel: Max 9,000 Pieces	SOT23	Minimum 1,000 Pieces Tape and Reel
2N3458COT; 2N3459COT; 2N3460COT	Chip Orientated Tray (COT Waffle Pack)	COT	400/Waffle Pack
2N3458CFT; 2N3459CFT; 2N3460CFT	Chip Face-up Tray (CFT Waffle Pack)	CFT	400/Waffle Pack



**Disclaimer:** It is the Buyers responsibility for designing, validating and testing the end application under all field use cases and extreme use conditions. Guaranteeing the application meets required standards, regulatory compliance, and all safety and security requirements is the responsibility of the Buyer. These resources are subject to change without notice.

## Electrical Characteristics

### Maximum Ratings (@ T<sub>A</sub> = 25°C, Unless otherwise specified)

Parameters	Value	Unit
V <sub>RGS</sub> Reverse Gate Source and Gate Drain Voltage	-50	V
I <sub>FG</sub> Continuous Forward Gate Current	10	mA
P <sub>D</sub> Continuous Device Power Dissipation	300	mW
P Power Derating	1.7	mW/°C
T <sub>J</sub> Operating Junction Temperature	-55 to 125	°C
T <sub>STG</sub> Storage Temperature	-65 to 150	°C

### Static Characteristics (@ T<sub>A</sub> = 25°C, Unless otherwise specified)

Parameters	Conditions	2N3458		2N3459		2N3460		Unit
		Min	Max	Min	Max	Min	Max	
V <sub>(BR)GSS</sub> Gate to Source Breakdown Voltage	V <sub>DS</sub> = 0V, I <sub>G</sub> = -1μA	-50		-50		-50		V
I <sub>GSS</sub> Gate to Source Reverse Current	V <sub>GS</sub> = -30V, V <sub>DS</sub> = 0V		-1		-1		-1	nA
V <sub>GS(OFF)</sub> Gate to Source Cutoff Voltage	V <sub>DS</sub> = 20V, I <sub>D</sub> = 1nA		-7.8		-3.4		-1.8	V
I <sub>DSS</sub> Drain to Source Saturation Current	V <sub>DS</sub> = 20V, V <sub>GS</sub> = 0V (Pulsed)	3	15	0.8	4	0.2	1	mA

### Dynamic Characteristics (@ T<sub>A</sub> = 25°C, Unless otherwise specified)

Parameters	Conditions	2N3458		2N3459		2N3460		Unit
		Min	Max	Min	Max	Min	Max	
G <sub>FS</sub> Forward Transconductance	V <sub>DS</sub> = -20V, V <sub>GS</sub> = 0V, f = 1kHz	2.5	10	1.5	6	0.8	4.5	mS
C <sub>iss</sub> Input Capacitance	V <sub>DS</sub> = 0V, V <sub>GS</sub> = ( ), f = 1MHz		18 (10)		18 (8)		18 (4)	pF V
C <sub>rss</sub> Reverse Transfer Capacitance	V <sub>DS</sub> = 30V, I <sub>D</sub> = 5mA, f = 1MHz		5		5		5	pF

## SOT23 (TO-236AB) Mechanical and Layout Data

### Package Outline Data



1. All linear dimensions are in millimeters.
2. Package weight approximately 0.12 grams
3. Molded plastic case UL 94V-0 rated
4. For Tape and Reel specifications refer to InterFET CTC-021 Tape and Reel Specification, Document number: IF39002
5. Bulk product is shipped in standard ESD shipping material
6. Refer to JEDEC standards for additional information.

### Suggested Pad Layout

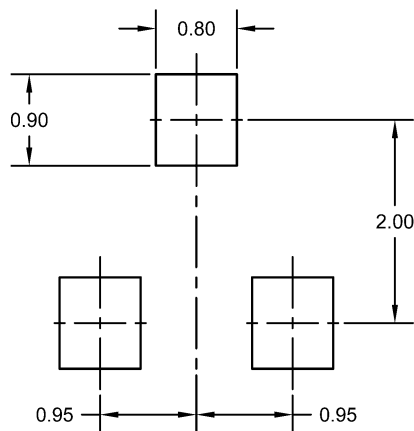

1. All linear dimensions are in millimeters.
2. The suggested land pattern dimensions have been provided for reference only. A more robust pattern may be desired for wave soldering.

## TO-18 Mechanical and Layout Data

### Package Outline Data

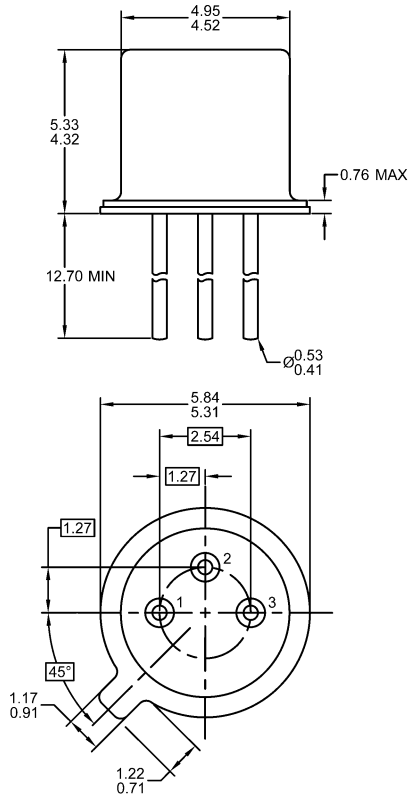

1. All linear dimensions are in millimeters.
2. Package weight approximately 0.29 grams
3. Bulk product is shipped in standard ESD shipping material
4. Refer to JEDEC standards for additional information.

### Suggested Through-Hole Layout

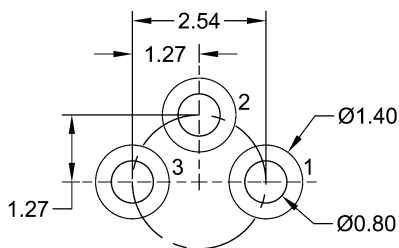

1. All linear dimensions are in millimeters.
2. The suggested land pattern dimensions have been provided as a straight lead reference only. A more robust pattern may be desired for wave soldering and/or bent lead configurations.