

## IFN3993/A, IFN3994/A P-Channel JFET

### Features

- InterFET [P0099F Geometry](#)
- Typical Noise: 8 nV/VHz
- Fast Switching
- Replacement for 2N3993,4 Parts
- RoHS Compliant
- SMT, TH, and Bare Die Package options.

### Applications

- Choppers
- High Speed Commutators

### Description

The 25V InterFET IFN3993/A and IFN3994/A are targeted for choppers and high speed commutator designs. The on resistance is typically less than 100 Ohms at room temperatures. The TO-72 package is hermetically sealed and suitable for military applications.

TO-72 Bottom View

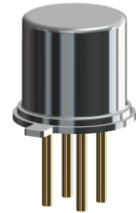
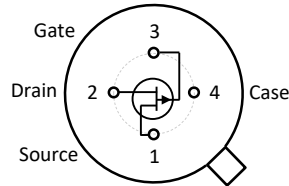

SOT23 Top View

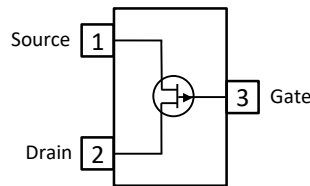

TO-92 Bottom View

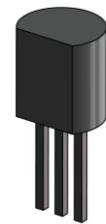
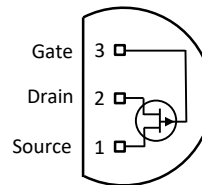

### Product Summary (Highlighted values = A variant)

Parameters	IFN3993/A Min	IFN3994/A Min	Unit
BV <sub>GSS</sub> Gate to Source Breakdown Voltage	25	25	V
I <sub>DSS</sub> Drain to Source Saturation Current	-10	-2	mA
V <sub>GS(off)</sub> Gate to Source Cutoff Voltage	4	1	V
G <sub>FS</sub> Forward Transconductance	6	4	μS
	7	5	

### Ordering Information Custom Part and Binning Options Available

Part Number	Description	Case	Packaging
IFN3993; IFN3994 IFN3993A; IFN3994A	Through-Hole	TO-72	Bulk
PN3993; PN3994 PN3993A; PN3994A	Through-Hole	TO-92	Bulk
SMP3993; SMP3994 SMP3993A; SMP3994A	Surface Mount	SOT23	Bulk
SMP3993TR; SMP3994TR SMP3993ATR; SMP3994ATR	7" Tape and Reel: Max 3,000 Pieces 13" Tape and Reel: Max 9,000 Pieces	SOT23	Minimum 1,000 Pieces Tape and Reel
IFN3993COT; IFN3994COT IFN3993ACOT; IFN3994ACOT	Chip Orientated Tray (COT Waffle Pack)	COT	400/Waffle Pack
IFN3993CFT; IFN3994CFT IFN3993ACFT; IFN3994ACFT	Chip Face-up Tray (CFT Waffle Pack)	CFT	400/Waffle Pack



**Disclaimer:** It is the Buyers responsibility for designing, validating and testing the end application under all field use cases and extreme use conditions. Guaranteeing the application meets required standards, regulatory compliance, and all safety and security requirements is the responsibility of the Buyer. These resources are subject to change without notice.

## Electrical Characteristics

### Maximum Ratings (@ $T_A = 25^\circ\text{C}$ , Unless otherwise specified)

Parameters	Value	Unit
$V_{RGS}$ Reverse Gate Source and Gate Drain Voltage	25	V
$I_{FG}$ Continuous Forward Gate Current	-10	mA
$P_D$ Continuous Device Power Dissipation	300	mW
$P$ Power Derating	2.4	mW/ $^\circ\text{C}$
$T_J$ Operating Junction Temperature	-55 to 125	$^\circ\text{C}$
$T_{STG}$ Storage Temperature	-65 to 150	$^\circ\text{C}$

### Static Characteristics (@ $T_A = 25^\circ\text{C}$ , Unless otherwise specified, Highlighted values = A variant)

Parameters	Conditions	IFN3993/A		IFN3994/A		Unit
		Min	Max	Min	Max	
$V_{(BR)GSS}$ Gate to Source Breakdown Voltage	$V_{DS} = 0V, I_G = 1\mu\text{A}$	25		25		V
$V_{GS(OFF)}$ Gate to Source Cutoff Voltage	$V_{DS} = -10V, I_D = -1\mu\text{A}$	4	9.5	1	5.5	V
$I_{DSS}$ Drain to Source Saturation Current	$V_{GS} = 0V, V_{DS} = -10V$ (Pulsed)	-10		-2		mA
$I_{DGO}$ Drain Reverse Current	$V_{GS} = -15V, I_S = 0A, T_A = 25^\circ\text{C}$ $V_{GS} = -15V, I_S = 0A, T_A = 150^\circ\text{C}$		-1.2		-1.2	nA $\mu\text{A}$
$I_{D(OFF)}$ Drain Cutoff Current	$V_{DS} = -10V, V_{GS} = 10V, T_A = 25^\circ\text{C}$ $V_{DS} = -10V, V_{GS} = 10V, T_A = 150^\circ\text{C}$		-1.2 -1		-1.2 -1	nA $\mu\text{A}$

### Dynamic Characteristics (@ $T_A = 25^\circ\text{C}$ , Unless otherwise specified, Highlighted values = A variant)

Parameters	Conditions	IFN3993/A		IFN3994/A		Unit
		Min	Max	Min	Max	
$G_{FS}$ Forward Transconductance	$V_{DS} = -10V, V_{GS} = 0V, f = 1\text{kHz}$	6 7	12	4 5	10	mS
$R_{DS(ON)}$ Drain to Source ON Resistance	$V_{GS} = 0V, I_D = 0A, f = 1\text{kHz}$		150		300	$\Omega$
$C_{iss}$ Input Capacitance	$V_{DS} = -10V, V_{GS} = 0V, f = 1\text{MHz}$		16 12		16 12	pF
$C_{rss}$ Reverse Transfer Capacitance	$V_{DS} = 0V, V_{GS} = 10V, f = 1\text{MHz}$		4.5 3		5 3.5	pF

## SOT23 (TO-236AB) Mechanical and Layout Data

### Package Outline Data



1. All linear dimensions are in millimeters.
2. Package weight approximately 0.12 grams
3. Molded plastic case UL 94V-0 rated
4. For Tape and Reel specifications refer to InterFET CTC-021 Tape and Reel Specification, Document number: IF39002
5. Bulk product is shipped in standard ESD shipping material
6. Refer to JEDEC standards for additional information.

### Suggested Pad Layout



1. All linear dimensions are in millimeters.
2. The suggested land pattern dimensions have been provided for reference only. A more robust pattern may be desired for wave soldering.

## TO-72 Mechanical and Layout Data

### Package Outline Data

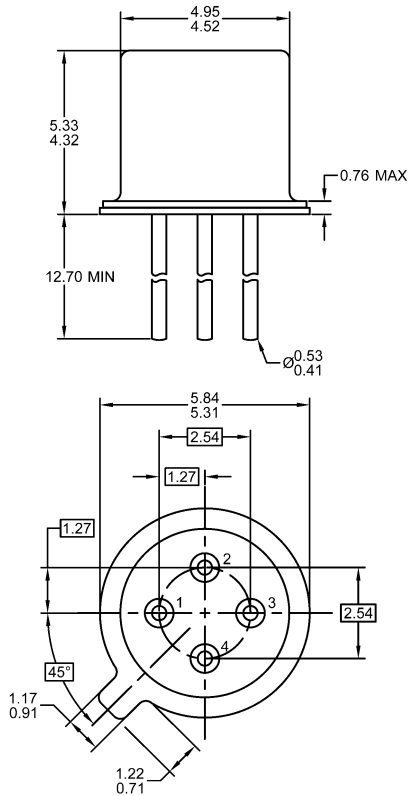

1. All linear dimensions are in millimeters.
2. Four leaded device. Not all leads are shown in drawing views.
3. Package weight approximately 0.31 grams
4. Bulk product is shipped in standard ESD shipping material
5. Refer to JEDEC standards for additional information.

### Suggested Through-Hole Layout

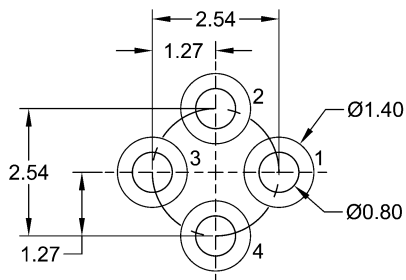

1. All linear dimensions are in millimeters.
2. The suggested land pattern dimensions have been provided as a straight lead reference only. A more robust pattern may be desired for wave soldering and/or bent lead configurations.