

## 2N4222, 2N4222A N-Channel JFET

### Features

- InterFET [N0032H Geometry](#)
- Typical Noise: 7 nV/√Hz
- Low Ciss: 6.0pF Typical
- RoHS Compliant
- SMT, TH, and Bare Die Package options.

### Applications

- Mixers
- Oscillators
- VHF Amplifiers
- Small Signal Amplifiers

### Description

The -50V InterFET 2N4222 and 2N4222A are targeted for sensitive amplifier stages for mid-frequencies designs. The “A” variants are screened for lower noise. The TO-72 package is hermetically sealed and suitable for military applications.

TO-72 Bottom View

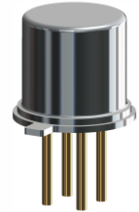
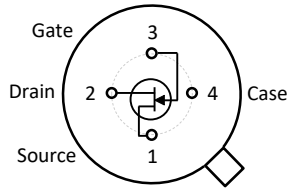

SOT23 Top View

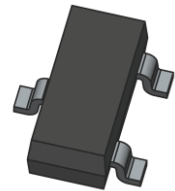
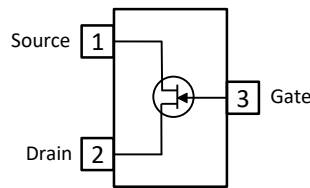

TO-92 Bottom View

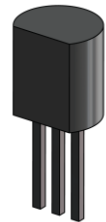
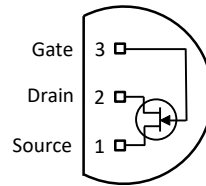

### Product Summary

| Parameters                                   | 2N4222 Min | 2N4222A Min | Unit    |
|--|------------|-------------|---------|
| $BV_{GSS}$ Gate to Source Breakdown Voltage  | -30        | -30         | V       |
| $I_{DSS}$ Drain to Source Saturation Current | 5          | 5           | mA      |
| $V_{GS(off)}$ Gate to Source Cutoff Voltage  |            |             | V       |
| $G_{FS}$ Forward Transconductance            | 2500       | 2500        | $\mu S$ |

### Ordering Information Custom Part and Binning Options Available

| Part Number           | Description   | Case  | Packaging                             |
|-----------------------|---|-------|---------------------------------------|
| 2N4222; 2N4222A       | Through-Hole  | TO-72 | Bulk                                  |
| PN4222; PN4222A       | Through-Hole  | TO-92 | Bulk                                  |
| SMP4222; SMP4222A     | Surface Mount   | SOT23 | Bulk                                  |
| SMP4222TR; SMP4222ATR | 7" Tape and Reel: Max 3,000 Pieces<br>13" Tape and Reel: Max 9,000 Pieces | SOT23 | Minimum 1,000 Pieces<br>Tape and Reel |
| 2N4222COT; 2N4222ACOT | Chip Orientated Tray (COT Waffle Pack)                                    | COT   | 400/Waffle Pack                       |
| 2N4222CFT; 2N4222ACFT | Chip Face-up Tray (CFT Waffle Pack)                                       | CFT   | 400/Waffle Pack                       |



**Disclaimer:** It is the Buyers responsibility for designing, validating and testing the end application under all field use cases and extreme use conditions. Guaranteeing the application meets required standards, regulatory compliance, and all safety and security requirements is the responsibility of the Buyer. These resources are subject to change without notice.

## Electrical Characteristics

### Maximum Ratings (@ $T_A = 25^\circ\text{C}$ , Unless otherwise specified)

| Parameters   | Value      | Unit                 |
|--|------------|----------------------|
| $V_{RGS}$ Reverse Gate Source and Gate Drain Voltage | -30        | V                    |
| $I_{FG}$ Continuous Forward Gate Current             | 10         | mA                   |
| $P_D$ Continuous Device Power Dissipation            | 300        | mW                   |
| P Power Derating                                     | 2          | mW/ $^\circ\text{C}$ |
| $T_J$ Operating Junction Temperature                 | -55 to 125 | $^\circ\text{C}$     |
| $T_{STG}$ Storage Temperature                        | -65 to 150 | $^\circ\text{C}$     |

### Static Characteristics (@ $T_A = 25^\circ\text{C}$ , Unless otherwise specified)

| Parameters                                     | Conditions  | 2N4222      |              | 2N4222A     |              | Unit                |
|--|---|-------------|--------------|-------------|--------------|---------------------|
|  |   | Min         | Max          | Min         | Max          |                     |
| $V_{(BR)GSS}$ Gate to Source Breakdown Voltage | $V_{DS} = 0V, I_G = -1\mu\text{A}$  | -30         |              | -30         |              | V                   |
| $I_{GSS}$ Gate to Source Reverse Current       | $V_{GS} = -15V, V_{DS} = 0V, T_A = 25^\circ\text{C}$<br>$V_{GS} = -15V, V_{DS} = 0V, T_A = 150^\circ\text{C}$ |             | -0.1<br>-0.1 |             | -0.1<br>-0.1 | nA<br>$\mu\text{A}$ |
| $V_{GS}$ Gate Source Voltage                   | $V_{DS} = 15V, I_D = ( )$   | -2<br>(500) | -6<br>(500)  | -2<br>(500) | -6<br>(500)  | V<br>$\mu\text{A}$  |
| $V_{GS(OFF)}$ Gate to Source Cutoff Voltage    | $V_{DS} = 15V, I_D = 0.1\text{nA}$  |             | -8           |             | -8           | V                   |
| $I_{DSS}$ Drain to Source Saturation Current   | $V_{GS} = 0V, V_{DS} = 15V$<br>(Pulsed)   | 5           | 15           | 5           | 15           | mA                  |

### Dynamic Characteristics (@ $T_A = 25^\circ\text{C}$ , Unless otherwise specified)

| Parameters                             | Conditions  | 2N4222 |      | 2N4222A |      | Unit          |
|--|---|--------|------|---------|------|---------------|
|  |   | Min    | Max  | Min     | Max  |               |
| $G_{FS}$ Forward Transconductance      | $V_{DS} = 15V, V_{GS} = 0V, f = 1\text{kHz}$                            | 2500   | 6000 | 2500    | 6000 | $\mu\text{S}$ |
| $G_{OS}$ Output Conductance            | $V_{DS} = 15V, V_{GS} = 0V, f = 1\text{kHz}$                            |        | 40   |         | 40   | $\mu\text{S}$ |
| $C_{ISS}$ Input Capacitance            | $V_{DS} = 15V, V_{GS} = 0V, f = 1\text{MHz}$                            |        | 6    |         | 6    | pF            |
| $C_{RSS}$ Reverse Transfer Capacitance | $V_{DS} = 15V, V_{GS} = 0V, f = 1\text{MHz}$                            |        | 2    |         | 2    | pF            |
| NF Noise Figure                        | $V_{DS} = 15V, V_{GS} = 0V, f = 1\text{kHz}$<br>$R_G = 1\text{M}\Omega$ |        |      |         | 2.5  | dB            |

## SOT23 (TO-236AB) Mechanical and Layout Data

### Package Outline Data



1. All linear dimensions are in millimeters.
2. Package weight approximately 0.12 grams
3. Molded plastic case UL 94V-0 rated
4. For Tape and Reel specifications refer to InterFET CTC-021 Tape and Reel Specification, Document number: IF39002
5. Bulk product is shipped in standard ESD shipping material
6. Refer to JEDEC standards for additional information.

### Suggested Pad Layout



1. All linear dimensions are in millimeters.
2. The suggested land pattern dimensions have been provided for reference only. A more robust pattern may be desired for wave soldering.

## TO-72 Mechanical and Layout Data

### Package Outline Data

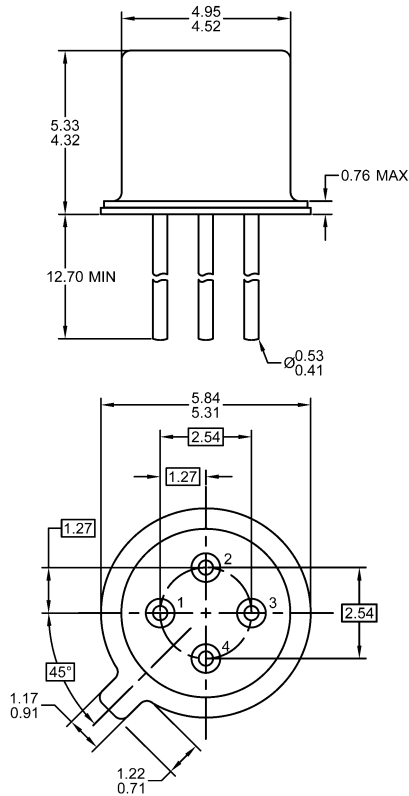

1. All linear dimensions are in millimeters.
2. Four leaded device. Not all leads are shown in drawing views.
3. Package weight approximately 0.31 grams
4. Bulk product is shipped in standard ESD shipping material
5. Refer to JEDEC standards for additional information.

### Suggested Through-Hole Layout

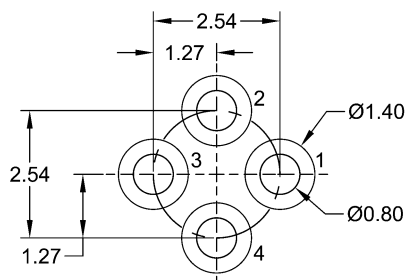

1. All linear dimensions are in millimeters.
2. The suggested land pattern dimensions have been provided as a straight lead reference only. A more robust pattern may be desired for wave soldering and/or bent lead configurations.