

2N4338, 2N4339 N-Channel JFET

Features

- InterFET [N0016SH Geometry](#)
- Low Noise: 4.2 nV/√Hz Typical
- High Gain: 1.6mS Typical (2N4339)
- Low Cutoff Voltage: 2N4338 < 1.0V
- RoHS Compliant
- SMT, TH, and Bare Die Package options.

Applications

- Audio Amplifiers
- Small Signal Amplifier
- Ultrahigh Impedance Pre-Amplifier
- Voltage Controlled Resistor
- Current Limiters and Regulators

Description

The -50V InterFET 2N4338 and 2N4339 are targeted for sensitive amplifier stages for mid-frequencies designs. Gate leakages are typically less than 10pA at room temperatures. The 2N4338 has a cutoff voltage of less than 1.0V ideal for low-level power supplies. The TO-18 package is hermetically sealed and suitable for military applications.

TO-18 Bottom View

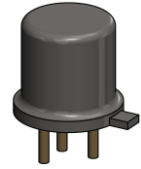
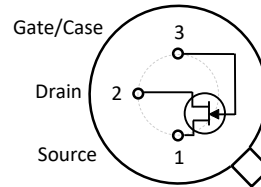

SOT23 Top View



TO-92 Bottom View

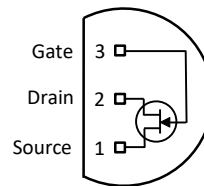

Product Summary

Parameters		2N4338 Min	2N4339 Min	Unit
BV _{GSS}	Gate to Source Breakdown Voltage	-50	-50	V
I _{DSS}	Drain to Source Saturation Current	0.2	0.5	mA
V _{GS(off)}	Gate to Source Cutoff Voltage	-0.3	-0.6	V
G _{FS}	Forward Transconductance	600	800	μS

Ordering Information

Part Number	Description	Case	Packaging
2N4338; 2N4339	Through-Hole	TO-18	Bulk
PN4338; PN4339	Through-Hole	TO-92	Bulk
SMP4338; SMP4339	Surface Mount	SOT23	Bulk
SMP4338TR; SMP4339TR	7" Tape and Reel: Max 3,000 Pieces 13" Tape and Reel: Max 9,000 Pieces	SOT23	Minimum 1,000 Pieces Tape and Reel
2N4338COT; 2N4339COT	Chip Orientated Tray (COT Waffle Pack)	COT	400/Waffle Pack
2N4338CFT; 2N4339CFT	Chip Face-up Tray (CFT Waffle Pack)	CFT	400/Waffle Pack



Disclaimer: It is the Buyers responsibility for designing, validating and testing the end application under all field use cases and extreme use conditions. Guaranteeing the application meets required standards, regulatory compliance, and all safety and security requirements is the responsibility of the Buyer. These resources are subject to change without notice.

Electrical Characteristics

Maximum Ratings (@ $T_A = 25^\circ\text{C}$, Unless otherwise specified)

Parameters	Value	Unit
V_{RGS} Reverse Gate Source and Gate Drain Voltage	-50	V
I_{FG} Continuous Forward Gate Current	50	mA
P_D Continuous Device Power Dissipation	300	mW
P Power Derating	2	mW/ $^\circ\text{C}$
T_J Operating Junction Temperature	-55 to 125	$^\circ\text{C}$
T_{STG} Storage Temperature	-65 to 175	$^\circ\text{C}$

Static Characteristics (@ $T_A = 25^\circ\text{C}$, Unless otherwise specified)

Parameters	Conditions	2N4338		2N4339		Unit
		Min	Max	Min	Max	
$V_{(BR)GSS}$ Gate to Source Breakdown Voltage	$V_{DS} = 0V, I_G = -1\mu\text{A}$	-50		-50		V
I_{GSS} Gate to Source Reverse Current	$V_{GS} = -30V, V_{DS} = 0V, T_A = 25^\circ\text{C}$ $V_{GS} = -30V, V_{DS} = 0V, T_A = 150^\circ\text{C}$		-0.1 -100		-0.1 -100	nA
$V_{GS(OFF)}$ Gate to Source Cutoff Voltage	$V_{DS} = 15V, I_D = 0.1\mu\text{A}$	-0.3	-1.0	-0.6	-1.8	V
I_{DSS} Drain to Source Saturation Current	$V_{GS} = 0V, V_{DS} = 15V$ (Pulsed)	0.2	0.6	0.5	1.5	mA
$I_{D(OFF)}$ Drain Cutoff Current	$V_{DS} = 15V, V_{GS} = -5V$		0.05		0.05	nA
I_{DF} Forward Diode Voltage	$V_{DS} = 0V, I_{GS} = 10\mu\text{A}$	0.4	0.8	0.4	0.8	V

Dynamic Characteristics (@ $T_A = 25^\circ\text{C}$, Unless otherwise specified)

Parameters	Conditions	2N4338		2N4339		Unit
		Min	Max	Min	Max	
G_{FS} Forward Transconductance	$V_{DS} = 15V, V_{GS} = 0V, f = 1\text{kHz}$	600	1800	800	2400	μS
G_{OS} Output Conductance	$V_{DS} = 15V, V_{GS} = 0V, f = 1\text{kHz}$		5		15	μS
$R_{DS(ON)}$ Drain to Source ON Resistance	$V_{GS} = 0V, I_D = 0A, f = 1\text{kHz}$		2500		1700	Ω
C_{iss} Input Capacitance	$V_{DS} = 15V, V_{GS} = 0V, f = 1\text{MHz}$		7		7	pF
C_{rss} Reverse Transfer Capacitance	$V_{DS} = 15V, V_{GS} = 0V, f = 1\text{MHz}$		3		3	pF
NF Noise Figure	$V_{DS} = 15V, V_{GS} = 0V, f = 1\text{kHz}$ $R_G = 1\text{M}\Omega, \text{BW} = 200\text{Hz}$		1		1	dB

Typical 2N4338, 2N4339 Characteristics

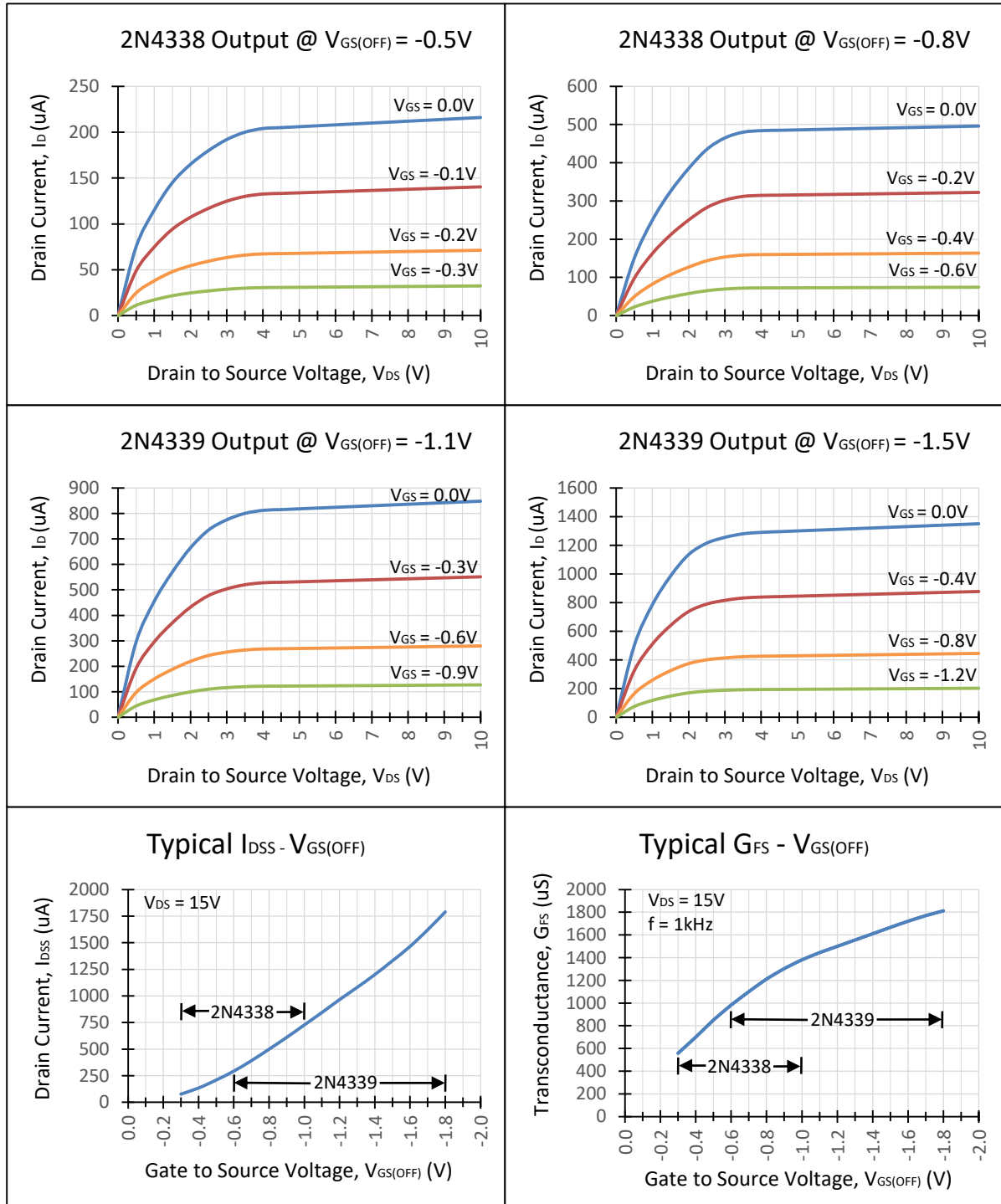

Typical 2N4338, 2N4339 Characteristics (Continued)

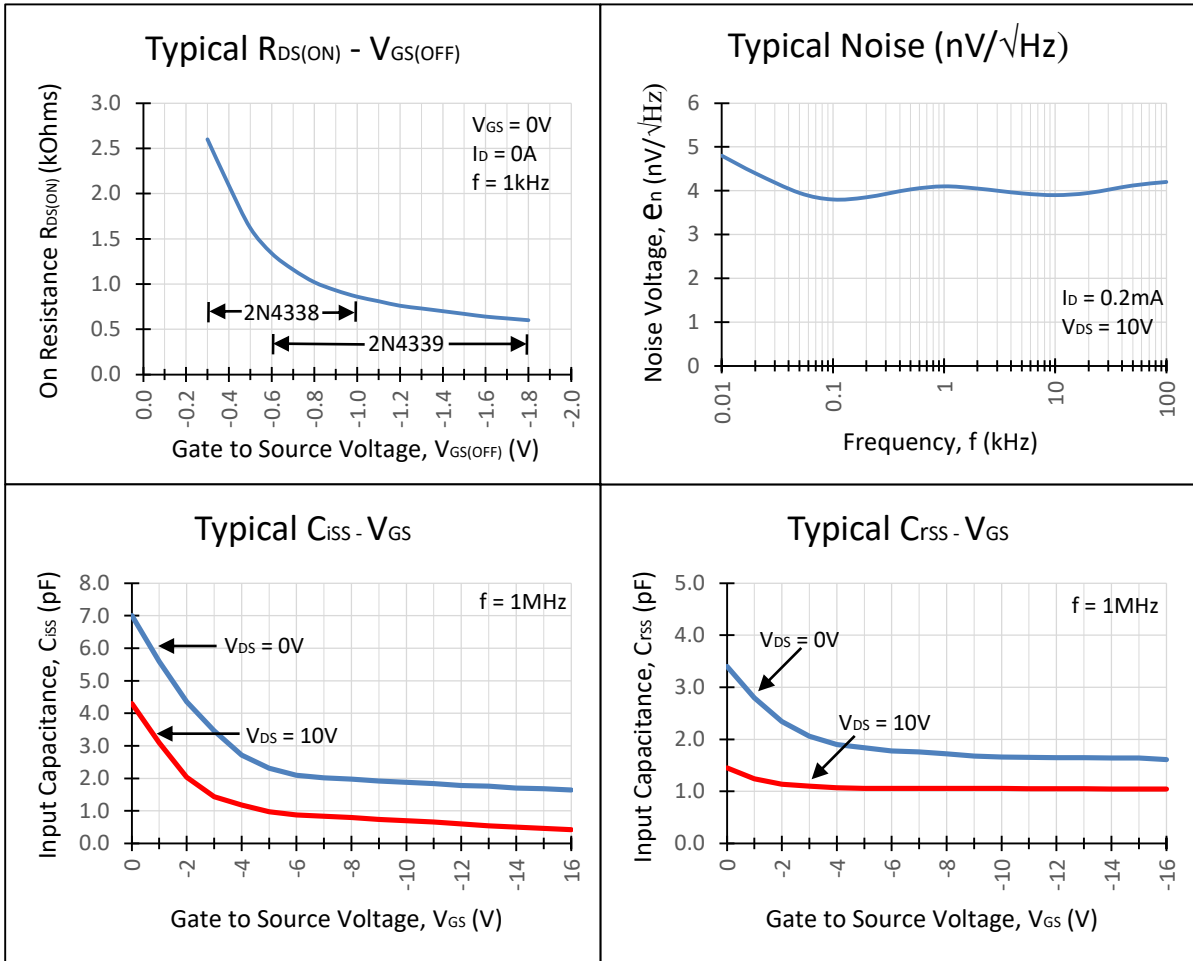

SOT23 (TO-236AB) Mechanical and Layout Data

Package Outline Data



1. All linear dimensions are in millimeters.
2. Package weight approximately 0.12 grams
3. Molded plastic case UL 94V-0 rated
4. For Tape and Reel specifications refer to InterFET CTC-021 Tape and Reel Specification, Document number: IF39002
5. Bulk product is shipped in standard ESD shipping material
6. Refer to JEDEC standards for additional information.

Suggested Pad Layout



1. All linear dimensions are in millimeters.
2. The suggested land pattern dimensions have been provided for reference only. A more robust pattern may be desired for wave soldering.

TO-18 Mechanical and Layout Data

Package Outline Data

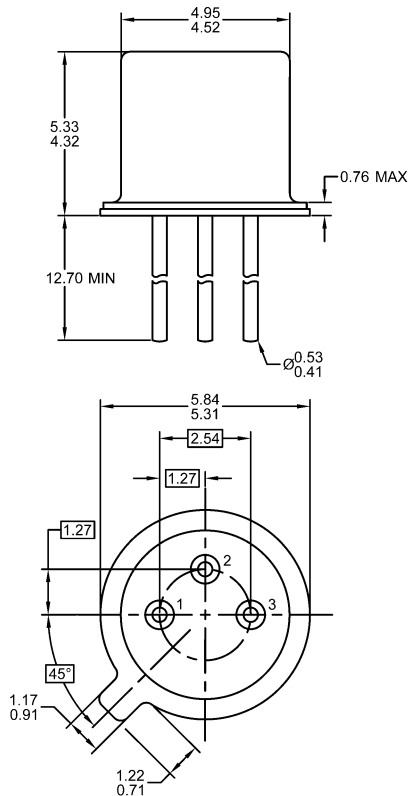

1. All linear dimensions are in millimeters.
2. Package weight approximately 0.29 grams
3. Bulk product is shipped in standard ESD shipping material
4. Refer to JEDEC standards for additional information.

Suggested Through-Hole Layout

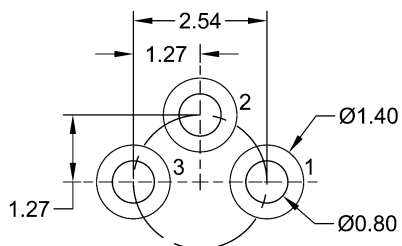

1. All linear dimensions are in millimeters.
2. The suggested land pattern dimensions have been provided as a straight lead reference only. A more robust pattern may be desired for wave soldering and/or bent lead configurations.