

2N4340, 2N4341 N-Channel JFET

Features

- InterFET [N0016SH Geometry](#)
- Low Noise: 4.2 nV/√Hz Typical
- High Gain: 3.1mS Typical (2N4341)
- RoHS Compliant
- SMT, TH, and Bare Die Package options.

Applications

- Audio Amplifiers
- Small Signal Amplifier
- Ultrahigh Impedance Pre-Amplifier
- Voltage Controlled Resistor
- Current Limiters and Regulators

Description

The -50V InterFET 2N4340 and 2N4341 are targeted for sensitive amplifier stages for mid-frequencies designs. Gate leakages are typically less than 10pA at room temperatures. The TO-18 package is hermetically sealed and suitable for military applications.

TO-18 Bottom View

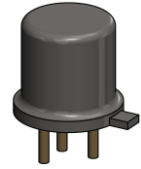
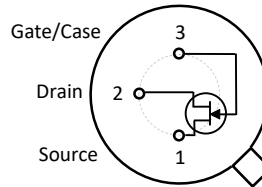

SOT23 Top View



TO-92 Bottom View

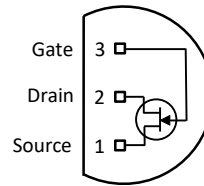

Product Summary

Parameters	2N4340 Min	2N4341 Min	Unit
BV_{GSS} Gate to Source Breakdown Voltage	-50	-50	V
I_{DSS} Drain to Source Saturation Current	1.2	3	mA
$V_{GS(off)}$ Gate to Source Cutoff Voltage	-1	-2	V
G_{FS} Forward Transconductance	1300	2000	μS

Ordering Information Custom Part and Binning Options Available

Part Number	Description	Case	Packaging
2N4340; 2N4341	Through-Hole	TO-18	Bulk
PN4340; PN4341	Through-Hole	TO-92	Bulk
SMP4340; SMP4341	Surface Mount	SOT23	Bulk
SMP4340TR; SMP4341TR	7" Tape and Reel: Max 3,000 Pieces 13" Tape and Reel: Max 9,000 Pieces	SOT23	Minimum 1,000 Pieces Tape and Reel
2N4340COT; 2N4341COT	Chip Orientated Tray (COT Waffle Pack)	COT	400/Waffle Pack
2N4340CFT; 2N4341CFT	Chip Face-up Tray (CFT Waffle Pack)	CFT	400/Waffle Pack



Disclaimer: It is the Buyers responsibility for designing, validating and testing the end application under all field use cases and extreme use conditions. Guaranteeing the application meets required standards, regulatory compliance, and all safety and security requirements is the responsibility of the Buyer. These resources are subject to change without notice.

Electrical Characteristics

Maximum Ratings (@ T_A = 25°C, Unless otherwise specified)

Parameters	Value	Unit
V _{RGS} Reverse Gate Source and Gate Drain Voltage	-50	V
I _{FG} Continuous Forward Gate Current	50	mA
P _D Continuous Device Power Dissipation	300	mW
P Power Derating	2	mW/°C
T _J Operating Junction Temperature	-55 to 125	°C
T _{STG} Storage Temperature	-65 to 175	°C

Static Characteristics (@ T_A = 25°C, Unless otherwise specified)

Parameters	Conditions	2N4340		2N4341		Unit
		Min	Max	Min	Max	
V _{(BR)GSS} Gate to Source Breakdown Voltage	V _{DS} = 0V, I _G = -1μA	-50		-50		V
I _{GSS} Gate to Source Reverse Current	V _{GS} = -30V, V _{DS} = 0V, T _A = 25°C V _{GS} = -30V, V _{DS} = 0V, T _A = 150°C		-0.1 -100		-0.1 -100	nA
V _{GS(OFF)} Gate to Source Cutoff Voltage	V _{DS} = 15V, I _D = 0.1μA	-1	-3	-2	-6	V
I _{DSS} Drain to Source Saturation Current	V _{GS} = 0V, V _{DS} = 15V (Pulsed)	1.2	3.6	3	9	mA
I _{D(OFF)} Drain Cutoff Current	V _{DS} = 15V, V _{GS} = ()		0.05 (-5)		0.07 (-10)	nA V

Dynamic Characteristics (@ T_A = 25°C, Unless otherwise specified)

Parameters	Conditions	2N4340		2N4341		Unit
		Min	Max	Min	Max	
G _{FS} Forward Transconductance	V _{DS} = 15V, V _{GS} = 0V, f = 1kHz	1300	3000	2000	4000	μS
G _{OS} Output Conductance	V _{DS} = 15V, V _{GS} = 0V, f = 1kHz		30		60	μS
R _{DS(ON)} Drain to Source ON Resistance	V _{GS} = 0V, I _D = 0A, f = 1kHz		1500		800	Ω
C _{iss} Input Capacitance	V _{DS} = 15V, V _{GS} = 0V, f = 1MHz		7		7	pF
C _{rss} Reverse Transfer Capacitance	V _{DS} = 15V, V _{GS} = 0V, f = 1MHz		3		3	pF
NF Noise Figure	V _{DS} = 15V, V _{GS} = 0V, f = 1kHz R _G = 1 MΩ, BW = 200 Hz		1		1	dB

Typical 2N4340, 2N4341 Characteristics

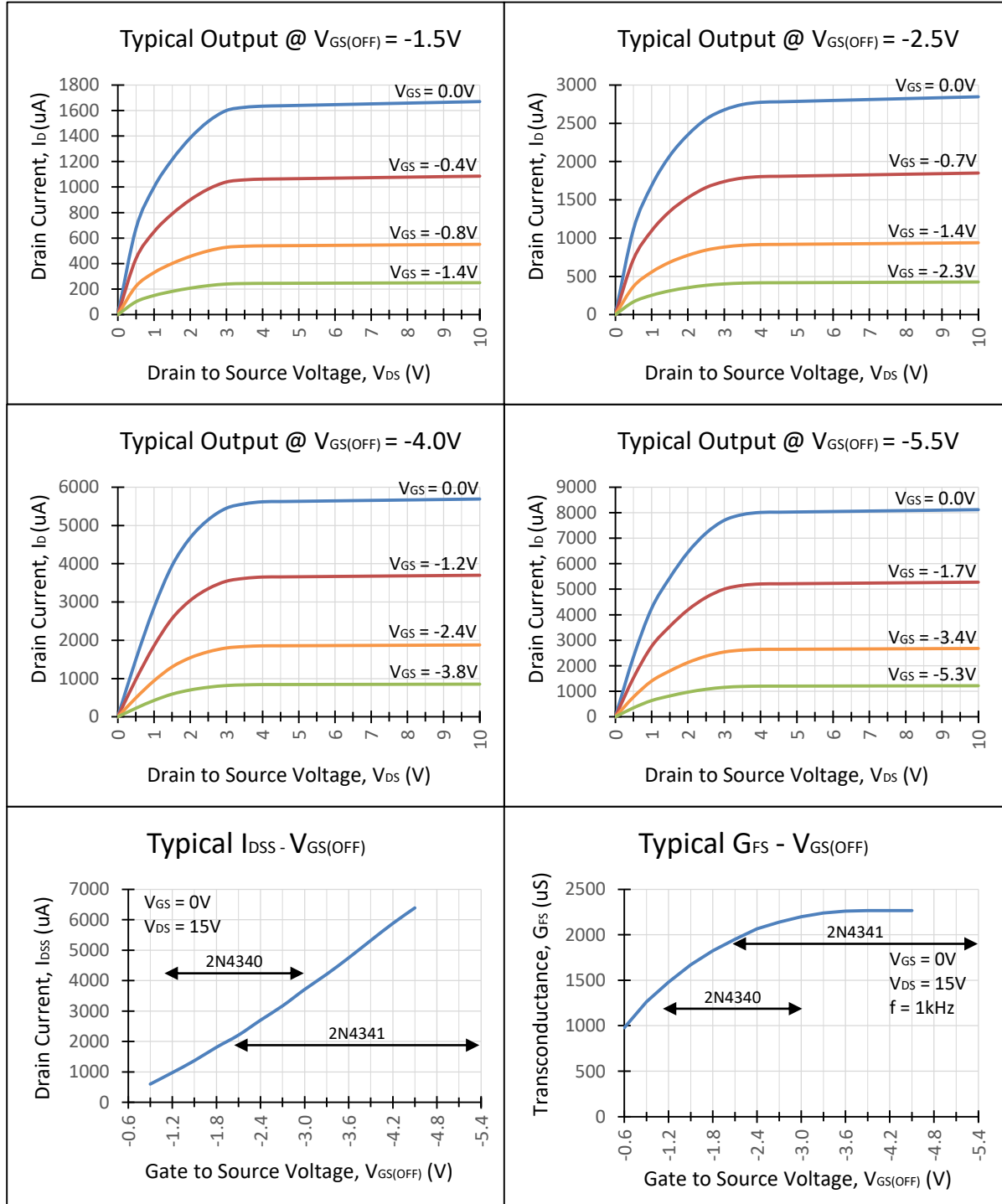

Typical 2N4340, 2N4341 Characteristics (Continued)

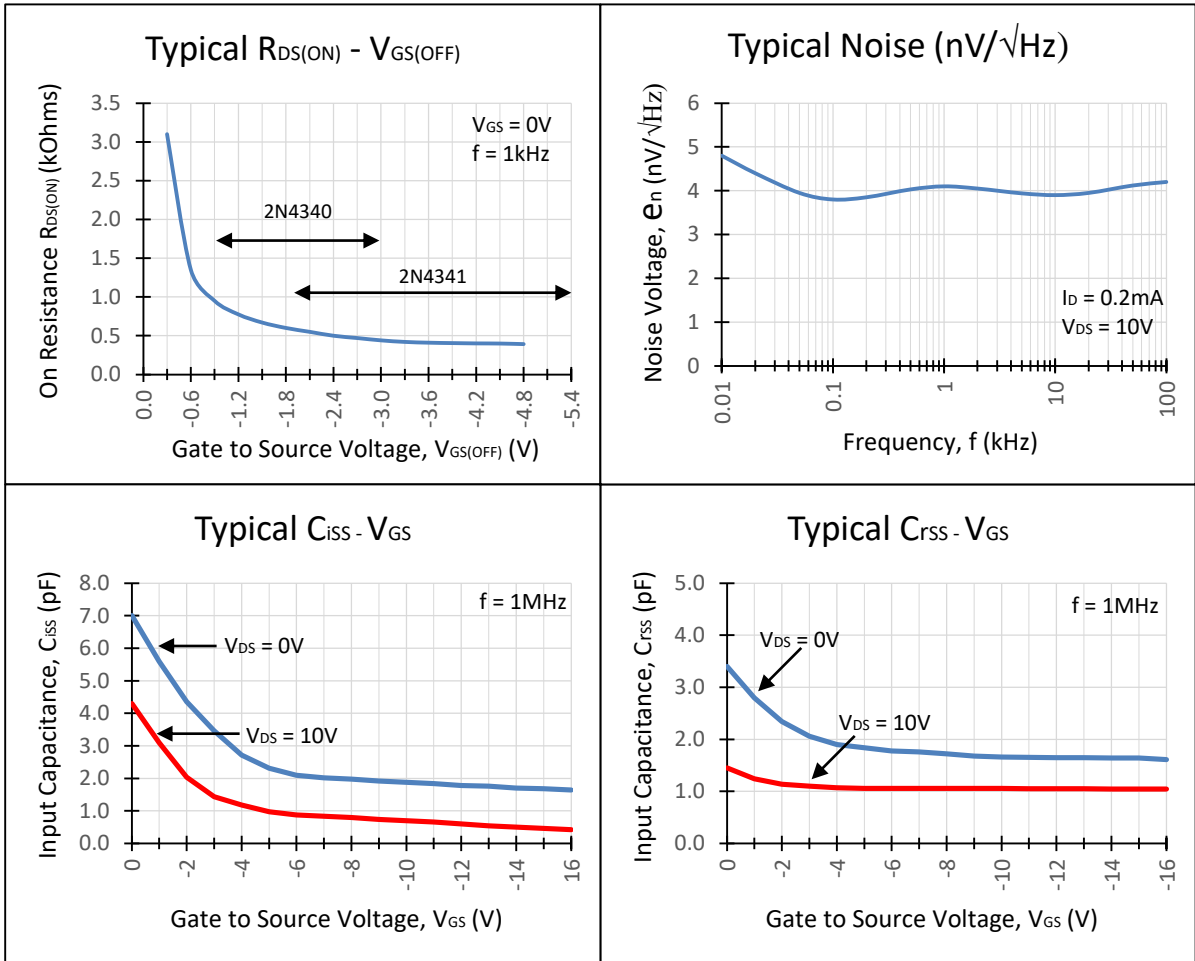

SOT23 (TO-236AB) Mechanical and Layout Data

Package Outline Data

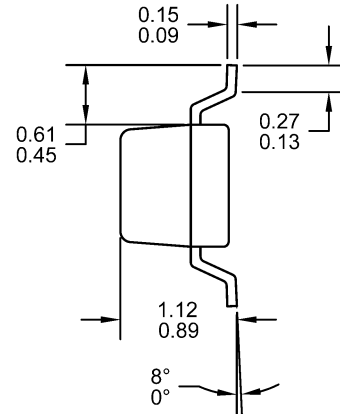

1. All linear dimensions are in millimeters.
2. Package weight approximately 0.12 grams
3. Molded plastic case UL 94V-0 rated
4. For Tape and Reel specifications refer to InterFET CTC-021 Tape and Reel Specification, Document number: IF39002
5. Bulk product is shipped in standard ESD shipping material
6. Refer to JEDEC standards for additional information.

Suggested Pad Layout



1. All linear dimensions are in millimeters.
2. The suggested land pattern dimensions have been provided for reference only. A more robust pattern may be desired for wave soldering.

TO-18 Mechanical and Layout Data

Package Outline Data

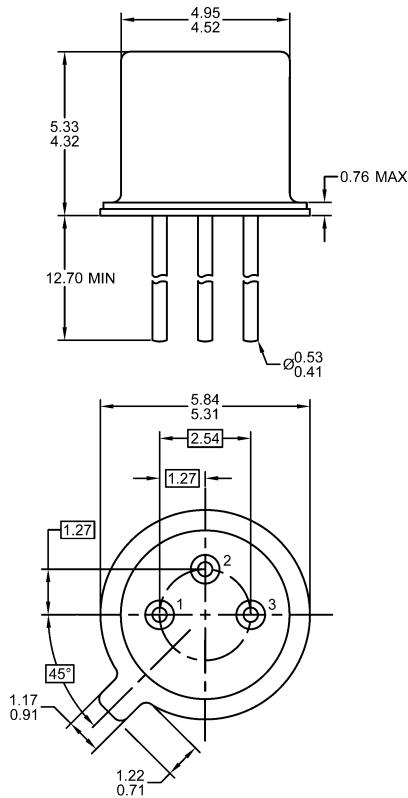

1. All linear dimensions are in millimeters.
2. Package weight approximately 0.29 grams
3. Bulk product is shipped in standard ESD shipping material
4. Refer to JEDEC standards for additional information.

Suggested Through-Hole Layout

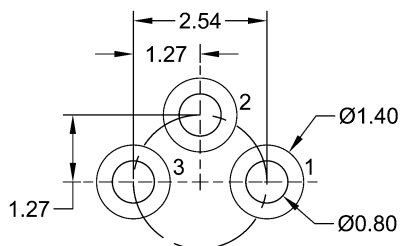

1. All linear dimensions are in millimeters.
2. The suggested land pattern dimensions have been provided as a straight lead reference only. A more robust pattern may be desired for wave soldering and/or bent lead configurations.