

## 2N4416, 2N4416A N-Channel JFET

### Features

- InterFET [N0026S Geometry](#)
- Low Noise: 4 nV/√Hz Typical
- Low Leakage: 10pA Typical
- RoHS Compliant
- SMT, TH, and Bare Die Package options.

### Applications

- Mixers
- VHF Amplifiers

### Description

The -30V InterFET 2N4416 and 2N4416A are targeted for sensitive mixer and VHF Amplifier amplifier designs. Gate leakages are typically less than 10pA at room temperatures. The “A” variant has a higher breakdown Voltage. The TO-72 package is hermetically sealed and suitable for military applications.

TO-72 Bottom View

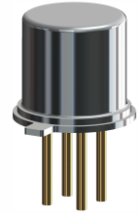
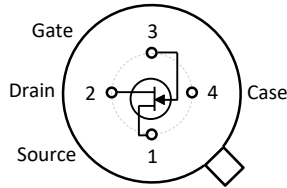

SOT23 Top View

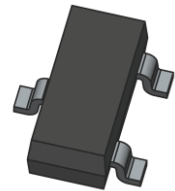
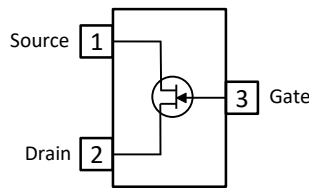

TO-92 Bottom View

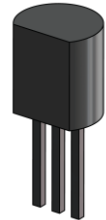
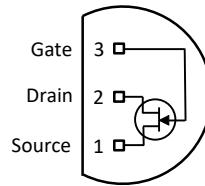

### Product Summary

Parameters	2N4416 Min	2N4416A Min	Unit
$BV_{GSS}$ Gate to Source Breakdown Voltage	-30	-35	V
$I_{DSS}$ Drain to Source Saturation Current	5	5	mA
$V_{GS(off)}$ Gate to Source Cutoff Voltage		-2.5	V
$G_{FS}$ Forward Transconductance	4500	4500	$\mu S$

### Ordering Information Custom Part and Binning Options Available

Part Number	Description	Case	Packaging
2N4416; 2N4416A	Through-Hole	TO-72	Bulk
PN4416; PN4416A	Through-Hole	TO-92	Bulk
SMP4416; SMP4416A	Surface Mount	SOT23	Bulk
SMP4416TR; SMP4416ATR	7" Tape and Reel: Max 3,000 Pieces 13" Tape and Reel: Max 9,000 Pieces	SOT23	Minimum 1,000 Pieces Tape and Reel
2N4416COT; 2N4416ACOT	Chip Orientated Tray (COT Waffle Pack)	COT	400/Waffle Pack
2N4416CFT; 2N4416ACFT	Chip Face-up Tray (CFT Waffle Pack)	CFT	400/Waffle Pack



**Disclaimer:** It is the Buyers responsibility for designing, validating and testing the end application under all field use cases and extreme use conditions. Guaranteeing the application meets required standards, regulatory compliance, and all safety and security requirements is the responsibility of the Buyer. These resources are subject to change without notice.

## Electrical Characteristics

### Maximum Ratings (@ $T_A = 25^\circ\text{C}$ , Unless otherwise specified, Highlighted values = A variant)

Parameters	Value	Unit
$V_{RGS}$ Reverse Gate Source and Gate Drain Voltage	-30	V
	-35	
$I_{FG}$ Continuous Forward Gate Current	10	mA
$P_D$ Continuous Device Power Dissipation	300	mW
$P$ Power Derating	2	mW/ $^\circ\text{C}$
$T_J$ Operating Junction Temperature	-55 to 125	$^\circ\text{C}$
$T_{STG}$ Storage Temperature	-65 to 150	$^\circ\text{C}$

### Static Characteristics (@ $T_A = 25^\circ\text{C}$ , Unless otherwise specified)

Parameters	Conditions	2N4416		2N4416A		Unit
		Min	Max	Min	Max	
$V_{(BR)GSS}$ Gate to Source Breakdown Voltage	$V_{DS} = 0V, I_G = -1\mu\text{A}$	-30		-35		V
$I_{GSS}$ Gate to Source Reverse Current	$V_{GS} = -20V, V_{DS} = 0V, T_A = 25^\circ\text{C}$		-0.1		-0.1	nA
	$V_{GS} = -20V, V_{DS} = 0V, T_A = 150^\circ\text{C}$		-0.1		-0.1	$\mu\text{A}$
$V_{GS(OFF)}$ Gate to Source Cutoff Voltage	$V_{DS} = 15V, I_D = 1\text{mA}$		-6	-2.5	-6	V
$I_{DSS}$ Drain to Source Saturation Current	$V_{GS} = 0V, V_{DS} = 15V$ (Pulsed)	5	15	5	15	mA

### Dynamic Characteristics (@ $T_A = 25^\circ\text{C}$ , Unless otherwise specified)

Parameters	Conditions	2N4416		2N4416A		Unit
		Min	Max	Min	Max	
$G_{FS}$ Forward Transconductance	$V_{DS} = 15V, V_{GS} = 0V, f = 1\text{kHz}$	4500	7500	4500	7500	$\mu\text{S}$
	$V_{DS} = 15V, V_{GS} = 0V, f = 400\text{MHz}$	4000		4000		
$G_{OS}$ Output Conductance	$V_{DS} = 15V, V_{GS} = 0V, f = 1\text{kHz}$		50		50	$\mu\text{S}$
	$V_{DS} = 15V, V_{GS} = 0V, f = 100\text{MHz}$		75		75	
	$V_{DS} = 15V, V_{GS} = 0V, f = 400\text{MHz}$		100		100	
$C_{iss}$ Input Capacitance	$V_{DS} = 15V, V_{GS} = 0V, f = 1\text{MHz}$		4		4	pF
$C_{oss}$ Output Capacitance	$V_{DS} = 15V, V_{GS} = 0V, f = 1\text{MHz}$		2		2	pF
$C_{rss}$ Reverse Transfer Capacitance	$V_{DS} = 15V, V_{GS} = 0V, f = 1\text{MHz}$		0.8		0.8	pF
$G_{is}$ Input Conductance	$V_{DS} = 15V, V_{GS} = 0V, f = 100\text{MHz}$		100		100	$\mu\text{S}$
	$V_{DS} = 15V, V_{GS} = 0V, f = 400\text{MHz}$		1000		1000	
$b_{is}$ Input Susceptance	$V_{DS} = 15V, V_{GS} = 0V, f = 100\text{MHz}$		2500		2500	$\mu\text{S}$
	$V_{DS} = 15V, V_{GS} = 0V, f = 400\text{MHz}$		10000		10000	
$b_{os}$ Output Susceptance	$V_{DS} = 15V, V_{GS} = 0V, f = 100\text{MHz}$		1000		1000	$\mu\text{S}$
	$V_{DS} = 15V, V_{GS} = 0V, f = 400\text{MHz}$		4000		4000	
$G_{ps}$ Power Gain	$V_{DS} = 15V, I_D = 5\text{mA}, f = 100\text{MHz}$	18		18		dB
	$V_{DS} = 15V, I_D = 5\text{mA}, f = 400\text{MHz}$	10		10		
NF Noise Figure	$V_{DS} = 15V, V_{GS} = 0V, f = 100\text{MHz}$		2		2	dB
	$V_{DS} = 15V, V_{GS} = 0V, f = 400\text{MHz}$ $R_G = 1\text{ k}\Omega$		4		4	

## SOT23 (TO-236AB) Mechanical and Layout Data

### Package Outline Data

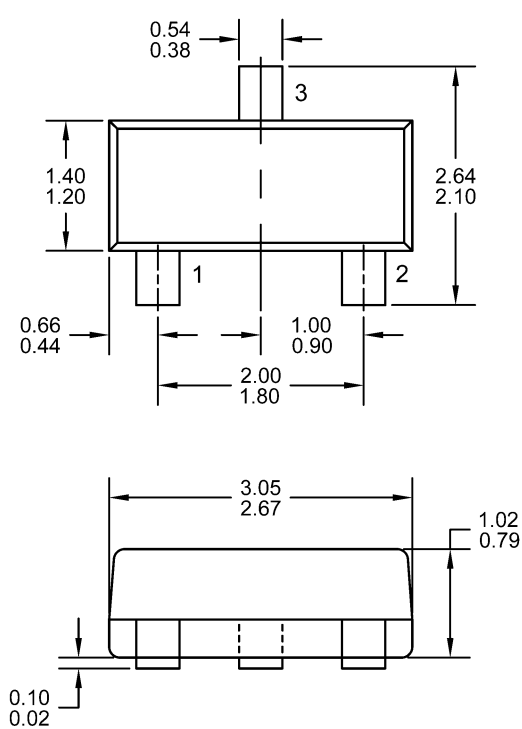

1. All linear dimensions are in millimeters.
2. Package weight approximately 0.12 grams
3. Molded plastic case UL 94V-0 rated
4. For Tape and Reel specifications refer to InterFET CTC-021 Tape and Reel Specification, Document number: IF39002
5. Bulk product is shipped in standard ESD shipping material
6. Refer to JEDEC standards for additional information.

### Suggested Pad Layout

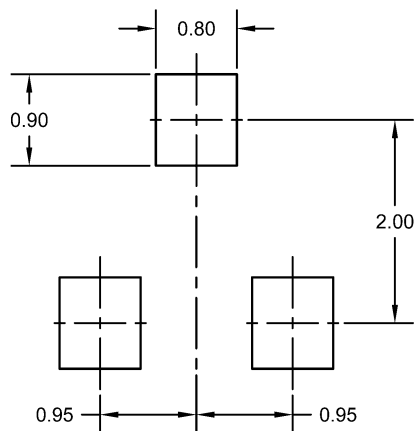

1. All linear dimensions are in millimeters.
2. The suggested land pattern dimensions have been provided for reference only. A more robust pattern may be desired for wave soldering.

