

## 2N4859/A, 2N4860/A, 2N4861/A N-Channel JFET

### Features

- InterFET [N0132S Geometry](#)
- Low Noise: 1.2 nV/√Hz Typical
- Fast Switching
- RoHS Compliant
- SMT, TH, and Bare Die Package options.

### Applications

- Choppers
- Commutators
- Analog Switches

### Description

The -30V InterFET 2N4859/A, 2N4860/A, and 2N4861/A JFET's are targeted for very low noise switching applications for mid to high frequency designs. Gate leakages are typically 50pA at room temperatures. The TO-18 package is hermetically sealed and suitable for military applications.

TO-18 Bottom View

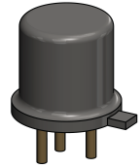
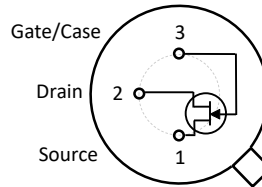

SOT23 Top View

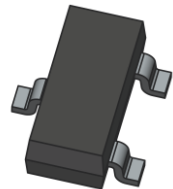

TO-92 Bottom View

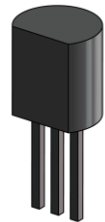
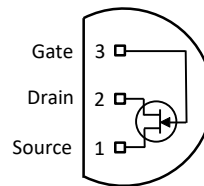

### Product Summary

Parameters	2N4859/A Min	2N4860/A Min	2N4861/A Min	Unit
$BV_{GSS}$ Gate to Source Breakdown Voltage	-30	-30	-30	V
$I_{DSS}$ Drain to Source Saturation Current	50	20	8	mA
$V_{GS(off)}$ Gate to Source Cutoff Voltage	-4	-2	-0.8	V

### Ordering Information Custom Part and Binning Options Available

Part Number	Description	Case	Packaging
2N4859; 2N4860; 2N4861 2N4859A; 2N4860A; 2N4861A	Through-Hole	TO-18	Bulk
PN4859; PN4860; PN4861 PN4859A; PN4860A; PN4861A	Through-Hole	TO-92	Bulk
SMP4859; SMP4860; SMP4861 SMP4859A; SMP4860A; SMP4861A	Surface Mount	SOT23	Bulk
SMP4859TR; SMP4860TR; SMP4861TR SMP4859ATR; SMP4860ATR; SMP4861ATR	7" Tape and Reel: Max 3,000 Pieces 13" Tape and Reel: Max 9,000 Pieces	SOT23	Minimum 1,000 Pieces Tape and Reel
2N4859COT; 2N4860COT; 2N4861COT 2N4859ACOT; 2N4860ACOT; 2N4861ACOT	Chip Orientated Tray (COT Waffle Pack)	COT	400/Waffle Pack
2N4859CFT; 2N4860CFT; 2N4861CFT 2N4859ACFT; 2N4860ACFT; 2N4861ACFT	Chip Face-up Tray (CFT Waffle Pack)	CFT	400/Waffle Pack



**Disclaimer:** It is the Buyers responsibility for designing, validating and testing the end application under all field use cases and extreme use conditions. Guaranteeing the application meets required standards, regulatory compliance, and all safety and security requirements is the responsibility of the Buyer. These resources are subject to change without notice.

## Electrical Characteristics

### Maximum Ratings (@ $T_A = 25^\circ\text{C}$ , Unless otherwise specified)

Parameters	Value	Unit
$V_{RGS}$ Reverse Gate Source and Gate Drain Voltage	-30	V
$I_{FG}$ Continuous Forward Gate Current	50	mA
$P_D$ Continuous Device Power Dissipation	1800	mW
$P$ Power Derating	10	mW/ $^\circ\text{C}$
$T_J$ Operating Junction Temperature	-55 to 125	$^\circ\text{C}$
$T_{STG}$ Storage Temperature	-65 to 150	$^\circ\text{C}$

### Static Characteristics (@ $T_A = 25^\circ\text{C}$ , Unless otherwise specified, Highlighted values = A variant)

Parameters	Conditions	2N4859/A		2N4860/A		2N4861/A		Unit
		Min	Max	Min	Max	Min	Max	
$V_{(BR)GSS}$ Gate to Source Breakdown Voltage	$I_G = -1\mu\text{A}, V_{DS} = 0\text{V}$	-30		-30		-30		V
$I_{GSS}$ Gate to Source Reverse Current	$V_{GS} = -15\text{V}, V_{DS} = 0\text{V}, T_A = 25^\circ\text{C}$ $V_{GS} = -15\text{V}, V_{DS} = 0\text{V}, T_A = 150^\circ\text{C}$		-250 -500		-200 -500		-200 -500	pA nA
$V_{GS(OFF)}$ Gate to Source Cutoff Voltage	$V_{DS} = 15\text{V}, I_D = 0.5\text{nA}$	-4	-10	-2	-6	-0.8	-4	V
$I_{DSS}$ Drain to Source Saturation Current	$V_{DS} = 15\text{V}, V_{GS} = 0\text{V}$ (Pulsed)	50		20	100	8	80	mA
$I_{D(OFF)}$ Drain Cutoff Current	$V_{DS} = 15\text{V}, V_{GS} = -10\text{V}, T_A = 25^\circ\text{C}$ $V_{DS} = 15\text{V}, V_{GS} = -10\text{V}, T_A = 150^\circ\text{C}$		250 500		250 500		250 500	pA nA
$V_{DS(ON)}$ Drain to Source ON Voltage	$V_{GS} = 0\text{V}, I_D = ( )$		0.75 (20)		0.5 (10)		0.5 (5)	V mA

### Dynamic Characteristics (@ $T_A = 25^\circ\text{C}$ , Unless otherwise specified, Highlighted values = A variant)

Parameters	Conditions	2N4859/A		2N4860/A		2N4861/A		Unit
		Min	Max	Min	Max	Min	Max	
$R_{DS(ON)}$ Drain to Source ON Resistance	$V_{GS} = 0\text{V}, I_D = 0\text{A},$ $f = 1\text{kHz}$		25		40		60	$\Omega$
$C_{iss}$ Input Capacitance	$V_{DS} = 0\text{V}, V_{GS} = -10\text{V},$ $f = 1\text{MHz}$		18 10		18 10		18 10	pF
$C_{rss}$ Reverse Transfer Capacitance	$V_{DS} = 0\text{V}, V_{GS} = -10\text{V},$ $f = 1\text{MHz}$		8 4		8 3.5		8 3.5	pF
$t_d$ Turn-On Delay Time	$V_{DD} = 10\text{V}, V_{GS(ON)} = 0\text{V}$ $I_{D(ON)} = ( ), V_{GS(OFF)} = [ ]$		6 5		6 6		10 8	ns
			(20) [-10]		(10) [-6]		(5) [-4]	(mA) [V]
$t_r$ Rise Time	$V_{DD} = 10\text{V}, V_{GS(ON)} = 0\text{V}$ $I_{D(ON)} = ( ), V_{GS(OFF)} = [ ]$		3 3		4 4		10 8	ns
			(20) [-10]		(10) [-6]		(5) [-4]	(mA) [V]
$t_{d(off)}$ Turn-Off Delay Time	$V_{DD} = 10\text{V}, V_{GS(ON)} = 0\text{V}$ $I_{D(ON)} = ( ), V_{GS(OFF)} = [ ]$		25 25		50 40		100 80	ns
			(20) [-10]		(10) [-6]		(5) [-4]	(mA) [V]

## SOT23 (TO-236AB) Mechanical and Layout Data

### Package Outline Data



1. All linear dimensions are in millimeters.
2. Package weight approximately 0.12 grams
3. Molded plastic case UL 94V-0 rated
4. For Tape and Reel specifications refer to InterFET CTC-021 Tape and Reel Specification, Document number: IF39002
5. Bulk product is shipped in standard ESD shipping material
6. Refer to JEDEC standards for additional information.

### Suggested Pad Layout



1. All linear dimensions are in millimeters.
2. The suggested land pattern dimensions have been provided for reference only. A more robust pattern may be desired for wave soldering.

## TO-18 Mechanical and Layout Data

### Package Outline Data

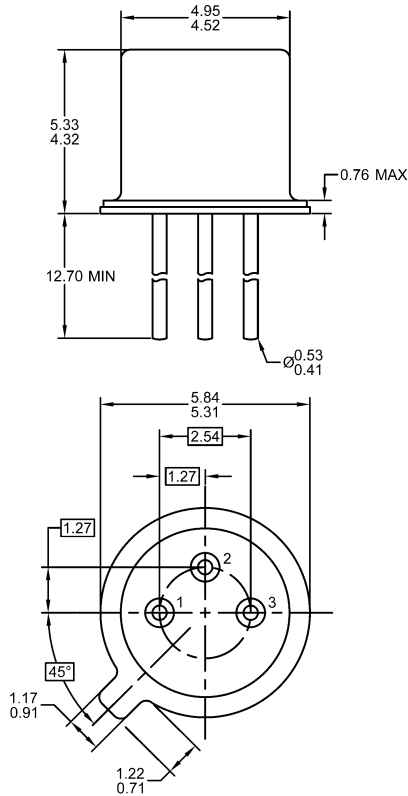

1. All linear dimensions are in millimeters.
2. Package weight approximately 0.29 grams
3. Bulk product is shipped in standard ESD shipping material
4. Refer to JEDEC standards for additional information.

### Suggested Through-Hole Layout

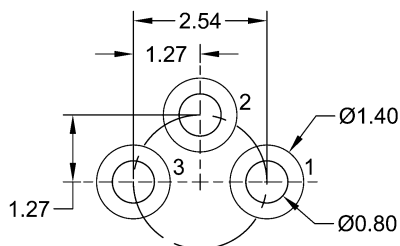

1. All linear dimensions are in millimeters.
2. The suggested land pattern dimensions have been provided as a straight lead reference only. A more robust pattern may be desired for wave soldering and/or bent lead configurations.