

## 2N4859/A, 2N4860/A, 2N4861/A N-Channel JFET

### Features

- InterFET [N0132S Geometry](#)
- Low Noise: 1.2 nV/√Hz Typical
- Fast Switching
- RoHS Compliant
- SMT, TH, and Bare Die Package options.

### Applications

- Choppers
- Commutators
- Analog Switches

### Description

The -30V InterFET 2N4859/A, 2N4860/A, and 2N4861/A JFET's are targeted for very low noise switching applications for mid to high frequency designs. Gate leakages are typically 50pA at room temperatures. The TO-18 package is hermetically sealed and suitable for military applications.

TO-18 Bottom View

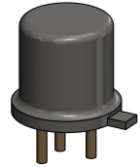
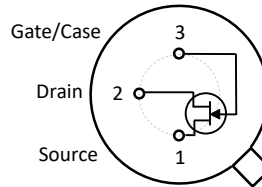

SOT23 Top View

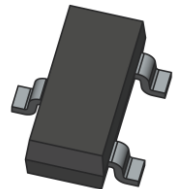
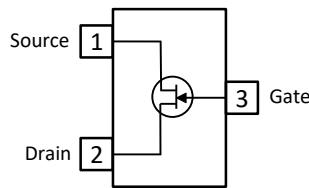

TO-92 Bottom View

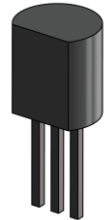
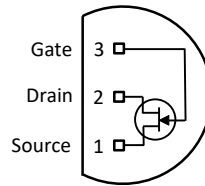

### Product Summary

| Parameters                                   | 2N4859/A Min | 2N4860/A Min | 2N4861/A Min | Unit |
|--|--------------|--------------|--------------|------|
| $BV_{GSS}$ Gate to Source Breakdown Voltage  | -30          | -30          | -30          | V    |
| $I_{DSS}$ Drain to Source Saturation Current | 50           | 20           | 8            | mA   |
| $V_{GS(off)}$ Gate to Source Cutoff Voltage  | -4           | -2           | -0.8         | V    |

### Ordering Information Custom Part and Binning Options Available

| Part Number   | Description   | Case  | Packaging                             |
|---|---|-------|---------------------------------------|
| 2N4859; 2N4860; 2N4861<br>2N4859A; 2N4860A; 2N4861A                   | Through-Hole  | TO-18 | Bulk                                  |
| PN4859; PN4860; PN4861<br>PN4859A; PN4860A; PN4861A                   | Through-Hole  | TO-92 | Bulk                                  |
| SMP4859; SMP4860; SMP4861<br>SMP4859A; SMP4860A; SMP4861A             | Surface Mount   | SOT23 | Bulk                                  |
| SMP4859TR; SMP4860TR; SMP4861TR<br>SMP4859ATR; SMP4860ATR; SMP4861ATR | 7" Tape and Reel: Max 3,000 Pieces<br>13" Tape and Reel: Max 9,000 Pieces | SOT23 | Minimum 1,000 Pieces<br>Tape and Reel |
| 2N4859COT; 2N4860COT; 2N4861COT<br>2N4859ACOT; 2N4860ACOT; 2N4861ACOT | Chip Orientated Tray<br>(COT Waffle Pack)                                 | COT   | 400/Waffle Pack                       |
| 2N4859CFT; 2N4860CFT; 2N4861CFT<br>2N4859ACFT; 2N4860ACFT; 2N4861ACFT | Chip Face-up Tray<br>(CFT Waffle Pack)                                    | CFT   | 400/Waffle Pack                       |



**Disclaimer:** It is the Buyers responsibility for designing, validating and testing the end application under all field use cases and extreme use conditions. Guaranteeing the application meets required standards, regulatory compliance, and all safety and security requirements is the responsibility of the Buyer. These resources are subject to change without notice.

## Electrical Characteristics

### Maximum Ratings (@ $T_A = 25^\circ\text{C}$ , Unless otherwise specified)

| Parameters   | Value      | Unit                 |
|--|------------|----------------------|
| $V_{RGS}$ Reverse Gate Source and Gate Drain Voltage | -30        | V                    |
| $I_{FG}$ Continuous Forward Gate Current             | 50         | mA                   |
| $P_D$ Continuous Device Power Dissipation            | 1800       | mW                   |
| $P$ Power Derating                                   | 10         | mW/ $^\circ\text{C}$ |
| $T_J$ Operating Junction Temperature                 | -55 to 125 | $^\circ\text{C}$     |
| $T_{STG}$ Storage Temperature                        | -65 to 150 | $^\circ\text{C}$     |

### Static Characteristics (@ $T_A = 25^\circ\text{C}$ , Unless otherwise specified, Highlighted values = A variant)

| Parameters                                     | Conditions  | 2N4859/A |              | 2N4860/A |              | 2N4861/A |              | Unit     |
|--|---|----------|--------------|----------|--------------|----------|--------------|----------|
|  |   | Min      | Max          | Min      | Max          | Min      | Max          |          |
| $V_{(BR)GSS}$ Gate to Source Breakdown Voltage | $I_G = -1\mu\text{A}, V_{DS} = 0\text{V}$   | -30      |              | -30      |              | -30      |              | V        |
| $I_{GSS}$ Gate to Source Reverse Current       | $V_{GS} = -15\text{V}, V_{DS} = 0\text{V}, T_A = 25^\circ\text{C}$<br>$V_{GS} = -15\text{V}, V_{DS} = 0\text{V}, T_A = 150^\circ\text{C}$   |          | -250<br>-500 |          | -200<br>-500 |          | -200<br>-500 | pA<br>nA |
| $V_{GS(OFF)}$ Gate to Source Cutoff Voltage    | $V_{DS} = 15\text{V}, I_D = 0.5\text{nA}$   | -4       | -10          | -2       | -6           | -0.8     | -4           | V        |
| $I_{DSS}$ Drain to Source Saturation Current   | $V_{DS} = 15\text{V}, V_{GS} = 0\text{V}$<br>(Pulsed)   | 50       |              | 20       | 100          | 8        | 80           | mA       |
| $I_{D(OFF)}$ Drain Cutoff Current              | $V_{DS} = 15\text{V}, V_{GS} = -10\text{V}, T_A = 25^\circ\text{C}$<br>$V_{DS} = 15\text{V}, V_{GS} = -10\text{V}, T_A = 150^\circ\text{C}$ |          | 250<br>500   |          | 250<br>500   |          | 250<br>500   | pA<br>nA |
| $V_{DS(ON)}$ Drain to Source ON Voltage        | $V_{GS} = 0\text{V}, I_D = ( )$   |          | 0.75<br>(20) |          | 0.5<br>(10)  |          | 0.5<br>(5)   | V<br>mA  |

### Dynamic Characteristics (@ $T_A = 25^\circ\text{C}$ , Unless otherwise specified, Highlighted values = A variant)

| Parameters                                 | Conditions  | 2N4859/A |               | 2N4860/A |              | 2N4861/A |             | Unit        |
|--|---|----------|---------------|----------|--------------|----------|-------------|-------------|
|  |   | Min      | Max           | Min      | Max          | Min      | Max         |             |
| $R_{DS(ON)}$ Drain to Source ON Resistance | $V_{GS} = 0\text{V}, I_D = 0\text{A},$<br>$f = 1\text{kHz}$                           |          | 25            |          | 40           |          | 60          | $\Omega$    |
| $C_{iss}$ Input Capacitance                | $V_{DS} = 0\text{V}, V_{GS} = -10\text{V},$<br>$f = 1\text{MHz}$                      |          | 18<br>10      |          | 18<br>10     |          | 18<br>10    | pF          |
| $C_{rss}$ Reverse Transfer Capacitance     | $V_{DS} = 0\text{V}, V_{GS} = -10\text{V},$<br>$f = 1\text{MHz}$                      |          | 8<br>4        |          | 8<br>3.5     |          | 8<br>3.5    | pF          |
| $t_d$ Turn-On Delay Time                   | $V_{DD} = 10\text{V}, V_{GS(ON)} = 0\text{V}$<br>$I_{D(ON)} = ( ), V_{GS(OFF)} = [ ]$ |          | 6<br>5        |          | 6<br>6       |          | 10<br>8     | ns          |
|  |   |          | (20)<br>[-10] |          | (10)<br>[-6] |          | (5)<br>[-4] | (mA)<br>[V] |
| $t_r$ Rise Time                            | $V_{DD} = 10\text{V}, V_{GS(ON)} = 0\text{V}$<br>$I_{D(ON)} = ( ), V_{GS(OFF)} = [ ]$ |          | 3<br>3        |          | 4<br>4       |          | 10<br>8     | ns          |
|  |   |          | (20)<br>[-10] |          | (10)<br>[-6] |          | (5)<br>[-4] | (mA)<br>[V] |
| $t_{d(off)}$ Turn-Off Delay Time           | $V_{DD} = 10\text{V}, V_{GS(ON)} = 0\text{V}$<br>$I_{D(ON)} = ( ), V_{GS(OFF)} = [ ]$ |          | 25<br>25      |          | 50<br>40     |          | 100<br>80   | ns          |
|  |   |          | (20)<br>[-10] |          | (10)<br>[-6] |          | (5)<br>[-4] | (mA)<br>[V] |

## SOT23 (TO-236AB) Mechanical and Layout Data

### Package Outline Data



1. All linear dimensions are in millimeters.
2. Package weight approximately 0.12 grams
3. Molded plastic case UL 94V-0 rated
4. For Tape and Reel specifications refer to InterFET CTC-021 Tape and Reel Specification, Document number: IF39002
5. Bulk product is shipped in standard ESD shipping material
6. Refer to JEDEC standards for additional information.

### Suggested Pad Layout



1. All linear dimensions are in millimeters.
2. The suggested land pattern dimensions have been provided for reference only. A more robust pattern may be desired for wave soldering.

## TO-18 Mechanical and Layout Data

### Package Outline Data

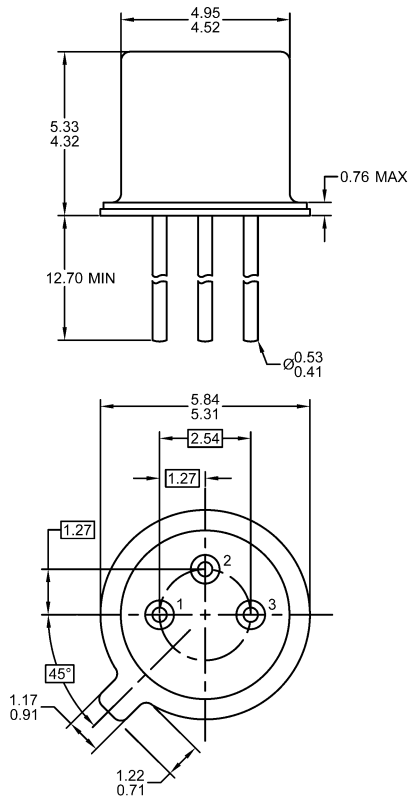

1. All linear dimensions are in millimeters.
2. Package weight approximately 0.29 grams
3. Bulk product is shipped in standard ESD shipping material
4. Refer to JEDEC standards for additional information.

### Suggested Through-Hole Layout

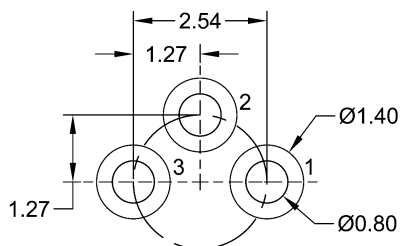

1. All linear dimensions are in millimeters.
2. The suggested land pattern dimensions have been provided as a straight lead reference only. A more robust pattern may be desired for wave soldering and/or bent lead configurations.