

## 2N5114, 2N5115, 2N5116 P-Channel JFET

### Features

- InterFET [P0099F Geometry](#)
- Typical Noise: 8 nV/VHz
- Low  $R_{ds(on)}$
- RoHS Compliant
- SMT, TH, and Bare Die Package options.

### Applications

- Analog Switches
- Choppers

### Description

The 30V InterFET 2N5114, 2N5115, and 2N5116 are targeted for choppers and analog switch designs. The on resistance is typically less than 100 Ohms at room temperatures. The TO-18 package is hermetically sealed and suitable for military applications.

TO-18 Bottom View

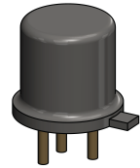
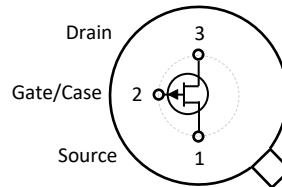

SOT23 Top View

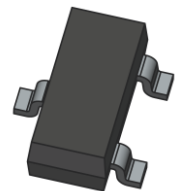
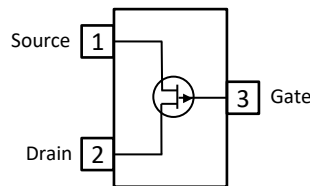

TO-92 Bottom View

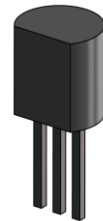
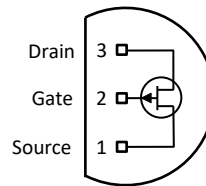

### Product Summary

Parameters	2N5114 Min	2N5115 Min	2N5116 Min	Unit
$BV_{GSS}$ Gate to Source Breakdown Voltage	30	30	30	V
$I_{DSS}$ Drain to Source Saturation Current	-30	-15	-5	mA
$V_{GS(off)}$ Gate to Source Cutoff Voltage	5	3	1	V

### Ordering Information Custom Part and Binning Options Available

Part Number	Description	Case	Packaging
2N5114; 2N5115; 2N5116	Through-Hole	TO-18	Bulk
PN5114; PN5115; PN5116	Through-Hole	TO-92	Bulk
SMP5114; SMP5115; SMP5116	Surface Mount	SOT23	Bulk
SMP5114TR; SMP5115TR SMP5116TR	7" Tape and Reel: Max 3,000 Pieces 13" Tape and Reel: Max 9,000 Pieces	SOT23	Minimum 1,000 Pieces Tape and Reel
2N5114COT; 2N5115COT 2N5116COT	Chip Orientated Tray (COT Waffle Pack)	COT	400/Waffle Pack
2N5114CFT; 2N5115CFT 2N5116CFT	Chip Face-up Tray (CFT Waffle Pack)	CFT	400/Waffle Pack



**Disclaimer:** It is the Buyers responsibility for designing, validating and testing the end application under all field use cases and extreme use conditions. Guaranteeing the application meets required standards, regulatory compliance, and all safety and security requirements is the responsibility of the Buyer. These resources are subject to change without notice.

## Electrical Characteristics

### Maximum Ratings (@ $T_A = 25^\circ\text{C}$ , Unless otherwise specified)

Parameters	Value	Unit
$V_{RGS}$ Reverse Gate Source and Gate Drain Voltage	30	V
$I_{FG}$ Continuous Forward Gate Current	50	mA
$P_D$ Continuous Device Power Dissipation	500	mW
$P$ Power Derating	4	mW/ $^\circ\text{C}$
$T_J$ Operating Junction Temperature	-55 to 125	$^\circ\text{C}$
$T_{STG}$ Storage Temperature	-65 to 200	$^\circ\text{C}$

### Static Characteristics (@ $T_A = 25^\circ\text{C}$ , Unless otherwise specified)

Parameters	Conditions	2N5114		2N5115		2N5116		Unit
		Min	Max	Min	Max	Min	Max	
$V_{(BR)GSS}$ Gate to Source Breakdown Voltage	$V_{DS} = 0V, I_G = -1mA$	30		30		30		V
$I_{GSS}$ Gate to Source Reverse Current	$V_{DS} = 20V, V_{GS} = 0V, T_A = 25^\circ\text{C}$		2		2		2	nA
	$V_{DS} = 20V, V_{GS} = 0V, T_A = 150^\circ\text{C}$		10		10		10	$\mu\text{A}$
$V_{GS(OFF)}$ Gate to Source Cutoff Voltage	$V_{DS} = -15V, I_D = -1nA$	5	10	3	6	1	4	V
$V_{GS(F)}$ Gate to Source Forward Voltage	$V_{DS} = 0V, I_G = -1mA$		-1		-1		-1	V
$I_{DSS}$ Drain to Source Saturation Current	$V_{GS} = 18V, V_{DS} = -15V$	-30	-90					mA
	$V_{GS} = 15V, V_{DS} = -15V$ (Pulsed)			-15	-60	-5	-25	
$I_{D(OFF)}$ Drain Cutoff Current	$V_{DS} = -15V, V_{GS} = 12V, T_A = 25^\circ\text{C}$		-2		-2		-2	nA
	$V_{DS} = -15V, V_{GS} = 7V, T_A = 150^\circ\text{C}$		-10		-10		-10	$\mu\text{A}$
$V_{DS(ON)}$ Drain to Source ON Voltage	$V_{GS} = 0V, I_D = -15mA$		-1.3					V
	$V_{GS} = 0V, I_D = -7mA$				-0.8			
	$V_{GS} = 0V, I_D = -3mA$						-0.6	
$R_{DS(ON)}$ Static Drain to Source ON Resistance	$V_{GS} = 0V, I_D = -1mA$		75		100		150	$\Omega$

### Dynamic Characteristics (@ $T_A = 25^\circ\text{C}$ , Unless otherwise specified)

Parameters	Conditions	2N5114		2N5115		2N5116		Unit
		Min	Max	Min	Max	Min	Max	
$R_{DS(ON)}$ Drain to Source ON Resistance	$V_{GS} = 0V, I_D = 0A, f = 1kHz$		75		100		150	$\Omega$
$C_{iss}$ Input Capacitance	$V_{DS} = -15V, V_{GS} = 0V, f = 1MHz$		25		25		27	pF
$C_{rss}$ Reverse Transfer Capacitance	$V_{DS} = -10V, V_{GS} = 12V, f = 1MHz$		7					pF
	$V_{DS} = -10V, V_{GS} = 7V, f = 1MHz$				7			
	$V_{DS} = -10V, V_{GS} = 5V, f = 1MHz$						7	
$t_{d(ON)}$ Turn-On Delay Time	$V_{DD} = V$		6		10		25	ns
$t_r$ Rise Time	$V_{DD} = V$		10		20		35	ns
$t_{d(OFF)}$ Turn-Off Delay Time	$V_{DD} = V$		6		8		20	ns
$t_f$ Fall Time	$V_{DD} = V$		15		30		60	ns



## TO-18 Mechanical and Layout Data

### Package Outline Data

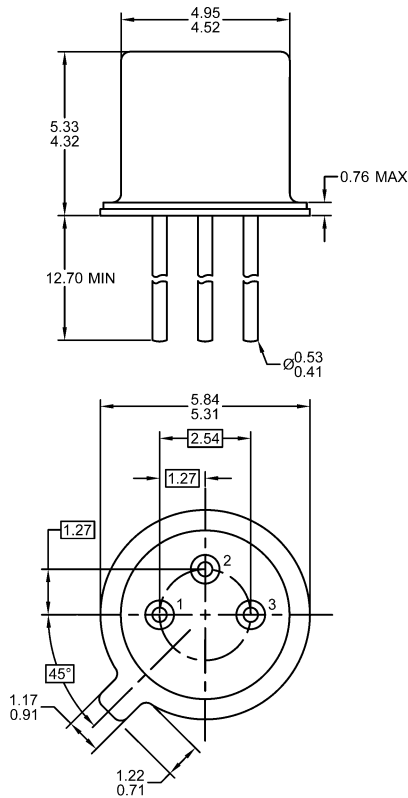

1. All linear dimensions are in millimeters.
2. Package weight approximately 0.29 grams
3. Bulk product is shipped in standard ESD shipping material
4. Refer to JEDEC standards for additional information.

### Suggested Through-Hole Layout

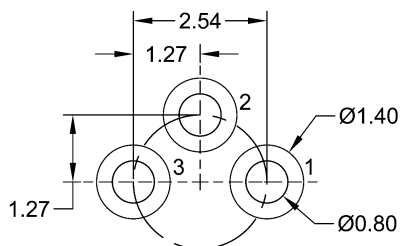

1. All linear dimensions are in millimeters.
2. The suggested land pattern dimensions have been provided as a straight lead reference only. A more robust pattern may be desired for wave soldering and/or bent lead configurations.