

2N6453, 2N6454 N-Channel JFET

Features

- InterFET [N0132L Geometry](#)
- Low noise: 1.0 nV/VHz typical
- High gain: 32mS typical
- Low gate leakage: 750fA typical @10V
- Typical I_{BSS} : 25mA
- Typical V_{GSS} : -35V
- High radiation tolerance
- RoHS, REACH, CMR compliant
- Custom test and binning options available
- SMT, TH, and bare die package options
- Edge case SPICE modeling: [InterFET SPICE](#)

Industry Standard Crosses

- 2SK152, 2SK170, 2N3972, 2N4393, MMBF4393L
- NSVJ3557SA3, NSVJ5908DSG5, NSVJ2394SA3

InterFET Similar Parts

- IF170D, IFN152
- SMP3972, SMP4393

InterFET Dual Parts

- IF389D, IF1322, IF1322A

Applications

- General: Amplifiers; Switches; Voltage regulators; Oscillators; Signal mixers; Noise generators
- Military/Aero: Radar; Communications; Satellites; Missiles guidance; Hydrophone Preamplifiers
- Medical: Medical imaging systems; Medical monitors and recorders; Ultrasound equipment
- Audio: Tone control circuits; Headphone amplifiers; Audio filters; Electret Microphone

Description

The -25V InterFET 2N6453 and 2N6454 are targeted for sensitive amplifier stages for mid-frequencies designs. Gate leakages are typically 750fA at room temperatures. The InterFET proprietary JFET materials and processes result in highest radiation tolerance and lowest leakage JFETs on the market.

Ordering Information

Part Number	Description	Case	Packaging
2N6453; 2N6454	Through-Hole	TO-72	Bulk
PN6453; PN6454	Through-Hole	TO-92	Bulk
SMP6453; SMP6454	Surface Mount	SOT23	Bulk
SMP6453TR; SMP6454TR	7" Tape and Reel: Max 3,000 Pieces 13" Tape and Reel: Max 9,000 Pieces	SOT23	Minimum 1,000 Pieces Tape and Reel
2N6453COT; 2N6454COT	Chip Orientated Tray (COT Waffle Pack)	COT	400/Waffle Pack
2N6453CFT; 2N6454CFT	Chip Face-up Tray (CFT Waffle Pack)	CFT	400/Waffle Pack

TO-72 Bottom View

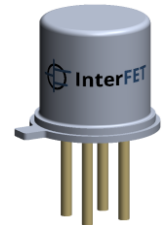
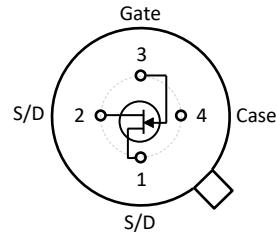

SOT23 Top View

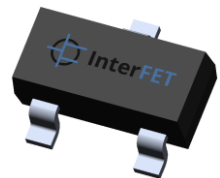
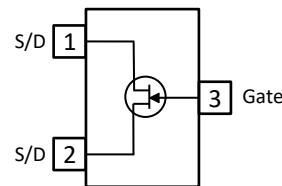

TO-92 Bottom View

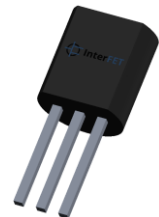
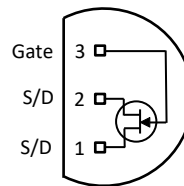

NOTE: S/D pins are interchangeable Source Drain connections



NOTICE: Please refer to the end of this document for information on product materials, compliance, safety, and legal statements.

Electrical Characteristics

Maximum Ratings (@ T_A = 25°C, Unless otherwise specified)

Parameters	TO-72	SOT-23	TO-92	Unit
V _{RGS} Reverse Gate Source and Gate Drain Voltage	-20	-20	-20	V
I _{FG} Continuous Forward Gate Current	10	10	10	mA
P _D Continuous Device Power Dissipation ¹	500	350	500	mW
P Power Derating ¹	3.3	2.8	4	mW/°C
T _J Operating Junction Temperature	-65 to 175	-55 to 150	-55 to 150	°C
T _{STG} Storage Temperature	-65 to 175	-55 to 150	-55 to 150	°C

¹ Thermal power dissipation and derating values obtained with gate pin (substrate) thermally connected to pad and/or internal layer.

Static Characteristics (@ T_A = 25°C, Unless otherwise specified)

Parameters	Conditions	2N6453		2N6454		Unit
		Min	Max	Min	Max	
V _{(BR)GSS} Gate to Source Breakdown Voltage	V _{DS} = 0V, I _G = -1μA	-20		-25		V
I _{GSS} Gate to Source Reverse Current	V _{GS} = -10V, V _{DS} = 0V, T _A = 25°C		-0.1			nA
	V _{GS} = -15V, V _{DS} = 0V, T _A = 25°C				-0.5	
	V _{GS} = -10V, V _{DS} = 0V, T _A = 125°C		-0.2			μA
	V _{GS} = -15V, V _{DS} = 0V, T _A = 125°C				-1	
V _{GS(OFF)} Gate to Source Cutoff Voltage	V _{DS} = 10V, I _D = 0.5nA	-0.75	-5	-0.75	-5	V
I _{DSS} Drain to Source Saturation Current	V _{GS} = 0V, V _{DS} = 10V (Pulsed)	15	50	15	50	mA

Dynamic Characteristics (@ T_A = 25°C, Unless otherwise specified)

Parameters	Conditions	2N6453		2N6454		Unit
		Min	Max	Min	Max	
G _{FS} Forward Transconductance	V _{DS} = 10V, I _D = 15mA, f = 1kHz	20	40	20	40	mS
G _{OS} Output Conductance	V _{DS} = 10V, I _D = 15mA, f = 1kHz		100		100	μS
C _{iss} Input Capacitance	V _{DS} = 10V, I _D = 15mA, f = 1MHz		25		25	pF
C _{rss} Reverse Transfer Capacitance	V _{DS} = 10V, I _D = 15mA, f = 1MHz		5		5	pF
e _n Equivalent Circuit Input Noise Voltage	V _{DS} = 10V, I _D = 5mA, f = 10Hz		5		10	nV/√Hz
	V _{DS} = 10V, I _D = 5mA, f = 1kHz		3		8	
NF Noise Figure	V _{DS} = 10V, I _D = 5mA, f = 10Hz R _G = 10 kΩ		1.5		2.5	dB

Typical 2N6453, 2N6454 Characteristics

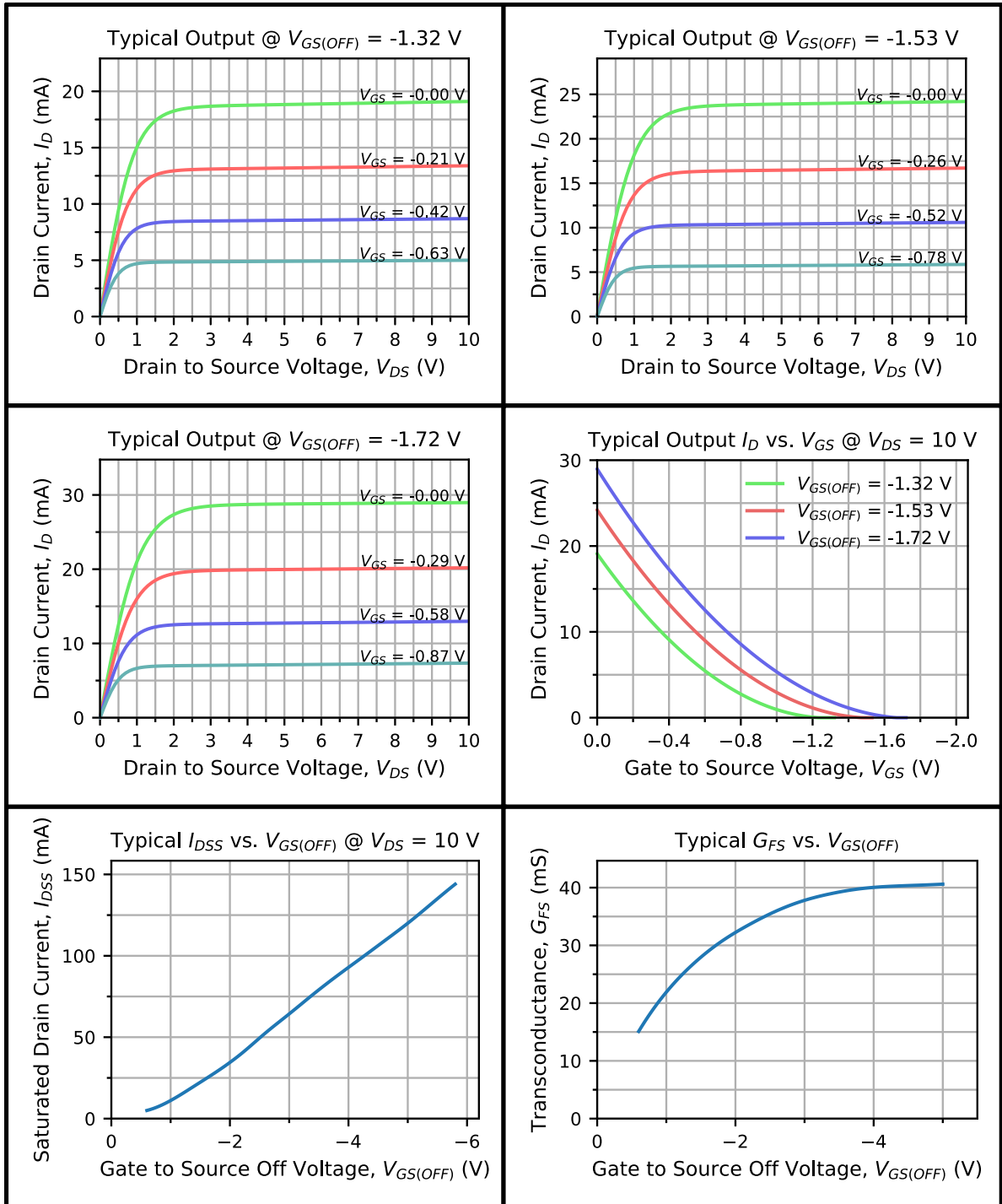

Typical 2N6453, 2N6454 Characteristics (Continued)

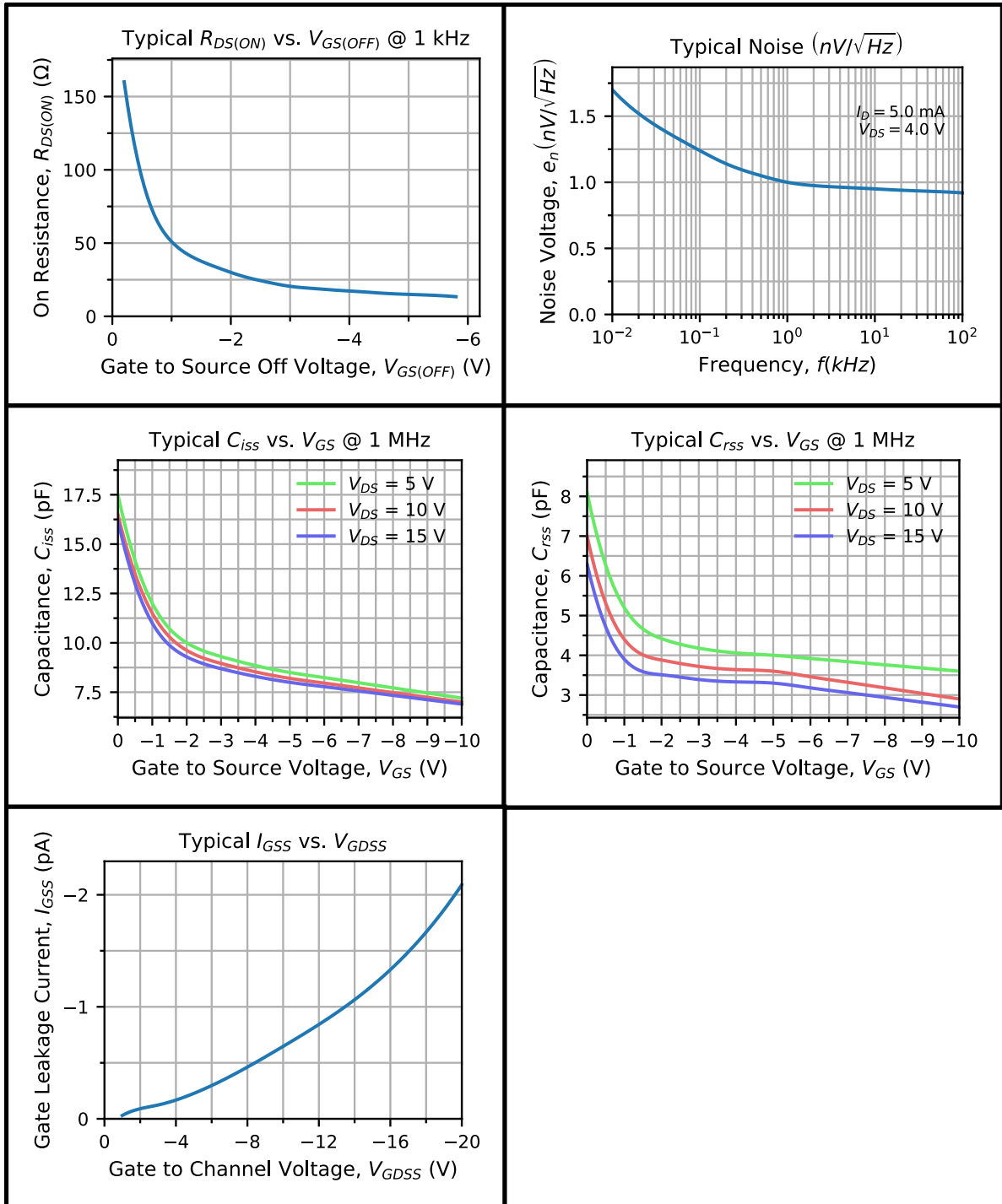

SOT23 (TO-236AB) Mechanical and Layout Data

Package Outline Data



1. All linear dimensions are in millimeters.
2. Package weight approximately 0.12 grams
3. Molded plastic case UL 94V-0 rated
4. For Tape and Reel specifications refer to InterFET CTC-021 Tape and Reel Specification, Document number: IF39002
5. Bulk product is shipped in standard ESD shipping material
6. Refer to JEDEC standards for additional information.

Suggested Pad Layout

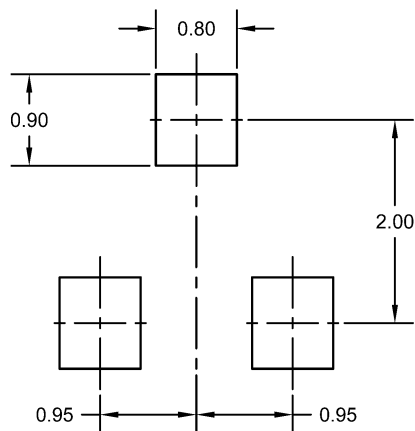

1. All linear dimensions are in millimeters.
2. The suggested land pattern dimensions have been provided for reference only. A more robust pattern may be desired for wave soldering.

TO-72 Mechanical and Layout Data

Package Outline Data

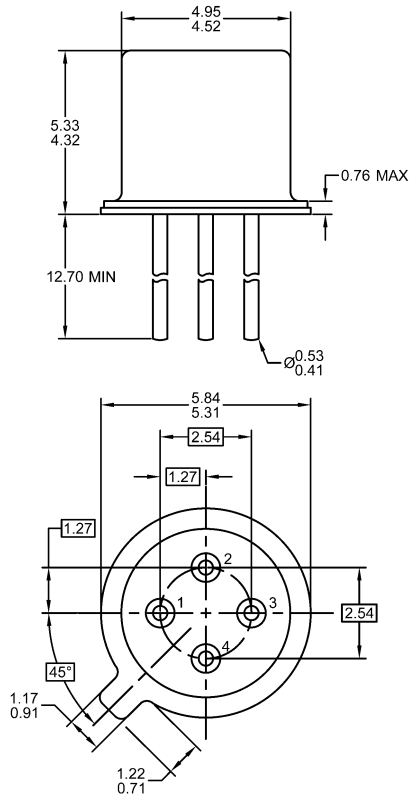

1. All linear dimensions are in millimeters.
2. Four leaded device. Not all leads are shown in drawing views.
3. Package weight approximately 0.31 grams
4. Bulk product is shipped in standard ESD shipping material
5. Refer to JEDEC standards for additional information.

Suggested Through-Hole Layout



1. All linear dimensions are in millimeters.
2. The suggested land pattern dimensions have been provided as a straight lead reference only. A more robust pattern may be desired for wave soldering and/or bent lead configurations.

TO-92 Mechanical and Layout Data

Package Outline Data

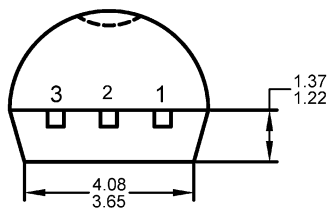
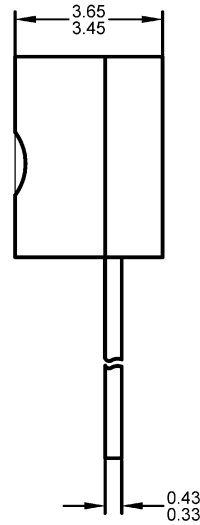
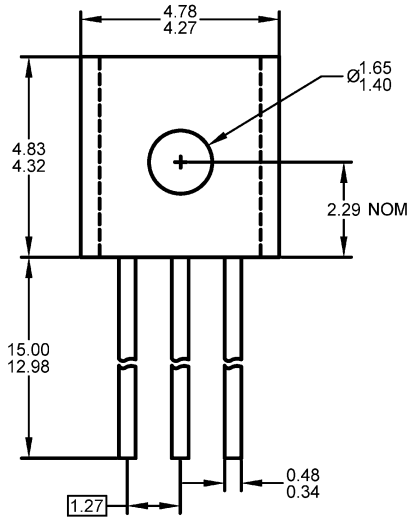

1. All linear dimensions are in millimeters.
2. Package weight approximately 0.19 grams
3. Molded plastic case UL 94V-0 rated
4. Bulk product is shipped in standard ESD shipping material
5. Refer to JEDEC standards for additional information.

Suggested Through-Hole Layout

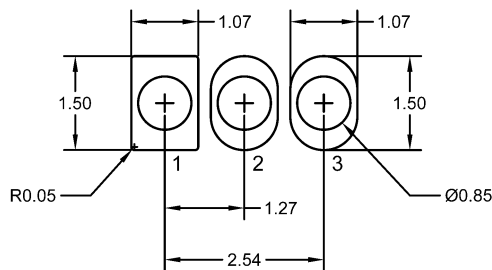

1. All linear dimensions are in millimeters.
2. The suggested land pattern dimensions have been provided as a straight lead reference only. A more robust pattern may be desired for wave soldering and/or bent lead configurations.