

J174, J175 P-Channel JFET

Features

- InterFET [P0099F Geometry](#)
- Low Noise: 8 nV/VHz Typical
- Low $R_{ds(on)}$: 85 Ohms Maximum
- RoHS Compliant
- SMT, TH, and Bare Die Package options.

Applications

- Choppers
- Commutators
- Analog Switches

Description

The 30V InterFET J174 and J175 JFET's are targeted for high gain low noise switching, commutator, and chopper applications.

SOT23 Top View

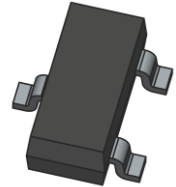
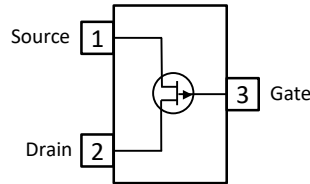

TO-92 Bottom View

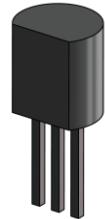
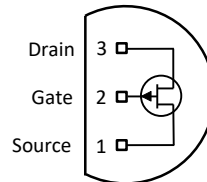

Product Summary

Parameters		J174 Min	J175 Min	Unit
BV_{GSS}	Gate to Source Breakdown Voltage	30	30	V
I_{DSS}	Drain to Source Saturation Current	-20	-7	mA
$V_{GS(off)}$	Gate to Source Cutoff Voltage	5	3	V

Ordering Information Custom Part and Binning Options Available

Part Number	Description	Case	Packaging
J174; J175	Through-Hole	TO-92	Bulk
SMPJ174; SMPJ175	Surface Mount	SOT23	Bulk
SMPJ174TR; SMPJ175TR	7" Tape and Reel: Max 3,000 Pieces 13" Tape and Reel: Max 9,000 Pieces	SOT23	Minimum 1,000 Pieces Tape and Reel
J174COT; J175COT	Chip Orientated Tray (COT Waffle Pack)	COT	400/Waffle Pack
J174CFT; J175CFT	Chip Face-up Tray (CFT Waffle Pack)	CFT	400/Waffle Pack



Disclaimer: It is the Buyers responsibility for designing, validating and testing the end application under all field use cases and extreme use conditions. Guaranteeing the application meets required standards, regulatory compliance, and all safety and security requirements is the responsibility of the Buyer. These resources are subject to change without notice.

Electrical Characteristics

Maximum Ratings (@ $T_A = 25^\circ\text{C}$, Unless otherwise specified)

Parameters	Value	Unit
V_{RGS} Reverse Gate Source and Gate Drain Voltage	30	V
I_{FG} Continuous Forward Gate Current	50	mA
P_D Continuous Device Power Dissipation	360	mW
P Power Derating	3.27	mW/°C
T_J Operating Junction Temperature	-55 to 125	°C
T_{STG} Storage Temperature	-65 to 200	°C

Static Characteristics (@ $T_A = 25^\circ\text{C}$, Unless otherwise specified)

Parameters	Conditions	J174		J175		Unit
		Min	Max	Min	Max	
$V_{(BR)GSS}$ Gate to Source Breakdown Voltage	$V_{DS} = 0V, I_G = 1\mu A$	30		30		V
I_{GSS} Gate to Source Reverse Current	$V_{GS} = 20V, V_{DS} = 0V$		1		1	nA
$V_{GS(OFF)}$ Gate to Source Cutoff Voltage	$V_{DS} = -15V, I_D = -10nA$	5	10	3	6	V
I_{DSS} Drain to Source Saturation Current	$V_{GS} = 0V, V_{DS} = -15V$ (Pulsed)	-20	-125	-7	-70	mA
$I_{D(OFF)}$ Drain Cutoff Current	$V_{DS} = -15V, V_{GS} = 10V$		-1		-1	nA

Dynamic Characteristics (@ $T_A = 25^\circ\text{C}$, Unless otherwise specified)

Parameters	Conditions	J174		J175		Unit
		Min	Max	Min	Max	
$R_{DS(ON)}$ Drain to Source ON Resistance	$V_{DS} \leq 0.1V, V_{GS} = 0V, f = 1kHz$		85		85	Ω
C_{gd} Drain Gate Capacitance	$V_{DS} = 0V, V_{GS} = 10V, f = 1MHz$	5.5 (typ)		5.5 (typ)		pF
C_{gs} Input Capacitance	$V_{DS} = 0V, V_{GS} = 10V, f = 1MHz$	5.5 (typ)		5.5 (typ)		pF
$C_{gd} + C_{gs}$ Drain + Source Gate Capacitance	$V_{DS} = V_{GS} = 0V, f = 1MHz$	32 (typ)		32 (typ)		pF
$t_{d(ON)}$ Turn ON Delay Time	J174: $V_{DD} = -10V, V_{GS(OFF)} = 12V,$ $R_L = 560\Omega$	2 (typ)		5 (typ)		ns
t_r Rise Time		5 (typ)		10 (typ)		ns
$t_{d(OFF)}$ Turn OFF Delay Time	J175: $V_{DD} = -6V, V_{GS(OFF)} = 8V$ $R_L = 1200\Omega$	5 (typ)		10 (typ)		ns
t_f Fall Time		10 (typ)		20 (typ)		ns

SOT23 (TO-236AB) Mechanical and Layout Data

Package Outline Data

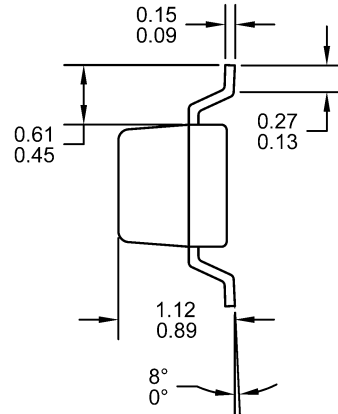
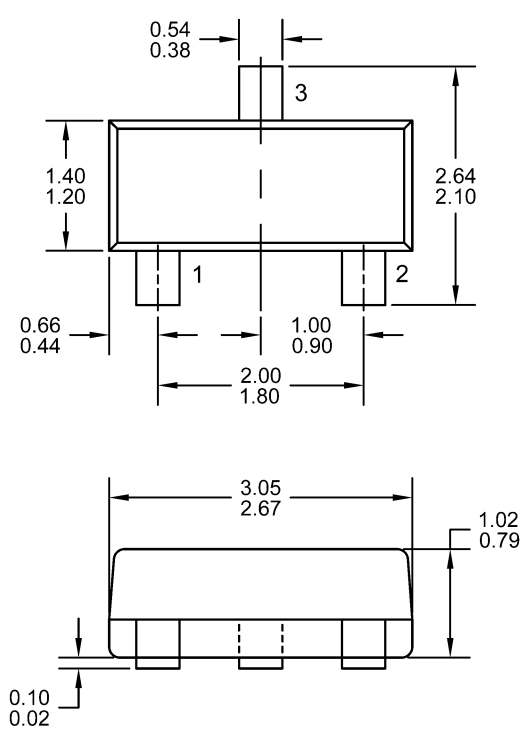

1. All linear dimensions are in millimeters.
2. Package weight approximately 0.12 grams
3. Molded plastic case UL 94V-0 rated
4. For Tape and Reel specifications refer to InterFET CTC-021 Tape and Reel Specification, Document number: IF39002
5. Bulk product is shipped in standard ESD shipping material
6. Refer to JEDEC standards for additional information.

Suggested Pad Layout

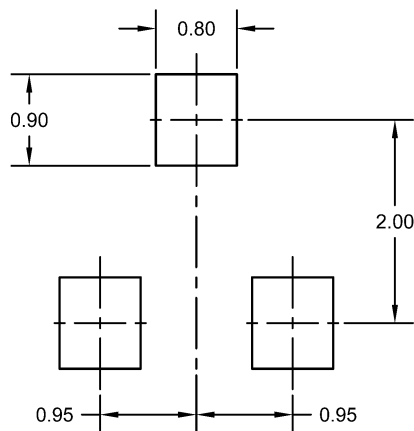

1. All linear dimensions are in millimeters.
2. The suggested land pattern dimensions have been provided for reference only. A more robust pattern may be desired for wave soldering.