

U304, U305, U306 P-Channel JFET

Features

- InterFET [P0099F Geometry](#)
- Typical Noise: 8 nV/VHz
- Fast Switching
- RoHS Compliant
- SMT, TH, and Bare Die Package options.

Applications

- Analog Switch
- Chopper

Description

The 30V InterFET U304, U305, and U306 JFET's are targeted for choppers and switching designs. The on resistance is typically less than 100 Ohms at room temperatures. The TO-72 package is hermetically sealed and suitable for military applications.

TO-18 Bottom View

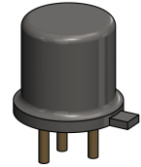
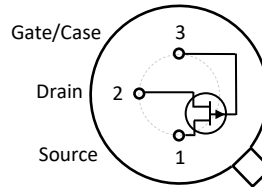

SOT23 Top View

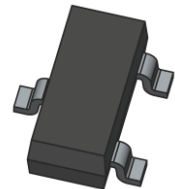
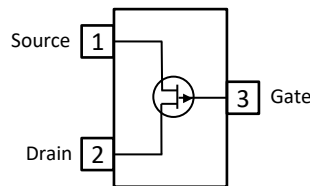

TO-92 Bottom View

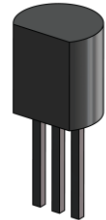
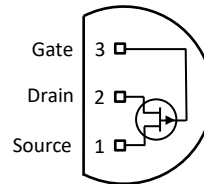

Product Summary

| Parameters | U304 Min | U305 Min | U306 Min | Unit |
|----------------------------------------------|----------|----------|----------|------|
| BV_{GSS} Gate to Source Breakdown Voltage | 30 | 30 | 30 | V |
| I_{DSS} Drain to Source Saturation Current | -30 | -15 | -5 | mA |
| $V_{GS(off)}$ Gate to Source Cutoff Voltage | 5 | 3 | 1 | V |

Ordering Information Custom Part and Binning Options Available

| Part Number | Description | Case | Packaging |
|---------------------------------|---------------------------------------------------------------------------|-------|---------------------------------------|
| U304; U305; U306 | Through-Hole | TO-18 | Bulk |
| PNU304; PNU305; PNU306 | Through-Hole | TO-92 | Bulk |
| SMPU304; SMPU305; SMPU306 | Surface Mount | SOT23 | Bulk |
| SMPU304TR; SMPU305TR; SMPU306TR | 7" Tape and Reel: Max 3,000 Pieces 13" Tape and Reel: Max 9,000 Pieces | SOT23 | Minimum 1,000 Pieces Tape and Reel |
| U304COT; U305COT; U306COT | Chip Orientated Tray (COT Waffle Pack) | COT | 400/Waffle Pack |
| U304CFT; U305CFT; U306CFT | Chip Face-up Tray (CFT Waffle Pack) | CFT | 400/Waffle Pack |



Disclaimer: It is the Buyers responsibility for designing, validating and testing the end application under all field use cases and extreme use conditions. Guaranteeing the application meets required standards, regulatory compliance, and all safety and security requirements is the responsibility of the Buyer. These resources are subject to change without notice.

Electrical Characteristics

Maximum Ratings (@ $T_A = 25^\circ\text{C}$, Unless otherwise specified)

| Parameters | Value | Unit |
|------------------------------------------------------|------------|----------------------|
| V_{RGS} Reverse Gate Source and Gate Drain Voltage | 30 | V |
| I_{FG} Continuous Forward Gate Current | -50 | mA |
| P_D Continuous Device Power Dissipation | 350 | mW |
| P Power Derating | 2.8 | mW/ $^\circ\text{C}$ |
| T_J Operating Junction Temperature | -55 to 125 | $^\circ\text{C}$ |
| T_{STG} Storage Temperature | -65 to 150 | $^\circ\text{C}$ |

Static Characteristics (@ $T_A = 25^\circ\text{C}$, Unless otherwise specified)

| Parameters | Conditions | U304 | | U305 | | U306 | | Unit |
|------------------------------------------------|-----------------------------------------------------------------------------------------------------------------|------|--------------------|------|-------------------|------|-------------------|--------------------------|
| | | Min | Max | Min | Max | Min | Max | |
| $V_{(BR)GSS}$ Gate to Source Breakdown Voltage | $V_{DS} = 0V, I_G = 1\mu\text{A}$ | 30 | | 30 | | 30 | | V |
| I_{GSS} Gate to Source Reverse Current | $V_{GS} = 20V, V_{DS} = 0V, T_A = 25^\circ\text{C}$ $V_{GS} = 20V, V_{DS} = 0V, T_A = 125^\circ\text{C}$ | | 500 1 | | 500 1 | | 500 1 | pA μA |
| $V_{GS(OFF)}$ Gate to Source Cutoff Voltage | $V_{DS} = -15V, I_D = -1\mu\text{A}$ | 5 | 10 | 3 | 6 | 1 | 4 | V |
| $I_{D(OFF)}$ Drain Cutoff Current | $V_{DG} = -15V, V_{GS} = (), T_A = 25^\circ\text{C}$ $V_{DG} = -15V, V_{GS} = (), T_A = 125^\circ\text{C}$ | | -500 -1 (12) | | -500 -1 (7) | | -500 -1 (3) | nA μA V |
| I_{DSS} Drain to Source Saturation Current | $V_{DS} = -15V, V_{GS} = 0V$ (Pulsed) | -30 | -90 | -15 | -60 | -5 | -25 | mA |
| $V_{DS(ON)}$ Drain to Source ON Voltage | $V_{GS} = 0V, I_D = ()$ | | -1.3 (-15) | | -0.8 (-7) | | -0.6 (-5) | V mA |

Dynamic Characteristics (@ $T_A = 25^\circ\text{C}$, Unless otherwise specified)

| Parameters | Conditions | U304 | | U305 | | U306 | | Unit |
|--------------------------------------------|-----------------------------------------------------------------------------------------------------------------------------------------------------------------------------------------------------------------------------------------------------------------------------------------------------------------------|------|-----------|------|----------|------|----------|----------|
| | | Min | Max | Min | Max | Min | Max | |
| $R_{DS(ON)}$ Drain to Source ON Resistance | $I_D = 0A, V_{GS} = 0V, f = 1\text{kHz}$ | | 85 | | 110 | | 175 | Ω |
| C_{iss} Input Capacitance | $V_{DS} = -15V, V_{GS} = 0V, f = 1\text{MHz}$ | | 27 | | 27 | | 27 | pF |
| C_{rss} Reverse Transfer Capacitance | $V_{DS} = 0V, V_{GS} = (), f = 1\text{MHz}$ | | 7 (12) | | 7 (7) | | 7 (5) | pF V |
| $t_{d(ON)}$ Turn ON Delay Time | $V_{GS(ON)} = 0V$ U304: $V_{DD} = -10V, V_{GS(OFF)} = 12V,$ $R_L = 580\Omega, I_{D(ON)} = -15\text{mA}$ U305: $V_{DD} = -6V, V_{GS(OFF)} = 7V,$ $R_L = 743\Omega, I_{D(ON)} = -7\text{mA}$ U306: $V_{DD} = -6V, V_{GS(OFF)} = 5V,$ $R_L = 1800\Omega, I_{D(ON)} = -3\text{mA}$ | | 20 | | 25 | | 25 | nS |
| t_r Rise Time | | | 15 | | 25 | | 35 | nS |
| t_f Fall Time | | | 25 | | 40 | | 60 | nS |
| $t_{d(OFF)}$ Turn OFF Delay Time | | | 10 | | 15 | | 20 | nS |

SOT23 (TO-236AB) Mechanical and Layout Data

Package Outline Data



1. All linear dimensions are in millimeters.
2. Package weight approximately 0.12 grams
3. Molded plastic case UL 94V-0 rated
4. For Tape and Reel specifications refer to InterFET CTC-021 Tape and Reel Specification, Document number: IF39002
5. Bulk product is shipped in standard ESD shipping material
6. Refer to JEDEC standards for additional information.

Suggested Pad Layout



1. All linear dimensions are in millimeters.
2. The suggested land pattern dimensions have been provided for reference only. A more robust pattern may be desired for wave soldering.

TO-18 Mechanical and Layout Data

Package Outline Data

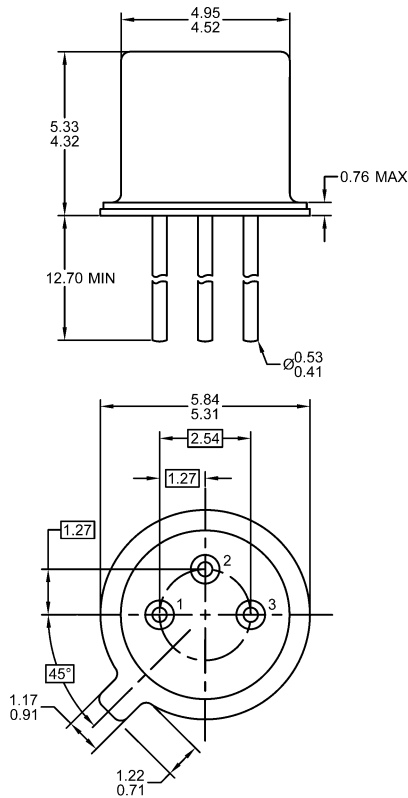

1. All linear dimensions are in millimeters.
2. Package weight approximately 0.29 grams
3. Bulk product is shipped in standard ESD shipping material
4. Refer to JEDEC standards for additional information.

Suggested Through-Hole Layout

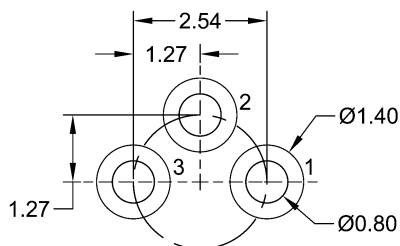

1. All linear dimensions are in millimeters.
2. The suggested land pattern dimensions have been provided as a straight lead reference only. A more robust pattern may be desired for wave soldering and/or bent lead configurations.