

U311 N-Channel JFET

Features

- InterFET [N0072L Geometry](#)
- Low Noise: 2 nV/VHz Typical
- Low Ciss: 4pF Typical
- RoHS Compliant
- SMT, TH, and Bare Die Package options.

Applications

- Mixers
- Oscillators
- VHF/UHF Amplifiers

Description

The -25V InterFET U311 JFET is targeted for higher gain VHF amplifiers, mixers, and oscillators. Gate leakages are typically less than 10pA at room temperatures.

TO-72 Bottom View

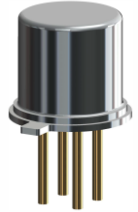
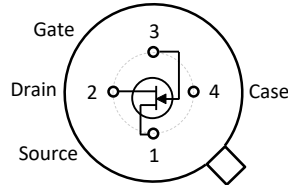

SOT23 Top View

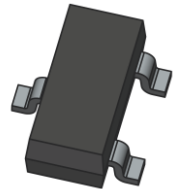
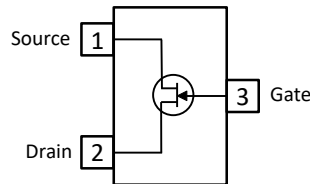

TO-92 Bottom View

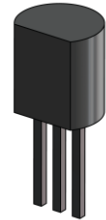
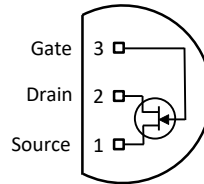

Product Summary

Parameters	U311 Min	Unit
BV _{GSS} Gate to Source Breakdown Voltage	-25	V
I _{DSS} Drain to Source Saturation Current	20	mA
V _{GS(off)} Gate to Source Cutoff Voltage	-1	V
G _{FS} Forward Transconductance	10	mS

Ordering Information Custom Part and Binning Options Available

Part Number	Description	Case	Packaging
U311	Through-Hole	TO-72	Bulk
PNU311	Through-Hole	TO-92	Bulk
SMPU311	Surface Mount	SOT23	Bulk
SMPU311TR	7" Tape and Reel: Max 3,000 Pieces 13" Tape and Reel: Max 9,000 Pieces	SOT23	Minimum 1,000 Pieces Tape and Reel
U311COT	Chip Orientated Tray (COT Waffle Pack)	COT	400/Waffle Pack
U311CFT	Chip Face-up Tray (CFT Waffle Pack)	CFT	400/Waffle Pack



Disclaimer: It is the Buyers responsibility for designing, validating and testing the end application under all field use cases and extreme use conditions. Guaranteeing the application meets required standards, regulatory compliance, and all safety and security requirements is the responsibility of the Buyer. These resources are subject to change without notice.

Electrical Characteristics

Maximum Ratings (@ $T_A = 25^\circ\text{C}$, Unless otherwise specified)

Parameters	Value	Unit
V_{RGS} Reverse Gate Source and Gate Drain Voltage	-25	V
I_{FG} Continuous Forward Gate Current	10	mA
P_D Continuous Device Power Dissipation	300	mW
P Power Derating	2.4	mW/ $^\circ\text{C}$
T_J Operating Junction Temperature	-55 to 125	$^\circ\text{C}$
T_{STG} Storage Temperature	-65 to 200	$^\circ\text{C}$

Static Characteristics (@ $T_A = 25^\circ\text{C}$, Unless otherwise specified)

Parameters	Conditions	U311			Unit
		Min	Typ	Max	
$V_{(BR)GSS}$ Gate to Source Breakdown Voltage	$V_{DS} = 0V, I_G = -1\mu\text{A}$	-25			V
I_{GSS} Gate to Source Reverse Current	$V_{GS} = -15V, V_{DS} = 0V, T_A = 25^\circ\text{C}$ $V_{GS} = -15V, V_{DS} = 0V, T_A = 150^\circ\text{C}$			-150 -150	pA nA
$V_{GS(OFF)}$ Gate to Source Cutoff Voltage	$V_{DS} = 10V, I_D = 1\text{nA}$	-1		-6	V
$V_{GS(F)}$ Gate to Source Forward Voltage	$V_{DS} = 0V, I_G = 1\text{mA}$			1	V
I_{DSS} Drain to Source Saturation Current	$V_{GS} = 0V, V_{DS} = 10V$ (Pulsed)	20		60	mA

Dynamic Characteristics (@ $T_A = 25^\circ\text{C}$, Unless otherwise specified)

Parameters	Conditions	U311			Unit
		Min	Typ	Max	
G_{FS} Forward Transconductance	$V_{DS} = 10V, I_D = 10\text{mA}, f = 1\text{kHz}$	10	17		mS
G_{OS} Output Conductance	$V_{DS} = 10V, I_D = 10\text{mA}, f = 1\text{kHz}$			250	μS
C_{dg} Drain Gate Capacitance	$V_{DS} = 10V, I_D = 10\text{mA}, f = 1\text{MHz}$			2.5	pF
C_{gs} Source Gate Capacitance	$V_{DS} = 10V, I_D = 10\text{mA}, f = 1\text{MHz}$			5	pF

SOT23 (TO-236AB) Mechanical and Layout Data

Package Outline Data



1. All linear dimensions are in millimeters.
2. Package weight approximately 0.12 grams
3. Molded plastic case UL 94V-0 rated
4. For Tape and Reel specifications refer to InterFET CTC-021 Tape and Reel Specification, Document number: IF39002
5. Bulk product is shipped in standard ESD shipping material
6. Refer to JEDEC standards for additional information.

Suggested Pad Layout



1. All linear dimensions are in millimeters.
2. The suggested land pattern dimensions have been provided for reference only. A more robust pattern may be desired for wave soldering.

TO-72 Mechanical and Layout Data

Package Outline Data

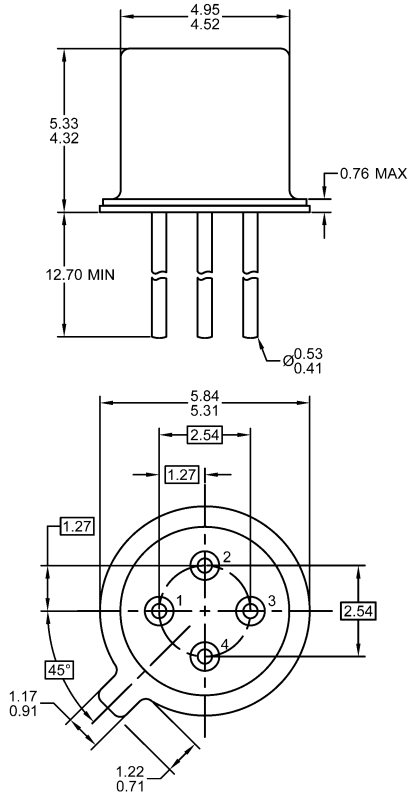

1. All linear dimensions are in millimeters.
2. Four lead device. Not all leads are shown in drawing views.
3. Package weight approximately 0.31 grams
4. Bulk product is shipped in standard ESD shipping material
5. Refer to JEDEC standards for additional information.

Suggested Through-Hole Layout

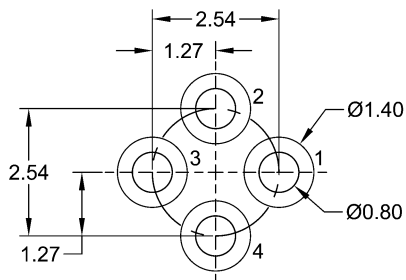

1. All linear dimensions are in millimeters.
2. The suggested land pattern dimensions have been provided as a straight lead reference only. A more robust pattern may be desired for wave soldering and/or bent lead configurations.