

MUN2240, MMUN2240L, MUN5240, DTC144TE, DTC144TM3, NSBC144TF3

Digital Transistors (BRT) R1 = 47 kΩ, R2 = ∞ kΩ

NPN Transistors with Monolithic Bias Resistor Network

This series of digital transistors is designed to replace a single device and its external resistor bias network. The Bias Resistor Transistor (BRT) contains a single transistor with a monolithic bias network consisting of two resistors; a series base resistor and a base-emitter resistor. The BRT eliminates these individual components by integrating them into a single device. The use of a BRT can reduce both system cost and board space.

Features

- Simplifies Circuit Design
- Reduces Board Space
- Reduces Component Count
- S and NSV Prefix for Automotive and Other Applications Requiring Unique Site and Control Change Requirements; AEC-Q101 Qualified and PPAP Capable
- These Devices are Pb-Free, Halogen Free/BFR Free and are RoHS Compliant

MAXIMUM RATINGS (T_A = 25°C)

Rating	Symbol	Max	Unit
Collector-Base Voltage	V _{CBO}	50	Vdc
Collector-Emitter Voltage	V _{CEO}	50	Vdc
Collector Current – Continuous	I _C	100	mAdc
Input Forward Voltage	V _{IN(fwd)}	40	Vdc
Input Reverse Voltage	V _{IN(rev)}	6	Vdc

Stresses exceeding those listed in the Maximum Ratings table may damage the device. If any of these limits are exceeded, device functionality should not be assumed, damage may occur and reliability may be affected.



ON Semiconductor®

www.onsemi.com

PIN CONNECTIONS

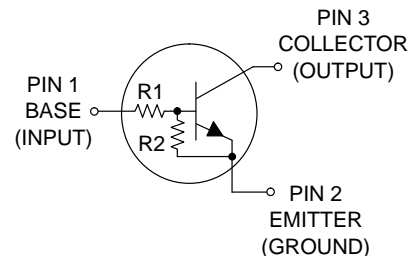

MARKING DIAGRAMS

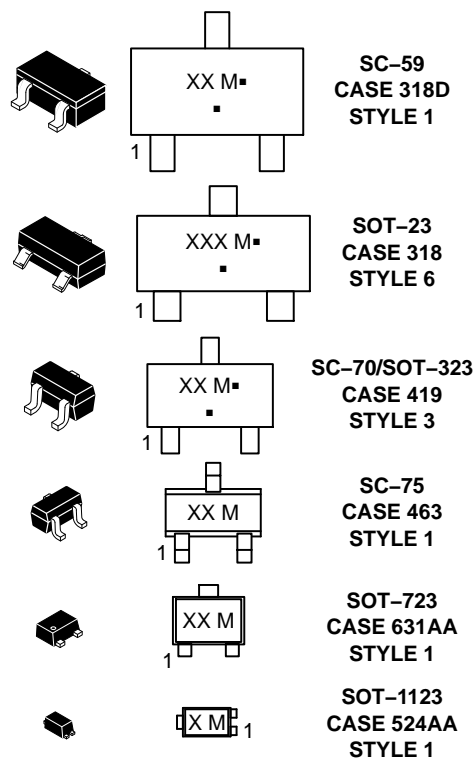

XXX = Specific Device Code
M = Date Code*
▪ = Pb-Free Package

(Note: Microdot may be in either location)

*Date Code orientation may vary depending upon manufacturing location.

ORDERING INFORMATION

See detailed ordering, marking, and shipping information in the package dimensions section on page 2 of this data sheet.

MUN2240, MMUN2240L, MUN5240, DTC144TE, DTC144TM3, NSBC144TF3

Table 1. ORDERING INFORMATION

Device	Part Marking	Package	Shipping†
MUN2240T1G, SMUN2240T1G	8T	SC-59 (Pb-Free)	3000 / Tape & Reel
MMUN2240LT1G	AA4	SOT-23 (Pb-Free)	3000 / Tape & Reel
MUN5240T1G	AR	SC-70/SOT-323 (Pb-Free)	3000 / Tape & Reel
DTC144TET1G	7T	SC-75 (Pb-Free)	3000 / Tape & Reel
DTC144TM3T5G, NSVDTC144TM3T5G	8T	SOT-723 (Pb-Free)	8000 / Tape & Reel
NSBC144TF3T5G	K (180°)	SOT-1123 (Pb-Free)	8000 / Tape & Reel

†For information on tape and reel specifications, including part orientation and tape sizes, please refer to our Tape and Reel Packaging Specifications Brochure, BRD8011/D.

* (xx°) = Degree rotation in the clockwise direction.



- (1) SC-75 and SC-70/SOT323; Minimum Pad
- (2) SC-59; Minimum Pad
- (3) SOT-23; Minimum Pad
- (4) SOT-1123; 100 mm², 1 oz. copper trace
- (5) SOT-723; Minimum Pad

Figure 1. Derating Curve

MUN2240, MMUN2240L, MUN5240, DTC144TE, DTC144TM3, NSBC144TF3

Table 2. THERMAL CHARACTERISTICS

Characteristic	Symbol	Max	Unit
THERMAL CHARACTERISTICS (SC-59) (MUN2240)			
Total Device Dissipation $T_A = 25^\circ\text{C}$ Derate above 25°C	(Note 1) (Note 2) (Note 1) (Note 2)	P_D 230 338 1.8 2.7	mW mW/ $^\circ\text{C}$
Thermal Resistance, Junction to Ambient	(Note 1) (Note 2)	$R_{\theta JA}$ 540 370	$^\circ\text{C/W}$
Thermal Resistance, Junction to Lead	(Note 1) (Note 2)	$R_{\theta JL}$ 264 287	$^\circ\text{C/W}$
Junction and Storage Temperature Range	T_J, T_{stg}	-55 to +150	$^\circ\text{C}$
THERMAL CHARACTERISTICS (SOT-23) (MMUN2240L)			
Total Device Dissipation $T_A = 25^\circ\text{C}$ Derate above 25°C	(Note 1) (Note 2) (Note 1) (Note 2)	P_D 246 400 2.0 3.2	mW mW/ $^\circ\text{C}$
Thermal Resistance, Junction to Ambient	(Note 1) (Note 2)	$R_{\theta JA}$ 508 311	$^\circ\text{C/W}$
Thermal Resistance, Junction to Lead	(Note 1) (Note 2)	$R_{\theta JL}$ 174 208	$^\circ\text{C/W}$
Junction and Storage Temperature Range	T_J, T_{stg}	-55 to +150	$^\circ\text{C}$
THERMAL CHARACTERISTICS (SC-70/SOT-323) (MUN5240)			
Total Device Dissipation $T_A = 25^\circ\text{C}$ Derate above 25°C	(Note 1) (Note 2) (Note 1) (Note 2)	P_D 202 310 1.6 2.5	mW mW/ $^\circ\text{C}$
Thermal Resistance, Junction to Ambient	(Note 1) (Note 2)	$R_{\theta JA}$ 618 403	$^\circ\text{C/W}$
Thermal Resistance, Junction to Lead	(Note 1) (Note 2)	$R_{\theta JL}$ 280 332	$^\circ\text{C/W}$
Junction and Storage Temperature Range	T_J, T_{stg}	-55 to +150	$^\circ\text{C}$
THERMAL CHARACTERISTICS (SC-75) (DTC144TE)			
Total Device Dissipation $T_A = 25^\circ\text{C}$ Derate above 25°C	(Note 1) (Note 2) (Note 1) (Note 2)	P_D 200 300 1.6 2.4	mW mW/ $^\circ\text{C}$
Thermal Resistance, Junction to Ambient	(Note 1) (Note 2)	$R_{\theta JA}$ 600 400	$^\circ\text{C/W}$
Junction and Storage Temperature Range	T_J, T_{stg}	-55 to +150	$^\circ\text{C}$
THERMAL CHARACTERISTICS (SOT-723) (DTC144TM3)			
Total Device Dissipation $T_A = 25^\circ\text{C}$ Derate above 25°C	(Note 1) (Note 2) (Note 1) (Note 2)	P_D 260 600 2.0 4.8	mW mW/ $^\circ\text{C}$
Thermal Resistance, Junction to Ambient	(Note 1) (Note 2)	$R_{\theta JA}$ 480 205	$^\circ\text{C/W}$
Junction and Storage Temperature Range	T_J, T_{stg}	-55 to +150	$^\circ\text{C}$

- FR-4 @ Minimum Pad.
- FR-4 @ 1.0 x 1.0 Inch Pad.
- FR-4 @ 100 mm², 1 oz. copper traces, still air.
- FR-4 @ 500 mm², 1 oz. copper traces, still air.

MUN2240, MMUN2240L, MUN5240, DTC144TE, DTC144TM3, NSBC144TF3

Table 2. THERMAL CHARACTERISTICS

Characteristic	Symbol	Max	Unit
THERMAL CHARACTERISTICS (SOT-1123) (NSBC144TF3)			
Total Device Dissipation $T_A = 25^\circ\text{C}$	P_D	254 297	mW
Derate above 25°C		2.0 2.4	mW/ $^\circ\text{C}$
Thermal Resistance, Junction to Ambient	$R_{\theta JA}$	493 421	$^\circ\text{C}/\text{W}$
Thermal Resistance, Junction to Lead	$R_{\theta JL}$	193	$^\circ\text{C}/\text{W}$
Junction and Storage Temperature Range	T_J, T_{stg}	-55 to +150	$^\circ\text{C}$

- FR-4 @ Minimum Pad.
- FR-4 @ 1.0 x 1.0 Inch Pad.
- FR-4 @ 100 mm², 1 oz. copper traces, still air.
- FR-4 @ 500 mm², 1 oz. copper traces, still air.

Table 3. ELECTRICAL CHARACTERISTICS ($T_A = 25^\circ\text{C}$, unless otherwise noted)

Characteristic	Symbol	Min	Typ	Max	Unit
OFF CHARACTERISTICS					
Collector-Base Cutoff Current ($V_{CB} = 50\text{ V}, I_E = 0$)	I_{CBO}	-	-	100	nAdc
Collector-Emitter Cutoff Current ($V_{CE} = 50\text{ V}, I_B = 0$)	I_{CEO}	-	-	500	nAdc
Emitter-Base Cutoff Current ($V_{EB} = 6.0\text{ V}, I_C = 0$)	I_{EBO}	-	-	0.2	mAdc
Collector-Base Breakdown Voltage ($I_C = 10\ \mu\text{A}, I_E = 0$)	$V_{(BR)CBO}$	50	-	-	Vdc
Collector-Emitter Breakdown Voltage (Note 5) ($I_C = 2.0\text{ mA}, I_B = 0$)	$V_{(BR)CEO}$	50	-	-	Vdc
ON CHARACTERISTICS					
DC Current Gain (Note 5) ($I_C = 5.0\text{ mA}, V_{CE} = 10\text{ V}$)	h_{FE}	120	300	-	
Collector-Emitter Saturation Voltage (Note 5) ($I_C = 10\text{ mA}, I_B = 1.0\text{ mA}$)	$V_{CE(sat)}$	-	-	0.25	Vdc
Input Voltage (off) ($V_{CE} = 5.0\text{ V}, I_C = 100\ \mu\text{A}$)	$V_{i(off)}$	-	0.6	0.5	Vdc
Input Voltage (on) ($V_{CE} = 0.3\text{ V}, I_C = 10\text{ mA}$)	$V_{i(on)}$	4.0	2.6	-	Vdc
Output Voltage (on) ($V_{CC} = 5.0\text{ V}, V_B = 3.5\text{ V}, R_L = 1.0\text{ k}\Omega$)	V_{OL}	-	-	0.2	Vdc
Output Voltage (off) ($V_{CC} = 5.0\text{ V}, V_B = 0.25\text{ V}, R_L = 1.0\text{ k}\Omega$)	V_{OH}	4.9	-	-	Vdc
Input Resistor	R1	32.9	47	61.1	k Ω

Product parametric performance is indicated in the Electrical Characteristics for the listed test conditions, unless otherwise noted. Product performance may not be indicated by the Electrical Characteristics if operated under different conditions.

- Pulsed Condition: Pulse Width = 300 msec, Duty Cycle \leq 2%.

TYPICAL CHARACTERISTICS – MUN2240, MMUN2240L, MUN5240, DTC144TE, DTC144TM3

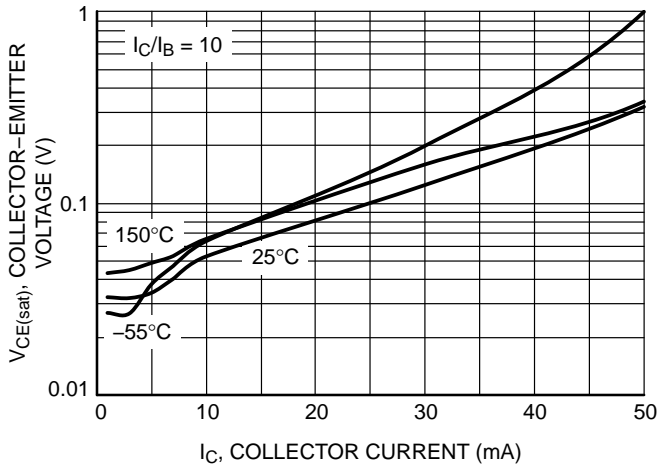

Figure 2. $V_{CE(sat)}$ vs. I_C

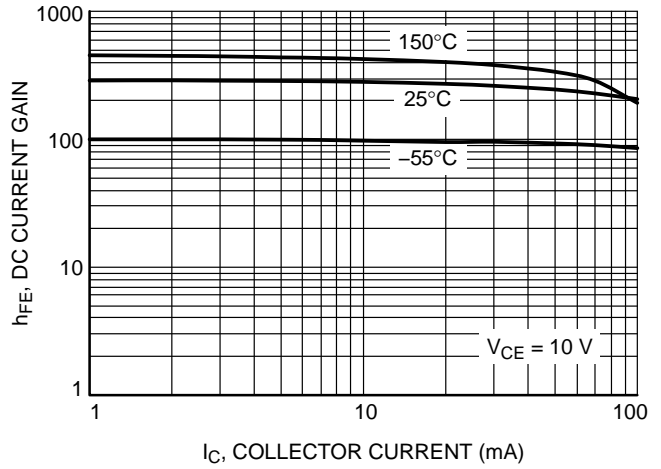

Figure 3. DC Current Gain

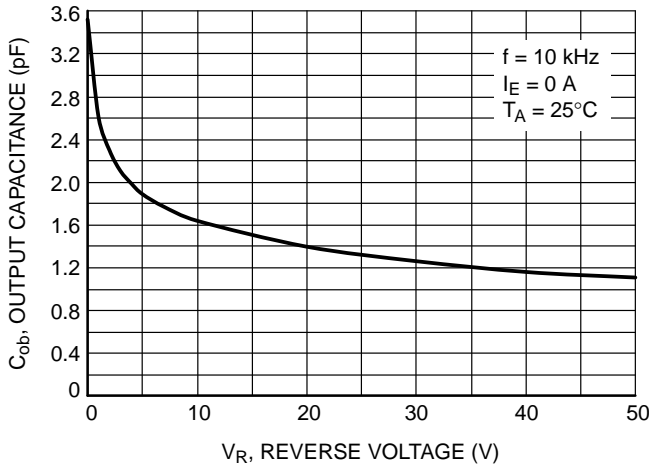

Figure 4. Output Capacitance

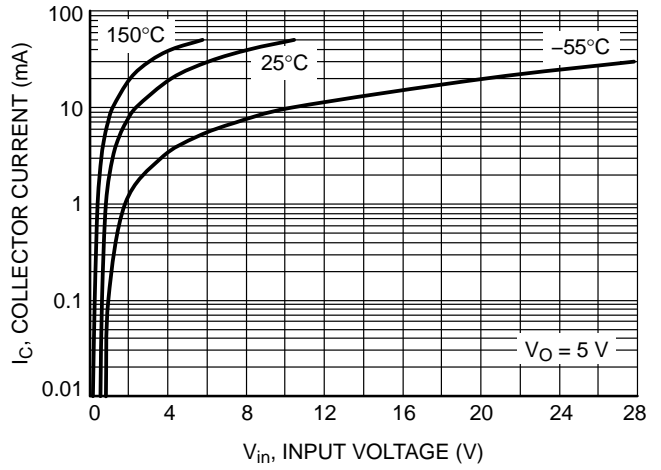

Figure 5. Output Current vs. Input Voltage

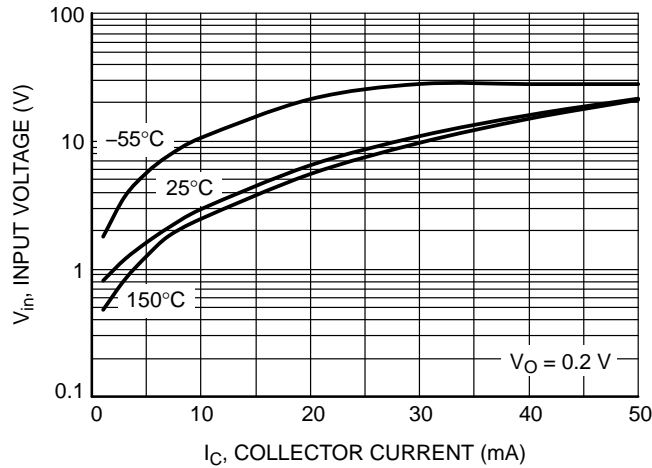

Figure 6. Input Voltage vs. Output Current

MECHANICAL CASE OUTLINE PACKAGE DIMENSIONS



SOT-23 (TO-236)
CASE 318
ISSUE AT

DATE 01 MAR 2023

SCALE 4:1



NOTES:

1. DIMENSIONING AND TOLERANCING PER ASME Y14.5M,1994.
2. CONTROLLING DIMENSION: MILLIMETERS
3. MAXIMUM LEAD THICKNESS INCLUDES LEAD FINISH. MINIMUM LEAD THICKNESS IS THE MINIMUM THICKNESS OF THE BASE MATERIAL.
4. DIMENSIONS D AND E DO NOT INCLUDE MOLD FLASH, PROTRUSIONS, OR GATE BURRS.

DIM	MILLIMETERS			INCHES		
	MIN.	NOM.	MAX.	MIN.	NOM.	MAX.
A	0.89	1.00	1.11	0.035	0.039	0.044
A1	0.01	0.06	0.10	0.000	0.002	0.004
b	0.37	0.44	0.50	0.015	0.017	0.020
c	0.08	0.14	0.20	0.003	0.006	0.008
D	2.80	2.90	3.04	0.110	0.114	0.120
E	1.20	1.30	1.40	0.047	0.051	0.055
e	1.78	1.90	2.04	0.070	0.075	0.080
L	0.30	0.43	0.55	0.012	0.017	0.022
L1	0.35	0.54	0.69	0.014	0.021	0.027
H _E	2.10	2.40	2.64	0.083	0.094	0.104
T	0°	---	10°	0°	---	10°

GENERIC MARKING DIAGRAM*



- XXX = Specific Device Code
- M = Date Code
- = Pb-Free Package

*This information is generic. Please refer to device data sheet for actual part marking. Pb-Free indicator, "G" or microdot "▪", may or may not be present. Some products may not follow the Generic Marking.



RECOMMENDED MOUNTING FOOTPRINT

* For additional information on our Pb-Free strategy and soldering details, please download the ON Semiconductor Soldering and Mounting Techniques Reference Manual, SOLDERRM/D.

STYLES ON PAGE 2

DOCUMENT NUMBER:	98ASB42226B	Electronic versions are uncontrolled except when accessed directly from the Document Repository. Printed versions are uncontrolled except when stamped "CONTROLLED COPY" in red.
DESCRIPTION:	SOT-23 (TO-236)	PAGE 1 OF 2

onsemi and ONSEMI are trademarks of Semiconductor Components Industries, LLC dba onsemi or its subsidiaries in the United States and/or other countries. onsemi reserves the right to make changes without further notice to any products herein. onsemi makes no warranty, representation or guarantee regarding the suitability of its products for any particular purpose, nor does onsemi assume any liability arising out of the application or use of any product or circuit, and specifically disclaims any and all liability, including without limitation special, consequential or incidental damages. onsemi does not convey any license under its patent rights nor the rights of others.

MECHANICAL CASE OUTLINE
PACKAGE DIMENSIONS



SOT-23 (TO-236)
CASE 318
ISSUE AT

DATE 01 MAR 2023

- | | | | | | |
|---|---|---|---|---|---|
| STYLE 1 THRU 5:
CANCELLED | STYLE 6:
PIN 1. BASE
2. EMITTER
3. COLLECTOR | STYLE 7:
PIN 1. EMITTER
2. BASE
3. COLLECTOR | STYLE 8:
PIN 1. ANODE
2. NO CONNECTION
3. CATHODE | | |
| STYLE 9:
PIN 1. ANODE
2. ANODE
3. CATHODE | STYLE 10:
PIN 1. DRAIN
2. SOURCE
3. GATE | STYLE 11:
PIN 1. ANODE
2. CATHODE
3. CATHODE-ANODE | STYLE 12:
PIN 1. CATHODE
2. CATHODE
3. ANODE | STYLE 13:
PIN 1. SOURCE
2. DRAIN
3. GATE | STYLE 14:
PIN 1. CATHODE
2. GATE
3. ANODE |
| STYLE 15:
PIN 1. GATE
2. CATHODE
3. ANODE | STYLE 16:
PIN 1. ANODE
2. CATHODE
3. CATHODE | STYLE 17:
PIN 1. NO CONNECTION
2. ANODE
3. CATHODE | STYLE 18:
PIN 1. NO CONNECTION
2. CATHODE
3. ANODE | STYLE 19:
PIN 1. CATHODE
2. ANODE
3. CATHODE-ANODE | STYLE 20:
PIN 1. CATHODE
2. ANODE
3. GATE |
| STYLE 21:
PIN 1. GATE
2. SOURCE
3. DRAIN | STYLE 22:
PIN 1. RETURN
2. OUTPUT
3. INPUT | STYLE 23:
PIN 1. ANODE
2. ANODE
3. CATHODE | STYLE 24:
PIN 1. GATE
2. DRAIN
3. SOURCE | STYLE 25:
PIN 1. ANODE
2. CATHODE
3. GATE | STYLE 26:
PIN 1. CATHODE
2. ANODE
3. NO CONNECTION |
| STYLE 27:
PIN 1. CATHODE
2. CATHODE
3. CATHODE | STYLE 28:
PIN 1. ANODE
2. ANODE
3. ANODE | | | | |

DOCUMENT NUMBER:	98ASB42226B	Electronic versions are uncontrolled except when accessed directly from the Document Repository. Printed versions are uncontrolled except when stamped "CONTROLLED COPY" in red.
DESCRIPTION:	SOT-23 (TO-236)	PAGE 2 OF 2

onsemi and **ONSEMI** are trademarks of Semiconductor Components Industries, LLC dba **onsemi** or its subsidiaries in the United States and/or other countries. **onsemi** reserves the right to make changes without further notice to any products herein. **onsemi** makes no warranty, representation or guarantee regarding the suitability of its products for any particular purpose, nor does **onsemi** assume any liability arising out of the application or use of any product or circuit, and specifically disclaims any and all liability, including without limitation special, consequential or incidental damages. **onsemi** does not convey any license under its patent rights nor the rights of others.

MECHANICAL CASE OUTLINE PACKAGE DIMENSIONS



SCALE 2:1

SC-59
CASE 318D-04
ISSUE H

DATE 28 JUN 2012

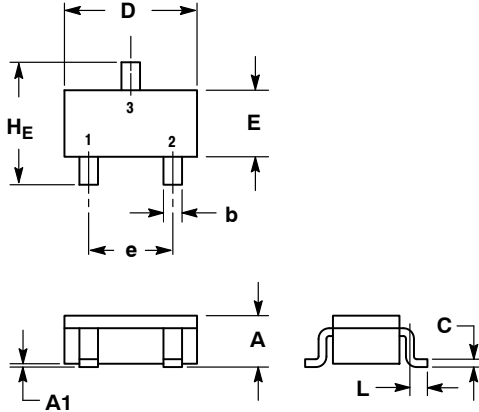

GENERIC MARKING DIAGRAM*

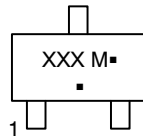

- XXX = Specific Device Code
- M = Date Code
- = Pb-Free Package*

(*Note: Microdot may be in either location)

*This information is generic. Please refer to device data sheet for actual part marking. Pb-Free indicator, "G" or microdot "•", may or may not be present. Some products may not follow the Generic Marking.

- NOTES:
1. DIMENSIONING AND TOLERANCING PER ANSI Y14.5M, 1982.
2. CONTROLLING DIMENSION: MILLIMETER.

DIM	MILLIMETERS			INCHES		
	MIN	NOM	MAX	MIN	NOM	MAX
A	1.00	1.15	1.30	0.039	0.045	0.051
A1	0.01	0.06	0.10	0.001	0.002	0.004
b	0.35	0.43	0.50	0.014	0.017	0.020
c	0.09	0.14	0.18	0.003	0.005	0.007
D	2.70	2.90	3.10	0.106	0.114	0.122
E	1.30	1.50	1.70	0.051	0.059	0.067
e	1.70	1.90	2.10	0.067	0.075	0.083
L	0.20	0.40	0.60	0.008	0.016	0.024
HE	2.50	2.80	3.00	0.099	0.110	0.118

RECOMMENDED SOLDERING FOOTPRINT*

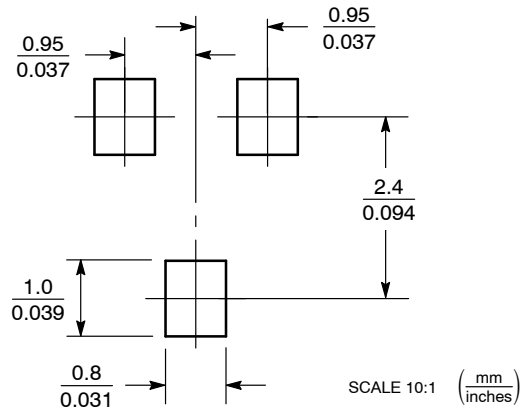

*For additional information on our Pb-Free strategy and soldering details, please download the **onsemi** Soldering and Mounting Techniques Reference Manual, SOLDERRM/D.

- | | | |
|---|--|--|
| <p>STYLE 1:
PIN 1. BASE
2. EMITTER
3. COLLECTOR</p> | <p>STYLE 2:
PIN 1. ANODE
2. N.C.
3. CATHODE</p> | <p>STYLE 3:
PIN 1. ANODE
2. ANODE
3. CATHODE</p> |
| <p>STYLE 4:
PIN 1. CATHODE
2. N.C.
3. ANODE</p> | <p>STYLE 5:
PIN 1. CATHODE
2. CATHODE
3. ANODE</p> | <p>STYLE 6:
PIN 1. ANODE
2. CATHODE
3. ANODE/CATHODE</p> |

DOCUMENT NUMBER:	98ASB42664B	Electronic versions are uncontrolled except when accessed directly from the Document Repository. Printed versions are uncontrolled except when stamped "CONTROLLED COPY" in red.
DESCRIPTION:	SC-59	PAGE 1 OF 1

onsemi and ONSEMI are trademarks of Semiconductor Components Industries, LLC dba onsemi or its subsidiaries in the United States and/or other countries. onsemi reserves the right to make changes without further notice to any products herein. onsemi makes no warranty, representation or guarantee regarding the suitability of its products for any particular purpose, nor does onsemi assume any liability arising out of the application or use of any product or circuit, and specifically disclaims any and all liability, including without limitation special, consequential or incidental damages. onsemi does not convey any license under its patent rights nor the rights of others.

MECHANICAL CASE OUTLINE PACKAGE DIMENSIONS



SCALE 4:1

SC-70 (SOT-323) CASE 419 ISSUE R

DATE 11 OCT 2022



NOTES:

1. DIMENSIONING AND TOLERANCING PER ASME Y14.5M, 1982.
2. CONTROLLING DIMENSION: INCH

DIM	MILLIMETERS			INCHES		
	MIN.	NOM.	MAX.	MIN.	NOM.	MAX.
A	0.80	0.90	1.00	0.032	0.035	0.040
A1	0.00	0.05	0.10	0.000	0.002	0.004
A2	0.70 REF			0.028 BSC		
b	0.30	0.35	0.40	0.012	0.014	0.016
c	0.10	0.18	0.25	0.004	0.007	0.010
D	1.80	2.00	2.20	0.071	0.080	0.087
E	1.15	1.24	1.35	0.045	0.049	0.053
e	1.20	1.30	1.40	0.047	0.051	0.055
e1	0.65 BSC			0.026 BSC		
L	0.20	0.38	0.56	0.008	0.015	0.022
H _E	2.00	2.10	2.40	0.079	0.083	0.095

GENERIC MARKING DIAGRAM



- XX = Specific Device Code
- M = Date Code
- = Pb-Free Package

*This information is generic. Please refer to device data sheet for actual part marking. Pb-Free indicator, "G" or microdot "▪", may or may not be present. Some products may not follow the Generic Marking.



* For additional information on our Pb-Free strategy and soldering details, please download the DN Semiconductor Soldering and Mounting Techniques Reference Manual, SOLDERM/D.

SOLDERING FOOTPRINT

- | | | | | | |
|---|---|---|--|---|---|
| STYLE 1:
CANCELLED | STYLE 2:
PIN 1. ANODE
2. N.C.
3. CATHODE | STYLE 3:
PIN 1. BASE
2. EMITTER
3. COLLECTOR | STYLE 4:
PIN 1. CATHODE
2. CATHODE
3. ANODE | STYLE 5:
PIN 1. ANODE
2. ANODE
3. CATHODE | |
| STYLE 6:
PIN 1. EMITTER
2. BASE
3. COLLECTOR | STYLE 7:
PIN 1. BASE
2. EMITTER
3. COLLECTOR | STYLE 8:
PIN 1. GATE
2. SOURCE
3. DRAIN | STYLE 9:
PIN 1. ANODE
2. CATHODE
3. CATHODE-ANODE | STYLE 10:
PIN 1. CATHODE
2. ANODE
3. ANODE-CATHODE | STYLE 11:
PIN 1. CATHODE
2. CATHODE
3. CATHODE |

DOCUMENT NUMBER:	98ASB42819B	Electronic versions are uncontrolled except when accessed directly from the Document Repository. Printed versions are uncontrolled except when stamped "CONTROLLED COPY" in red.
DESCRIPTION:	SC-70 (SOT-323)	PAGE 1 OF 1

onsemi and ONSEMI are trademarks of Semiconductor Components Industries, LLC dba onsemi or its subsidiaries in the United States and/or other countries. onsemi reserves the right to make changes without further notice to any products herein. onsemi makes no warranty, representation or guarantee regarding the suitability of its products for any particular purpose, nor does onsemi assume any liability arising out of the application or use of any product or circuit, and specifically disclaims any and all liability, including without limitation special, consequential or incidental damages. onsemi does not convey any license under its patent rights nor the rights of others.

MECHANICAL CASE OUTLINE PACKAGE DIMENSIONS

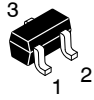

SCALE 4:1

SC-75/SOT-416
CASE 463
ISSUE G

DATE 07 AUG 2015

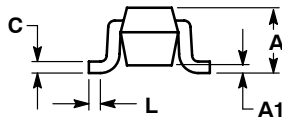
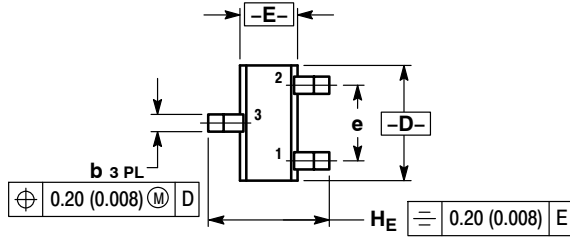

STYLE 1:
PIN 1. BASE
2. EMITTER
3. COLLECTOR

STYLE 2:
PIN 1. ANODE
2. N/C
3. CATHODE

STYLE 3:
PIN 1. ANODE
2. ANODE
3. CATHODE

STYLE 4:
PIN 1. CATHODE
2. CATHODE
3. ANODE

STYLE 5:
PIN 1. GATE
2. SOURCE
3. DRAIN

GENERIC MARKING DIAGRAM*

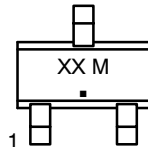

XX = Specific Device Code
M = Date Code
▪ = Pb-Free Package

*This information is generic. Please refer to device data sheet for actual part marking. Pb-Free indicator, "G" or microdot "▪", may or may not be present. Some products may not follow the Generic Marking.

NOTES:

- DIMENSIONING AND TOLERANCING PER ANSI Y14.5M, 1982.
- CONTROLLING DIMENSION: MILLIMETER.

DIM	MILLIMETERS			INCHES		
	MIN	NOM	MAX	MIN	NOM	MAX
A	0.70	0.80	0.90	0.027	0.031	0.035
A1	0.00	0.05	0.10	0.000	0.002	0.004
b	0.15	0.20	0.30	0.006	0.008	0.012
C	0.10	0.15	0.25	0.004	0.006	0.010
D	1.55	1.60	1.65	0.061	0.063	0.065
E	0.70	0.80	0.90	0.027	0.031	0.035
e	1.00 BSC			0.04 BSC		
L	0.10	0.15	0.20	0.004	0.006	0.008
H _E	1.50	1.60	1.70	0.060	0.063	0.067

RECOMMENDED SOLDERING FOOTPRINT*

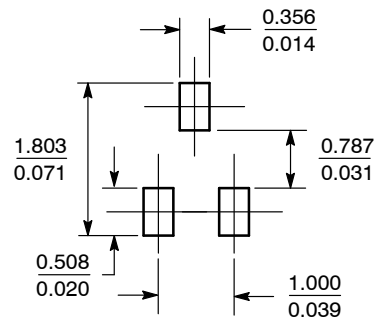

SCALE 10:1 (mm/inches)

*For additional information on our Pb-Free strategy and soldering details, please download the onsemi Soldering and Mounting Techniques Reference Manual, SOLDERRM/D.

DOCUMENT NUMBER:	98ASB15184C	Electronic versions are uncontrolled except when accessed directly from the Document Repository. Printed versions are uncontrolled except when stamped "CONTROLLED COPY" in red.
DESCRIPTION:	SC-75/SOT-416	PAGE 1 OF 1

onsemi and ONSEMI are trademarks of Semiconductor Components Industries, LLC dba onsemi or its subsidiaries in the United States and/or other countries. onsemi reserves the right to make changes without further notice to any products herein. onsemi makes no warranty, representation or guarantee regarding the suitability of its products for any particular purpose, nor does onsemi assume any liability arising out of the application or use of any product or circuit, and specifically disclaims any and all liability, including without limitation special, consequential or incidental damages. onsemi does not convey any license under its patent rights nor the rights of others.

MECHANICAL CASE OUTLINE

PACKAGE DIMENSIONS



SCALE 8:1

SOT-1123
CASE 524AA
ISSUE C

DATE 29 NOV 2011

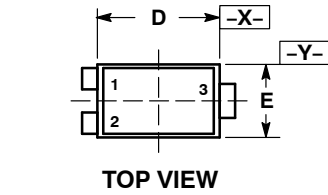

TOP VIEW

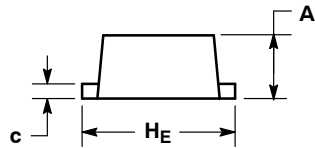

SIDE VIEW

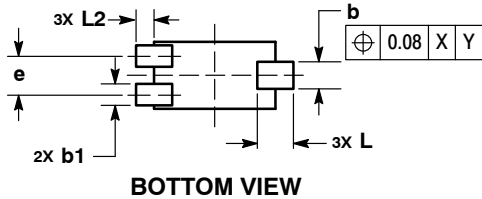

BOTTOM VIEW

NOTES:

1. DIMENSIONING AND TOLERANCING PER ASME Y14.5M, 1994.
2. CONTROLLING DIMENSION: MILLIMETERS.
3. MAXIMUM LEAD THICKNESS INCLUDES LEAD FINISH. MINIMUM LEAD THICKNESS IS THE MINIMUM THICKNESS OF BASE MATERIAL.
4. DIMENSIONS D AND E DO NOT INCLUDE MOLD FLASH, PROTRUSIONS, OR GATE BURRS.

DIM	MILLIMETERS	
	MIN	MAX
A	0.34	0.40
b	0.15	0.28
b1	0.10	0.20
c	0.07	0.17
D	0.75	0.85
E	0.55	0.65
e	0.35	0.40
H _E	0.95	1.05
L	0.185	REF
L2	0.05	0.15

SOLDERING FOOTPRINT*

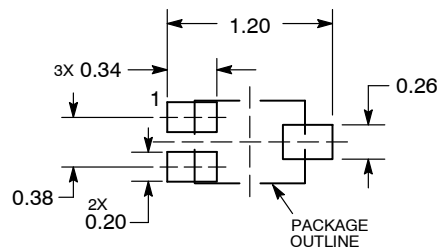

DIMENSIONS: MILLIMETERS

*For additional information on our Pb-Free strategy and soldering details, please download the **onsemi** Soldering and Mounting Techniques Reference Manual, SOLDERRM/D.

GENERIC MARKING DIAGRAM*

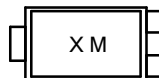

X = Specific Device Code
M = Date Code

*This information is generic. Please refer to device data sheet for actual part marking. Pb-Free indicator, "G" or microdot "•", may or may not be present. Some products may not follow the Generic Marking.

STYLE 1: PIN 1. BASE 2. EMITTER 3. COLLECTOR	STYLE 2: PIN 1. ANODE 2. N/C 3. CATHODE	STYLE 3: PIN 1. ANODE 2. ANODE 3. CATHODE	STYLE 4: PIN 1. CATHODE 2. CATHODE 3. ANODE	STYLE 5: PIN 1. GATE 2. SOURCE 3. DRAIN
---	--	--	--	--

DOCUMENT NUMBER:	98AON23134D	Electronic versions are uncontrolled except when accessed directly from the Document Repository. Printed versions are uncontrolled except when stamped "CONTROLLED COPY" in red.
DESCRIPTION:	SOT-1123, 3-LEAD, 1.0x0.6x0.37, 0.35P	PAGE 1 OF 1

onsemi and **ONSEMI** are trademarks of Semiconductor Components Industries, LLC dba **onsemi** or its subsidiaries in the United States and/or other countries. **onsemi** reserves the right to make changes without further notice to any products herein. **onsemi** makes no warranty, representation or guarantee regarding the suitability of its products for any particular purpose, nor does **onsemi** assume any liability arising out of the application or use of any product or circuit, and specifically disclaims any and all liability, including without limitation special, consequential or incidental damages. **onsemi** does not convey any license under its patent rights nor the rights of others.

MECHANICAL CASE OUTLINE PACKAGE DIMENSIONS



SCALE 4:1

SOT-723
CASE 631AA
ISSUE D

DATE 10 AUG 2009

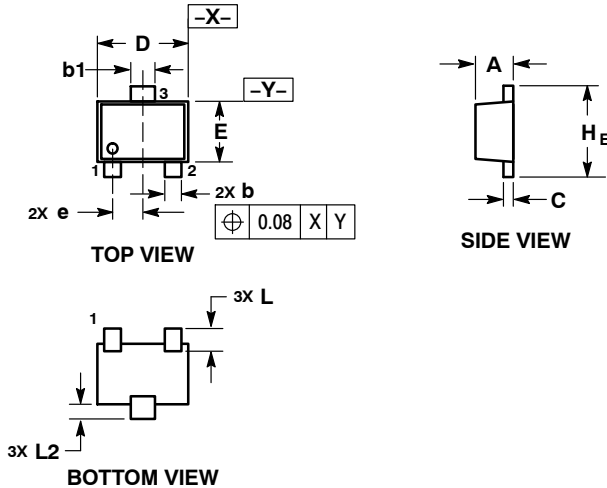

- NOTES:
1. DIMENSIONING AND TOLERANCING PER ASME Y14.5M, 1994.
 2. CONTROLLING DIMENSION: MILLIMETERS.
 3. MAXIMUM LEAD THICKNESS INCLUDES LEAD FINISH. MINIMUM LEAD THICKNESS IS THE MINIMUM THICKNESS OF BASE MATERIAL.
 4. DIMENSIONS D AND E DO NOT INCLUDE MOLD FLASH, PROTRUSIONS OR GATE BURRS.

DIM	MILLIMETERS		
	MIN	NOM	MAX
A	0.45	0.50	0.55
b	0.15	0.21	0.27
b1	0.25	0.31	0.37
C	0.07	0.12	0.17
D	1.15	1.20	1.25
E	0.75	0.80	0.85
e	0.40 BSC		
H E	1.15	1.20	1.25
L	0.29 REF		
L2	0.15	0.20	0.25

RECOMMENDED SOLDERING FOOTPRINT*

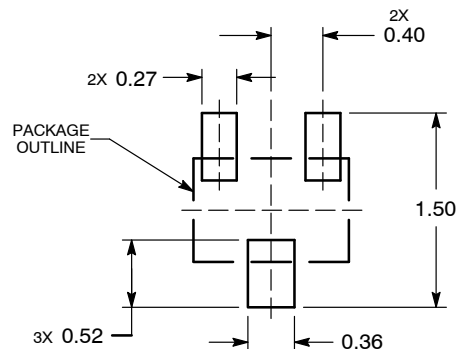

DIMENSIONS: MILLIMETERS

GENERIC MARKING DIAGRAM*

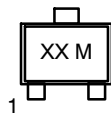

XX = Specific Device Code
M = Date Code

*This information is generic. Please refer to device data sheet for actual part marking. Pb-Free indicator, "G" or microdot "•", may or may not be present. Some products may not follow the Generic Marking.

*For additional information on our Pb-Free strategy and soldering details, please download the **onsemi** Soldering and Mounting Techniques Reference Manual, SOLDERRM/D.

- | | | | | |
|---|--|--|--|--|
| STYLE 1:
PIN 1. BASE
2. EMITTER
3. COLLECTOR | STYLE 2:
PIN 1. ANODE
2. N/C
3. CATHODE | STYLE 3:
PIN 1. ANODE
2. ANODE
3. CATHODE | STYLE 4:
PIN 1. CATHODE
2. CATHODE
3. ANODE | STYLE 5:
PIN 1. GATE
2. SOURCE
3. DRAIN |
|---|--|--|--|--|

DOCUMENT NUMBER:	98AON12989D	Electronic versions are uncontrolled except when accessed directly from the Document Repository. Printed versions are uncontrolled except when stamped "CONTROLLED COPY" in red.
DESCRIPTION:	SOT-723	PAGE 1 OF 1

onsemi and **ONSEMI** are trademarks of Semiconductor Components Industries, LLC dba **onsemi** or its subsidiaries in the United States and/or other countries. **onsemi** reserves the right to make changes without further notice to any products herein. **onsemi** makes no warranty, representation or guarantee regarding the suitability of its products for any particular purpose, nor does **onsemi** assume any liability arising out of the application or use of any product or circuit, and specifically disclaims any and all liability, including without limitation special, consequential or incidental damages. **onsemi** does not convey any license under its patent rights nor the rights of others.