

DATA SHEET

# SMV1405 to SMV1430 Series: Plastic-Packaged Abrupt Junction Tuning Varactors

## Applications

- High-Q resonators in wireless system VCOs
- High volume commercial systems

## Features

- High Q
- Low series resistance for low phase noise
- Packages rated MSL1, 260 °C per JEDEC J-STD-020



Skyworks Green™ products are compliant with all applicable legislation and are halogen-free. For additional information, refer to *Skyworks Definition of Green™*, document number SQ04-0074.



## Description

The SMV1405 to SMV1430 group of silicon abrupt junction varactor diodes is designed for use in Voltage Controlled Oscillators (VCOs) requiring tight capacitance tolerances. The low resistance of these varactors makes them appropriate for high-Q resonators in wireless system VCOs to frequencies above 10 GHz. This family of varactors is characterized for capacitance over temperature.

Table 1 describes the various packages and markings of the SMV1405 to SMV1430 group of varactors.

**Table 1. Packaging and Marking**

Single	Single	Common Cathode	Single
SC-79 Green™	SOT-23	SOT-23	SOD-882 Green™
<b>SMV1405-079LF</b> Marking: Cathode and A3			<b>SMV1405-040LF</b> Marking: 5
			<b>SMV1408-040LF</b> Marking: DV
<b>SMV1413-079LF</b> Marking: Cathode and A4	<b>SMV1413-001LF</b> Green™ Marking: ER1	<b>SMV1413-004LF</b> Green™ Marking: ER3	
			<b>SMV1430-040LF</b> Marking: 7
Ls = 0.7 nH	Ls = 1.5 nH	Ls = 1.5 nH	Ls = 0.45 nH



The Pb-free symbol or "LF" in the part number denotes a lead-free, RoHS-compliant package unless otherwise noted as Green™. Tin/lead (Sn/Pb) packaging is not recommended for new designs.

## Electrical and Mechanical Specifications

The absolute maximum ratings of the SMV1405 to SMV1430 varactors are provided in Table 2. Electrical specifications are provided in Table 3. Typical capacitance values are listed in Table 4. Typical performance characteristics of the SMV1405 to SMV1430 varactors are illustrated in Figures 1, 2, and 3.

The SPICE model for the SMV1405 to SMV1430 varactors is shown in Figure 4, and the associated model parameters are provided in Table 5.

## Package Dimensions

Package dimensions are shown in Figures 5 to 9 (odd numbers), and tape and reel dimensions are provided in Figures 6 to 10 (even numbers).

## Package and Handling Information

Instructions on the shipping container label regarding exposure to moisture after the container seal is broken must be followed. Otherwise, problems related to moisture absorption may occur when the part is subjected to high temperature during solder assembly.

The SMV1405 to SMV1430 series of varactors are rated to Moisture Sensitivity Level 1 (MSL1) at 260 °C. They can be used for lead or lead-free soldering. For additional information, refer to the Skyworks Application Note, *Solder Reflow Information*, document number 200164.

Care must be taken when attaching this product, whether it is done manually or in a production solder reflow environment. Production quantities of this product are shipped in a standard tape and reel format.

**Table 2. SMV1405 to SMV1430 Series Absolute Maximum Ratings<sup>1</sup>**

Parameter	Symbol	Minimum	Maximum	Units
Reverse voltage	$V_R$		30	V
Forward current	$I_F$		20	mA
Power dissipation	$P_D$		250	mW
Operating temperature	$T_{OP}$	-55	+125	°C
Storage temperature	$T_{STG}$	-55	+150	°C

<sup>1</sup> Exposure to maximum rating conditions for extended periods may reduce device reliability. There is no damage to device with only one parameter set at the limit and all other parameters set at or below their nominal value. Exceeding any of the limits listed here may result in permanent damage to the device.

**ESD HANDLING:** Although this device is designed to be as robust as possible, electrostatic discharge (ESD) can damage this device. This device must be protected at all times from ESD when handling or transporting. Static charges may easily produce potentials of several kilovolts on the human body or equipment, which can discharge without detection. Industry-standard ESD handling precautions should be used at all times.

**Table 3. SMV1405 to SMV1430 Series Electrical Specifications<sup>1</sup>****( $T_{OP} = 25\text{ °C}$ , Unless Otherwise Noted)**

Part Number	$C_T @ 0.5\text{ V}$ (pF)	$C_T @ 1\text{ V}$ (pF)	$C_T @ 4\text{ V}$ (pF)		$\frac{C_T @ 0\text{ V}}{C_T @ 30\text{ V}}$ (Ratio)	$R_S @ 4\text{ V},$ 500 MHz ( $\Omega$ )	$Q @ 4\text{ V},$ 50 MHz
	Typ.	Typ.	Min.	Max.	Min	Max.	Typ.
SMV1405	2.1	1.80	1.21	1.45	4.1	0.80	3200
SMV1408	3.4	2.90	1.71	2.11	4.1	0.60	2900
SMV1413	7.4	6.40	3.64	4.42	4.2	0.35	2400
SMV1430	1.01	0.88	0.46	0.70	3.8	3.15	1680

<sup>1</sup> Performance is guaranteed only under the conditions listed in this table.

Reverse voltage  $V_R$  ( $I_R = 10\ \mu\text{A}$ ) = 30 V minimum

Reverse current  $I_R$  ( $V_R = 24\text{ V}$ ) = 20 nA maximum

Total capacitance shown was measured in the SOT-23 single configuration with a typical case capacitance of 0.13 pF. The total capacitance may differ slightly for other packages/configurations.

**Table 4. Capacitance vs Reverse Voltage<sup>1</sup>**

V <sub>R</sub> (V)	C <sub>T</sub> (pF)			
	SMV1405	SMV1408	SMV1413	SMV1430
0	2.67	4.08	9.24	1.24
0.5	2.12	3.36	7.39	1.01
1.0	1.84	2.94	6.37	0.88
1.5	1.70	2.60	5.71	0.80
2.0	1.55	2.38	5.22	0.74
2.5	1.44	2.24	4.85	0.68
3.0	1.34	2.08	4.55	0.65
4.0	1.25	1.88	4.10	0.60
5.0	1.17	1.72	3.77	0.56
10.0	0.95	1.28	2.85	0.44
20.0	0.77	1.01	2.12	0.35
30.0	0.63	0.95	1.77	0.31

<sup>1</sup> Total capacitance shown was measured in the SOT-23 single configuration with a typical case capacitance of 0.13 pF. The total capacitance may differ slightly for other packages/configurations.

### Typical Performance Characteristics

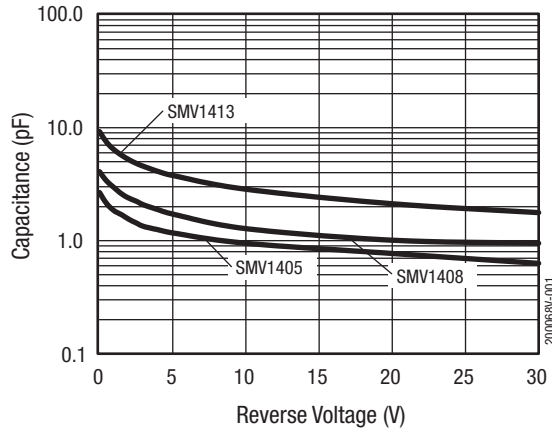

Figure 1. Capacitance vs Reverse Voltage

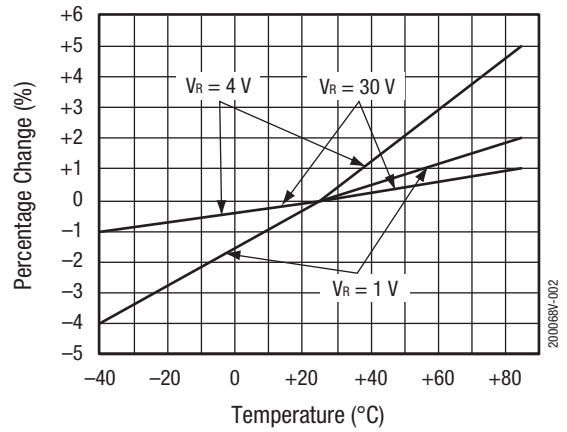

Figure 2. Relative Capacitance Change vs Temperature

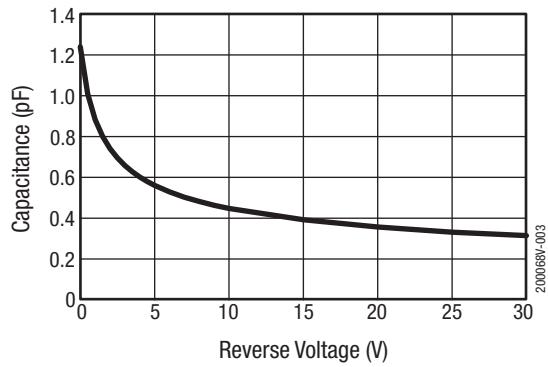

Figure 3. Capacitance vs Reverse Voltage (SMV1430)

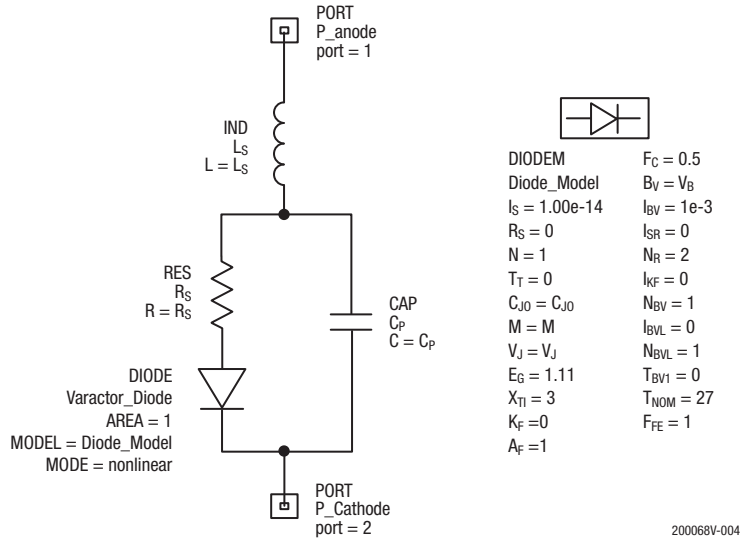

Figure 4. SPICE Model

Table 5. SPICE Model Parameters

Part Number	C <sub>J0</sub> (pF)	V <sub>J</sub> (V)	M	C <sub>P</sub> (pF)	R <sub>s</sub> (Ω)
SMV1405	2.37	0.77	0.5	0.29	0.80
SMV1408	3.89	0.92	0.5	0.21	0.60
SMV1413	8.92	0.87	0.5	0.30	0.35
SMV1430	1.11	0.86	0.5	0.13	3.15

Values extracted from measured performance.

For package inductance, L<sub>s</sub>, refer to Table 1.

For more details, refer to the Skyworks Application Note, *Varactor SPICE Model for Approved RF VCO Applications*, document number 200315.

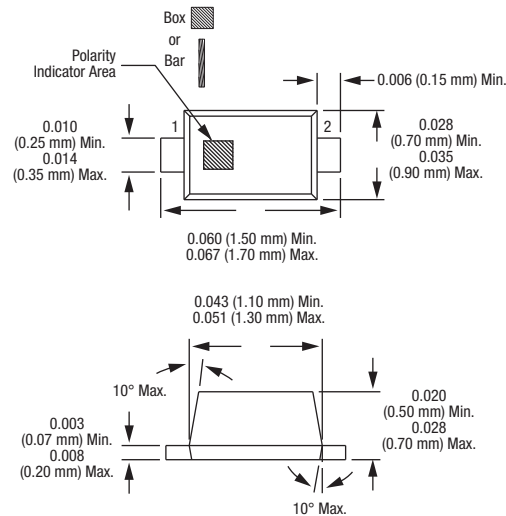

Dimensions are in inches (millimeters shown in parentheses) 200068V-005

Figure 5. SC-79 Package Dimensions

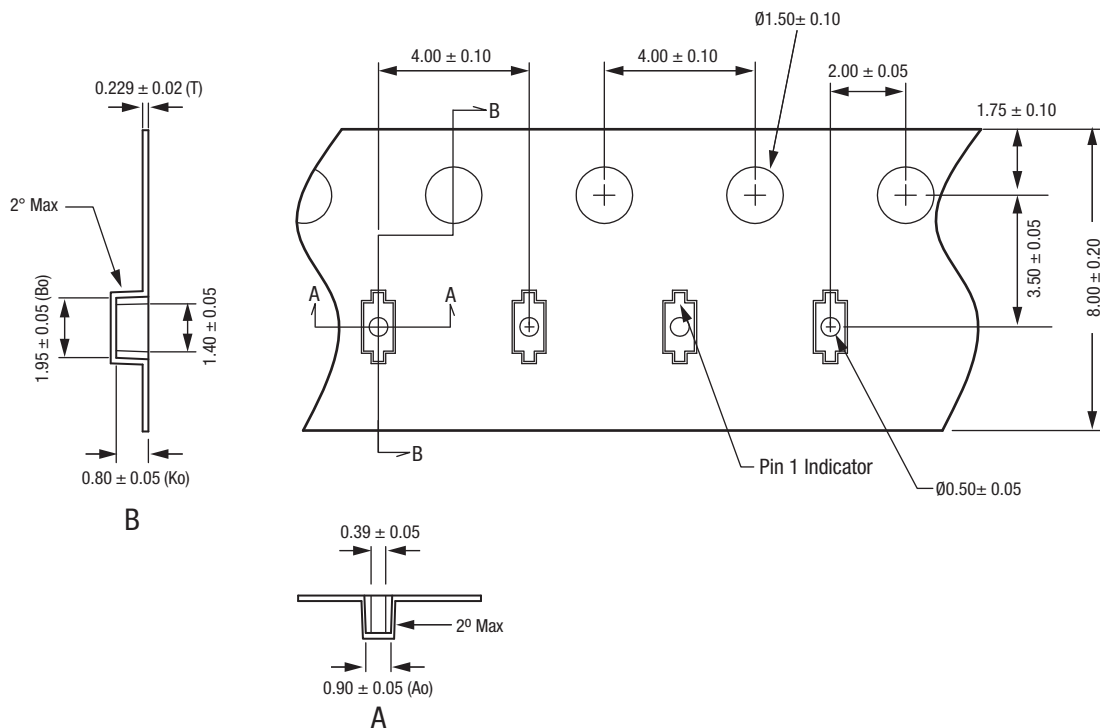

Notes:

1. Carrier tape: black conductive polycarbonate or polystyrene.
2. Cover tape material: transparent conductive PSA.
3. Cover tape size: 5.4 mm width.
4. ESD-surface resistivity is  $\leq 1 \times 10^8$  Ohms/square per EIA, JEDEC TNR Specification.
5. All measurements are in millimeters.

200068V-006

Figure 6. SC-79 Tape and Reel Dimensions

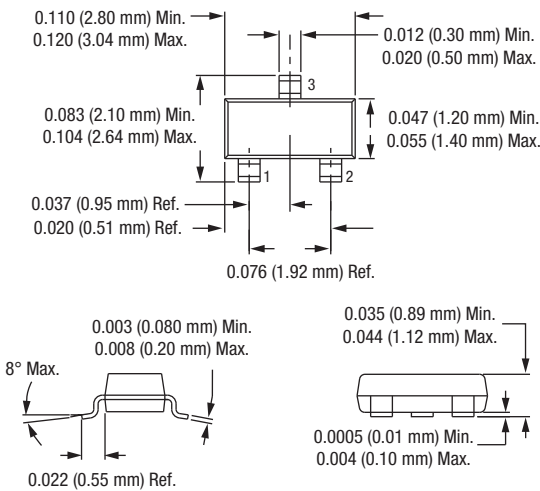

Dimensions are in inches (millimeters shown in parentheses) 200068V-007

Figure 7. SOT-23 Package Dimensions

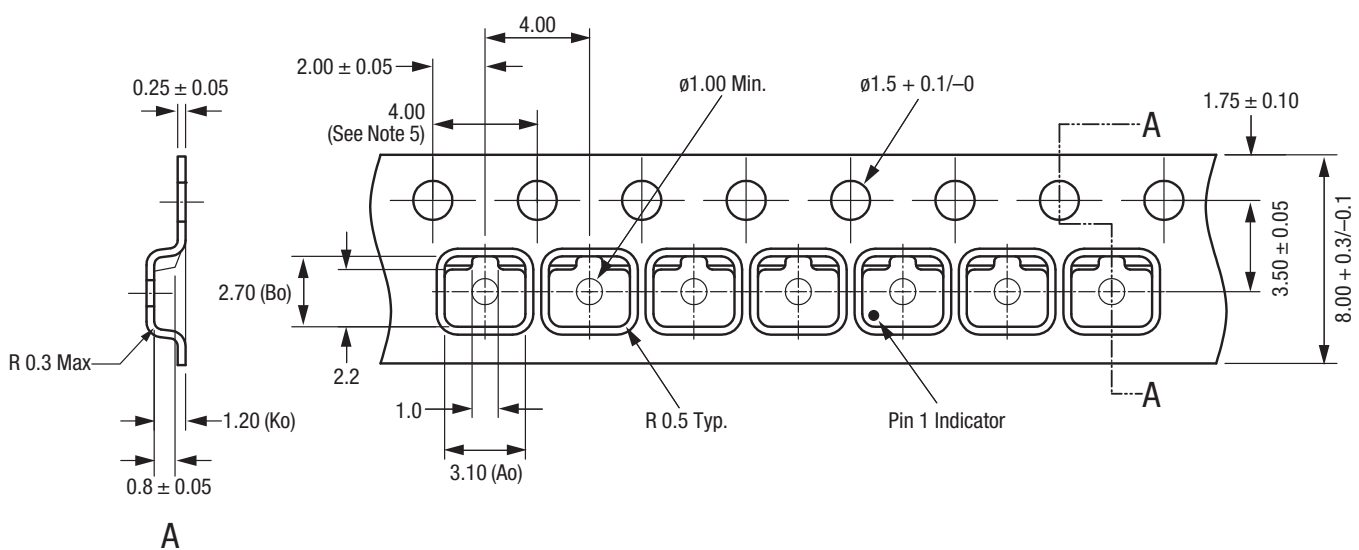

Notes:

1. Carrier tape: black conductive polycarbonate.
2. Cover tape material: transparent conductive PSA.
3. Cover tape size: 5.40 mm width.
4. Tolerance ±0.10 mm.
5. Ten sprocket hole pitch cumulative tolerance: ±0.2 mm.
6. All measurements are in millimeters.
7. Alternative carrier tape dimensions are:  
 $A_o = 3.3$   
 $B_o = 2.9$   
 $K_o = 1.22$

200068V-008

Figure 8. SOT-23 Tape and Reel Dimensions



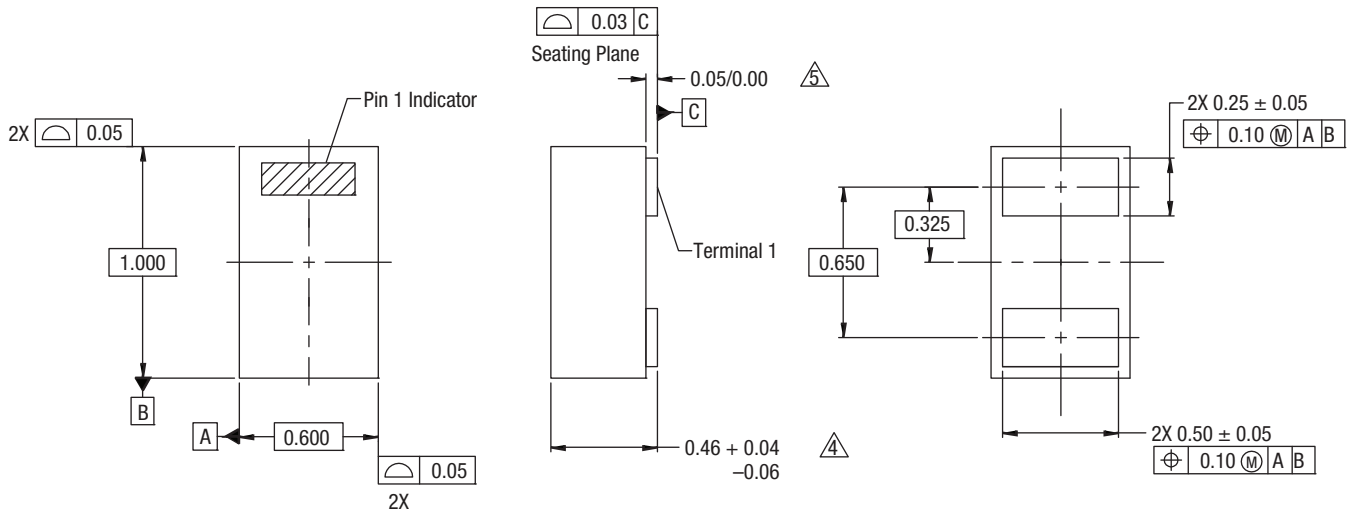

Notes:

1. All measurements are in millimeters.
2. Dimensions and tolerances according to ASME Y14.5M-1994.
3. These packages are used principally for discrete devices.
4. This dimension includes stand-off height and package body thickness, but does not include attached features, e.g., external heatsink or chip capacitors. An integral heatslug is not considered an attached feature.
5. This dimension is primarily terminal plating, but does not include small metal protrusion.

200068V-009

Figure 9. SOD-882 Package Dimensions

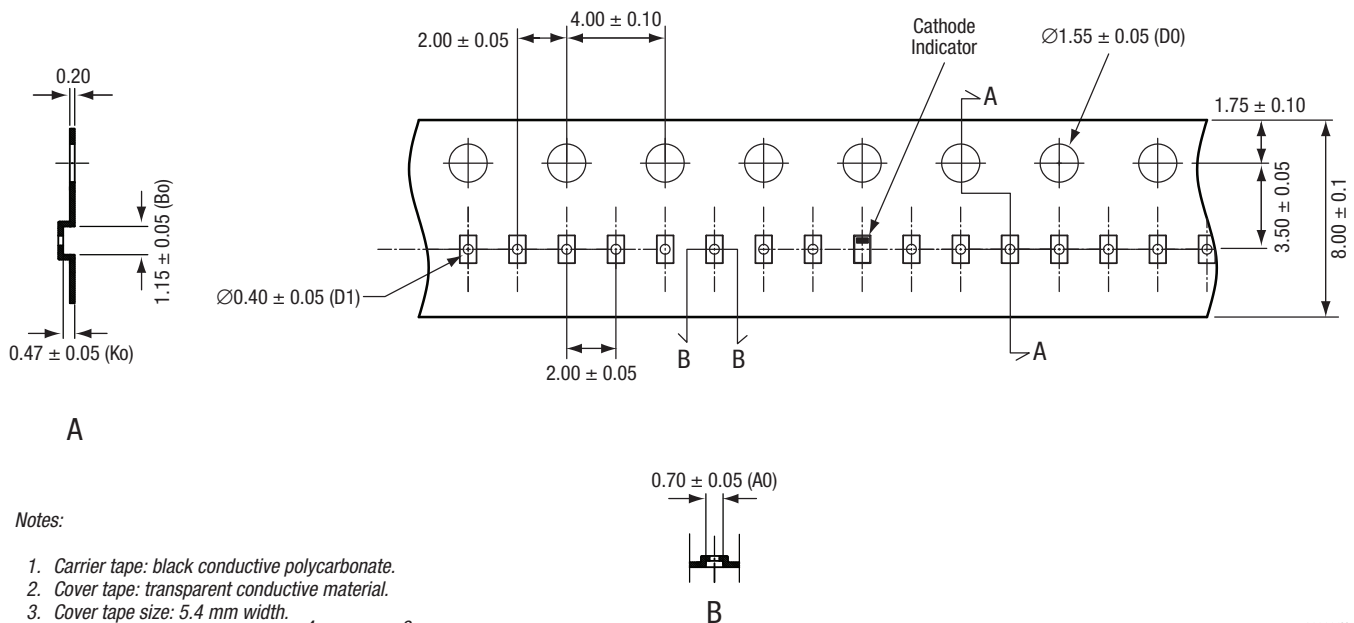

Notes:

1. Carrier tape: black conductive polycarbonate.
2. Cover tape: transparent conductive material.
3. Cover tape size: 5.4 mm width.
4. ESD surface resistivity is  $\geq 1 \times 10^4 \sim \leq 1 \times 10^8$  Ohms/square.
5. All dimensions are in millimeters.

200068V-010

Figure 10. SOD-882 Tape and Reel Dimensions