

HiBay LED Heat Sink

Wakefield-Vette's HiBay LED Heat Sink is the optimal choice for any of the industries LED array's that require a natural convection cooling method.

The unique mounting puck allows for machining patterns for historical, current, and future LED Module Hole Patterns for manufacturers such as Bridgelux, Cree, Dialight, Lumileds, etc.

The HiBay Series is available in different lengths as well as pre-machined for your specific array.

Part Number	x.xx Length Dimension (in.)
124212	6
124213	8
124214	10
124215	12



HiBay LED Heat Sink Assembly are identical with the exception of the overall extrusion length as identified with the x.xx dimension.

***Other Lengths Available Upon Request**

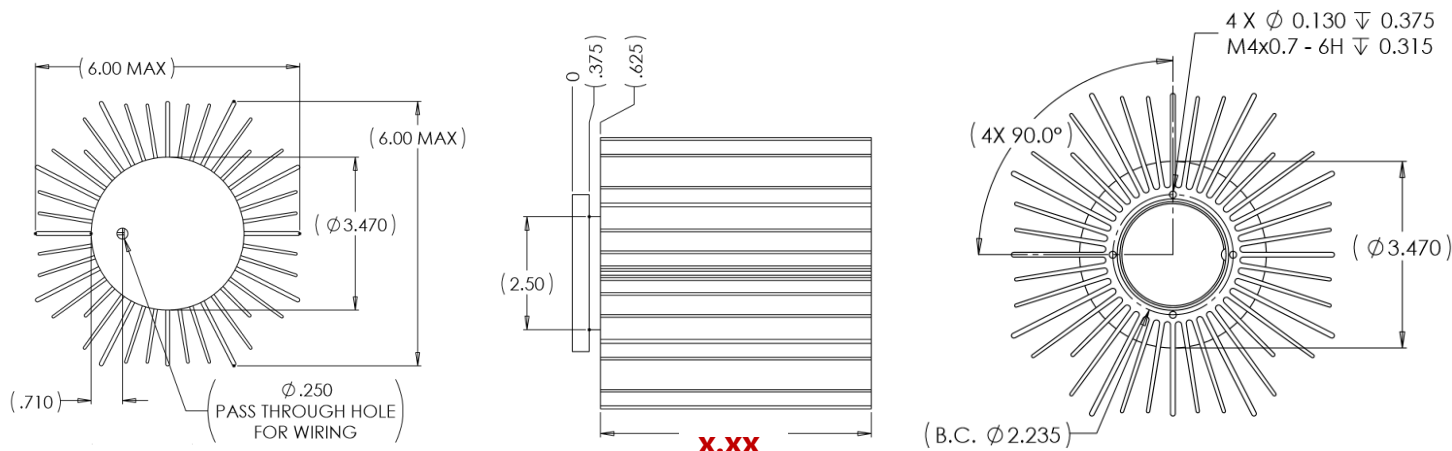

Thermal Performance

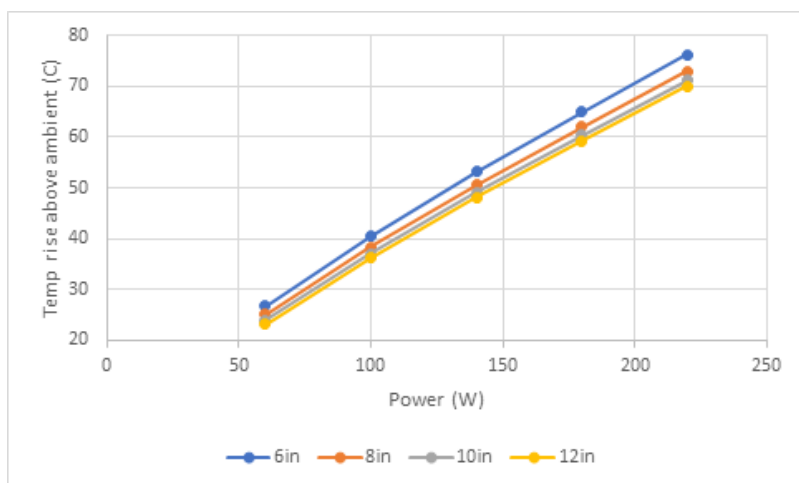

*Thermal Performance based on a 40mm LED device.



Contact Wakefield-Vette for Custom Machining Patterns

DUAL LED Heat Sink- Active & Passive w/ Fan Attachment

Wakefield- Vette's DUAL LED Series heat sinks are extremely versatile for a customer's application whether they require either an active or passive solutions. Each DUAL LED Heat Sink has a built-in option which lets the customer add a standard, silent fan in less than a minute, with just four screws, and get more than a *five-times improvement* in thermal resistance and wattage rating up to 750 watts.



Features:

- Single-Piece Forged-Aluminum Construction For Low Thermal Resistance & Compact Form-Factor
- Eleven Models Ranging from 58 mm to 225 mm Diameter with Thermal Resistance As Low As 0.35 Deg C/W For Passive Cooling up to 150 Watts
- Compatible with all SMD LED arrays, COBs, and “Driverless” AC-LED’s From All Major LED manufacturers

WKV Part Number	Diameter (mm)	Height (mm)	Passive Thermal Resistance (C/W)	Maximum LED Watts (@25C Ambient)	Active Thermal Res (C/W)*	Active Watts (@25C Ambient)
DUALLED-5830	58	30	5.90	6	1.18	48
DUALLED-5850	58	50	3.90	13	0.78	70
DUALLED-5880	58	80	3.35	15	0.67	85
DUALLED-6830	68	30	4.00	12	0.80	72
DUALLED-6850	68	50	3.20	16	0.64	90
DUALLED-6880	68	80	2.70	19	0.54	105
DUALLED-13030	130	30	2.80	18	0.56	102
DUALLED-13050	130	50	1.05	33	0.21	260
DUALLED-13080	130	80	0.83	60	0.17	340
DUALLED-19037	190	37	0.70	75	0.14	400
DUALLED-22560	225	60	0.35	150	0.08	750

*Contact Wakefield-Vette for Active Cooling Conditions and Recommendations

See following pages for High Performance Active Solutions

DUAL LED Heat Sink- Active & Passive w/ Fan Attachment



All DUAL LED heatsinks have pre-drilled and tapped holes in the baseplate so that a fan can be attached to the pin side (blowing air into the pins) with just four 6-62 screws of proper length (or longer screws with appropriate washers or spacers. Wakefield-Vette lists the DUAL LED heat sinks and suggested fan type to achieve silent operation and life expectancy approaching 100,000 hours. Please note that we recommend fans with dual-ball-bearing and DC brushless type motors.

For Use in Active Cooling Mode...

The heat sinks are manufactured to accept four 6-32 screws, which can be inserted through the four fan-mounting holes and into the four tapped holes in the baseplate. Fan power to achieve the rated thermal resistance should be < 1 Watt. Please contact Wakefield-Vette to discuss power supply and fan options.

Please take into consideration the heat sink total height and fan thickness when selecting the length of 6-32 screws to be used. If slightly longer screws are purposely used to ensure extension beyond the heat sink baseplate (>1/4"), then standard 6-32 hex standoffs can be employed to enable a variety of enclosure attachment/mounting methods.

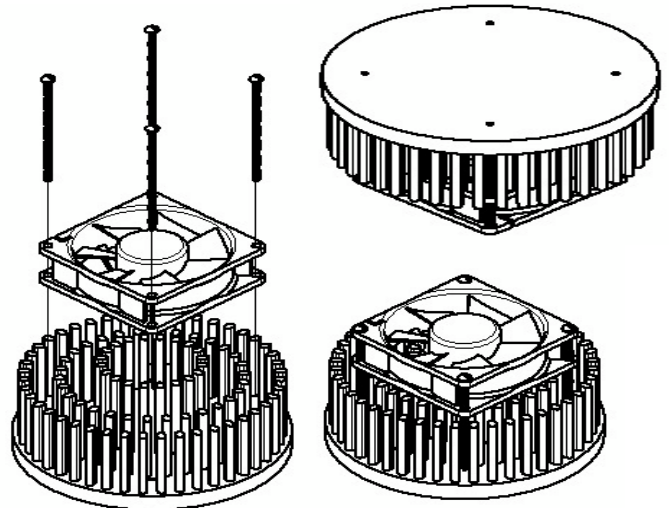

Recommended hardware for fan mounting in active-cooling mode:

WKV Part Number	Diameter (mm)	Height (mm)	Base Thickness (mm)	Fan Diameter (mm)	Active Thermal Res (C/W)*	Active Watts (@25C Ambient)
DUALLED-5830	58	30	5	40	1.18	48
DUALLED-5850	58	50	5	40	0.78	70
DUALLED-5880	58	80	5	40	0.67	85
DUALLED-6830	68	30	5	40	0.80	72
DUALLED-6850	68	50	5	40	0.64	90
DUALLED-6880	68	80	5	40	0.54	105
DUALLED-13030	130	30	10	80	0.56	102
DUALLED-13050	130	50	10	80	0.21	260
DUALLED-13080	130	80	10	80	0.17	340
DUALLED-19037	190	37	5	120	0.14	400
DUALLED-22560	225	60	10	120	0.08	750

Fan-attachment --Hole locations:

58mm diameter/40mm fan

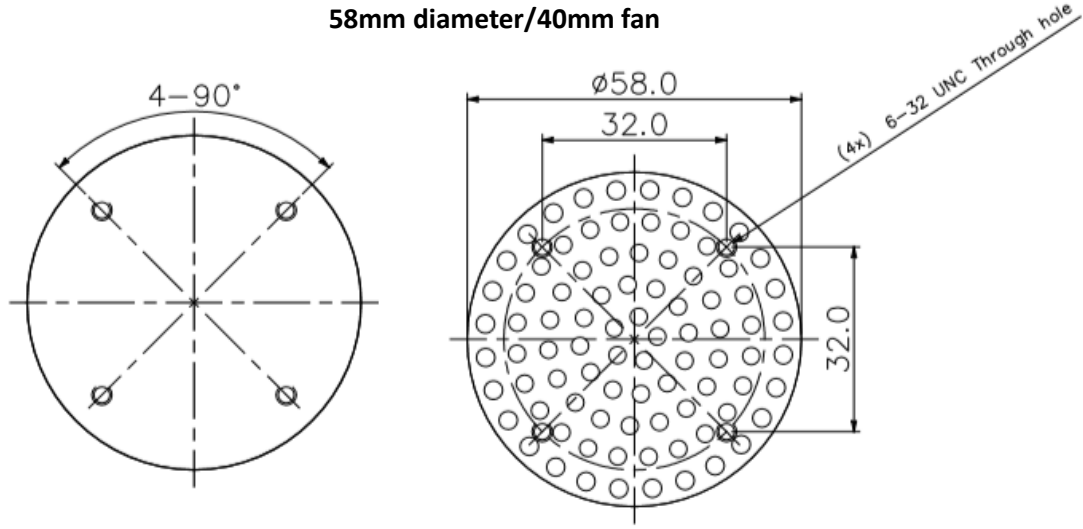

68 mm diameter/40mm fan

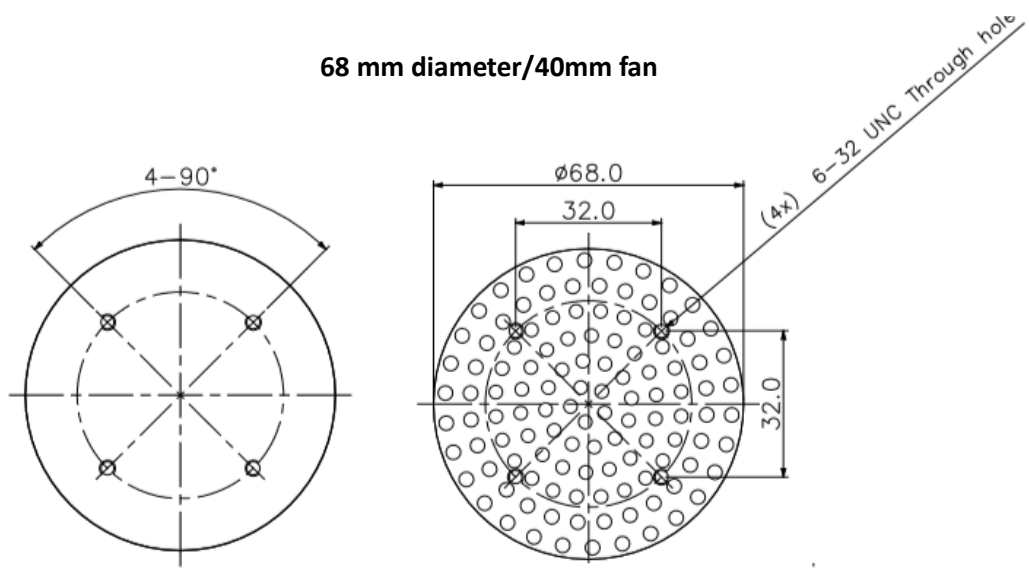

130 mm diameter/80mm fan

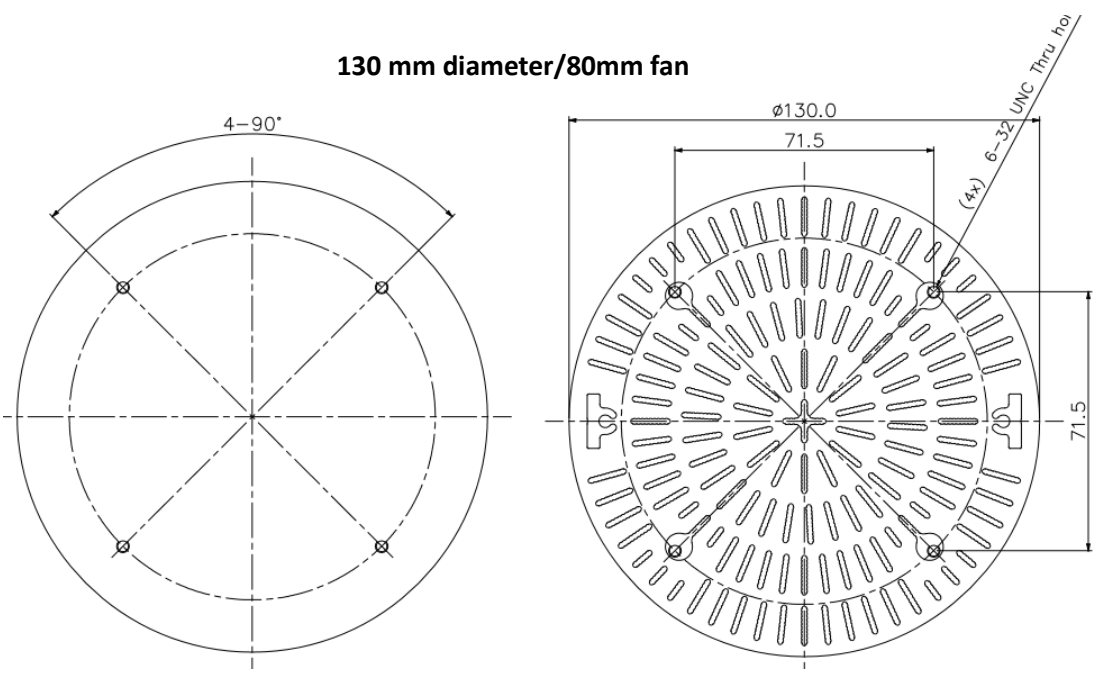

Fan-attachment --Hole locations (holes tapped for 6-32 thread):

190 mm diameter/120mm fan

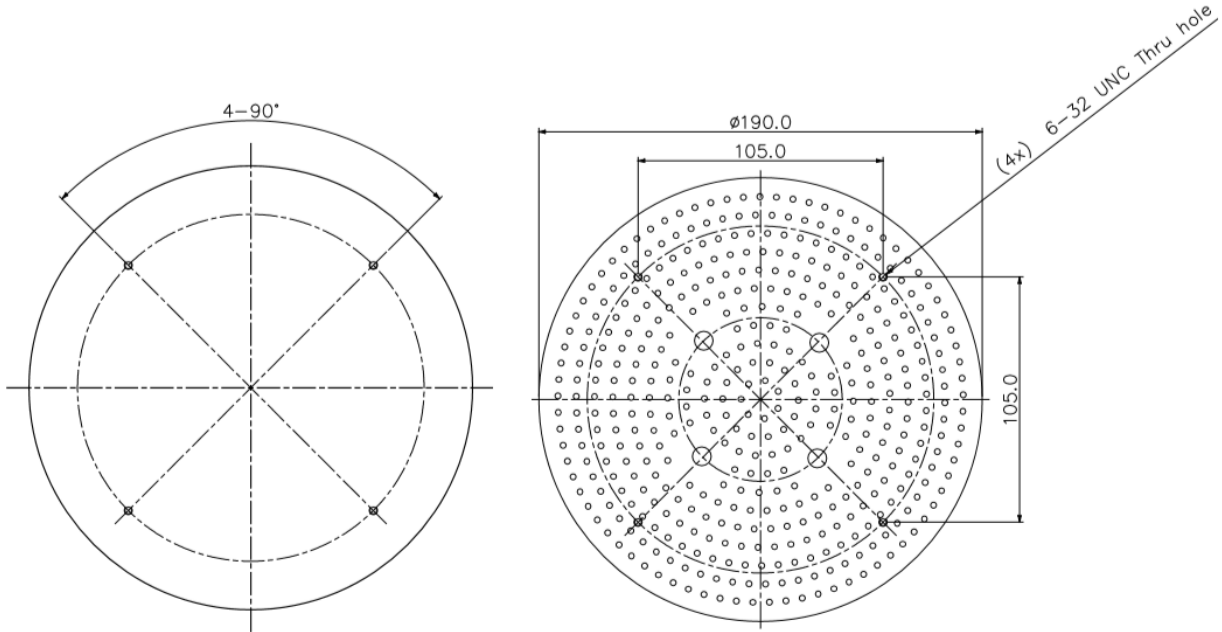

225 mm diameter/120mm fan

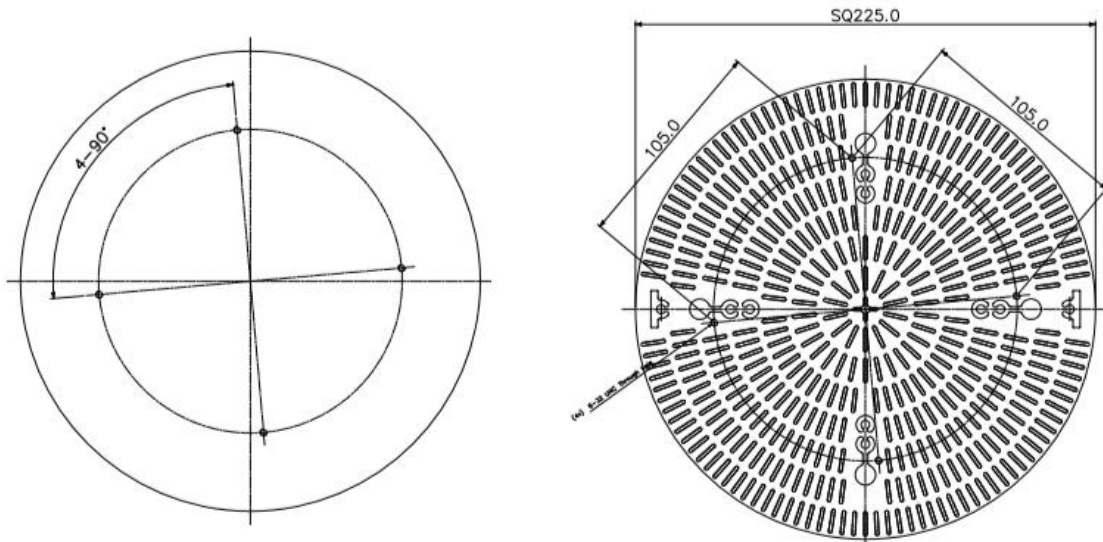

Features:

- Thermal resistance range R_{th} (7.69°C/W; 5.0°C/W; 4.17°C/W).
- Radial design with mounting holes foreseen for direct mounting of a wide range of LED modules and COB's: Diameter 48mm -110mm
- Extruded from highly conductive aluminum.
- Black anodized



Compatible with:

- Xicato XSM, XIM,XTM;
- Bridgelux ESS, ESR, Vero 10, Vero 13, Vero 18 V-series;
- Citizen CLL022-CLU024, CLL032-CLU034;
- Cree XLamp CXA13xx, CXA15xx, CSA18xx;
- Lumileds Luxeon COB's 1203, 1204, 1205, Luxeon K arrays K12, K16;
- Osram PrevaLED Core, SOLERIQ P and SOLERIQ S LED engines.
- Seoul Semiconductor ZC6, ZC12, ZC18, ZC25;
- Tridonic TALEXX module SLE modules;
- LG Innotek LEMWM18 10W, 13W, 17W
- Edison EdiLex SLM and EdiLex II COB LED engines.
- Lustrous LUSTRON 6 series LL604F, LL608D, LL613F, LL620F
- Prolight Opto PABS, PABA, PACB, PANA
- Samsung LC013, LC019, LC026 COB LED engines.
- SHARP Mini Zenigata Intermo and Mega Zenigata LED engines.
- Philips Fortimo SLM LED engines.
- Vossloh-Schwabe LUGA Shop LED engines.
- Luminus C##9, C##14 LED engines.

FLOWLED Heat Sink

38mm Diameter

WKV Part Number	Description	Height (mm)	Diameter (mm)	Max. Lumen (lm)	Dissipated Power (W)	Thermal Resistance (°C/W)	Weight (g)
FLOWLED-3820	Flow LED Heat Sink 38MM DIA 20H	20	38	630	4.5	7	24
FLOWLED-3850	Flow LED Heat Sink 38MM DIA 50H	50	980	7	11.4	60.9	

*Note: All Bases Have no Holes

No.	Finish	Mounting hole
A1	Green	19.0mm;2xM3@180°
A2	Dark Green	22.0mm;2xM3@180°
A3	Magenta	25.0mm;2xM3@180°
A4	Blue	26.9mm;2xM3@180°
A5	Light Green	28.3mm;2xM3@180°
A6	Yellow	31.4mm;2xM3@180°
A7	Bright Green	35.0mm;2xM3@180°

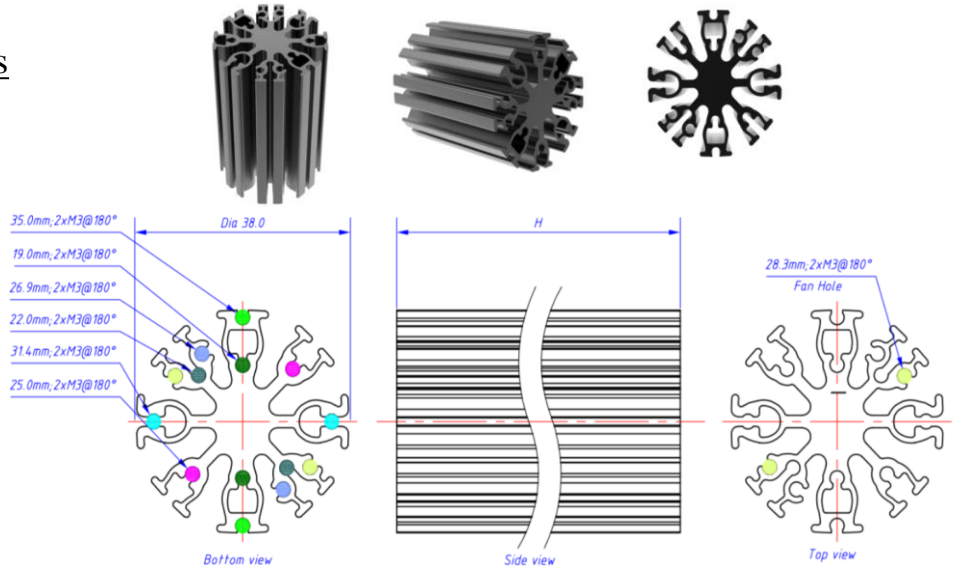

Thermal Data FLOWLED-3820

Dissipated Power Pd(W)	$P_d = P_e \times (1-\eta_L)$	Heat sink to ambient thermal resistance Rhs-amb (°C/W)	Heat sink to ambient temperature rise Ths-amb (°C)
	0.9	15.4	14
1.8	13.4	24.5	
2.7	12.4	34	
3.6	11.4	42	
4.5	10.9	50	

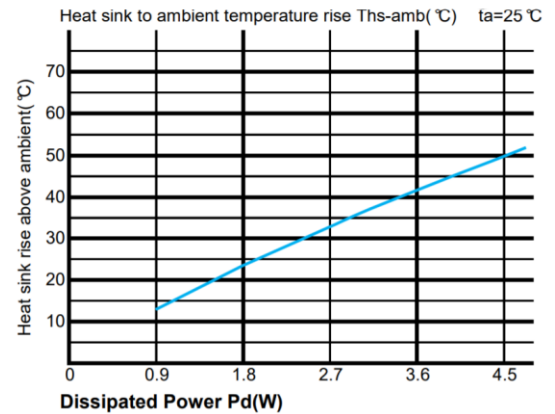

Thermal Data FLOWLED-3850

Dissipated Power Pd(W)	$P_d = P_e \times (1-\eta_L)$	Heat sink to ambient thermal resistance Rhs-amb (°C/W)	Heat sink to ambient temperature rise Ths-amb (°C)
	1.4	9.8	14
2.8	8.4	24	
4.2	7.7	33.2	
5.6	7.2	41.6	
7	6.9	49.5	

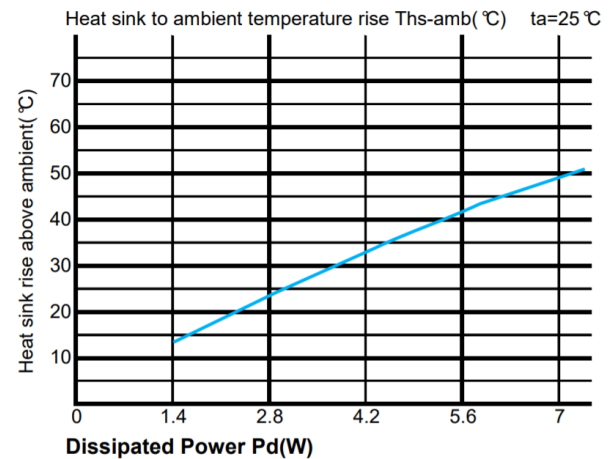

WKV Part Number	Description	Height (mm)	Diameter (mm)	Max. Lumen (lm)	Dissipated Power (W)	Thermal Resistance (°C/W)	Weight (g)
FLOWLED-7040	Flow LED Heat Sink 70MM DIA 40H	40	70	2700	19.6	2.3	183
FLOWLED-7080	Flow LED Heat Sink 70MM DIA 80H	80	3200	23	1.9	294	

*Note: All Bases Have no Holes

No.	Finish	Mounting hole
A1	●	25.0mm;2xM3@180°
A2	●	31.4mm;2xM3@180°
A3	●	35.0mm;2xM3@180°
A4	●	39.0mm;3xM3@120°
A5	●	42.0mm;3xM3@120°
A6	●	42.5mm;2xM3@180°
A7	●	45.0mm;2xM3@180°
A8	●	56.6mm;4xM3@90°
A9	●	14.0mm;2xM3
A10	●	18.3mm;2xM2

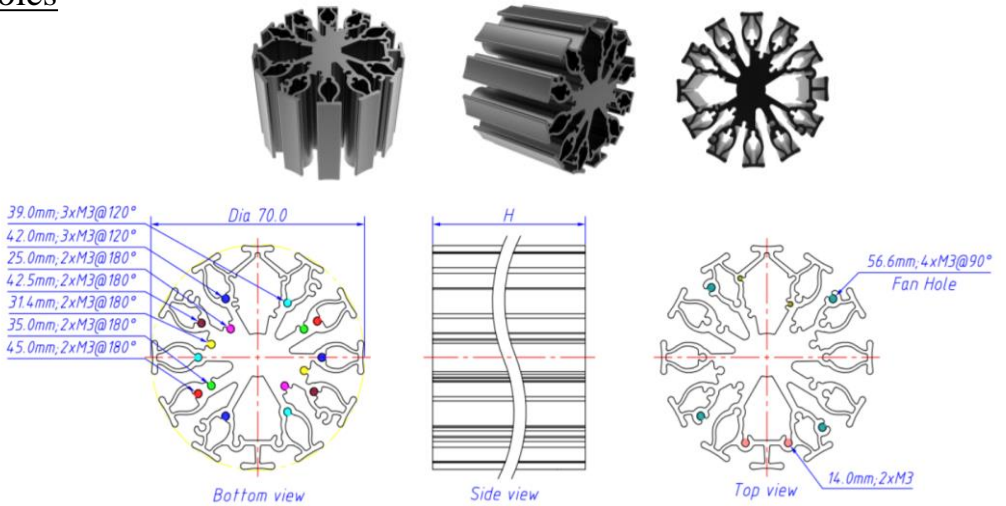

Thermal Data FLOWLED-7040

Dissipated Power Pd(W)	$P_d = P_e \times (1-\eta_L)$	Heat sink to ambient thermal resistance Rhs-amb (°C/W)	Heat sink to ambient temperature rise Ths-amb (°C)
	4		3.4
8		2.9	25
12		2.6	34.4
16		2.5	43
20		2.3	51

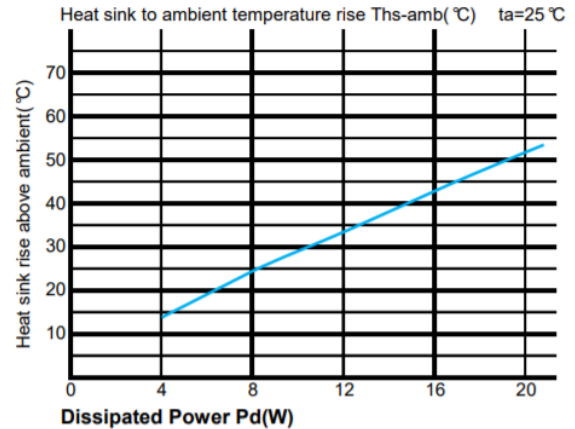

Thermal Data FLOW

Dissipated Power Pd(W)	$P_d = P_e \times (1-\eta_L)$	Heat sink to ambient thermal resistance Rhs-amb (°C/W)	Heat sink to ambient temperature rise Ths-amb (°C)
	4.6		2.8
9.2		2.4	24
13.8		2.2	33
18.4		2	41.5
23		1.9	49

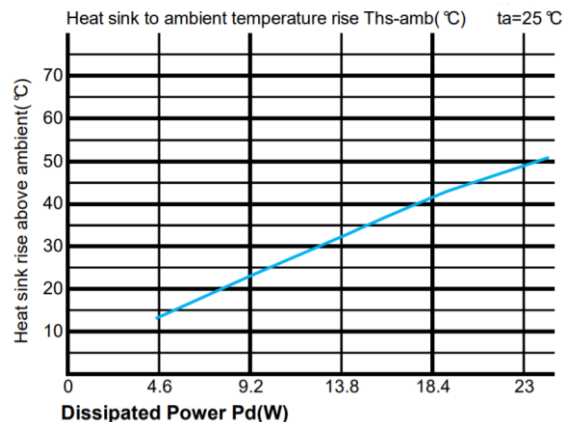

WKV Part Number	Description	Height (mm)	Diameter (mm)	Max. Lumen (lm)	Dissipated Power (W)	Thermal Resistance (°C/W)	Weight (g)
FLOWLED-8540	Flow LED Heat Sink 85MM DIA 40H	40	85	3600	26	1.9	249
FLOWLED-8560	Flow LED Heat Sink 85MM DIA 60H	60	4440	32	1.6	398	

*Note: All Bases Have no Holes

No.	Finish	Mounting hole
A1		25.0mm;2xM3@180°
A2		31.4mm;2xM3@180°
A3		35.0mm;2xM3@180°
A4		39.0mm;3xM3@120°
A5		42.0mm;3xM3@120°
A6		42.5mm;2xM3@180°
A7		45.0mm;2xM3@180°
A8		70.7mm;4xM3@90°
A9		14.0mm;2xM3
A10		22.2mm;2xM2

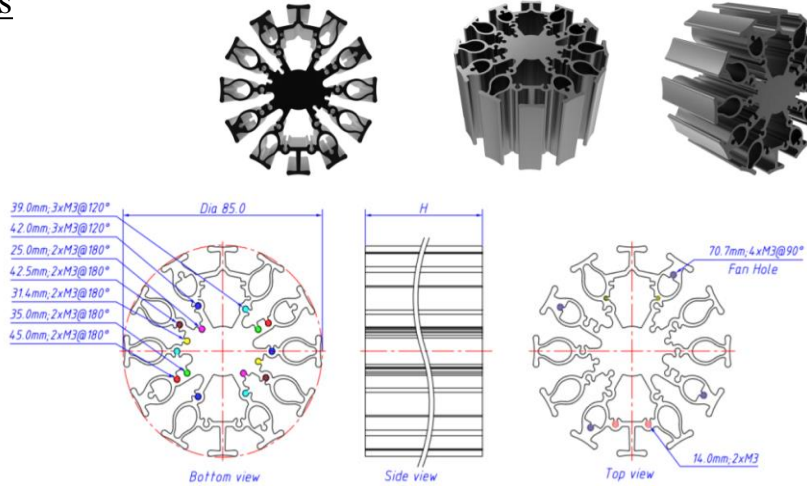

Thermal Data FLOWLED-8540

Dissipated Power Pd(W)	Pd = Pe x (1-ηL)	
	Heat sink to ambient thermal resistance Rhs-amb (°C/W)	Heat sink to ambient temperature rise Ths-amb (°C)
5.2	2.5	14
10.4	2.1	24
15.6	1.9	33
20.8	1.9	43.5
26	1.7	50

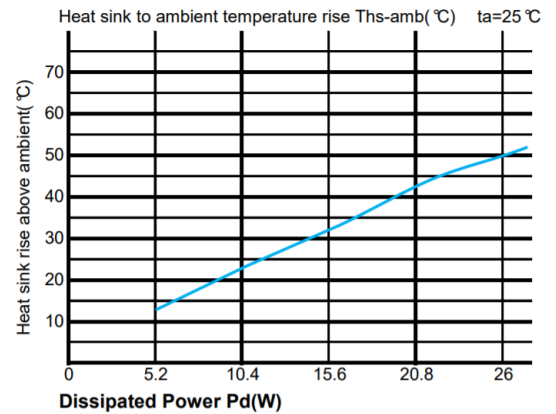

Thermal Data FLOWLED-8560

Dissipated Power Pd(W)	Pd = Pe x (1-ηL)	
	FanLED-8580	FanLED-8580
6.4	2	14
12.8	1.7	24
19.2	1.6	34
25.6	1.4	42
32	1.3	50

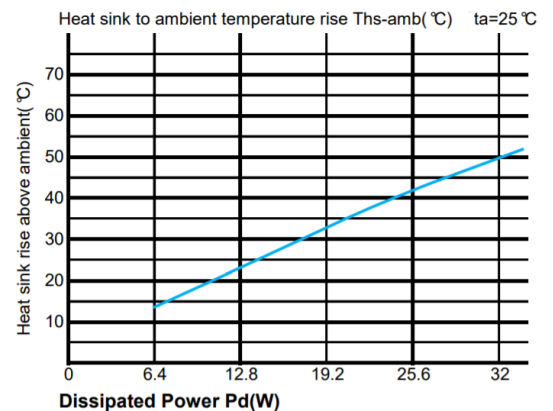

WKV Part Number	Description	Height (mm)	Diameter (mm)	Max. Lumen (lm)	Dissipated Power (W)	Thermal Resistance (°C/W)	Weight (g)
FLOWLED-9650	Flow LED Heat Sink 96MM DIA 50H	50	96	4400	32	1.5	312
FLOWLED-9680	Flow LED Heat Sink 96MM DIA 90H	80	5600	40	1.2	499	

*Note: All Bases Have no Holes

No.	Finish	Mounting hole
A1	●	25.0mm;2xM3@180°
A2	●	31.4mm;2xM3@180°
A3	●	35.0mm;2xM3@180°
A4	●	39.0mm;3xM3@120°
A5	●	42.0mm;3xM3@120°
A6	●	42.5mm;2xM3@180°
A7	●	45.0mm;2xM3@180°
A8	●	70.7mm;4xM3@90°
A9	●	82.0mm;4xM3@90°
A10	●	14.0mm;2xM3
A11	●	22.2mm;2xM2

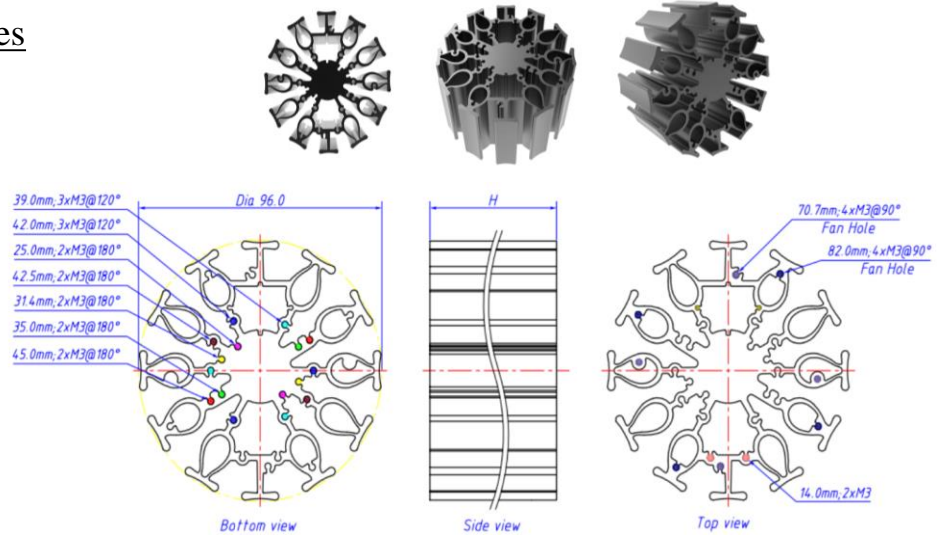

Thermal Data FLOWLED-9650

Dissipated Power Pd(W)	Pd = Pe x (1-ηL)	
	Heat sink to ambient thermal resistance Rhs-amb (°C/W)	Heat sink to ambient temperature rise Ths-amb (°C)
6.4	1.9	14
12.8	1.7	24
19.2	1.5	33.5
25.6	1.4	42
32	1.3	50

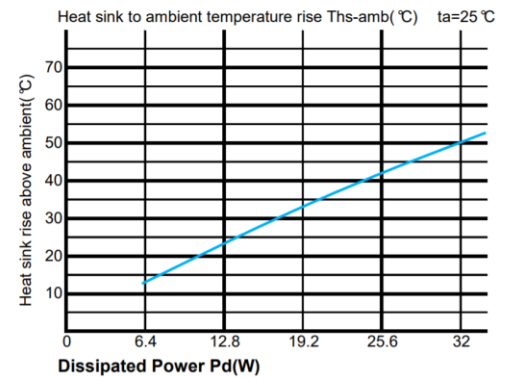

Thermal Data FLOWLED-9680

Dissipated Power Pd(W)	Pd = Pe x (1-ηL)	
	Heat sink to ambient thermal resistance Rhs-amb (°C/W)	Heat sink to ambient temperature rise Ths-amb (°C)
8	1.5	14
16	1.3	24
24	1.2	34
32	1.1	42
40	1.0	50

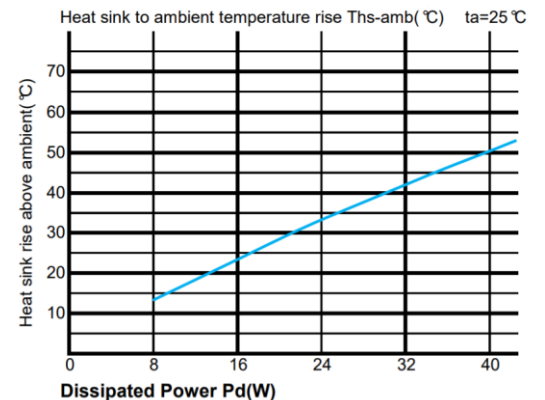

PADLED Heat Sink

Wakefield- Vette's PADLED is designed with 99.7% high-purity aluminum cold forging process. The design of the series is simple and gorgeous, and the blade is rectangular in a radial pattern, which makes the convection heat dissipation reasonable. This heat sink also has 4 PCS holes on top. This is compatible with Light Modules such as Edison, Xicato, Bridgelux, Osram, Lumileds, Cree, Tridonic, LG, Lustrous, Prolight, Samsung, SHARP, Luminus and Philips.

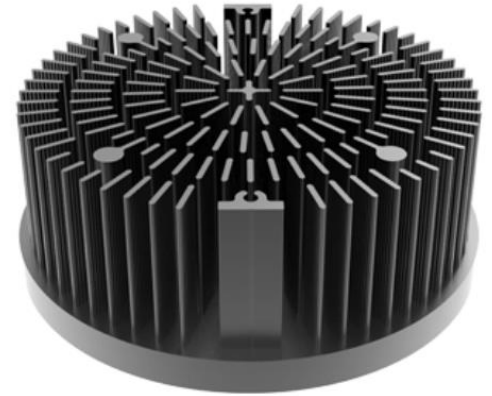

Features:

- Mechanical compatibility with direct mounting of the LED modules to the LED cooler and thermal performance matching the lumen packages
- Side fins to be frilled M3 or M4 Holes
- Several Diameters, Several Standard heights
- Forged from highly conductive aluminum
- Black Anodized
- Blank surface with no holes to mount any device listed below

Compatible with:

- Bridelux: Vero 18/22 Vero SE 18/29 LED engines;
- Cree: XLamp CXA 25xx, XLamp CXB 25xx, CXA 30xx, XLamp CXB 30xx LED engines;
- Citizen: CLU036, CLU038, CLU721, CLU711, CLU046, CLU048, CLU731 LED engines;
- Edison: EdiLex III COB LED engines;
- GE lighting: Infusion™ LED engines;
- LG Innotek: 32W, 42W, 56W LED engines;
- LumiLEDs: LUXEON 1211, LUXEON 1216, LUXEON 1812, LUXEON 1825 LED engines;
- Lumens: Ergon-COB-2530, 2540, 3050, 3070 LED engines;
- Luminus: CXM-18, CLM-22, CXM-22 LED engines;
- Nichia: NFCWL036B, NFCLL036B, NFCWL060B, NFCLL060B LED engines;
- Osram: SOLERIQ® S 19, Core series LED engines;
- Philips: Fortimo SLM LED engines;
- Prolight Opto: PABS, PABA, PACB, PANA LED engines;
- Samsung: LC026B, LC033B, LC040B, LC040D, LC060D, LC080D LED engines;
- Seoul Semiconductor: Acrich MJT COBs, DC COB LED engines;
- Tridonic: SLE G6 19mm, SLE G6 23mm LED engines;
- Vossloh-Schwabe: LUGA Shop and LUGA C LED engines;
- Xicato: XSM, XIM, XTM LED engines;

PADED Heat Sink

130mm Diameter

WKV Part Number	Description	Height (mm)	Diameter (mm)	Max. Lumen (lm)	Dissipated Power (W)	Thermal Resistance (°C/W)	Weight (g)
PADLED-13080	PAD LED Heat Sink 130MM DIA 80H	80	130	4600	33	1.5	492
PADLED-130100	PAD LED Heat Sink 130MM DIA 100H	100	6700	48	1	625	

*Note: All Bases Have no Holes



Thermal Data PADLED-13080

Dissipated Power Pd(W)	$P_d = P_e \times (1-\eta_L)$	
	Heat sink to ambient thermal resistance Rhs-amb (°C/W)	Heat sink to ambient temperature rise Ths-amb (°C)
15.0	1.13	17.0
30.0	0.93	28.0
45.0	0.89	40.0
60.0	0.83	50.0
75.0	0.77	58.0

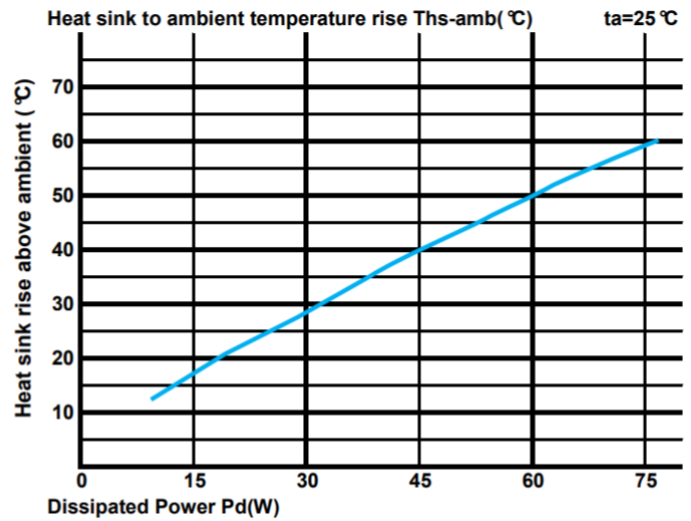

Thermal Data PADLED-130100

Dissipated Power Pd(W)	$P_d = P_e \times (1-\eta_L)$	
	Heat sink to ambient thermal resistance Rhs-amb (°C/W)	Heat sink to ambient temperature rise Ths-amb (°C)
20.0	1.10	22.0
40.0	0.90	36.0
60.0	0.78	47.0
80.0	0.73	58.0
100.0	0.66	66.0

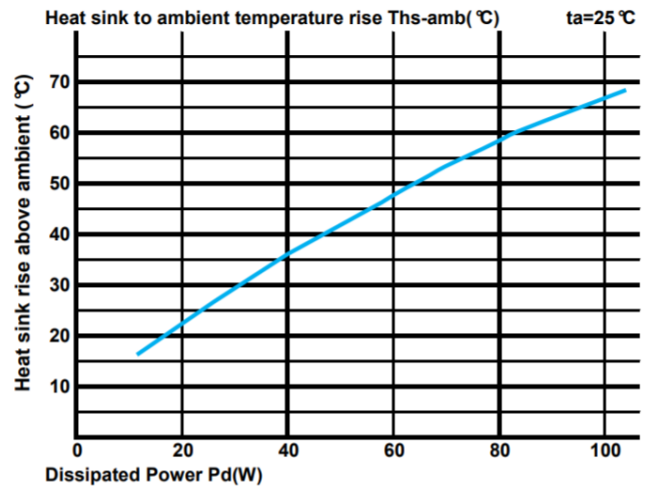

PADED Heat Sink

165mm Diameter

WKV Part Number	Description	Height (mm)	Diameter (mm)	Max. Lumen (lm)	Dissipated Power (W)	Thermal Resistance (°C/W)	Weight (g)
PADLED-16580	PAD LED Heat Sink 165MM DIA 80H	80	165	15000	95	0.52	1550
PADLED-165100	PAD LED Heat Sink 165MM DIA 100H	100	16800	120	0.4	1700	

*Note: All Bases Have no Holes

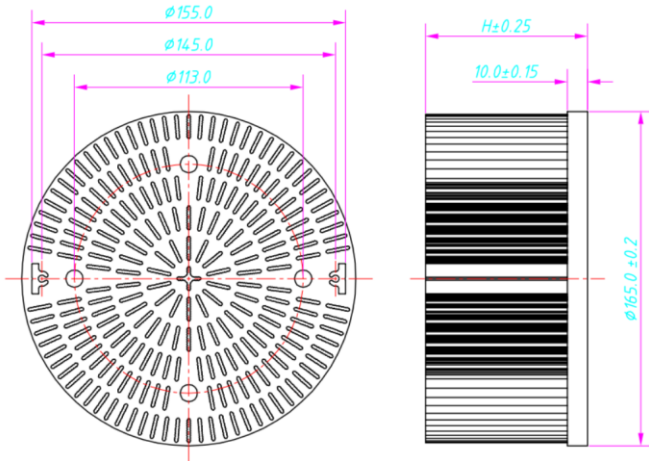
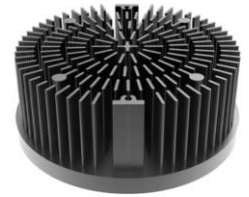
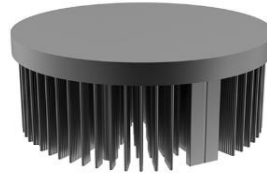

Thermal Data PADLED-16580

Dissipated Power Pd(W)	Pd = Pe x (1-ηL)		Heat sink to ambient thermal resistance Rhs-amb (°C/W)	Heat sink to ambient temperature rise Ths-amb (°C)
	30.0	60.0	0.78	23.5
60.0			0.63	38.0
90.0			0.52	47.0
120.0			0.51	61.0
150.0			0.49	73.0

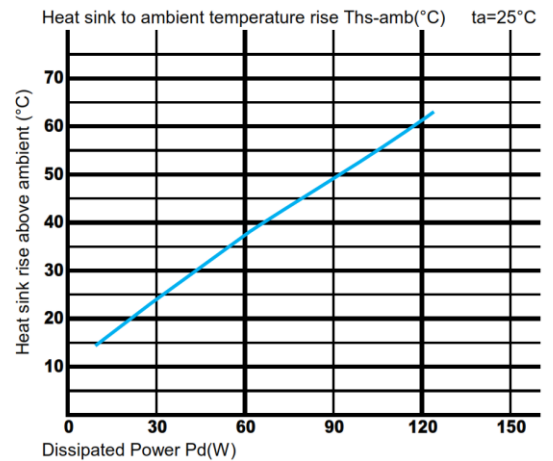

Thermal Data PADLED-165100

Dissipated Power Pd(W)	Pd = Pe x (1-ηL)		Heat sink to ambient thermal resistance Rhs-amb (°C/W)	Heat sink to ambient temperature rise Ths-amb (°C)
	30.0	60.0	0.60	18.0
60.0			0.48	29.0
90.0			0.44	40.0
120.0			0.42	50.0
150.0			0.41	61.0

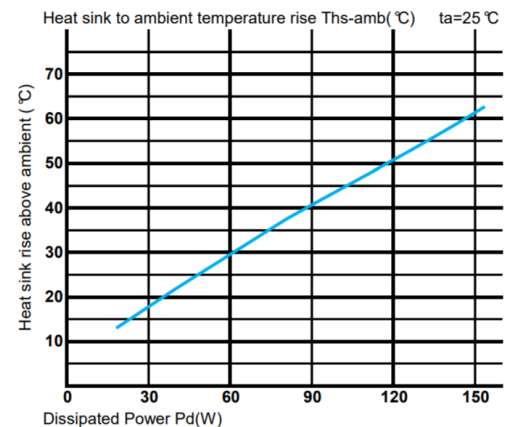

PADED Heat Sink

225mm Diameter

WKV Part Number	Description	Height (mm)	Diameter (mm)	Max. Lumen (lm)	Dissipated Power (W)	Thermal Resistance (°C/W)	Weight (g)
PADLED-22560	PAD LED Heat Sink 225MM DIA 60H	60	225	21000	150	0.3	2220
PADLED-225100	PAD LED Heat Sink 225MM DIA 100H	100	28000	200	0.2	3150	

*Note: All Bases Have no Holes



Thermal Data PADLED-22560

Dissipated Power Pd(W)	$P_d = P_e \times (1-\eta_L)$	
	Heat sink to ambient thermal resistance Rhs-amb (°C/W)	Heat sink to ambient temperature rise Ths-amb (°C)
40.0	0.53	21.0
80.0	0.41	33.0
120.0	0.37	44.0
160.0	0.33	53.0
200.0	0.32	63.0

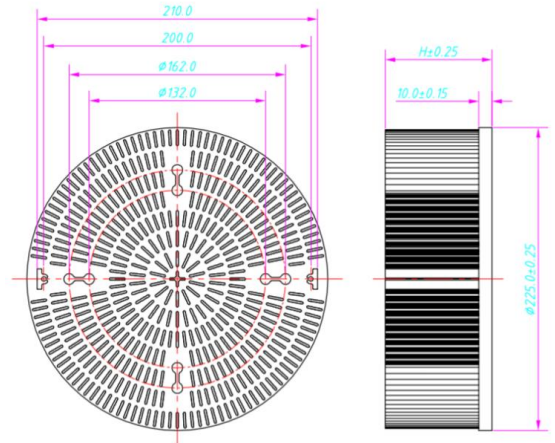
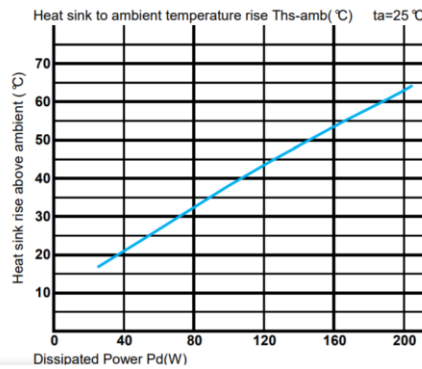

Thermal Data PADLED-225100

Dissipated Power Pd(W)	$P_d = P_e \times (1-\eta_L)$	
	Heat sink to ambient thermal resistance Rhs-amb (°C/W)	Heat sink to ambient temperature rise Ths-amb (°C)
50.0	0.40	20.0
100.0	0.32	32.0
150.0	0.29	43.0
200.0	0.26	52.0
250.0	0.24	61.0

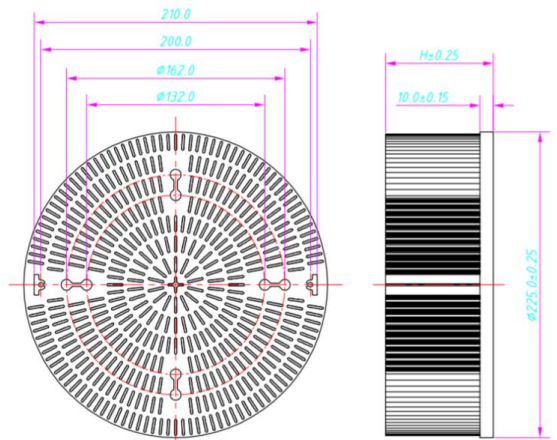
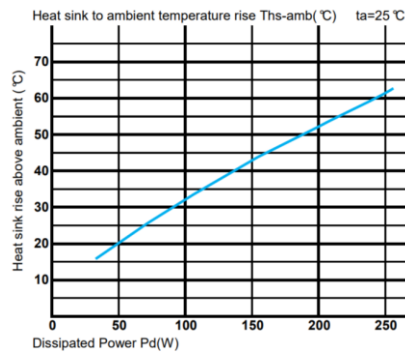

PINLED Heat Sink

Wakefield- Vette's PinLED is designed with 99.7% high-purity aluminum cold forging process. The design of the series is simple and gorgeous, and the blade is cylindrical, which makes the convection heat dissipation reasonable. This is compatible with Light Modules such as Edison, Xicato, Bridgelux, Osram, Lumileds, Cree, Tridonic, LG, Lustrous, Prolight, Samsung, SHARP, Luminus and Philips.



Features:

- Mechanical compatibility with direct mounting of the LED modules to the LED cooler and thermal performance matching the lumen packages
- Several Diameters, Several Standard heights
- Forged from highly conductive aluminum
- Black Anodized
- Blank surface with no holes to mount any device listed below

Compatible with:

- Xicato XSM, XIM,XTM
- Bridgelux ESS, ESR, Vero 10, Vero 13, Vero 18 V-series
 - Citizen CLL024-CLU028, CLL034-CLU038
 - Cree XLamp CXA13xx, CXA15xx, CSA18xx
- Lumileds Luxeon COB's 1203, 1204, 1205, Luxeon K arrays K12, K16
- Osram PrevaLED Core, SOLERIQ P and SOLERIQ S LED engines
 - Seoul Semiconductor ZC6, ZC12, ZC18, ZC25
 - Tridonic TALEXXmodule SLE modules
 - LG Innotek LEMWM18 10W, 13W, 17W
- Edison EdiLex SLM and EdiLex II COB LED engines
- Lustrous LUSTRON 6 series LL604F, LL608D, LL613F, LL620F
 - Prolight Opto PABS, PABA, PACB, PANA
 - Samsung LC013, LC019, LC026 COB LED engines
- SHARP Mini Zenigata Intermo and Mega Zenigata LED engines
 - Philips Fortimo SLM LED engines
 - Vossloh-Schwabe LUGA Shop LED engines
 - Luminus C##9, C##14 LED engines

WKV Part Number	Description	Height (mm)	Diameter (mm)	Max. Lumen (lm)	Dissipated Power (W)	Thermal Resistance (°C/W)	Weight (g)
PINLED-4830	Pin LED Heat Sink 48MM DIA 30H	30	48	1100	8	6.25	46
PINLED-4850	Pin LED Heat Sink 48MM DIA 50H	50	1400	10	5	64	

***Note: All Bases Have no Holes**



No.	Finish	Mounting Hole
A1	Orange	17.0 mm 2xM3 @ 180°
A2	Red	19.0 mm 2xM3 @ 180°
A3	Purple	20.2 mm 2xM3 @ 180°
A4	Yellow	21.7 mm 2xM3 @ 180°
A5	Pink	25.0 mm 2xM3 @ 180°
A6	Blue	26.8 mm 2xM3 @ 180°
A7	Grey	31.4 mm 2xM3 @ 180°
A8	Green	35.0 mm 2xM3 @ 180°
A9	Brown	39.0 mm 3xM3 @ 120°
A10	Cyan	42.0 mm 3xM3 @ 120°
A11		⊙Ø8.5 Through hole @ Ø48.0

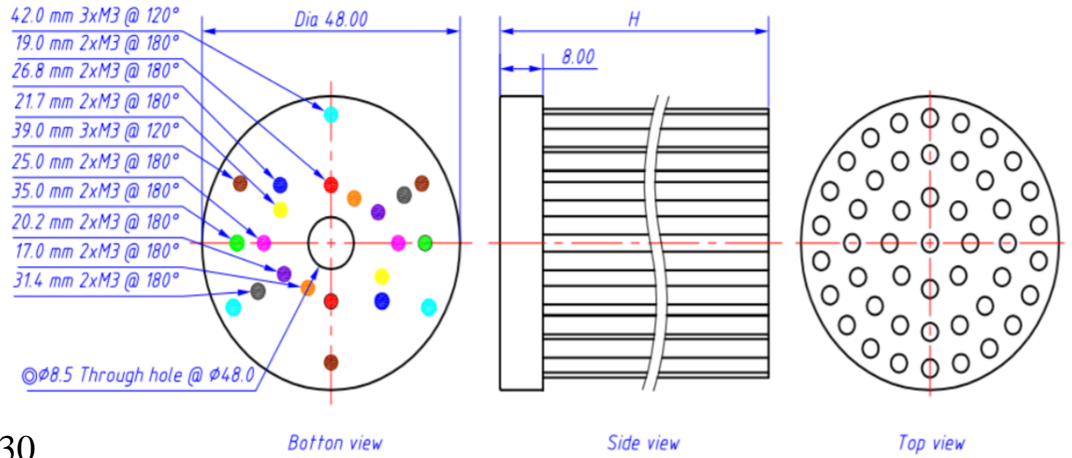

Thermal Data PINLED-4830

Dissipated Power Pd(W)	Pd = Pe x (1-ηL)		Heat sink to ambient thermal resistance Rhs-amb (°C/W)	Heat sink to ambient temperature rise Ths-amb (°C)
	2	4		
2	9	18		
4	7.5	30		
6	7	42		
8	6.25	50		
10	5.9	59		

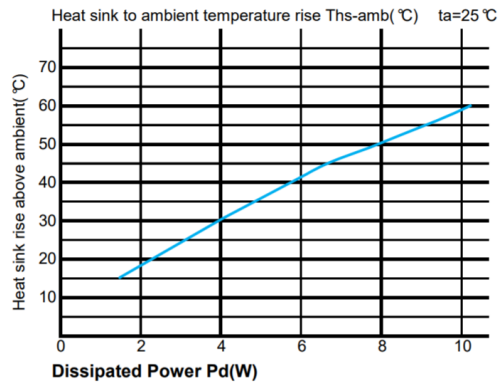

Thermal Data PINLED-4850

Dissipated Power Pd(W)	Pd = Pe x (1-ηL)		Heat sink to ambient thermal resistance Rhs-amb (°C/W)	Heat sink to ambient temperature rise Ths-amb (°C)
	2	4		
2	7	14		
4	6.25	25		
6	5.67	34		
8	5.38	43		
10	5	50		

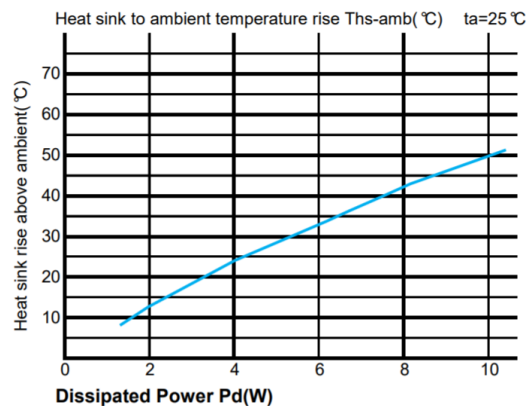

WKV Part Number	Description	Height (mm)	Diameter (mm)	Max. Lumen (lm)	Dissipated Power (W)	Thermal Resistance (°C/W)	Weight (g)
PINLED-5830	Pin LED Heat Sink 58MM DIA 30H	30	58	1400	10	5	79
PINLED-5850	Pin LED Heat Sink 58MM DIA 50H	50	1800	13	3.85	108	

***Note: All Bases Have no Holes**

No.	Finish	Mounting Hole
A1	Orange	17.0 mm 2xM3 @ 180°
A2	Red	19.0 mm 2xM3 @ 180°
A3	Purple	20.2 mm 2xM3 @ 180°
A4	Yellow	21.7 mm 2xM3 @ 180°
A5	Magenta	25.0 mm 2xM3 @ 180°
A6	Blue	26.8 mm 2xM3 @ 180°
A7	Grey	31.4 mm 2xM3 @ 180°
A8	Green	35.0 mm 2xM3 @ 180°
A9	Brown	39.0 mm 3xM3 @ 120°
A10	Cyan	42.0 mm 3xM3 @ 120°
A11		⊙Ø11.5 Through hole @ Ø58.0

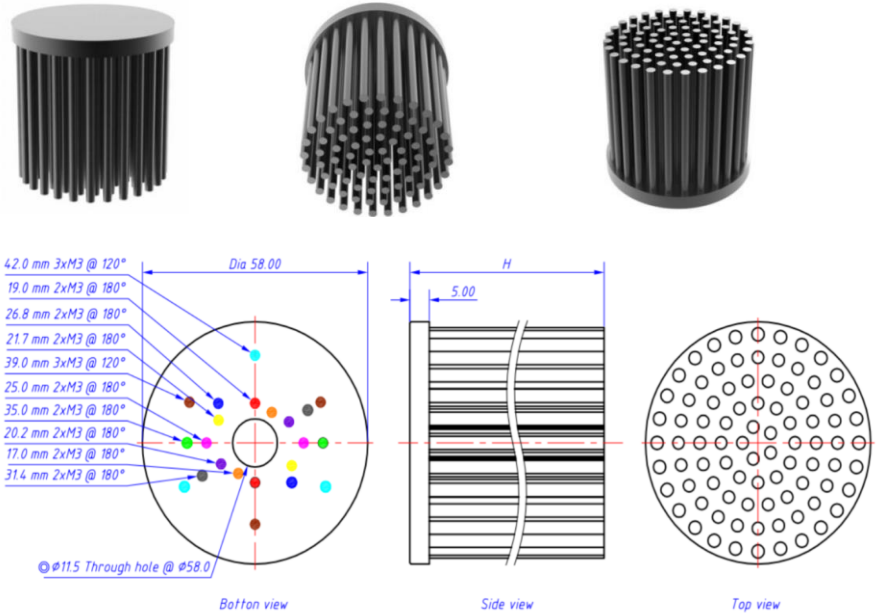

Thermal Data PINLED-5830

Dissipated Power Pd(W)	$P_d = P_e \times (1-\eta_L)$	Heat sink to ambient thermal resistance Rhs-amb (°C/W)	Heat sink to ambient temperature rise Ths-amb (°C)
	3		6.67
6		5.83	35
9		5.11	46
12		4.75	57
15		4.67	70

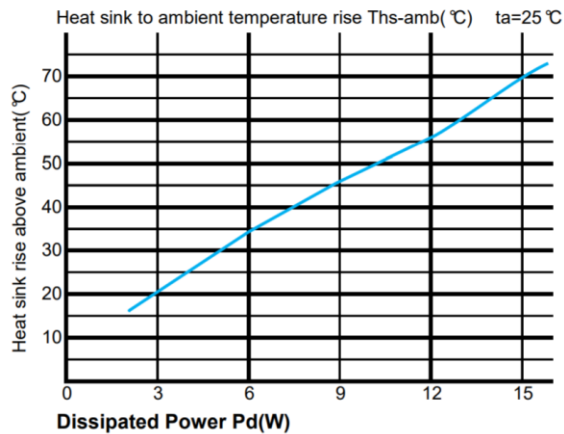

Thermal Data PINLED-5850

Dissipated Power Pd(W)	$P_d = P_e \times (1-\eta_L)$	Heat sink to ambient thermal resistance Rhs-amb (°C/W)	Heat sink to ambient temperature rise Ths-amb (°C)
	3		5
6		4.67	26
9		4.33	39
12		4	46
15		3.8	57

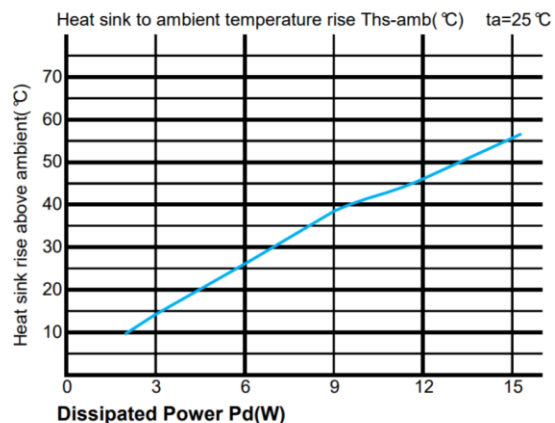

WKV Part Number	Description	Height (mm)	Diameter (mm)	Max. Lumen (lm)	Dissipated Power (W)	Thermal Resistance (°C/W)	Weight (g)
PINLED-6830	Pin LED Heat Sink 68MM DIA 30H	30	68	1900	12.5	4	77
PINLED-6860	Pin LED Heat Sink 68MM DIA 60H	60	2800	15.5	3.23	192	

***Note: All Bases Have no Holes**

No.	Finish	Mounting Hole
A1	Orange	17.0 mm 2xM3 @ 180°
A2	Red	19.0 mm 2xM3 @ 180°
A3	Purple	20.2 mm 2xM3 @ 180°
A4	Yellow	21.7 mm 2xM3 @ 180°
A5	Magenta	25.0 mm 2xM3 @ 180°
A6	Blue	26.8 mm 2xM3 @ 180°
A7	Light Green	29.7 mm 2xM3 @ 180°
A8	Grey	31.4 mm 2xM3 @ 180°
A9	Green	35.0 mm 2xM3 @ 180°
A10	Brown	39.0 mm 3xM3 @ 120°
A11	Cyan	42.0 mm 3xM3 @ 120°
A12		⊙ Ø11.5 Through hole @ Ø68.0

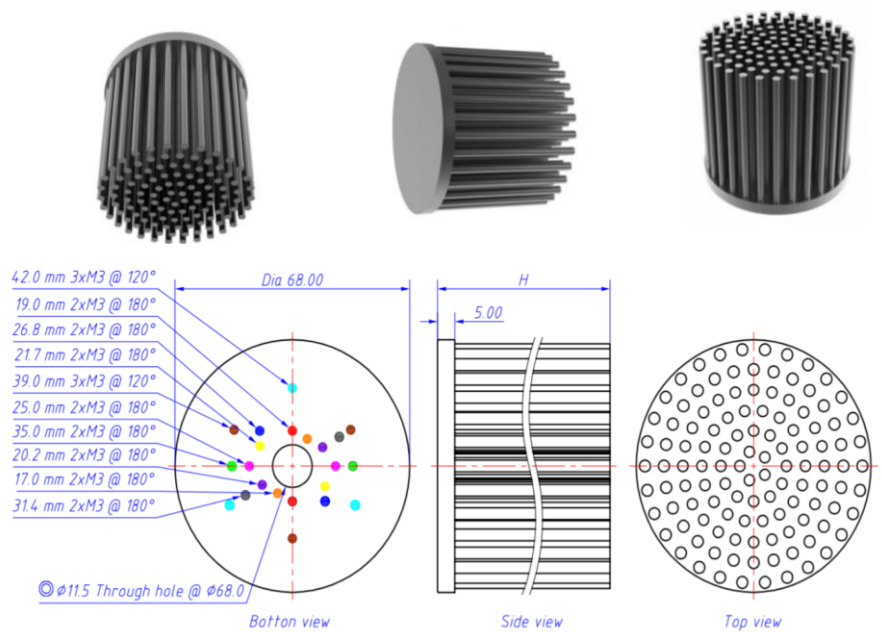

Thermal Data PINLED-6830

Dissipated Power Pd(W)	Pd = Pe x (1-ηL)	
	Heat sink to ambient thermal resistance Rhs-amb (°C/W)	Heat sink to ambient temperature rise Ths-amb (°C)
3	5.67	17
6	4.67	28
9	4.44	40
12	4.08	49
15	3.87	58

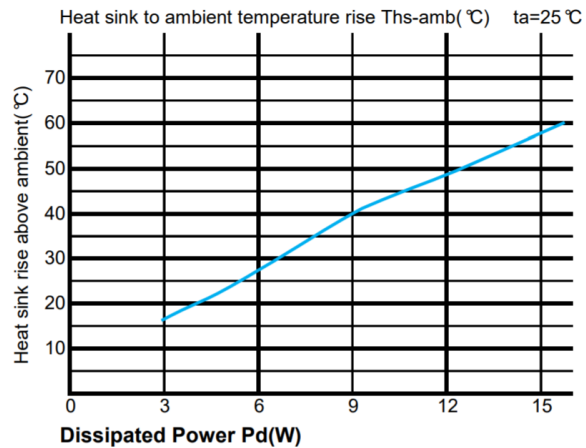

Thermal Data PINLED-6860

Dissipated Power Pd(W)	Pd = Pe x (1-ηL)	
	Heat sink to ambient thermal resistance Rhs-amb (°C/W)	Heat sink to ambient temperature rise Ths-amb (°C)
4	4.25	17
8	3.75	30
12	3.42	41
16	3.25	52
20	3	60

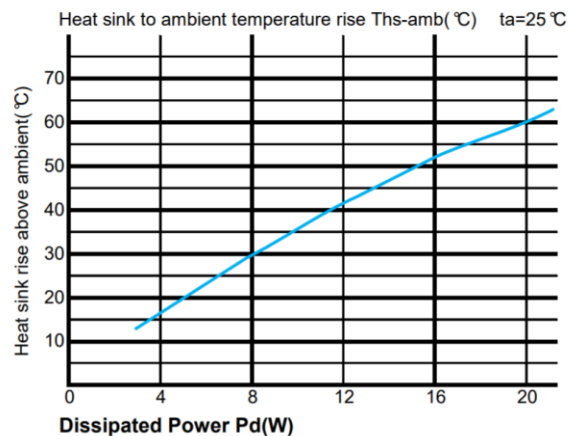

WKV Part Number	Description	Height (mm)	Diameter (mm)	Max. Lumen (lm)	Dissipated Power (W)	Thermal Resistance (°C/W)	Weight (g)
PINLED-7830	Pin LED Heat Sink 78MM DIA 30H	30	78	2300	16.5	3.03	138
PINLED-7850	Pin LED Heat Sink 78MM DIA 50H	50	2900	21.5	2.33	197	

***Note: All Bases Have no Holes**

No.	Finish	Mounting Hole
A1	Orange	17.0 mm 2xM3 @ 180°
A2	Red	19.0 mm 2xM3 @ 180°
A3	Purple	20.2 mm 2xM3 @ 180°
A4	Yellow	21.7 mm 2xM3 @ 180°
A5	Pink	25.0 mm 2xM3 @ 180°
A6	Blue	26.8 mm 2xM3 @ 180°
A7	Pink	29.7 mm 2xM3 @ 180°
A8	Grey	31.4 mm 2xM3 @ 180°
A9	Green	32.2 mm 2xM3 @ 180°
A10	Light Green	35.0 mm 2xM3 @ 180°
A11	Brown	39.0 mm 3xM3 @ 120°
A12	Cyan	42.0 mm 3xM3 @ 120°
A13	Blue	43.0 mm 4xM3 @ 90°
A14	Light Green	58.4 mm 4xM3.5 @ 4-360°
A15		⊙ Ø11.5 Through hole @ Ø78.0

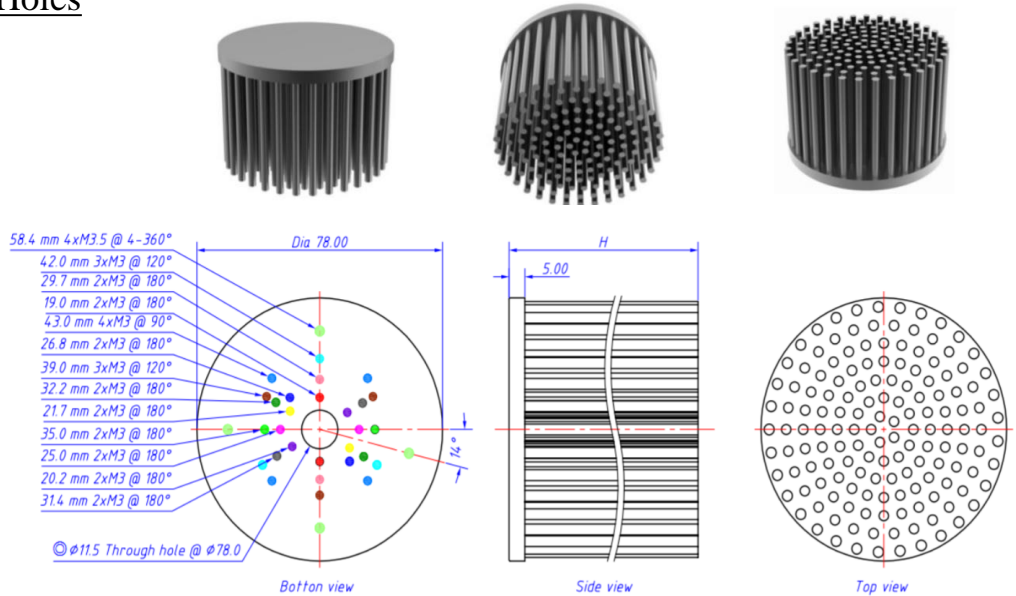

Thermal Data PINLED-7830

Dissipated Power Pd(W)	$P_d = P_e \times (1-\eta_L)$	Heat sink to ambient thermal resistance Rhs-amb (°C/W)	Heat sink to ambient temperature rise Ths-amb (°C)
	5		4.8
10		3.6	36
15		3.13	47
20		2.95	59
25		2.72	68

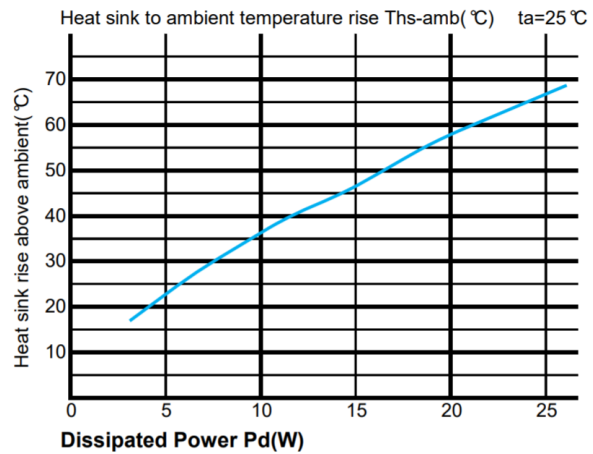

Thermal Data PINLED-7850

Dissipated Power Pd(W)	$P_d = P_e \times (1-\eta_L)$	Heat sink to ambient thermal resistance Rhs-amb (°C/W)	Heat sink to ambient temperature rise Ths-amb (°C)
	6		3.5
12		2.67	32
18		2.44	44
24		2.25	54
32		1.97	63

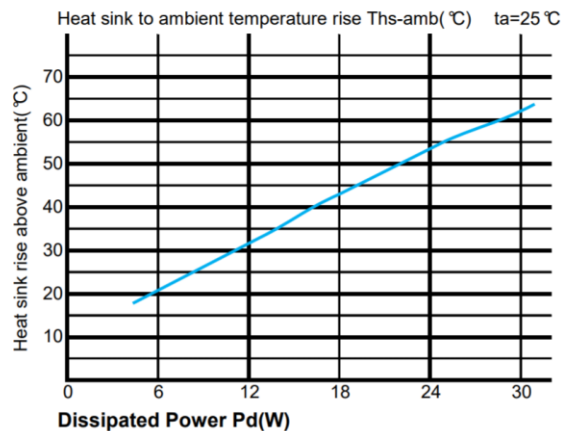

Features:

- Thermal resistance range $R_{th}(7.69^{\circ}\text{C}/\text{W}; 5.0^{\circ}\text{C}/\text{W}; 4.17^{\circ}\text{C}/\text{W})$.
- Modular design with mounting holes foreseen for direct mounting of LED modules and COB's: Diameter 48mm -110mm
- Extruded from highly conductive aluminum
- Black anodized



Compatible with:

- Xicato XSM, XIM, XTM;
- Bridgelux ESS, ESR, Vero 10, Vero 13, Vero 18 V-series;
- Citizen CLL022-CLU024, CLL032-CLU034;
- Cree XLamp CXA13xx, CXA15xx, CSA18xx;
- Lumileds Luxeon COB's 1203, 1204, 1205, Luxeon K arrays K12, K16;
- Osram PrevaLED Core, SOLERIQ P and SOLERIQ S LED engines.
- Seoul Semiconductor ZC6, ZC12, ZC18, ZC25;
- Tridonic TALEXXmodule SLE modules;
- LG Innotek LEMWM18 10W, 13W, 17W
- Edison EdiLex SLM and EdiLex II COB LED engines.
- Lustrous LUSTRON 6 series LL604F, LL608D, LL613F, LL620F
- Prolight Opto PABS, PABA, PACB, PANA
- Samsung LC013, LC019, LC026 COB LED engines.
- SHARP Mini Zenigata Intermo and Mega Zenigata LED engines.
- Philips Fortimo SLM LED engines.
- Vossloh-Schwabe LUGA Shop LED engines.
- Luminus C##9, C##14 LED engines.

WKV Part Number	Description	Height (mm)	Diameter (mm)	Max. Lumen (lm)	Dissipated Power (W)	Thermal Resistance (°C/W)	Weight (g)
SPIRLED-4850	SPIR LED Heat Sink 48MM DIA 50H	50	48	1400	10	5	134

*Note: All Bases Have no Holes

No.	Finish	Mounting Hole
H1	Red	17.0 mm 2xM2.5 @ 180°
H2	Magenta	17.4 mm 2xM2.5 @ 180°
H3	Blue	19.0 mm 2xM3 @ 180°
H4	Cyan	20.2 mm 2xM3 @ 180°
H5	Yellow	21.7 mm 2xM3 @ 180°
H6	Green	22.0 mm 2xM2.5 @ 180°
H7	Grey	24.0 mm 2xM3 @ 180°
H8	Brown	25.0 mm 2xM3 @ 180°
H9	Olive	26.2 mm 2xM3 @ 180°
H10	Purple	26.8 mm 2xM3 @ 180°
H11	Black	31.4 mm 2xM3 @ 180°
H12	Light Green	35.0 mm 2xM3 @ 180°
H13	Pink	39.0 mm 3xM3 @ 120°
H14	Dark Red	42.0 mm 3xM3 @ 120°

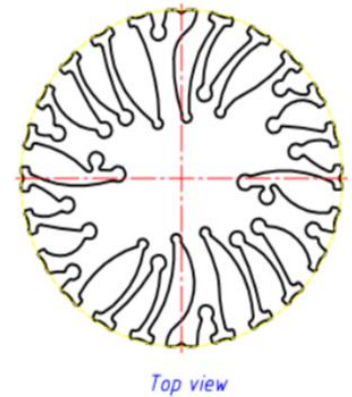
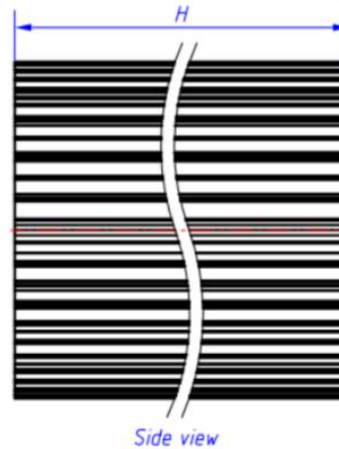
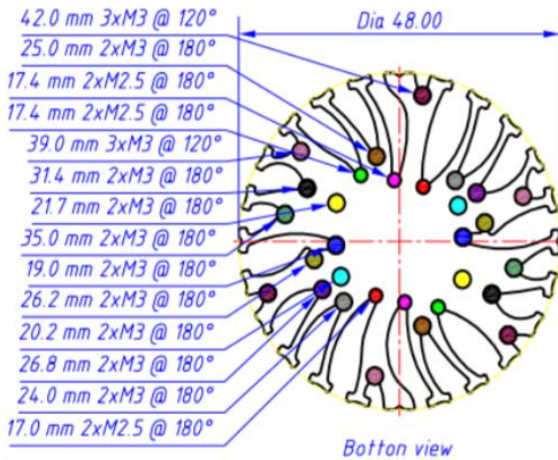

Thermal Data SPIRLED-4850

Dissipated Power Pd(W)	$P_d = P_e \times (1 - \eta_L)$	Heat sink to ambient thermal resistance Rhs-amb (°C/W)	Heat sink to ambient temperature rise Ths-amb (°C)
	2	2	6.5
4	4	6	24
6	6	5.67	34
8	8	5.38	43
10	10	5	50

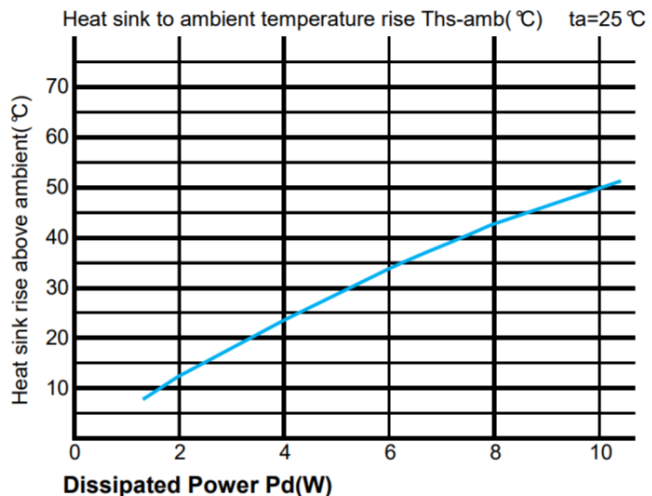

SPIRLED Heat Sink

70mm Diameter

WKV Part Number	Description	Height (mm)	Diameter (mm)	Max. Lumen (lm)	Dissipated Power (W)	Thermal Resistance (°C/W)	Weight (g)
SPIRLED-7050	SPIR LED Heat Sink 70MM DIA 50H	50	70	3200	22.9	2.2	192
SPIRLED-7080	SPIR LED Heat Sink 70MM DIA 80H	80	3900	28.1	1.8	308	

*Note: All Bases Have no Holes



No.	Finish	Mounting Hole
H1	Red	17.5 mm 2xM2.5 @ 180°
H2	Magenta	18.5 mm 2xM2.5 @ 180°
H3	Blue	19.0 mm 2xM3 @ 180°
H4	Cyan	21.5 mm 2xM3 @ 180°
H5	Yellow	24.0 mm 2xM3 @ 180°
H6	Green	25.0 mm 2xM3 @ 180°
H7	Grey	26.2 mm 2xM3 @ 180°
H8	Brown	26.8 mm 2xM3 @ 180°
H9	Olive	31.4 mm 2xM3 @ 180°
H10	Dark Green	32.2 mm 2xM3 @ 180°
H11	Purple	35.0 mm 2xM3 @ 180°
H12	Black	39.0 mm 3xM3 @ 120°
H13	Light Green	42.0 mm 3xM3 @ 120°
H14	Pink	48.0 mm 4xM3 @ 90°
H15	Dark Blue	57.5 mm 4xM3 @ 90°
H16	Light Blue	65.0 mm 4xM3 @ 90° (Fan Hole)

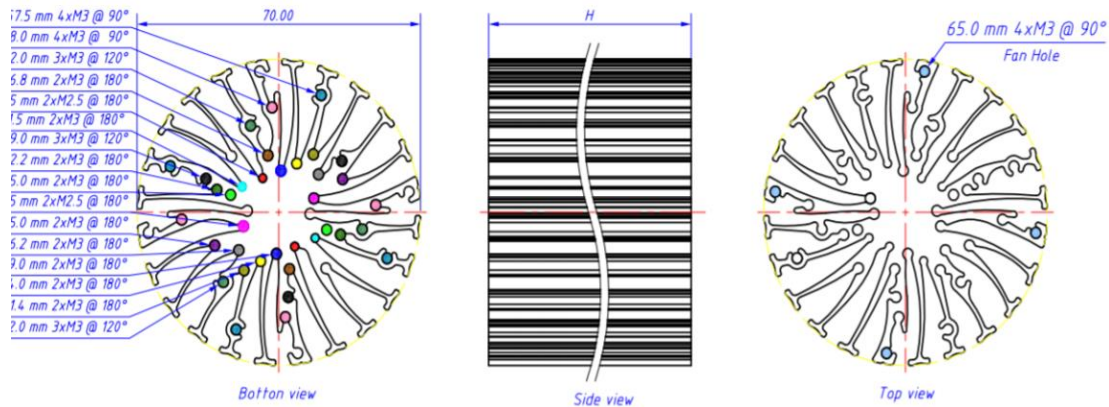

Thermal Data SPIRLED-7050

Dissipated Power Pd(W)	Pd = Pe x (1-ηL)	
	Heat sink to ambient thermal resistance Rhs-amb (°C/W)	Heat sink to ambient temperature rise Ths-amb (°C)
5	3	15
10	2.7	27
15	2.6	39
20	2.5	50
25	2.44	61

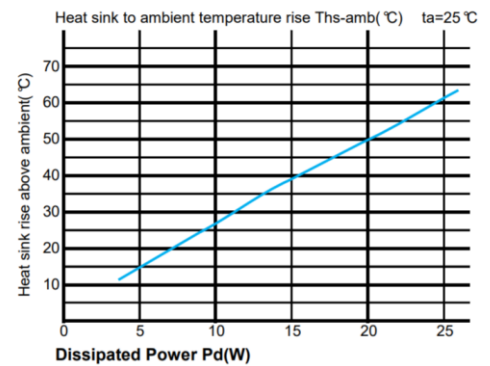

Thermal Data SPIRLED-7080

Dissipated Power Pd(W)	Pd = Pe x (1-ηL)	
	Heat sink to ambient thermal resistance Rhs-amb (°C/W)	Heat sink to ambient temperature rise Ths-amb (°C)
6	3	18
12	2.5	30
18	2.28	41
24	2.08	50
32	1.84	59

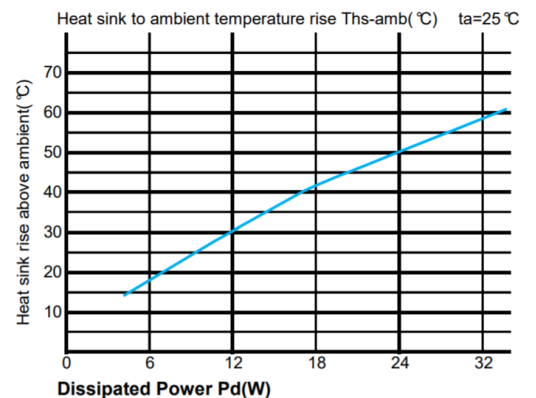

WKV Part Number	Description	Height (mm)	Diameter (mm)	Max. Lumen (lm)	Dissipated Power (W)	Thermal Resistance (°C/W)	Weight (g)
SPIRLED-8550	SPIR LED Heat Sink 85MM DIA 50H	50	85	4700	34	2.2	286
SPIRLED-8580	SPIR LED Heat Sink 85MM DIA 80H	80	5300	38	1.8	458	

*Note: All Bases Have no Holes

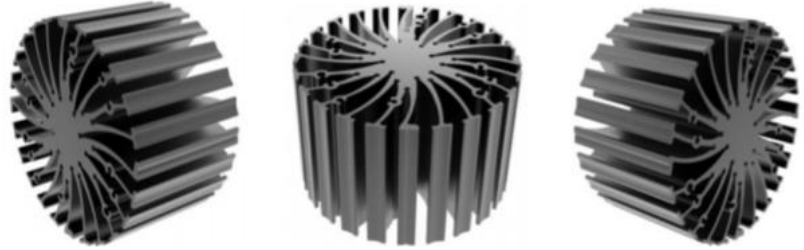

No.	Finish	Mounting Hole
A1	Red	19.0 mm 2xM3 @ 180°
A2	Magenta	20.2 mm 2xM3 @ 180°
A3	Blue	21.7 mm 2xM3 @ 180°
A4	Purple	22.0 mm 2xM2 @ 180°
A5	Cyan	24.0 mm 2xM3 @ 180°
A6	Yellow	25.0 mm 2xM3 @ 180°
A7	Green	26.2 mm 2xM3 @ 180°
A8	Grey	26.8 mm 2xM3 @ 180°
A9	Brown	30.2 mm 2xM3 @ 180°
A10	Olive	31.4 mm 2xM3 @ 180°
A11	Purple	32.2 mm 2xM3 @ 180°
A12	Black	35.0 mm 2xM3 @ 180°
A13	Green	39.0 mm 3xM3 @ 120°
A14	Pink	42.0 mm 3xM3 @ 120°
A15	Purple	55.0 mm 4xM3 @ 90°
A16	Blue	2*56.3 - 2*31 (Ø64.5); 4xM3
A17	Green	66.0 mm 3xM4 @ 120°
A18	Pink	70.5 mm 2xM3 @ 180° (Fan Hole)

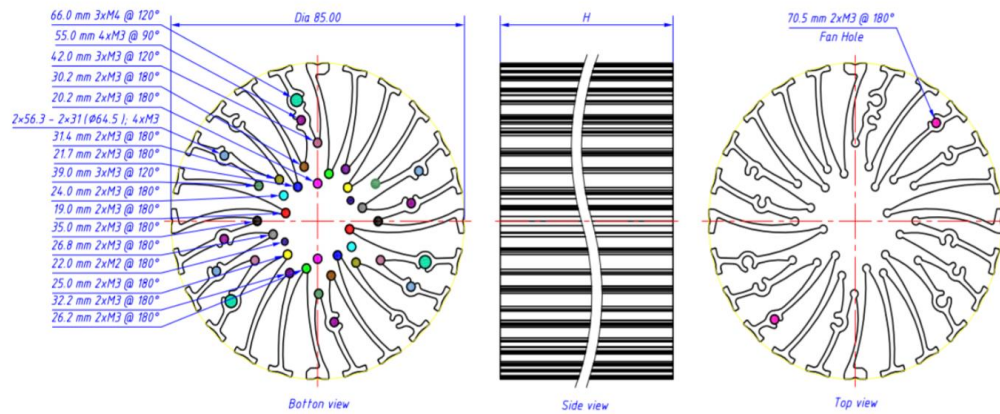

Thermal Data SPIRLED-8550

Dissipated Power Pd(W)	$P_d = P_e \times (1-\eta_L)$	Heat sink to ambient thermal resistance Rhs-amb (°C/W)	Heat sink to ambient temperature rise Ths-amb (°C)
	8		2.88
16		2.19	35
24		1.88	45
32		1.66	53
40		1.53	61

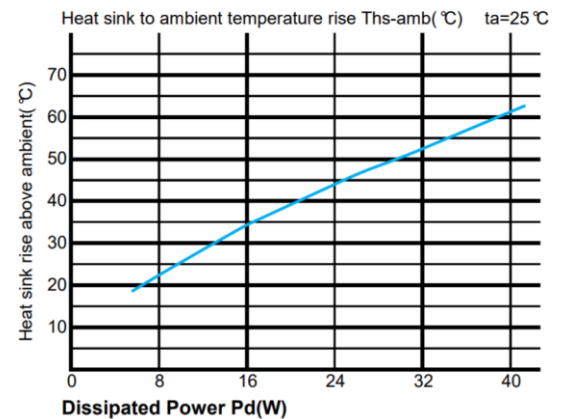

Thermal Data SPIRLED-8580

Dissipated Power Pd(W)	$P_d = P_e \times (1-\eta_L)$	Heat sink to ambient thermal resistance Rhs-amb (°C/W)	Heat sink to ambient temperature rise Ths-amb (°C)
	8		2.25
16		1.88	30
24		1.67	40
32		1.5	48
40		1.4	56

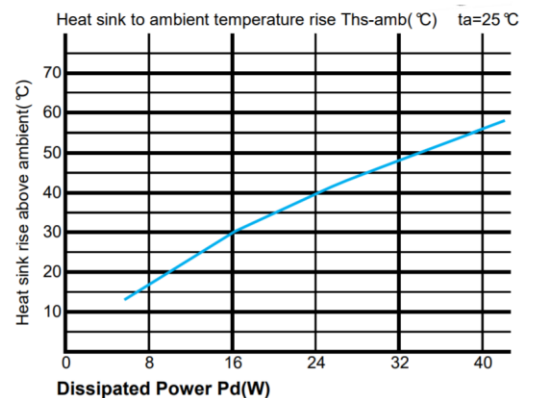

SPIRLED Heat Sink

96mm Diameter

WKV Part Number	Description	Height (mm)	Diameter (mm)	Max. Lumen (lm)	Dissipated Power (W)	Thermal Resistance (°C/W)	Weight (g)
SPIRLED-9650	SPIR LED Heat Sink 96MM DIA 50H	50	96	5200	37.5	1.2	360
SPIRLED-9680	SPIR LED Heat Sink 96MM DIA 80H	80	96	6800	49.2	0.9	575

*Note: All Bases Have no Holes

No.	Finish	Mounting Hole
H1	Red	18.5 mm 2xM3 @ 180°
H2	Green	19.0 mm 2xM3 @ 180°
H3	Blue	24.0 mm 2xM3 @ 180°
H4	Magenta	25.0 mm 2xM3 @ 180°
H5	Cyan	26.2 mm 2xM3 @ 180°
H6	Yellow	26.8 mm 2xM3 @ 180°
H7	Grey	31.4 mm 2xM3 @ 180°
H8	Brown	32.2 mm 2xM3 @ 180°
H9	Light Green	35.0 mm 2xM3 @ 180°
H10	Orange	39.0 mm 3xM3 @ 120°
H11	Olive	42.0 mm 3xM3 @ 120°
H12	Purple	43.0 mm 4xM3 @ 90°
H13	Dark Green	45.2 mm 2xM3 @ 180°
H14	Black	2*38.2-2*31.0 (Ø49.0);6xM3
H15	Orange	57.5mm 4xM3 @ 90°
H16	Dark Blue	58.5mm @ 90°(104°,76°);4xM4
H17	Dark Green	2*56.3-2*31.0 (Ø64.2);4xM3
H18	Brown	68.0 mm 4xM3 @ 90°
H19	Magenta	79.5 mm 3xM3 @ 120°
H20	Light Blue	82.0 mm 4xM3 @ 90° (Fan Hole)

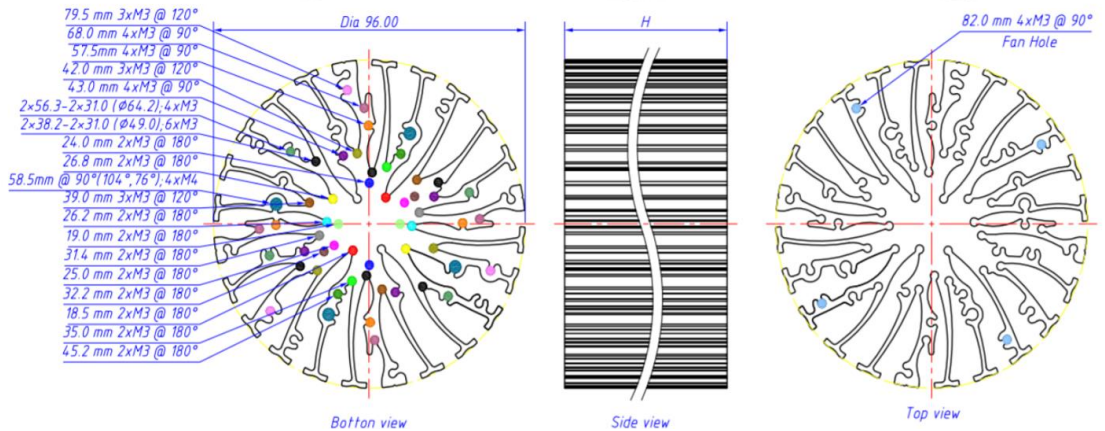
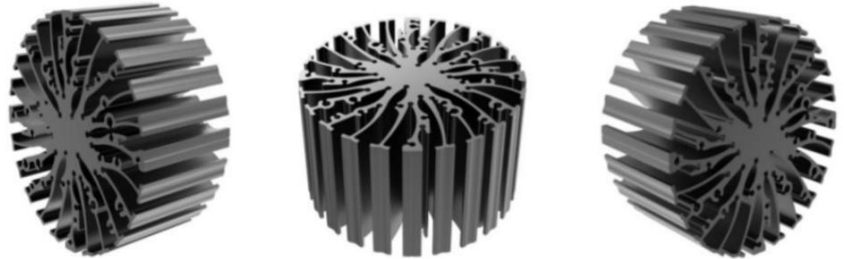

Thermal Data SPIRLED-9650

Dissipated Power Pd(W)	Pd = Pe x (1-ηL)	Heat sink to ambient thermal resistance Rhs-amb (°C/W)	Heat sink to ambient temperature rise Ths-amb (°C)
	8	2.25	18
16	1.88	30	
24	1.67	40	
32	1.5	48	
40	1.4	56	

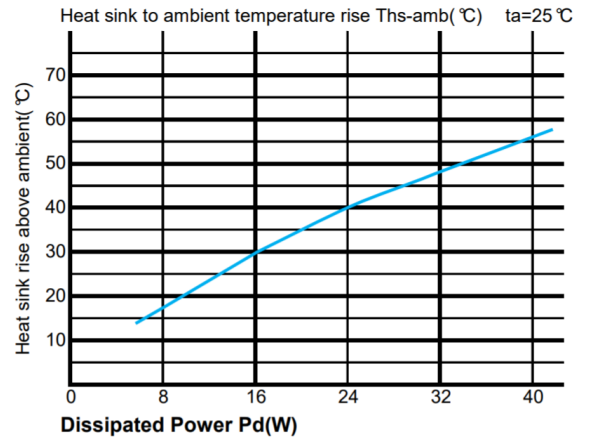

Thermal Data SPIRLED-9680

Dissipated Power Pd(W)	Pd = Pe x (1-ηL)	Heat sink to ambient thermal resistance Rhs-amb (°C/W)	Heat sink to ambient temperature rise Ths-amb (°C)
	10	1.7	17
20	1.45	29	
30	1.33	40	
40	1.2	48	
50	1.12	56	

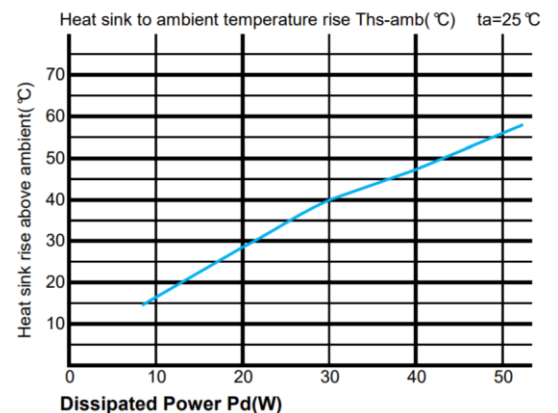

WKV Part Number	Description	Height (mm)	Diameter (mm)	Max. Lumen (lm)	Dissipated Power (W)	Thermal Resistance (°C/W)	Weight (g)
SPIRLED-11050	SPIR LED Heat Sink 110MM DIA 50H	50	110	6700	48	1.1	414
SPIRLED-11080	SPIR LED Heat Sink 110MM DIA 80H	80	7900	57	0.9	662	

***Note: All Bases Have no Holes**

No.	Finish	Mounting Hole
H1	●	22.0 mm 2xM2 @ 180°
H2	●	24.0 mm 2xM3 @ 180°
H3	●	25.0 mm 2xM3 @ 180°
H4	●	26.8 mm 2xM3 @ 180°
H5	●	30.2 mm 2xM3 @ 180°
H6	●	31.4 mm 2xM3 @ 180°
H7	●	32.2 mm 2xM3 @ 180°
H8	●	35.0 mm 2xM3 @ 180°
H9	●	37.7 mm 2xM3 @ 180°
H10	●	39.0 mm 3xM3 @ 120°
H11	●	42.0 mm 3xM3 @ 120°
H12	●	43.0 mm 4xM3 @ 90°
H13	●	45.2 mm 2xM3 @ 180°
H14	●	57.4 mm 4xM3 @ 90°
H15	●	58.5 mm 4xM3.5 @ 90°
H16	●	79.5 mm 4xM3 @ 90°
H17	●	99.5 mm 2xM3 @ 90°

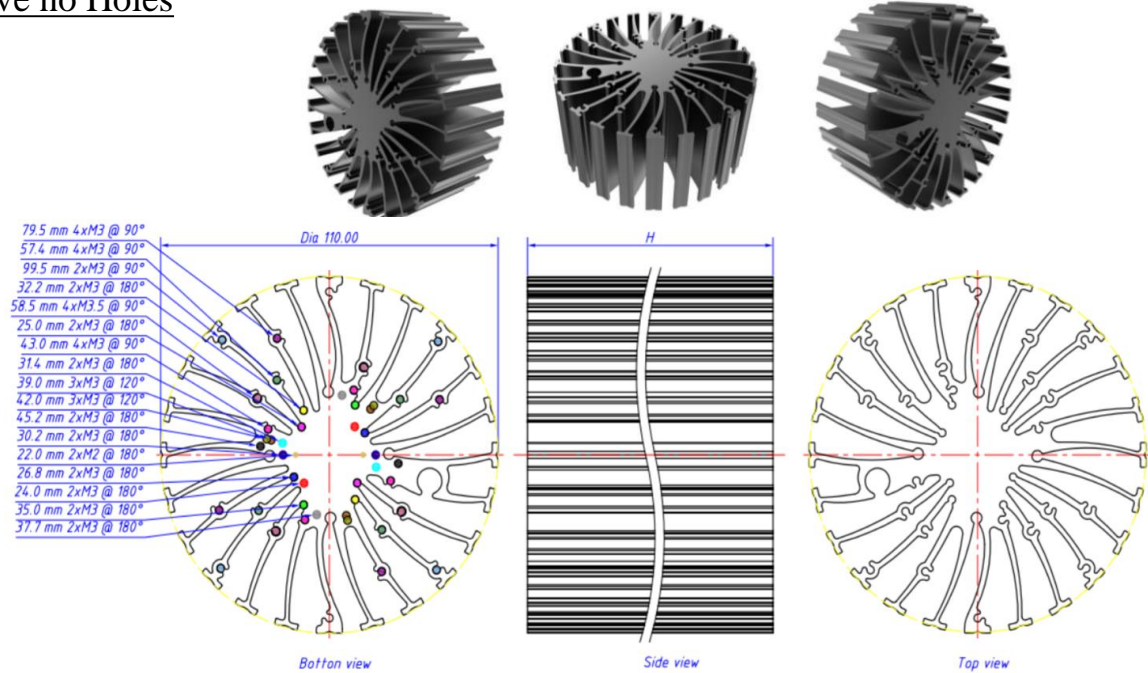

Thermal Data SPIRLED-11050

Dissipated Power Pd(W)	$P_d = P_e \times (1-\eta_L)$	Heat sink to ambient thermal resistance Rhs-amb (°C/W)	Heat sink to ambient temperature rise Ths-amb (°C)
	10	1.6	16
20	1.4	28	
30	1.33	40	
40	1.23	49	
50	1.16	58	

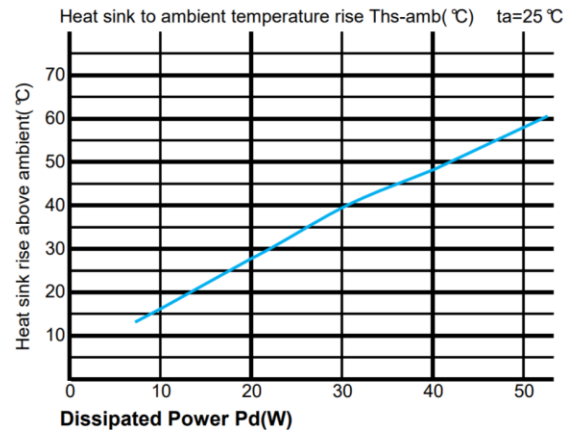

Thermal Data SPIRLED-11080

Dissipated Power Pd(W)	$P_d = P_e \times (1-\eta_L)$	Heat sink to ambient thermal resistance Rhs-amb (°C/W)	Heat sink to ambient temperature rise Ths-amb (°C)
	12	1.33	16
24	1.21	29	
36	1.11	40	
48	1.03	49.5	
60	0.95	57	

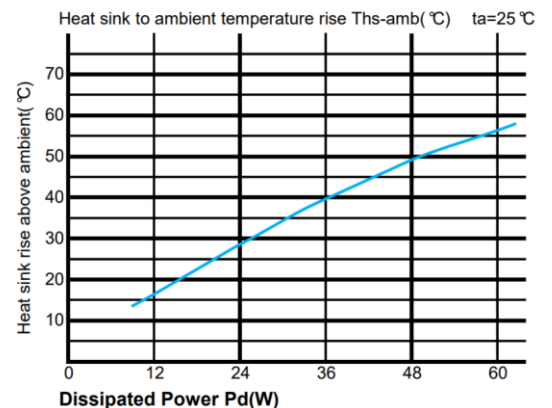

STRTLED Heat Sink

Wakefield- Vette's STRTLED radial aluminum extrusion that makes the convection heat dissipation reasonable. This is compatible with Light Modules such as Edison, Xicato, Bridgelux, Osram, Lumileds, Cree, Tridonic, LG, Lustrous, Prolight, Samsung, SHARP, Luminus and Philips.



Features:

- Mechanical compatibility with direct mounting of the LED modules to the LED cooler and thermal performance matching the lumen packages
- Several Diameters, Several Standard heights
- Extruded from highly conductive aluminum
- Black Anodized
- Blank surface with no holes to mount any device listed below

Compatible with:

- Xicato XSM, XIM,XTM
- Bridgelux ESS, ESR, Vero 10, Vero 13, Vero 18 V-series
 - Citizen CLL024-CLU028, CLL034-CLU038
 - Cree XLamp CXA13xx, CXA15xx, CSA18xx
- Lumileds Luxeon COB's 1203, 1204, 1205, Luxeon K arrays K12, K16
- Osram PrevaLED Core, SOLERIQ P and SOLERIQ S LED engines
 - Seoul Semiconductor ZC6, ZC12, ZC18, ZC25
 - Tridonic TALEXX module SLE modules
 - LG Innotek LEMWM18 10W, 13W, 17W
- Edison EdiLex SLM and EdiLex II COB LED engines
- Lustrous LUSTRON 6 series LL604F, LL608D, LL613F, LL620F
 - Prolight Opto PABS, PABA, PACB, PANA
 - Samsung LC013, LC019, LC026 COB LED engines
- SHARP Mini Zenigata Intermo and Mega Zenigata LED engines
 - Philips Fortimo SLM LED engines
 - Vossloh-Schwabe LUGA Shop LED engines
 - Luminus C##9, C##14 LED engines

WKV Part Number	Description	Height (mm)	Diameter (mm)	Max. Lumen (lm)	Dissipated Power (W)	Thermal Resistance (°C/W)	Weight (g)
STRTLED-4650	STRT LED Heat Sink 46MM DIA 50H	50	46	1400	10	5	101

*Note: All Bases Have no Holes

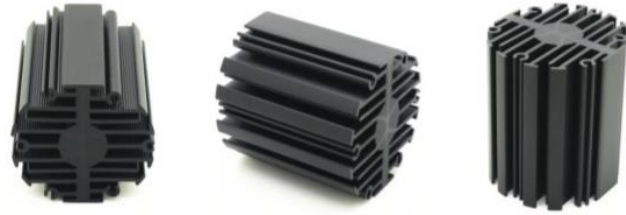

No.	Finish	Mounting Hole
A1	●	17.0 mm 2xM3 @ 180°
A2	●	19.0 mm 2xM3 @ 180°
A3	●	21.7 mm 2xM3 @ 180°
A4	●	22.0 mm 2xM3 @ 180°
A5	●	24.0 mm 2xM3 @ 180°
A6	●	25.0 mm 2xM3 @ 180°
A7	●	26.0 mm 2xM3 @ 180°
A8	●	26.8 mm 2xM3 @ 180°
A9	●	31.4 mm 2xM3 @ 180°
A10	●	35.0 mm 2xM3 @ 180°
A11	●	39.0 mm 3xM3 @ 120°
A12	●	42.0 mm 3xM3 @ 120°

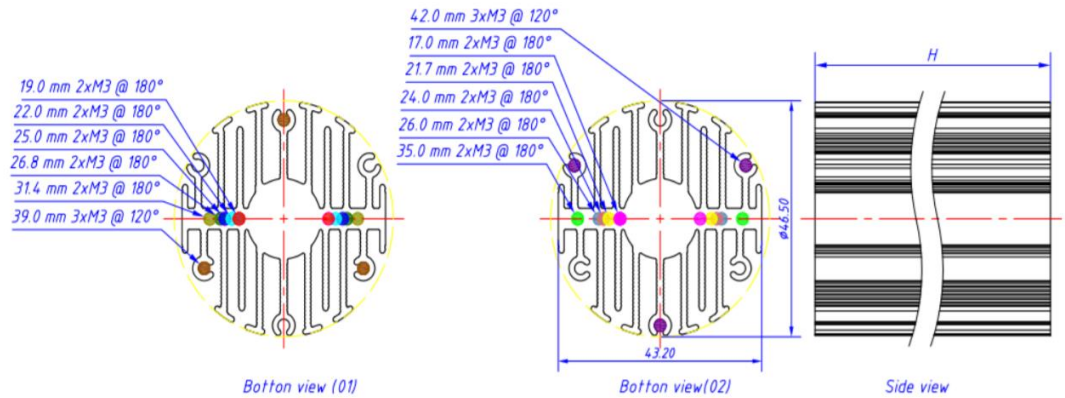

Thermal Data STRTLED-4650

Dissipated Power Pd(W)	$P_d = P_e \times (1-\eta_L)$	Heat sink to ambient thermal resistance Rhs-amb (°C/W)	Heat sink to ambient temperature rise Ths-amb (°C)
	3		5.67
6		5.5	33
9		5.22	47
12		4.83	58
15		4.33	65

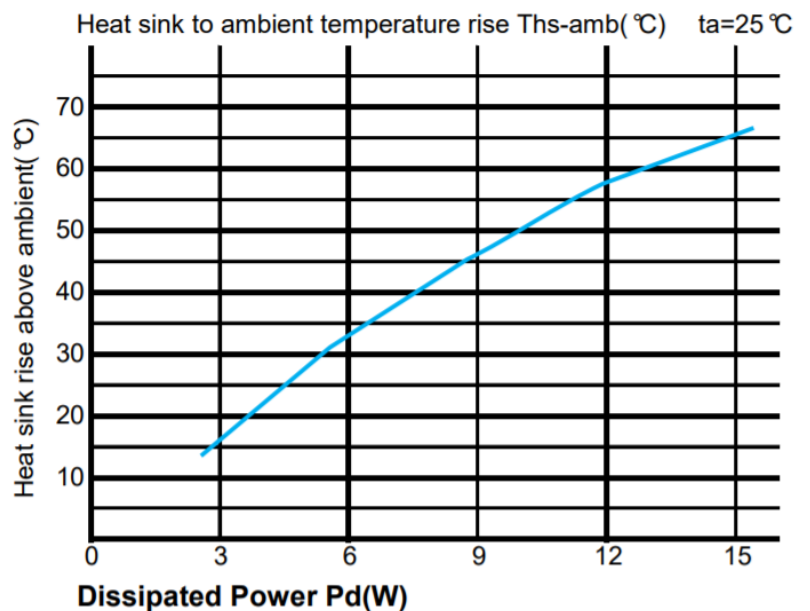

STRTLED Heat Sink

70mm Diameter

WKV Part Number	Description	Height (mm)	Diameter (mm)	Max. Lumen (lm)	Dissipated Power (W)	Thermal Resistance (°C/W)	Weight (g)
STRTLED-7050	STRT LED Heat Sink 70MM DIA 50H	50	70	3200	22.9	2.1	206

*Note: All Bases Have no Holes

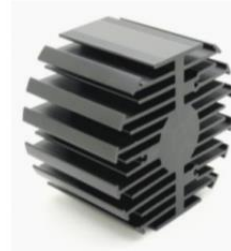

No.	Finish	Mounting Hole
A1		17.0 mm 2xM3 @ 180°
A2		19.0 mm 2xM3 @ 180°
A3		21.7 mm 2xM3 @ 180°
A4		22.0 mm 2xM3 @ 180°
A5		24.0 mm 2xM3 @ 180°
A6		25.0 mm 2xM3 @ 180°
A7		26.2 mm 2xM3 @ 180°
A8		26.8 mm 2xM3 @ 180°
A9		27.0 mm 2xM3 @ 180°
A10		31.4 mm 2xM3 @ 180°
A11		35.0 mm 2xM3 @ 180°
A12		39.0 mm 3xM3 @ 120°

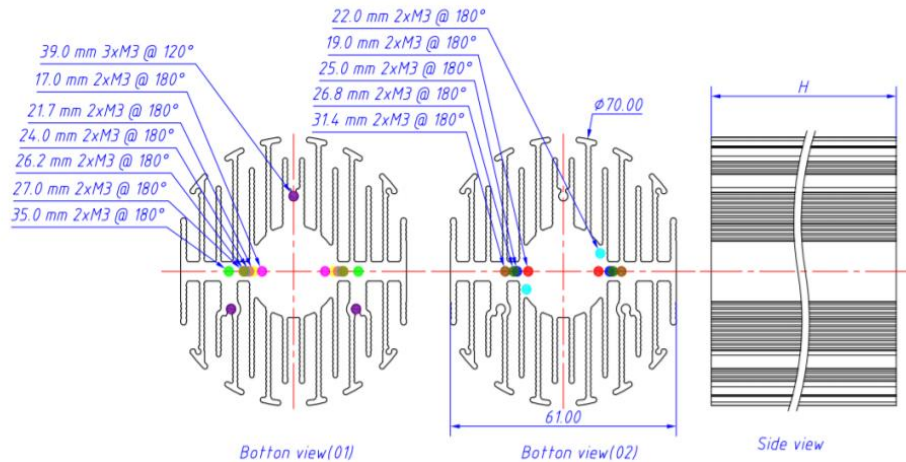

Thermal Data STRTLED-7050

Dissipated Power Pd(W)	$P_d = P_e \times (1-\eta_L)$	Heat sink to ambient thermal resistance Rhs-amb (°C/W)	Heat sink to ambient temperature rise Ths-amb (°C)
	5	3.4	17
10	2.8	28	
15	2.7	37	
20	2.25	45	
25	2.16	54	

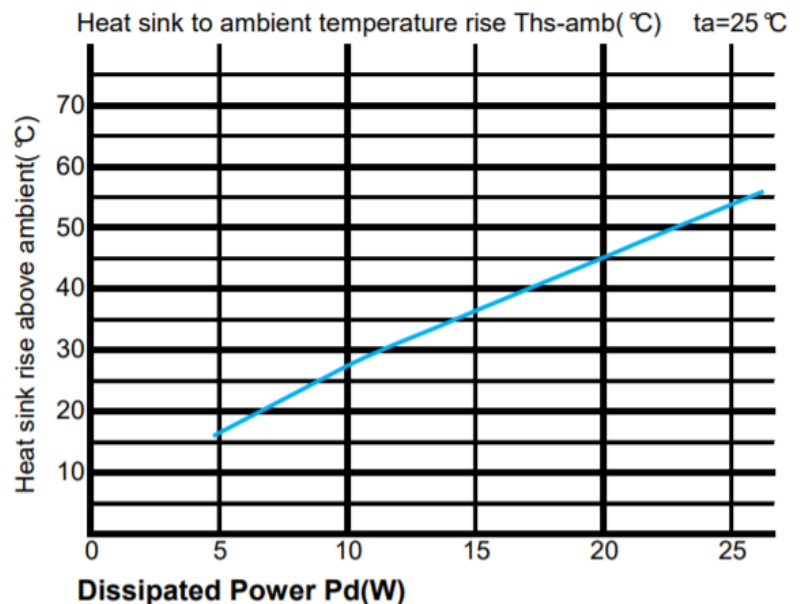

WKV Part Number	Description	Height (mm)	Diameter (mm)	Max. Lumen (lm)	Dissipated Power (W)	Thermal Resistance (°C/W)	Weight (g)
STRTLED-9550	STRT LED Heat Sink 95MM DIA 50H	50	95	5600	40.5	1.25	353

***Note: All Bases Have no Holes**

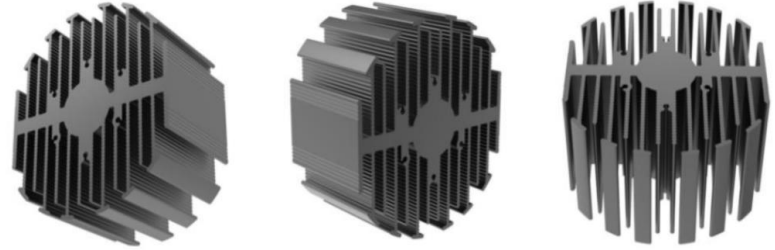

No.	Finish	Mounting Hole
A1	Red	19.0 mm 2xM3 @ 180°
A2	Blue	21.7 mm 2xM3 @ 180°
A3	Green	22.0 mm 2xM3 @ 180°
A4	Yellow	24.0 mm 2xM3 @ 180°
A5	Purple	25.0 mm 2xM3 @ 180°
A6	Orange	26.2 mm 2xM3 @ 180°
A7	Pink	26.8 mm 2xM3 @ 180°
A8	Light Blue	27.0 mm 2xM3 @ 180°
A9	Light Green	30.2 mm 2xM3 @ 180°
A10	Light Yellow	30.2 mm 2xM3 @ 180°
A11	Light Purple	33.0 mm 2xM3 @ 180°
A12	Light Orange	33.3 mm 2xM3 @ 180°
A13	Light Red	35.0 mm 2xM3 @ 180°
A14	Light Blue	37.7 mm 2xM3 @ 180°
A15	Light Green	45.0 mm 2xM3 @ 180°
A16	Light Yellow	45.2 mm 2xM3 @ 180°
A17	Light Purple	39.0 mm 3xM3 @ 120°
A18	Light Orange	42.0 mm 3xM3 @ 120°

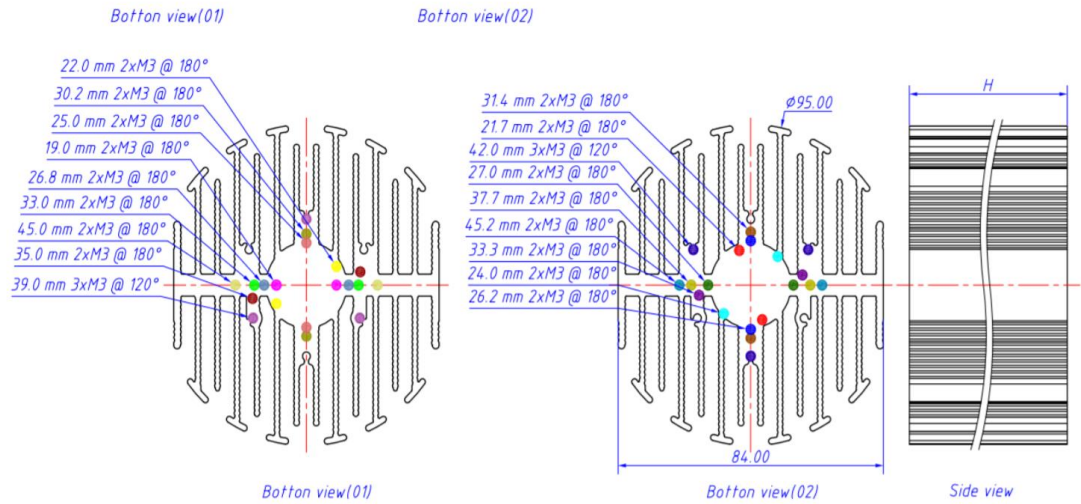

Thermal Data STRTLED-9550

Dissipated Power Pd(W)	$P_d = P_e \times (1-\eta_L)$	Heat sink to ambient thermal resistance Rhs-amb (°C/W)	Heat sink to ambient temperature rise Ths-amb (°C)
	10	1.8	18
20	1.4	28	
30	1.3	39	
40	1.25	50	
50	1.18	59	

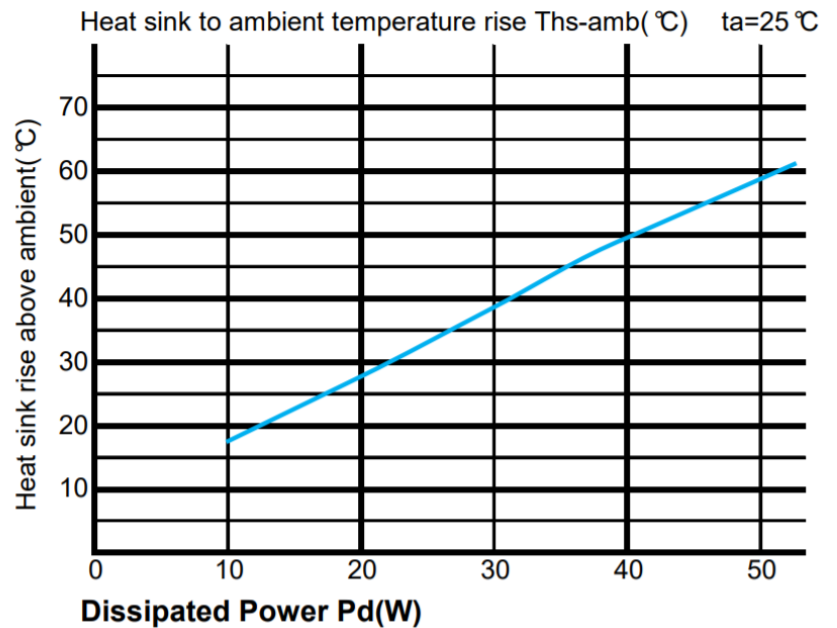

THERMAL SELECTION GUIDELINES

CUSTOM RADIAL-FIN HEAT SINKS BRIDGELUX LED Light Engines

Background:

Continued growth of BRIDGELUX LED lighting products has created a very real need for design and usage guidelines aimed specifically at helping engineers and designers select heat sink products based on both space constraints and operating parameters.

WAKEFIELD SOLUTIONS has been working in conjunction with BRIDGELUX to develop a new product line of Custom Radial-Fin Heat Sinks – designed specifically for the complete family of BRIDGELUX LED Light Engines being marketed through NEWARK element 14.

Summary Table 1:

	BRIDGELUX P/N	Form factor	ORDERABLE P/N	HS Length	Thermal	HS TR	T RISE
				(in)	(W)	(C/W)	(C)
1	BXRA-N3500-00000	RS Rectangle	19754-M-AB	7.50	23.3	0.68	15.9
	BXRA-C4500-00000	RS Rectangle	19754-M-AB	7.50	34.5	0.68	23.5
	BXRA-W3000-00000	RS Rectangle	19754-M-AB	7.50	42.8	0.68	29.2
2	BXRA-C0802-00000	Rectangle	19755-S-AB	2.75	11.3	2.20	24.7
3	BXRA-W0802-00000	Rectangle	19755-M-AB	4.00	15.0	1.82	27.3
4	BXRA-W1202-00000	Rectangle	19755-L-AB	6.00	18.8	1.49	27.9
5	BXRA-W1203-00000	Rectangle	19755-XL-AB	8.00	22.5	1.29	29.0
6	BXRA-C2002-00000	Rectangle	19755-XXL-AB	10.00	26.3	1.15	30.2
	BXRA-C1202-00000	Rectangle	19755-M-AB	4.00	15.0	1.82	27.3
	BXRA-N0802-00000	Rectangle	19755-M-AB	4.00	15.0	1.82	27.3
	BXRA-N1203-00000	Rectangle	19755-XL-AB	8.00	22.5	1.29	29.0
7	BXRA-C0402-0000	Star	19756-S-AB	2.00	4.1	3.03	12.5
8	BXRA-W0402-0000	Star	19756-M-AB	2.75	5.6	2.48	13.9
9	BXRA-W0401-0000	Star	19756-L-AB	3.00	7.5	2.59	19.4
10	BXRA-W0403-00000	Star	19756-XL-AB	3.25	9.0	2.38	21.4
	BXRA-C0603-00000	Star	19756-XL-AB	3.25	9.0	2.38	21.4
11	BXRA-W0260-00000	LS	19757-S-AB	2.75	3.0	3.55	10.7
12	BXRA-C0360-00000	LS	19757-M-AB	3.00	3.8	3.40	12.8
13	BXRA-C0361-00000	LS	19757-L-AB	3.25	4.5	3.27	14.7
	BXRA-W0261-00000	LS	19757-S-AB	2.75	3.0	3.55	10.7
	BXRA-W0240-00000	LS	19757-M-AB	3.00	3.8	3.40	12.8
	BXRA-W0241-00000	LS	19757-L-AB	3.25	4.5	3.27	14.7
14	Helieon 1200LM	Helieon	19758-M-AB	7.00	24.0	1.15	27.7

Note – although there are 23 specific BRIDGELUX LED light options – there are only 14 Custom Wakefield Solutions Rad-Fin Heat Sink part numbers required to support the complete product line.

The Orderable P/Ns are made up of the unique extrusion profile number, followed by the product length, (i.e. S=Short, M=Medium, L=Length etc...), and finally the finish designation, (AB=Anodized Black).

The last column “T Rise” contains the estimated temperature rise above ambient, (i.e. room temperature), for a given WAKEFIELD Radial-Fin Heat Sink assembled with the associated BRIDGELUX LED. These values – T Rise and T Ambient - are added to determine the estimated LED Substrate temperature.

All WAKEFIELD Rad-Fin Heat Sink Lengths were derived using this T Rise with a T Ambient with a standard T Ambient of 40 degrees C maximum – with the objective to yield a maximum LED Substrate temperature of 70 degrees C or less.

This 70 degrees C maximum LED Substrate operating temperature has been specified by BRIDGELUX as the highest temperature permissible to achieve the expected LED light quality, (full lumens), for the extended life of 50,000 hours.

Sample Calculations:

To calculate the expected LED Substrate Temperature using a specific Rad-Fin Heat Sink ...

Select the Rad-Fin Heat Sink in Summary Table 1 ... go across to the columns to the second column in from the right – HS TR (C/W) – this column indicates the Heat Sink Thermal Resistance Values for each specific heat sink – in degrees Centigrade Temperature Rise per Watt of Thermal Load (W) in Natural Convection, (no fan).

Next ... look at the value in the third column from the right – THERMAL (W) – this is the Maximum Thermal Load Value for the specific BRIDGELUX LED.

The product of multiplying these two values – is the expected temperature rise above ambient for the particular LED Substrate and Heat Sink combination:

$$HS\ TR\ (C/W) \times THERMAL\ (W) = T\ Rise\ (C)$$

T Rise Values are found in the first column from the right in Summary Table 1.

For BRIDGELUX LED BXRA-W0802-00000 – WAKEFIELD Rad-Fin Heat Sink **19755-M-AB**:

Table 2:

	BRIDGELUX	SERIES	ORDERABLE	HS Length	HS Length	HS Diameter	HS Diameter	Thermal	HS TR	T RISE
	P/N		P/N	(in)	(mm)	(in)	(mm)	(W)	(C/W)	(C)
3	BXRA-W0802-00000	Rectangle	19755-M-AB	4	101.6	2.5	63.5	15	1.82	27.3

$$HS\ TR\ (C/W) \times THERMAL\ (W) = T\ Rise\ (C)$$

$$1.82\ C/W \times 15\ W = 27.3\ C\ T\ Rise\ above\ Ambient\ Temperature$$

NOTE: BRIDGELUX has chosen 40 degrees C as the maximum expected Ambient Temperature – the “Standard” Rad-Fin Heat Sink Lengths indicated in Summary Table 1 were determined based on this 40 C Max Ambient Temperature and “Specified” 70 C Max LED Substrate Temperature.

Therefore, the LED Substrate Max Temperature is the Sum of:

$$Max\ T\ Rise + Max\ T\ Ambient = Max\ LED\ Substrate\ Temperature$$

$$27.3\ C\ T\ Rise + 40\ C\ T\ Ambient = 67.3\ C\ T\ LED\ Substrate\ Temperature$$

Can shorter length Rad-Fin Heat Sinks be used successfully?

YES - assuming the Maximum Ambient temperature is less than 40 degrees C - a shorter length heat sink within the same product family can be substituted.

Example:

In the case where Max T Ambient is expected to be less than 40 C – for example - assuming a Max T Ambient of 35 C – it would be possible to use a shorter length Rad-Fin Heat Sink.

Could the “next size down” Rad-Fin Heat Sink - 19755-S-AB - be used?

$$HS TR (C/W) \times THERMAL (W) = T Rise (C)$$

$$2.2 C/W \times 15 W = 33 C T Rise above Ambient Temperature$$

Therefore, the LED Substrate Max Temperature is the Sum of:

$$Max T Rise + Max T Ambient = Max LED Substrate Temperature$$

$$33 C T Rise + 35 C T Ambient = 68 C T LED Substrate Temperature$$

Example Summary:

Five Rad-Fin Heat Sink Lengths were manufactured for the BRIDGELUX “Rectangular” Form Factor LED Light Engine Family;

1. S = Short
2. M= Medium
3. L= Long
4. XL= Extra Long
5. XXL = Extra Extra Long

Summary Table 3:

BRIDGELUX P/N	Form	ORDERABLE	HS	T SUB	ORDERABLE	T SUB
	Factor	P/N	Length	40C Amb	P/N	35C Amb
			(in)	(C)		(C)
BXRA-C0802-00000	Rectangle	19755-S-AB	2.75	64.86	19755-S-AB	59.86
BXRA-W0802-00000	Rectangle	19755-M-AB	4	67.30	19755-S-AB	68.00
BXRA-W1202-00000	Rectangle	19755-L-AB	6	68.01	19755-M-AB	69.22
BXRA-W1203-00000	Rectangle	19755-XL-AB	8	69.03	19755-L-AB	73.53
BXRA-C2002-00000	Rectangle	19755-XXL-AB	10	70.25	19755-XL-AB	68.93
BXRA-C1202-00000	Rectangle	19755-M-AB	4	67.30	19755-S-AB	68.00
BXRA-N0802-00000	Rectangle	19755-M-AB	4	67.30	19755-S-AB	68.00
BXRA-N1203-00000	Rectangle	19755-XL-AB	8	69.03	19755-L-AB	68.53

From the previous example **BXRA-W0802-00000 – WAKEFIELD Rad-Fin Heat Sink 19755-M-AB** :

The first temperature column -

- T SUB 40C Amb – indicates the LED Substrate temperatures for the “Standard” length heat heats at 40 C Ambient Temperature = **67.3 C**.

The second temperature column -

- T SUB 35C Amb – indicates the LED Substrate temperatures for the “Reduced” length heat sinks at 35 C Ambient Temperature = **68.0 C**.

Summary Graph 1:

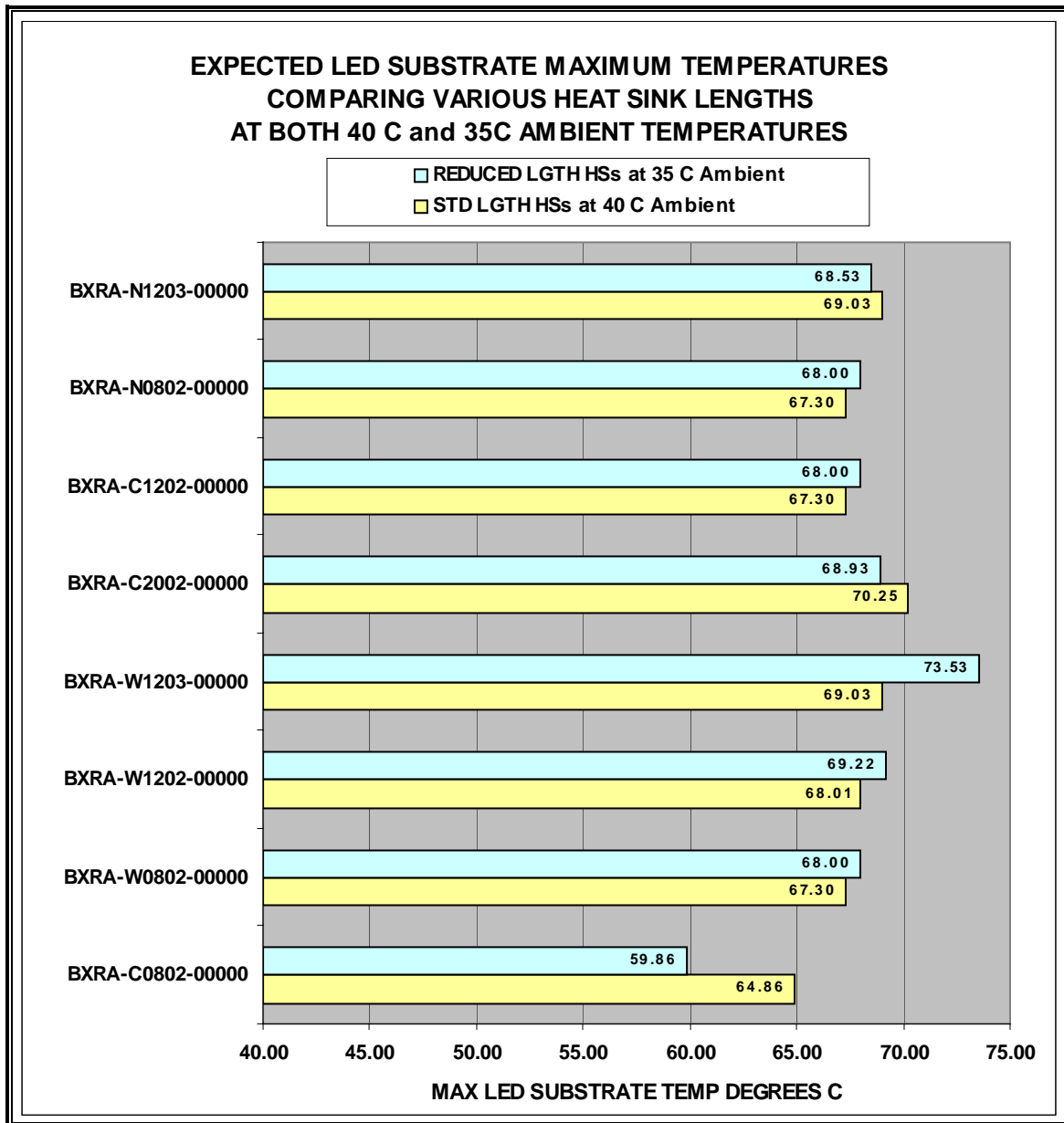

Conclusion:

This Summary Graph 1 overview of the - WAKEFIELD 19755 Rad-Fin Heat Sink Profile - indicates that for all products except BXRA-W1203-0000 – it would be possible to use the “next size down” length Rad-Fin Heat Sink if the Max T Ambient is reduced from the specified 40 C to 35 C and still maintain a Max T Substrate below the BRIDGELUX specified 70 C Maximum.

Knowing the specific values from Summary Table 1:

- Heat Sink Thermal Resistance Values – HS TR (C/W)
- LED Thermal Load – THERMAL (W)

The Temperature Rise – Max T Rise (C) – can be calculated.

By adding this Max T Rise to the Max Ambient Temperature the Max LED Substrate Temperature can be estimated – this will enable the selection of the minimum size Rad-Fin Heat Sink for a specific application.

$$\text{Max T Rise (C)} + \text{Max T Ambient (C)} = \text{Max T LED Substrate}$$